

UNIVERSITY OF TORONTO

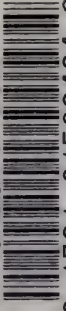

3 1761 01509424 6

UNIV. OF
TORONTO
LIBRARY





Digitized by the Internet Archive
in 2007 with funding from
Microsoft Corporation

H
H6734

History of all nations

ANCIENT GREECE

BY

GUSTAV FRIEDRICH HERTZBERG, PH. D.

HONORARY PROFESSOR OF HISTORY IN THE UNIVERSITY OF HALLE, AUTHOR OF
"GREECE UNDER ROMAN RULE," "HELLAS AND ROME," "THE BYZANTINES
AND THE OTTOMAN EMPIRE," "THE ROMAN EMPIRE," ETC.

AND

WILLIAM NICKERSON BATES, PH. D. (HARV.)

ASSISTANT PROFESSOR OF GREEK IN THE UNIVERSITY OF PENNSYLVANIA

TRANSLATED UNDER THE SUPERVISION OF

JOHN HENRY WRIGHT, LL. D.

PROFESSOR OF GREEK IN HARVARD UNIVERSITY AND DEAN OF THE GRADUATE SCHOOL,
EDITOR-IN-CHIEF OF THE "AMERICAN JOURNAL OF ARCHAEOLOGY, SECOND SERIES"

VOLUME III

OF

A HISTORY OF ALL NATIONS

///

689.00
13/3/06



LEA BROTHERS & COMPANY
PHILADELPHIA AND NEW YORK

14
D
20
H57
1905
v.3

Entered according to Act of Congress, in the year 1905, by

LEA BROTHERS & CO.,

In the Office of the Librarian of Congress, at Washington. All rights reserved.

ELECTROTYPED BY
WESTCOTT & THOMSON, PHILADA.

PRESS OF
WILLIAM J. DORNAN, PHILADA.

GENERAL CONTENTS.

(FOR ANALYTICAL CONTENTS, SEE PAGE 423.)

BOOK I.

FROM THE PELASGIC PERIOD TO THE PERSIAN WARS.

PART I.

FROM THE EARLIEST PERIOD OF GREEK HISTORY TO THE
FIRST OLYMPIAD (TO 776 B.C.).

CHAPTER I.

LAND OF THE GREEKS PAGE
19

CHAPTER II.

PELASGIANS, ACHAEANS, AND HELLENES 27

CHAPTER III.

THE THESSALO-DORIAN MIGRATION AND ITS RESULTS 56

PART II.

FROM THE FIRST OLYMPIAD TO THE REVOLT OF ARISTA-
GORAS OF MILETUS (776-500 B.C.).

CHAPTER IV.

THE COLONIAL EXPANSION OF THE GREEKS 83

CHAPTER V.

GREECE IN THE TIME OF PATRICIAN RULE 98

CHAPTER VI.

TYRANNY, TIMOCRACY, DEMOCRACY 111

CHAPTER VII.

	PAGE
SPARTA AND ATHENS IN THE SIXTH CENTURY B.C.	120

CHAPTER VIII.

THE CONQUEST OF ASIATIC GREECE BY THE PERSIANS.—WESTERN GREECE	151
----------------------------------------------------------------	-----

BOOK II.

FROM THE BEGINNING OF THE PERSIAN WARS TO THE
BATTLE OF MANTINEA (500–362 B.C.).

PART III.

FROM THE IONIAN REVOLT TO THE BEGINNING OF THE
PELOPONNESIAN WAR (500–432 B.C.).

CHAPTER IX.

THE PERSIAN WARS	169
----------------------------	-----

CHAPTER X.

THE PERIOD OF PAN-HELLENIC UNITY (478–461 B.C.)	204
-----------------------------------------------------------	-----

CHAPTER XI.

THE AGE OF PERICLES (460–430 B.C.)	217
----------------------------------------------	-----

PART IV.

FROM THE BEGINNING OF THE PELOPONNESIAN WAR TO
THE BATTLE OF MANTINEA (431–362 B.C.).

CHAPTER XII.

THE PELOPONNESIAN WAR	251
---------------------------------	-----

CHAPTER XIII.

SPARTAN SUPREMACY UNTIL THE PEACE OF ANTALCIDAS (404–387 B.C.)	291
--------------------------------------------------------------------------	-----

CHAPTER XIV.

CULMINATION AND SPEEDY DECLINE OF THE SPARTAN POWER.—RISE OF THEBES.—THE SECOND ATHENIAN CONFEDERATION.	309
--------------------------------------------------------------------------------------------------------------------	-----

BOOK III.

THE MACEDONIAN AGE (362-217 B.C.).

PART V.

THE MACEDONIAN SUPREMACY AND ALEXANDER'S SUCCESSORS (362-277 B.C.).

CHAPTER XV.

FROM MANTINEA TO CHAERONEA	PAGE 337
--------------------------------------	-------------

CHAPTER XVI.

ALEXANDER THE GREAT.—THE LAMIAN WAR	361
-----------------------------------------------	-----

CHAPTER XVII.

THE AGE OF THE DIADOCHI	387
-----------------------------------	-----

PART VI.

THE AGE OF THE EPIGONI (277-217 B.C.).

CHAPTER XVIII.

THE STATES OF THE EPIGONI	397
-------------------------------------	-----

CHAPTER XIX.

THE ANTIGONIDAE.—THE AETOLIAN AND THE ACHAEAN LEAGUES	404
-----------------------------------------------------------------	-----

APPENDIX—CNOSSUS AND PHAESTUS	411
-----------------------------------------	-----

ANALYTICAL CONTENTS	423
-------------------------------	-----

LIST OF ILLUSTRATIONS.

FIGURE	PAGE
1. Ancient oracle-plaque of thin lead from Dodona. (After Karapanos.)	29
2. Ancient oracle-plaque of thin lead from Dodona. (After Karapanos.)	29
3. Colossal Statue of Hercules. Copied by Glycon after a work of Lysippus. Found in the Baths of Caracalla. Marble. Museum at Naples. (From photograph.)	34
4. Typical wall of the Second City, Troy	35
5. Walls of the Sixth City, Troy. In the foreground, to the right, part of a tower	36
6. Ideal marble bust of Homer. Sansouci, Berlin. (From a photograph.)	37
7. Ruins of the Acropolis of Mycenae. (After Gailhabaud.)	40
8. Entrance to the Treasury of Atreus in Mycenae. (After Gailhabaud.)	41
9. Interior view of the Treasury of Atreus in Mycenae. (After Gailhabaud.)	42
10, 11. Section of the Treasury of Atreus. (After Gailhabaud.)	42
12-21. Objects discovered at Mycenae. (After Schliemann.)	43
12. A wooden button plated with gold, intagliated and embossed	43
13. Gold bracelet	43
14. Elegant gold crown	43
15, 16, 17. Gold chased ornaments representing two swans, a hippocampus, and a butterfly	43
18. Bronze sword	43
19, 20.-Spirals made of gold wire	43
21. Vase of terra-cotta	43
22-29. Other objects discovered at Mycenae. (After Schliemann.)	44
22. Silver pitcher	44
23. Massive gold goblet with two handles	44
24. Ornamented pitcher	44
25. A terra-cotta spherical vase	44
26. Gold mask, embossed ; found on the face of a corpse	44
27, 28, 29. Chased ornaments of gold plate, representing a leaf, a flower, and a butterfly	44
30-36. Other objects discovered at Mycenae. (After Schliemann.)	45
30, 31. Silver sceptres plated with gold, and provided with hilts of beautifully cut rock crystal	45
32. Gayly painted terra-cotta idol in form of a woman	45
33. Small bone with a fragment of a richly chased gold bracelet	45
34. Arrow heads of obsidian	45
35. Gold shoulder-strap	45
36. Silver cow's head with long gold horns, and disk on the forehead	45
37-40. Other objects discovered at Mycenae. (After Schliemann.)	46
37. Gold button with intaglio work, belonging probably to a scabbard	46

FIGURE	PAGE
38. Idol of Hera in form of a cow ; terra-cotta with bright red ornamentation	46
39. Two bronze swords with gold intagliated hilts; several gold buttons, two pieces of gold plate, and a ball of amber pierced, all probably belonging to the wooden scabbards	46
40. Front view of a double-bladed bronze axe. Chased gold ornaments	46
41. Ground-plan of the Treasury of Atreus. (After Gailhabaud.)	47
41a. Cross-section of Hill at Hissarlik. The Roman numerals indicate the different strata	50
41b. The great northeast tower, Sixth City, Troy. The stairs to the right date from the Eighth City, the wall at the extreme left from the Ninth City	53
41c. House wall, Sixth City, Troy	50
42. Youth accompanied by a pedagogue, from a vase	57
43. Battle of Hector and Achilles in the presence of Athena. Red-figured vase painting	58
44. Hermes and Achilles. (From a red-figured amphora.)	59
45. Molossian coin, with helmeted head of Pallas	60
46. Coin of Selymbria in Thrace, with head of Heracles in the lion's skin	60
47. The birth of Athena. Cameo	61
48. Two draped figures. From a red-figured vase	62
49. Odysseus and Philoctetes. Cameo (double original size)	62
50. Athenian coin	63
51. Coin of Orthia in Elis, with helmeted head of Pallas	63
52. From a representation of the Lower World. On a vase	64
53. Hector and Achilles at the Scaean gate, with Trojans standing near. From a red-figured cylix	66
54. Theseus and Helena. From a Lucanian amphora ; red figures on black ground	68
55. Colossal marble bust of the Zeus of Otricoli. Rome, Vatican. (From a photograph.)	69
56. Colossal marble bust of Hera. Rome, Villa Ludovisi. Perhaps from original of Alcamenes. (From photograph.)	69
57. Pallas Athena, found at Velletri. Paris, Louvre. (From a photograph.)	70
58. Artemis Agrotera. Paris, Louvre. (From a photograph.)	71
59. Ares. Rome, Villa Ludovisi. (From a photograph.)	72
60. Demeter of Cnidus. London, British Museum. (From a photograph.)	73
61. Hermes. Rome. (From a photograph.)	74
62. Posidon. Rome	75
63. Hephaestus. Rome	75
64. Bust of Dionysus. Rome, Capitol. (From a photograph.)	77
65. View of Olympia. (Restoration.)	87
66. The Cella of the Temple of Zeus at Olympia, with the colossal statue of Zeus by Phidias. (Restoration.)	89
67. Elean coin of Hadrian's time, with the image of the Olympian Zeus	90
68. Ephebus hurling javelin	91
69. Antique statue of a boxer with boxing-gloves. Dresden. (After Clarac.)	92
70. Antique statue of an athlete, the so-called Apoxyomenus. Rome. (After Clarac.)	92
71. Ephebus provided with dumb-bells for jumping	93
72. Antique marble statue of a discus-thrower. Rome, Vatican. (From a photograph.)	94
73. Antique marble statue: group of wrestlers, the so-called Pancratiasts. Florence. (From a photograph.)	95
74. Preparation for the chariot-races ; mural painting in an Etruscan sepulchre. (After Micali.)	96

FIGURE	PAGE
75. Horse-race; reaching the goal; the victor received by the judge. Vase-painting. (After Gerhard.)	97
76. Two Greek warriors in full armor	100
77. Coin of the Temple of Ephesus. (After Curtius.)	102
78, 79. Two flat-boats, each with one bank of oars; penteconter of Phoenician form, from a vase-painting; and a boat with beak, from a medal	106
80. Fragment of the representation of an Attic trireme on a bas-relief	107
81, 82. Archaic black-figured vase-painting in Royal Museum, Berlin. 1. The Recovery of Helen at the Capture of Troy. 2. Battle between Achilles and Memnon	126
83-90. Coins of Hellas and the Hellenic Colonies	132
91-99. Coins from the Flourishing Period of Greek Art	132, 133
100-105. Macedonian Coins	133
106-111. Coins of Sicily and Magna Graecia	133
112. Statue of Aristogiton, the Tyrannicide. (Naples.)	140
113. Statue of Harmodius, the Tyrannicide. (Naples.)	141
114. Slaying of Hipparchus by Harmodius and Aristogiton. From a contemporary Athenian vase-painting. (Würzburg.)	142
115. An Athenian funeral procession. Terra-cotta plaque, Paris	148
116-119. Reliefs from a triumphal monument at Xanthus. London, British Museum.	152, 153
120. Later Temple of Artemis at Ephesus. (After Curtius.)	155
121. Croesus on the funeral pile. Painting on an Athenian vase of about 490 B.C.	157
122. The so-called Nicopolis silver vase, with representations of Scythians. From a Scythian grave in Southern Russia. (St. Petersburg, Hermitage.)	160
123. The so-called Nicopolis silver vase, with representations of Scythians	161
124, 125. Representation of Scythians on the shoulder of the so-called silver vase of Nicopolis	162
126, 127. Representation of Scythians on a silver vase from an old Scythian grave in Southern Russia. (St. Petersburg, Hermitage.)	163
128. The Plain of Marathon. (From a drawing by H. Belle.)	177
129. The so-called "Marathonian Soldier," the work of Aristocles; monument to Aristion	179
130. Map of Thermopylae and vicinity	186
131. Map of Sicily	193
132, 133. Battle Scenes between Greeks and Persians. Fragments from the frieze of the Temple of Wingless Victory at Athens. (British Museum.)	200
134. Map of Athens	207
135. The Acropolis at Athens. (From a photograph.)	219
136. Sophocles. Ancient marble statue in the Lateran Museum, Rome. (From a photograph.)	228
137. Temple of Athena at Sunium. (From a photograph.)	229
138. So-called Temple of Theseus from the northwest side. (From a photograph.)	230
139. The posticum of the Parthenon	232
140, 141. Two groups of sculptures, from the Frieze of the Parthenon. (British Museum.)	233
142. The Propylaea, entrance to the Acropolis; view from the southeast side	234
143. The Propylaea and the Pinacotheca. (From a photograph.)	234
144. Interior view of the Propylaea. (From a photograph.)	235
145. Temple of Wingless Victory (Athena-Niké Apteros)	236
146. Southern Porch of the Erechtheum. The Porch of the Maidens (Caryatides)	236
147. The Erechtheum from the East. (From a photograph.)	237

FIGURE	PAGE
148. Elean Coin of Hadrian's time. Coin with the Head of Olympian Zeus	238
149. Ground plan of the Temple of Zeus at Olympia	239
150. Antique marble bust of Pericles. Traceable to an original by Cresilas. (British Museum.)	243
151. Herodotus. (After Visconti.)	256
152. Thucydides. (After Visconti.)	256
153. Aristophanes	258
154. Alcibiades. (After Visconti.)	269
155. Penteconter; from a vase-painting. (After Panofka.)	282
156. Construction of the helm. (After Graser.)	282
157. Trophy. Token of victory on a Boeotian coin	283
158. Theatre at Egesta in Sicily, with stone seats. (Restoration.)	289
159. Euripides. (After Visconti.)	290
160. Socrates. Herme in Naples. (From a photograph.)	294
161. Site of Ancient Sardis. (After E. Reclus.)	299
162. Grave-relief of Dexeleos, who fell in the Corinthian war	302
163. Greek Peltast. From a vase-painting. (After V. Stackelberg.)	304
164. Corona of the tomb erected by the state in memory of those who fell in the Corinthian War	307
165. Isocrates. (After Visconti.)	326
166. The Niké (Victory) of Paeonius; found in Olympia. (From a photograph.)	328
167. Hermes of Praxiteles; found in Olympia. (From a photograph.)	329
168-174. Greek Artillery	330
168. Catapult, side view	330
169. Catapult, rear view	330
170. Catapult, seen from above	330
171-173. Pipe of the catapult	330
174. Catapult, with single beam	330
175-179. Greek artillery	331
175. Ballista, side view	331
176. Ballista, rear view	331
177. Pipe and projector of the Ballista, seen from above	331
178, 179. Gastraphetes ('stomach-bow')	331
180. Statue of Artemisia, Queen of King Mausolus of Caria. From the Mausoleum at Halicarnassus. (British Museum.)	340
181. Demosthenes. Ancient marble bust. (Berlin.)	346
182. An Athenian general (Phocion?)	351
183. Antique marble statue of Aeschines, at Naples. (From a photograph.)	354
184. Aristotle. (After Visconti.)	360
185. Alexander the Great. Antique marble bust. London, British Museum.	363
186. Battle of Issus. On a mosaic from Pompeii. (Naples, Royal Museum.)	369
187. Marble seat of the high-priest in the theatre of Dionysus at Athens. London, British Museum. (From a photograph.)	383
188. Menander. (After Visconti.)	391
189, 190. Coins of Demetrius Poliorcetes. (After Friedländer and v. Sallet.)	391
191. Demetrius Poliorcetes. (After Visconti.)	392
192. Coin-portrait of Ptolemy I. (After Visconti.)	394
192. Coin of Agathocles, King of Syracuse; Head of Cora (Persephone). With a wreath of ears of corn	394
194, 195. Zeno. Epicurus. (After Visconti.)	400
196. Coin-portrait of Antiochus I. (After Friedländer and v. Sallet.)	402
197. Coin-portrait of Ptolemy III. (After Visconti.)	402

FIGURE	PAGE
198. Coin-portrait of Ptolemy IV. (After Visconti.)	402
199. Coin-portrait of Ptolemy II. (After Visconti.)	404
200. Coins of Pyrrhus	405
201. Coin-portrait of Philip V. of Macedonia. (After Friedländer and v. Sallet.) .	410
202. Plan of the Palace at Cnossus	412
203. Mycenaean houses represented on porcelain plaques, the palace, Cnossus . .	416
204. Tablet with linear script from the palace, Cnossus, perhaps referring to chariot and horse	417
205. Plan of the palace at Phaestus	419

LIST OF PLATES.

PLATE	PAGE
I. Weapons, ornaments, and household utensils excavated by Dr. Schliemann on the site of ancient Troy. (From the originals now in Berlin.)	37
II. The Lions' Gate, Mycenae. (From a photograph.)	40
III. Antique statue of Apollo; in the Belvedere of the Vatican, Rome. (From a photograph.)	69
IV. Antique statue of Aphrodite, found on the island of Melos. In the Louvre at Paris. (From a photograph.)	70
V. Athletic sports. Arranged from the fragments of two cylices by the vase-painter Duris. (In the Berlin Museum.)	90
VI. Greek artisans: cobblers and smiths. Painting on an Athenian vase	111
VII. Ruins of the temple of Apollo at Corinth. Acrocorinthus in the background. (From a photograph.)	118
VIII. An Athenian school. Painting on a cylix by Duris. (Royal Museum, Berlin.)	136
IX. Darius holding a council of war; painting on an antique vase from Canosa	173
X. Piraeus at the present time. (From a photograph.)	207
XI. The Acropolis of Athens: Restoration drawn by G. Rehlender	218
XII. The Acropolis at Athens: Restoration by G. Theuerkauf	218
XIII. General view of the monuments of the Acropolis of Athens. (From a photograph.)	228
XIV. The Parthenon, viewed from the roof of the Propylaea. (From a photograph.)	231
XV. The south side of the Parthenon. (From a photograph.)	231
XVI. The Cella of the Parthenon, with the colossal statue of Pallas Athena, by Phidias. (Restoration by G. Rehlender.)	232
XVII. Temple of Apollo at Phigalia: Mt. Ithome in the distance. (From a photograph.)	238
XVIII. Map of Hellas, with the Dependencies of Athens and Sparta	266
XIX. Western pediment of the Temple at Aegina	327
XX. Young warriors arming for battle with the assistance of their squires. Painting on an antique cylix	355
XXI. Theatre of Dionysus at Athens. (From a photograph.)	383
XXII. Pavement of second floor still in position, the palace, Cnossus	414
XXIII. Corridor of second floor, with staircase leading to a third story, the palace, Cnossus	414
XXIV. Wall painting of a girl, the palace, Cnossus	414
XXV. Large tablet with linear script, the palace, Cnossus	416
XXVI. Figures of divinities and votary found in position in a Mycenaean shrine in the palace, Cnossus	418
XXVII. Seats overlooking supposed agora, Phaestus	420
XXVIII. Stairs leading to upper story; at the left, seats facing agora; in the centre, altar; at the right, west corridor, the palace, Phaestus	420
XXIX. Interior corridor showing entrance to magazines, the palace, Phaestus	421
XXX. Upper part of steatite vase from Hagia Triada, near Phaestus	421

BOOK I.

FROM THE PELASGIC PERIOD TO
THE PERSIAN WARS.

PART I.

FROM THE EARLIEST PERIOD OF GREEK HISTORY TO THE FIRST OLYMPIAD.

(To 776 B.C.)

CHAPTER I.

LAND OF THE GREEKS.

IN our survey of the history of the Orient, our readers have already repeatedly met with the Greeks. With the dawn of the fifth century B.C. this highly gifted people began to force the Persians from their leading position in the political history of the ancient world; and the supremacy thus gained they maintained until the middle of the third century B.C., when the predominant influence in affairs passed over by gradual steps to Italy. The history of Greece was indeed by no means exclusively enacted within those boundaries of land and sea which men have been wont to call Greece. Nevertheless, the nature of the countries round about the Aegean Sea, in which, from the tenth century B.C. onward, we find the main branches of the Hellenic nation in permanent possession of the soil, has always exercised the greatest influence upon the social and political life, and upon the development of these dominant members of the Greek world. Therefore Greek history, as a part of universal history, properly begins with a consideration of the peculiar nature of the land of the Greeks.

It was mainly in their contact with the Orient, in its different stages, that the Greeks — except in Sicily and Lower Italy — attained their fullest national development. This connection with the east includes, first, the very imperfectly known period before the earliest conflicts with the Persians; then the so-called Classic, or Hellenic, age of Greek history down to the battle of Chaeronea; finally, the period of Macedonian supremacy — the Hellenistic age — down to the

complete development of the political system of the Epigoni, or successors of Alexander. Before the conflicts with Rome, inaugurated by King Pyrrhus of Epirus, the western side of the Greek peninsula was of little historical importance; and our interest centres mainly in those countries of the Greek world which border on the Aegean Sea. This sea, dotted with islands, and lying between the east coast of the Greek peninsula, the south coast of Macedonia and Thrace, and the western border of Asia Minor, and bounded on the south by the island chain of Cythera, Crete, Carpathus, and Rhodes, is from the earliest period the seat of Greek history. The Balkan range, with its western ramifications, marks on the large peninsula, now known as the Balkan peninsula, the line which the Greeks in ancient times crossed only sporadically. In Thrace it was only the series of flourishing cities west of Byzantium, on the Propontis, the Hellespont, and westward as far as the mouth and bay of the Strymon, that were of importance in Greek history. Macedonia, on the contrary, not only from its geographical character and its position between the Strymon and the Thessalian Olympus, but also on account of the mixture of old Greek and barbarian tribes in its population, forms the natural transition from the barbarians of the north to Greece proper; while its richly indented coast belonged, after the period of colonization in the seventh century B.C., for the most part directly to the Greek world.

The group of territorial divisions south of the 40° N. lat., which forms the smaller half of the great Balkan peninsula extending from Olympus to Taenarum, — its western shore washed by the Ionian Sea, and its eastern coast delicately and beautifully fretted by the inlets of the Aegean, — has ever been the chief theatre of Greek history. In contradistinction to the earliest colonial territory of the Greeks in Asia Minor, Lower Italy, and Sicily, we may call this network of cantons the home of the Greeks, or Central Greece. This portion of the Hellenic world is in its physical features very definitely characterized by an interesting parallelism of its parts, and by a most happy combination of sea and mountain. The maritime boundaries of northern Greece are marked on the east by the Gulf of Saloniki; on the west, less distinctly, by a deep indentation at the Epirot promontory of Acroceraunia. The Gulf of Ambracia, nearly coinciding with the 39° N. lat., forms the maritime boundary between northern and central Greece on the western side, as do the Gulf of Pagasae and the Malian Bay north and south of that parallel, on the east. And, again, the 38° N. lat. cuts the point where the waters of the eastern and western seas approach so close to

each other as to leave only a narrow isthmus to connect central Greece and the peninsula of the Peloponnese, — the Corinthian Gulf washing the southern shore of middle Greece and the northern coast of the Peloponnese, and the Saronic Gulf the west coast of Attica and the east shore of Argolis. But the mighty backbone of the cantons, from the 40th parallel to the Isthmus of Corinth, is formed by the continuation of that broad-based mountain range which, branching off from the Dinaric Alps, constitutes the western natural boundary of Macedonia. Starting from Lacmon in the north, and keeping much closer to the west coast of Greece than to the Aegean Sea, the long chain known as Pindus runs southward as far as the high pyramid of Tymphrestus. From this point the range continues its course southeastward under the name of Oeta. Some miles southward from Tymphrestus, on the other hand, the Corax range branches off, and runs directly southward to the Corinthian Gulf. This mountain wall divides the narrower western half of northern and central Greece from the much broader eastern half. From Oeta, again, branches off towards the southeast the long chain which forms the massive central ridge of the whole eastern part of central Greece; it bears in the different cantons different names, which are borrowed from its highest elevations. In the northwest, it is world-renowned as Parnassus, and rises to the height of over 8000 feet; in its middle course it is known as Helicon; farther to the southeast, covered with oak and pine forests, it is known to legend as well as to history as Cithaeron; finally in Attica, its highest point is called Parnes, and at Cape Sunium, in the extreme southern part of Attica, this range drops abruptly into the blue waves of the Aegean Sea.

Within this great compass lie the various provinces of northern and central Greece, the names of which we so often meet in history. The western portion, together with the group of the Ionian Islands, forms a natural whole, although a political connection of the provinces Epirus, Acarnania, and Aetolia was in fact permanently developed only in a very late period of antiquity, and under the Byzantines. The large river Achelous, which rises on the slopes of Lacmon in the north, connects in its long course northern and eastern Epirus with the provinces of Acarnania and Aetolia lying to right and left of its lower valley. The territory of the Ozolian Locrians forms the transition from southern Aetolia to the eastern part of central Greece.

Northern and central Greece are on the east side much more sharply separated from each other. From the mighty mountain chains which form, as has been said, the backbone of the mainland of Greece, several

spurs branch off, sharply defining on the one hand the northern boundary of central Greece, and on the other hand separating the cantons from one another. The Cambunian Mountains, running eastward from Lacmon, and terminating in Olympus (over 10,000 feet in height), separate Thessaly from Macedonia. The Othrys range runs from Tymphrestus to the Gulf of Pagasae, dividing Thessaly from the luxuriant valley of the Sperchius; the southern boundary of this valley is the long range of Oeta. The valley of the Sperchius forms the transition from Thessaly to central Greece. The entrance is at the point where Callidromus, a spur of Oeta, falls away in steep bluffs into the marshy strand of the Malian Gulf, leaving only the narrow pass of Thermopylae, famed in history. From this place Oeta continues its course under a different name, and with less elevation, east-southeast, parallel with the coast, until it again unites with the spurs of Helicon and Cithaeron, between which and the Attic mountain Parnes flows the Asopus. The interior districts of central Greece are watered by the river Cephissus, which, rising in Mount Oeta, empties into the fish-abounding lake of Copais, unlike the Thessalian Peneus, which makes its way to the sea between Olympus and Ossa. The source of the Cephissus is in the district of Doris. Phocis includes the middle course of the river and the southern declivities of Parnassus. The broad valley of Lake Copais, and the neighboring territories bordering on the Strait of Euboea and the Corinthian Gulf, were called Boeotia; and the narrow littoral district north of Phocis and Boeotia was the territory of the Epicnemidian and Opuntian Locrians. Southeastward from Boeotia, on the one side, lies the peninsula of Attica, with its fretted coast; on the other, Megaris extends south and southwest from Cithaeron, between the Saronic and Corinthian Gulfs, up to the Isthmus of Corinth, which leads us in a southwestern direction over to the Peloponnese.

The Peloponnese, in its relation to the mainland of Greece, is almost as an island. The central part, Arcadia, is a large mountain district. From Cyllene, rising in the northeast to the height of about 7700 feet, mighty mountain walls run westward and southward, which, together with lesser ranges on the southern and western sides, cut off this canton almost entirely from the coast districts. The high central range of Maenalus divides Arcadia from north to south into two unequal parts. The smaller eastern district is a great enclosed plateau. The larger western part, watered by the swift mountain streams Ladon and Alpheus, has its chief entrance on the western side; namely, the valley of the Alpheus, which conducts all the waters of western

Arcadia to the Ionian Sea. The gulfs that indent the shores of the coast districts that surround the central province of the Peloponnese give the peninsula the peculiar form which was compared by the ancients to the leaf of the plane-tree. As in the north the Corinthian and Saronic Gulfs separate the island of Pelops from central Greece, so in the west the Bay of Cyparissia, in the south the Messenian and Laconian Gulfs, and the Gulf of Argos, help to give this land its distinctive and beautiful form. The northern border of the peninsula was divided into the districts of Corinth, Sicyon, and Achaïa. West of Arcadia are the broad plains of Elis, and on the east is the much indented peninsula of Argolis. The southern part is quite peculiar in its conformation. From the eastern wall of Arcadia a long mountain range called Parnon runs southward to the stormy, wave-beaten Cape Malea. Parallel with this runs from the middle of southern Arcadia the most beautiful and majestic mountain range of Greece, Taÿgetus, which attains a height of 7800 feet. These mountains, and the intervening valley of the Eurotas, form the district of Laconia. The land west of Taÿgetus and southwest of Arcadia,—the valley of the Pamisus, the heights of Ithome, and the peninsula between the Ionian Sea and the Gulf of Messene,—was called by the ancients Messenia. It was the most charming region of Greece proper, and its mild climate nourished an almost tropical vegetation.

The numerous islands of the Aegean Sea, partly the natural complements of the coasts of Thrace and Asia Minor, and partly the continuations of the mountain ranges of Thessaly, Attica, Argolis, and Laconia, form geographically the transition to Asia Minor, and were important centres for the historic life of the Greeks. Apart from isolated small groups, the ancients divided them into the Cyclades,—the mass of islands scattered over the southern part of the Aegean Sea,—and those lying outside of this system, the so-called Sporades. Of the Cyclades, the island of greatest political importance down to the year 465 B.C. was Naxos, while the geographical centre was perhaps Delos. Among the Sporades, those which attained to the greatest historical significance were the long island Euboea, which stretches along the coast of Boeotia; in the north and northeast of the Aegean Sea, Thasos, Samothrace, Imbros, Lemnos; on the Asiatic coast, Lesbos, Chios, and Samos. This group terminates naturally in the south in the large island of Crete, which plays no great rôle in the history of ancient Greece; and in Rhodes, with its neighboring islands, whose most flourishing epoch belongs to the period after Alexander the Great.

Our geographical survey will close with a glance at the west coast of Asia Minor, where, from the time of the Dorian migration, the Greeks had a firm foothold. These shores, from the Bosphorus on the north to Cnidus on the south, were won over so early, so completely, and so permanently to Greek civilization that they can be viewed as an integral part of the Hellenic world. Geographically considered, Asiatic Greece is the broad strip of fertile land that extends along the eastern coast of the Aegean and the Propontis, from southwestern Caria to Chalcedon; it is bounded along its entire extent on the east by the western spurs of the Taurus, by the border ranges of Lydia and Phrygia, and by the Bithynian Olympus. Several transverse ridges run from the eastern mountains down to the water's edge. In the south, terminating in Mycale, is the range called Messogis, along the southern base of which flows the Maeander in countless windings. In Lydia are the chains of Tmolus and Sipylus, on the northern side of which lies the valley of the Hermus, and Temenus from whose northern slopes the Caicus springs. Finally in the north is the Trojan Ida. The sea has richly indented this coast; to favorable soil and climate is added here a rich abundance of harbors, inlets, and peninsulas. But here too, as in Europe, especially at the mouth of the Achelous and at Thermopylae, the alluvial deposits of the rivers and those of the tides have, in the course of centuries, filled up numerous bays, covered old harbors with mud, and joined little islands (as Lade, near Miletus) to the main land.

The physical features of the land of the Greeks were not without influence upon their character and their history. We note, first, that the form of this land, as a varied aggregate of high mountains and fertile plains, of enclosed basins and open river valleys, of islands of the most varied size, form, and physical resources, of level plateaux and richly indented coast-lines, must produce, even with an area of comparatively small extent, a far richer and more multiform historical life than the large but for the most part monotonous countries of the east. Not only the Hellenes, but even foreign peoples (the Turks only excepted), who during the Middle Ages temporarily ruled here, especially the knights from Southern Europe, have been strongly affected by the land in which their fortunes were thrown. We can recognize, as the dominating element in Greek life, a tenacious political particularism, very clearly stamped, though differently colored in different periods. The very shape of continental, peninsular, and maritime Greece was in the highest degree adapted to further the subdivision of the Greek people into numerous isolated and independent communities, each of

moderate size. Even in the earliest times we find a number of small tribes side by side. For several centuries the Greek world consists, in the main, of several hundreds of autonomous cities, standing independently side by side. Territorial conditions were such that the strongest obstacles always opposed the forcible union of the Greek cantons and cities, as far as the Greeks alone were concerned. There is here no long-extended river valley connecting the provinces even of the mainland of Greece, and making it possible to control them. There is no district which strategically dominates all the rest of the country. In the most flourishing period of Hellenic history, at the time of the victorious and united opposition to Persia, even the spirit of a political Panhellenism hardly outlived two decades. Ancient Greece never produced a great central city, such as, for instance, Memphis or Thebes in Egypt. The Greeks when left to themselves were never able to attain to more than a strongly-marked dualism. This characterizes their history as a nation very distinctly, especially from the age of Pericles to the overthrow of the Aetolian League.

The causes that led the Greek cities to group themselves into two great parties are very various, as the narrative of events will show. From the beginning there is an opposition between the Greeks of the interior and the Greeks of the coasts and islands. Essentially the same groups, after the Persian wars, stand opposed to each other as aristocratic and democratic states. The nature of their territory had from the beginning marked out for the Greeks the main lines of their social life. For centuries, among the oldest tribes in the cantons of the high mountains, shepherd life prevailed, while that of agriculture prevailed in the lowlands. It was a long time before the fishermen of the coasts and islands recognized the full significance of the wonderful littoral formation of Greece, and their own vocation as that of seamen; many years must pass before the nautical skill of the maritime Greeks was able to bear a comparison with the native abilities of the interior tribes, and many more years before the spirit of nautical enterprise became really characteristic of the Greeks.

The varied nature of the territory of the Greeks is matched by the richness and variety in the development of their political organisms and of their social life. Alongside of the half-primitive condition of the shepherd tribes of Epirus and the Klephts of Aetolia, and the brilliant chivalry of Thessaly and Boeotia, there flourished in the great cities of Asiatic Greece trade and industry, as well as the beginning of science, and the splendid creations of poetry. The activity of vine-growers, of

peasants, of the fishermen of the Cyclades, the life of the landed proprietor in Elis, the rough shepherd and peasant life in Arcadia, all offer the sharpest contrasts to the clang of arms on the parade-grounds of Laconia, to the busy trade of Corinth, and to the strong currents of public life in Athens, where one may witness, in happy and varied combination, a most vigorous activity alike in trade, commerce, art, and poetry. Finally, reference must be made to the fact that the territory of this people, who were to succeed the Persians in the direction of the world's history, cannot be compared, in point of extent, with the great empires of the east. The area of Greek territory between Olympus and Taenarum, even including Epirus and the adjacent islands, can be estimated at most at only about 25,811 square miles; of these about 8288 belong to the Peloponnese, and to Attica only about 840.

CHAPTER II.

PELASGIANS, ACHAEANS, AND HELLENES.

THE ideas of the Greeks as to their remotest past have been preserved to us not only in a rich abundance of myths and legends, but also in traditions which were for centuries transmitted from generation to generation by poetry alone. To the information extracted by patient study from these sources, modern science adds the helps furnished by the knowledge of the earliest history of other peoples, by philology, ethnography, and especially by the history of those peoples of the Orient who, long before the Greeks, had attained to a high degree of culture. The actual history of Greece, down to the beginning of the Olympiads, may be sketched in a few brief sentences. The Greek people belong to the great Indo-Germanic, or Aryan, family, and stand ethnographically closest to the old Italic branch, whose acquaintance we make at a later period on the peninsula of the Apennines. The earliest home of the original Greeks must, in all probability, be sought in the interior of Asia. Whether the different tribes, at the time of their migration into Greece, found already there an older population, which they expelled, destroyed, or subjugated, has not been determined with any degree of certainty. The route by which the original Greeks came from Asia into Greece is still a subject of dispute and doubt. It is most probable that there was a series of different migrations from the north. Whether, however, the whole mass of the peoples afterward known as Greeks made their way around the Black Sea to the Danube, and entered the Greek peninsula from that direction, or whether at least a part of the Greek tribes and of the peoples nearest akin to them wandered through Asia Minor, and, leaving behind a part of their members on the western border of Anatolia, crossed the straits on both sides of the Propontis, — these are questions as yet undetermined.

So much only is certain, that in the earliest period of Greek history we find established in the territory between eastern Macedonia and Taenarum, as well as in Euboea and the so-called Ionian islands, a large group of peoples, substantially alike, and subdivided into numerous

larger and smaller tribes. These we may call the original Greeks. In the historic period the ancient population was by the Greeks known as the Pelasgians. But it is in the highest degree doubtful whether the ancient Greeks called themselves so. That view seems most acceptable according to which Pelasgians signifies merely 'the ancients,' the name Pelasgians, as that of the earliest Greeks, not originating until the dominant civilized tribes had formed a closer union under the name of Hellenes. In short, it seems most probable that the terms Pelasgians, Achaeans and Hellenes apply not to distinct nationalities, but merely to different stages in the national development of the Greek people themselves. In accordance with this theory we shall describe the process of growth, from the conditions of the Pelasgic age, first to those of the Achaean civilization, then the further development of the noblest tribes into the ripe culture of the Hellenic age. Before so doing, however, we must briefly sum up the main features of the history of the Greeks in its earliest stage.

In the Pelasgic age we find the ancient Greeks in conditions that are, it is true, still primitive and rude, but yet, in spite of many savage traits, no longer really barbarous. So at the earliest period, in the mass of the ancient Greeks between the valley of the Axius and the high mountains of Laconia, we observe already well differentiated the tribes that have made the transition from the hunter's and shepherd's life to that of agriculture and of fixed habitations, and those that are still for the most part held to a pastoral life, and dwell principally in the higher mountains. The latter represent for a long time a half-nomadic, restless element among the Greeks. They are always quite ready, under the pressure of circumstances, to leave their homes, to conquer new ones, and to bring disquiet and insecurity even into regions already civilized. Such pressure came especially from the barbarian tribes of the north, who, during the dark ages of the Greek prehistoric period, were continually encroaching on the space over which the Pelasgic tribes had spread themselves. Their predatory incursions into Greek territory occur often during the later periods. In the islands of the Aegean Sea another, possibly Carian, population extended close up to the outskirts of the old Greek tribes.

The life of the Greek peasants and herdsmen was long patriarchal in its character. The ox and the horse were known, and drew the chariot as well as the plough. The chief riches consisted in great herds of swine, sheep, and cattle. Fishermen already navigated the waters of the innumerable inlets that indent the coast. The forms of political

life were altogether patriarchal. Everywhere were 'kings,' the ruling heads of the numerous small tribes. The chieftain was the head of the family from which the tribe traced its origin. The religion of these people seems to have been essentially a worship of the mighty forces of nature. Their gods, conceived even then doubtless as persons, were worshipped without temples or images, and were propitiated with prayers and with sacrifices. At the head

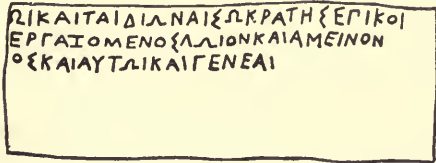

FIG. 1. — Ancient oracle-plaque of thin lead from Dodona (after Karapanos).

of the system was Zeus, the god of heaven; at his side Dione, the goddess of earth, who, however, was early supplanted by Hera, also conceived at first as a goddess of earth. Then came Demeter, 'mother earth,' the patron of agriculture and of civilized life; Hestia the protecting tutelary divinity of domestic and sacrificial fire; Hermes, the swift messenger of the gods, who drove the clouds and tended the herds; Poseidon, the god of the sea; and Aïdoneus, or Hades, god of

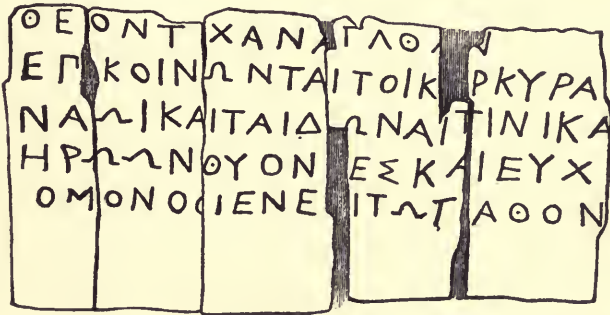

FIG. 2. — Ancient oracle-plaque of thin lead from Dodona (after Karapanos).

the nether world. The art of prophecy was developed early. The oldest oracle was at Dodona in Epirus, where priests interpreted the utterances of the supreme god as heard in the rustling of the leaves of the sacred oaks (Figs. 1, 2).¹

¹ Figs. 1 and 2 represent two inscriptions (from Dodona) of the historic period. The lead plaques on which they were scratched were offered to the priests of Zeus. The upper plaque (Fig. 1), the left side of which is broken off, reads: . . . *ω και τῆ Διῶνα Σωκράτης ἐπικοί | . . . ἐργαζόμενος λῶνον και ἄμεινον | . . . ος και αὐτῷ και γενεᾷ.* | 'A man named Socrates asks Zeus Naeus, and Dione, what he shall do in order that he and his race may have a better and happier lot.' The lower one (Fig. 2), which is broken on the right, reads: *Θεὸν τύχαν ἀγαθάν | Ἐπικουῶνται τοὶ Κορκύρα . . . | Νάω και τῆ Διῶνα, τίη*

We know nothing as to how long the Greeks continued in the quiet Pelasgian conditions. But the causes can perhaps be discerned, which, in a hundred different localities in Greece, led to internal commotion and powerful fermentation, out of which duly resulted the knightly Achaeans.

First in importance among these transforming influences were those that were exercised by the highly civilized countries of the east, influences that reached the Greeks mainly through the Phoenicians. These bold seamen, who, during the fourteenth century B.C., began the colonization of Cyprus, had, as early as the first half of the thirteenth century B.C., discovered the islands of the Aegean Sea, and had recognized their value for the trade and industry of their own rich and flourishing cities, among which Sidon then played the first rôle. In Crete they came in contact with a highly civilized people, once the rulers of the Aegean, but now in their decline, traditions of whom still remain in the stories of Minos and the Labyrinth. Here they apparently established colonies of their own. Soon a number of the islands of the Aegean Sea, such as Samothrace, Thasos, Thera, OIiarus, Melos, became, and for several generations continued to be, important stations for the Semitic tradesmen. From these posts they found their way to the Black Sea on the one side, and on the other to those parts of the coast of the mainland of Greece that were most suitable for their purposes. In their advance toward the mainland of Greece and the Peloponnese, the date of which must be reckoned about 1200 B.C., they first took possession of small islands near the coast, such as Minoa, near Megaris, and Cythera, south of Laconia, but they afterwards planted several notable stations on the continent. Attica shows, also, various distinct traces of very early contact with the Phoenicians. Thebes, or rather the citadel, the Cadmea, celebrated in Greek mythology in the legends of Cadmus, may have been one of the chief Phoenician colonies. The same is true of Acrocorinthus, possibly also of the coast districts of Elis. Greece was of the highest importance to the Phoenicians. Their merchants entered the Strait of Euboea, and the Gulfs of Pagasae, Argolis, and Laconia, finding among the Greeks a convenient market for the products of their own and of Babylonian industry, and receiving in exchange wool, hides, and slaves ;

κα . . . | ἡρώων θύοντες καὶ εὐχ . . . | ὁμονοῖεν ἐπὶ τῶγαθόν. | 'With God's help and good luck. The Corcyraeans ask Zeus Naeus, and Dione, to whom of the gods or demigods they are to sacrifice and pray, in order that they may come to an agreement with one another.'—(After Veredarius.)

sometimes, too, getting the last named by kidnapping. Besides, the newly discovered islands and coast-lands were rich in natural products, which they had the wisdom to appreciate and the skill to work up. The copper ores in Cyprus and Argolis, the gold-mines in Thasos and on the neighboring Thracian coast, important as they were, were surpassed in importance by the highly prized purple shellfish which abounded in the Thessalian waters, in the Strait of Euboea, and especially in the Gulfs of Argolis and Laconia. The juice of these muscles was extracted for use in dyeing, in well-fortified factories, first in Cythera, and then at other points on the coast of Greece.

For perhaps a century the Phoenicians exercised a powerful influence upon the littoral Greeks; and they left behind considerable traces in the traditions and mythology of the Greeks, as well as in other ways. Many figures of the Phoenician religion, such as Baal Melkarth, Moloch, the Cabiri, have influenced to a marked degree the mythology and legends, at times even the religion, of the Greeks. Not less plain is the derivation of Aphrodite, completely transformed and ennobled, it is true, by Greek idealism, from the sensual, cruelly lascivious Asherah-Astarte. The inhabitants of the eastern Peloponnese seem to have borrowed from the East, and probably through the Phoenicians, the metal-work designs common in their art. The superior civilization that characterized the Phoenicians who appeared among the Greeks, had a very direct effect upon the development of a people so highly gifted, and, at all times, so emulous of foreign excellence.

The example of the Sidonians in nautical matters, and in the building of fortifications, had a very lasting effect. In the matter of skill in building, mining and engineering, the teachers of the Greeks were the Phoenicians, from whom they received later, also, the art of writing and the Babylonian weights and measures. Even the handicraft and artistic skill of the Greeks found its first models in articles brought into the country by the Sidonians.

But in addition to these influences from the East, there were still others which developed, in particular, the military character of the Greeks. The very nature of the country caused the gradual growth of an opposition between different tribes, as did also the social distinction between the Greeks of the lowlands and those of the highlands. As a consequence, the sword supplants the plough, and wars arise. The first movements of the kind were doubtless plundering expeditions of the wild herdsmen-tribes of the highlands against the settled and comparatively wealthy peoples of the lowlands and of the coasts. Simi-

larly must there have been, eventually, feuds between the mountain tribes themselves, as well as between civilized communities. Naturally, also, long-continued contact with the Phoenicians could not fail to furnish sufficient occasion for crossing swords with the Semites. With the beginning, however, of this era of warfare, Greek history takes on a different aspect. New influences are at work, which, with increasing strength, duly impress and characterize public life. The immediate effect was the disappearance of the rustic and patriarchal element of the Pelasgic civilization in ancient Greece, amid the clangor of weapons and the shouts of warriors.

The necessity of repelling pirates and robbers by sea and land led to the building of fortified places. The lowlands of Greece were covered with numerous *Larissae* ('forts'). The people soon learned to fortify the high places, whither they were accustomed to flee on an invasion of the enemy, by a strong circular wall, built of immense rough and unhewn blocks of stone, laid one upon another, and held together by their own weight. Remains of such 'Cyclopean structures,' from very different periods of development, are still extant. Such a structure was the acropolis of Tiryns in Argolis, still in great measure preserved. Upon a hill which rises only fifty-feet above the plain, but whose length is nine hundred feet, and breadth three hundred, an enclosing wall, without towers, follows the brink of the cliff, showing no solid-stone masses, but traversed by interior galleries. With an apparent thickness of twenty-five feet, the real wall, as it is still seen to-day, must be reckoned at only fifteen feet. On each side of this solid central wall run covered ways, or galleries, five feet wide. In front of the outer wall of these galleries, which was pierced with apertures to give light, there was probably, in olden times, another outer line of defence. The largest stone blocks of the walls of Tiryns are from seven to ten feet long. These fortresses gradually improved as the skill of the builders increased, and finally developed into real citadels, mark the beginning of a very significant line of development. Gradually, even in the pre-Hellenic period, there grew up, at the foot of the acropolis, little municipal communities. But far into the Hellenic period, the acropolis, 'the upper city,' — which, in coast-towns, picturesquely overlooked for a great distance the harbors and roads, — maintained its greater importance. Here were collected the sacred treasures; here lived the king; here stood the senate-house, often, too, the residences of the nobility. With the castles, however, there grew up in the early Greek period a warlike aristocracy, the horsemen, or knights.

The storms of the new period transformed patriarchal chiefs into soldier-princes, who devoted themselves with whole soul to the profession of arms instead of agriculture, and, by reason of inherited or of newly acquired wealth, were able to follow their inclinations. Greek history shows us what an extraordinary part this new nobility, which gradually grew to great numerical strength, continued to play until the period of the Tyrants and of the establishment of the democratic forms of government.

These, then, are the factors which contributed most toward arousing the Greek people out of the simple conditions of Pelasgic life. Without doubt the quiet early period was followed by a wild, stormy age that abounded in cruel scenes, such as those upon which the sun of Homer shone.

This transition period the Greeks afterwards called the Heroic Age. The myths and traditions of this period, preserved by the Greek tribes and by their poets, are of varied character. On the one hand, there were repeatedly developed, from the local or honorary epithets of different deities, forms of demigods who performed mighty deeds on Greek soil; or the mythical history of a deity was simply transferred to a human being. On the other hand, this imaginative people was fond of combining their historical recollections, and heaping the deeds and experiences of whole tribes and epochs upon some heroic personality, the traditions connected with whom would in the course of development repeatedly change color and form through the admixture of new elements. The most colossal figure of this kind is of course Heracles (Fig. 3), the son of Zeus and Almena, who, through his mother and his human father, Amphitryon, was of the race of the Persidae, and belonged originally to the circle of Theban and Argive myths and traditions. But the circle of myths connected with him was gradually extended until he became a part of the mythology of almost all the Greek tribes, and was thus connected with nearly all the memorable deeds wrought by the Greek heroes in groups. Not only is Heracles reputed to have won a title to the possession of those Peloponnesian countries which later the Dorians conquered under the lead of the Heraclidae, but the identification of this hero as the so-called Tyrian Hercules with the Phoenician Baal Melkarth, added new and remarkable elements to his mythology. He wanders even as far as the shores of the ocean, and becomes thereby the mythical founder of the many Greek colonial cities which sprang up afterwards on the coasts of the western Mediterranean. But finally Greek reflection developed out of this Heracles, to whom gymnasia and palaestrae were consecrated, a

moral ideal, the personification of heroic strength which ascends to heaven by means of pain and toil, self-denial and self-conquest.

Greek heroic tradition is fond of uniting its most celebrated heroes



FIG. 3. — Colossal Statue of Heracles. Copied by Glycon after a work of Lysippus, representing the hero at a moment of rest. The hand resting on the back holds an apple of the Hesperides. Found in the Baths of Caracalla. Marble. Museum at Naples. (From photograph.)

in great common undertakings by land and sea. To the narratives of such enterprises, wonderfully constructed out of myth and tradition, an ever-growing mass of new legend became attached in the course of centuries, as knowledge of the territory increased on which the oldest fabulous history was enacted, and according as the epic, and subsequently the dramatic art of the Greeks made use of these subjects.



FIG. 4. — Typical wall of the Second City, Troy.



FIG. 5. — Walls of the Sixth City, Troy. In the foreground, to the right, part of a tower.



Weapons, ornaments, and household utensils excavated

I.



Created by Dr. Schliemann on the site of ancient Troy.
Originals now in Berlin.

Here belongs the so-called Argonautic Expedition, a myth representing a natural phenomenon, localized and transformed into a legend; then connected with the Phoenician cults of the Minyans of Iolcus on the Pagasæan Gulf in Thessaly, and with recollections of ancient sea-voyages of this tribe.

The legends of the war of the Seven against Thebes give a vivid picture of the ancient feuds between tribes already highly civilized. It is, however, in the transcendent poems of Homer (Fig. 6) that the mightiest achievement of the Heroic Age is brilliantly portrayed, — the ten years' war waged against the Teucrian Troy or Ilium, on the northwest coast of Asia Minor, by almost the whole of the generation of Achaean heroes that preceded the Dorian migration. But the researches of scholars and even the self-sacrificing energy of Schliemann, on the soil of ancient Troas, have not been able to give a final answer to the question as to the historical truth contained in this wonderful legend (Figs. 4, 5; see also PLATE I.).¹

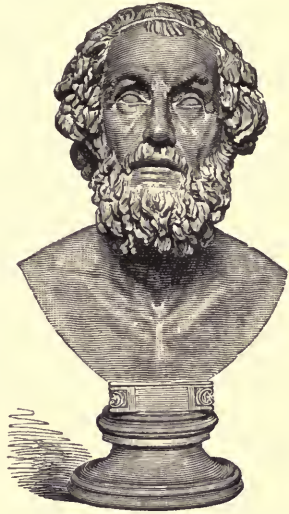

FIG. 6. — Ideal Marble Bust of Homer. Sansouci, Berlin. (From photograph.)

¹ EXPLANATION OF PLATE I.

Weapons, Jewelry, and Utensils found by Dr. Schliemann at Troy.

- | | |
|----------------------------------------------------|------------------------------------------|
| 1. Terra-cotta vase — owl's head. | 25. Amber cup. |
| 2. Bottle (terra-cotta). | 26. Silver vase. |
| 3. Gold cup (weight 600 grammes). | 27, 28. Bronze cup, and basin. |
| 4. Glazed terra-cotta vase. | 29. Grayish yellow pitcher (three feet). |
| 5. Cup. | 30. Clay cup. |
| 6. Basin. | 31. Spherical jug (three feet). |
| 7. Pudding-stone. | 32. Yellow pitcher. |
| 8. Vase (two feet). | 33. Drinking-cup. |
| 9. Spherical vessel (three feet). | 34. Clay ladle. |
| 10. Clay vase. | 35. Small vase, with breasts. |
| 11. Cup of peculiar shape. | 36. Rattle-box of terra-cotta. |
| 12. Fluted brown jug. | 37. Clay cup. |
| 13. Terra-cotta vase (three feet). | 38 to 41. Bronze knives. |
| 14. Shallow bowl. | 42, 43. Gold ear-rings. |
| 15. Polished dark-brown vase, shaped like a swine. | 44, 45. Gold bracelets. |
| 16. Owl-shaped vessel. | 46 to 49. Gold ear-rings. |
| 17. Large spherical jar. | 50. Gold brooch (for the hair). |
| 18. Jar. | 51. Gold diadem. |
| 19. Long-necked jug. | 52, 53. Gold ear-rings. |
| 20. Vase with owl's head and bowl. | 54 to 56. Bronze battle-axes. |
| 21. Three-footed ribbed vase. | 57. Lance-head welded to a battle-axe. |
| 22. Dark-red vase. | 58. Bronze lance-heads. |
| 23. Large red jar. | 59. Perforated axe (of green stone). |
| 24. Small ornamented vase. | 60. Small vase. |

Let us now briefly summarize what may be considered the historical results of the researches into the real condition of the Greeks at the close of the so-called Heroic Age. The first exhibition of power on the part of the Greeks, after they had outgrown Pelasgic conditions, consisted in shaking off the Phoenician yoke, and repelling direct Phoenician influence so far as the mainland and the Peloponnese are concerned. This movement seems to have been inaugurated vigorously and successfully about the year 1100 B.C. But Sidonian commerce still long dominated the Aegean Sea. Phoenician technical skill for a considerable time maintained its prestige, and the trade of the Sidonians with the Greeks remained active for yet many generations.

It is characteristic of the further development of the Greeks that gradually a number of single tribes became more prominent, and that in due time several organized communities showing marked individuality of character sprang up. Finally it may be believed that during the early, stormy decades of the Heroic Age there was no lack of migrations and of conquering chieftains in the Greek world. The pressure of the northern alien peoples doubtless drove new Greek tribes southward, while civil dissensions forced more than one tribe from its home, and bold heroes with their followers repeatedly invaded the territories of their weaker neighbors, and founded new dynasties.

This warlike, chivalrous nation of poetry and legend at the close of the pre-Hellenic period is wont to be called 'Achaean.' The name Achaean, which in the Hellenic epoch survived in a part of Thessaly, in the north of the Peloponnese, and in Italy, became a local name probably only in consequence of the revolutions occasioned by the Dorian migration. It may be maintained, then, that the name 'Achaeans' signifies the nobles, the worthy, and applies to the whole of the 'hero-nation,' especially to the Greek patrician families, who until the time of the Dorian migration are the chief actors in the history of Greece as it was developed from Pelasgic conditions.

Of the tribal and constitutional developments of this age some considerable remains survived into the Hellenic period. The Dorians are still an insignificant people, dwelling in the mountains on the northern edge of the beautiful basin which had not yet received the name of Thessaly. The Ionian race had spread over the northern coast of the Peloponnese (the old district of Aegialea), over a part of the east coast of the peninsula along the Saronic Gulf, and over Megaris and Attica. Among the Ionian districts Attica had already attained a certain prominence before the Dorian age. Here Theseus, or rather

a race of warlike chieftains who traced their descent from the Ionian ancestral hero, Theseus, had, after fierce conflicts, succeeded in uniting the four different divisions of this locality with the citadel Cecropia (later the Acropolis of Athens) and the plain of the Cephissus as the central point.

But the most conspicuous position in the pre-Doric period had been won by the patrician states in the Peloponnese. The little kingdom of the Nelidae, in the southwest corner of the peninsula, with Pylus as the capital, is renowned as the land of the wise Nestor. Still more important in the Achaean period was the power of the royal house of the Atridae, although horrible traditions cast upon its splendor a dark and bloody shadow. The southeastern side of the Peloponnese, which had from the earliest times been inhabited by a progressive people, had become also a centre of the warlike Achaean life. The most important district at this time is central Argolis, the land of the Danaï, with Mycenae as the capital of the Atridae. From this point the Danaï ruled a territory which extended over the district of Argolis, taken in its widest sense. Not only did the country as far as Corinth, Cleonae, and the valley of the Asopus, belong directly to Mycenae; but also the chieftains in Tiryns, Argos, and on the coast of the peninsula of Paros, were under the sovereignty of the king of Mycenae, while the rulers also of the valley of the Eurotas traced their descent from Atreus. As is well known, there remains to this day an imposing ruin, which furnishes the strongest proof of the power of the Atridae. The remains of the citadel at Mycenae, the great importance of which was not fully recognized until Schliemann's splendid excavations,¹ show in their different parts traces of a very remarkable development that may have been due to foreign influence, from masonry of the roughest Cyclopean kind up to the edifice artistically built out of hewn stones. Two and a half leagues north of Argos, in the inmost recess of the valley of the Inachus, rises the citadel hill. The Acropolis (Fig. 7), which has on its summit still another small ring-shaped enclosure, is surrounded by a massive circular wall of a very firm dark-colored conglomerate (*breccia*). The wall follows everywhere the edge of the cliff, showing in some parts roughly massed layers of stone, as at Tiryns, in others, again, polygonal blocks artificially joined together, then again, for considerable distances, horizontal layers of stone with rectangular edges. On the southwestern side is the chief

¹ Many of the smaller objects discovered by Dr. Schliemann at Mycenae are represented in Figs. 12-40 below (pp. 43-46).

entrance, — the celebrated Gate of Lions (PLATE II.). It takes its name from the oldest extant remains of sculpture in Greece. In the triangular opening in the wall, above the door, an immense bas-relief slab of grayish limestone was fitted, representing a section of a perpendicular column, which stands out from the slab in indistinct outlines, with a lioness on either side. In this acropolis Schliemann found graves with remains of human beings, with countless vessels of clay, alabaster, and gold, ornaments of rock crystal, of copper, silver, gold, and ivory. From the neighborhood of the Gate of Lions spring the walls that enclosed the lower town. The lower town lay



FIG. 7.—Ruins of the Acropolis of Mycenae. (After Gailhabaud.)

under the western declivity of the Acropolis, on the ridge which extends southward high above the plain and the modern Greek town, Charvati. In this lower town are several remarkable subterranean buildings, tombs and treasuries of the old princes of the land. The largest of these is the best preserved, namely, the remarkable round edifice which is known as the 'Treasury of Atreus' (or also as the 'Tomb of Agamemnon'), and is especially interesting on account of the 'Tholos,' the interior circular vault (Figs. 8-11, and 41). Such vaults and dome-shaped tombs, perhaps Phrygian in origin, supplanted the old conical-shaped mounds, and have recently been discovered in considerable numbers in different parts of Greece and in Crete.

A large part of the Greek world had now gradually come to enjoy

PLATE II.



The Lions' Gate, Mycenae.

(From a photograph.)

a considerable degree of civilization. Among the Greeks, it is true, as later among the Romans, even down to the period of their highest culture, usages of war prevailed, which denied every right to the conquered, assigned captured cities to the flames, delivered the person and family of the vanquished as booty to the victor. But the combat itself was already governed by certain recognized chivalric forms. Greek chieftains, who rode into battle commonly in chariots, who hurled the fearful javelin against the enemy, using less the sword, and still less

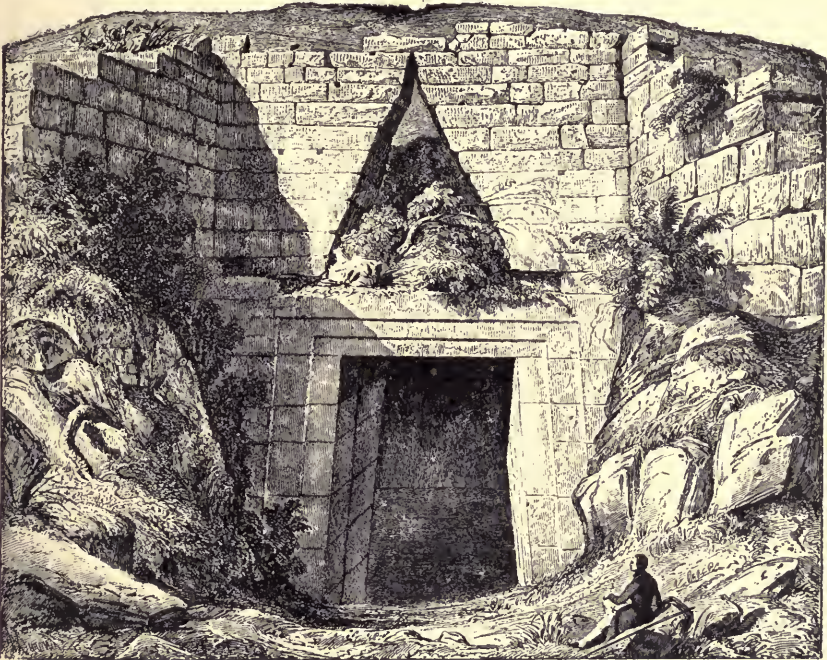

FIG. 8. — Entrance to the so-called Treasury of Atreus in Mycenae. (After Gailhabaud.)

the bow, preferred single combat with an antagonist of equal birth, and usually avoided striking down a common man. Of prime influence for all the future on the character of even the later Hellenic states, was the fact, that, in consequence of the ceaseless feuds, a class of slaves was developed, though it did not reach such dimensions as to have any important effect upon the political character of Greek life until after the Dorian migration. It is worthy of remark, on the contrary, that ancient rudeness and bloody savagery decline more and more. These break forth fearfully, it is true, at moments when hot Greek passion overthrows all barriers; but murder and even homicide, such as we find

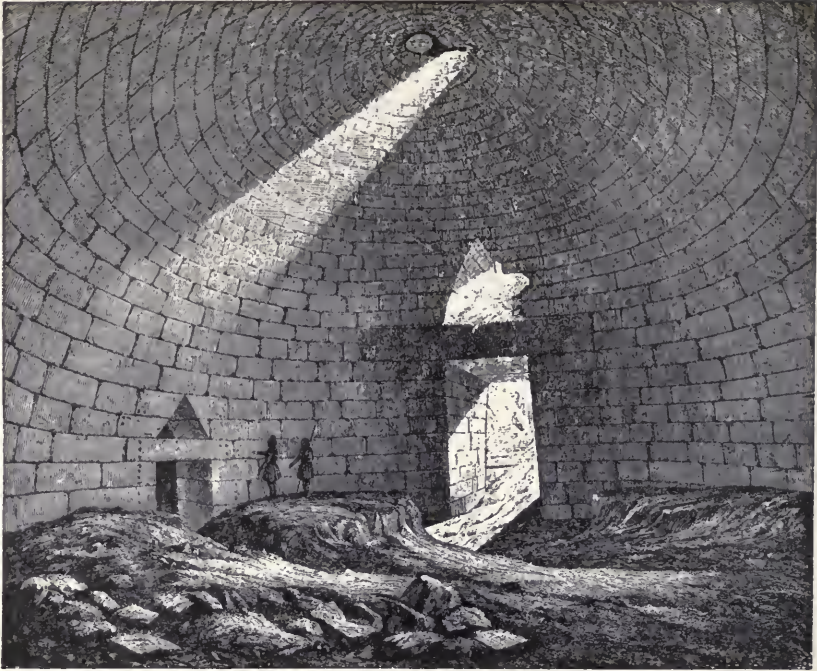

FIG. 9. — Interior view of the Treasury of Atreus in Mycenae. (After Gaillhabaud.)



FIGS. 10 and 11. — Section of the Treasury of Atreus (Tholos, and Tomb-chamber). (After Gaillhabaud.)



12.

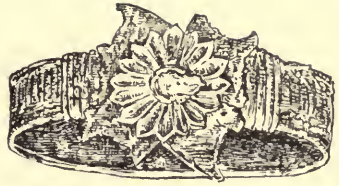

13.

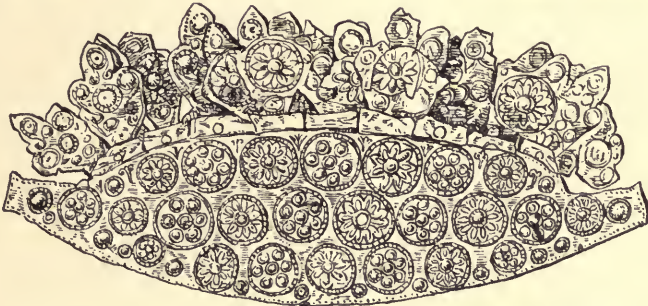

14.



15.



16.



17.



18.



19.



20.



21.

FIGS. 12-21. — Objects discovered at Mycenae. (After Schliemann.)

FIG. 12. — A wooden button plated with gold, intagliated and embossed. $\frac{1}{2}$ natural size.

FIG. 13. — Gold bracelet ornamented with a gold flower fastened by means of a large-headed silver pin to a silver plate, which is itself soldered on to the bracelet. $\frac{1}{2}$ natural size.

FIG. 14. — Elegant gold crown, covered with embossed ornaments and ornamented with 36 large golden leaves fastened on the headband. $\frac{1}{3}$ natural size.

FIGS. 15, 16, 17. — Gold ornaments chased, representing two swans, a hippocampus, and a butterfly. $\frac{1}{3}$ natural size.

FIG. 18. — Bronze sword. About $\frac{1}{3}$ natural size.

FIGS. 19, 20. — Spirals made of thick, four-sided gold wire. Natural size.

FIG. 21. — Vase of terra-cotta, ornamented with red and yellow stripes and black lines. $\frac{1}{2}$ natural size.



FIGS. 22-29. — Objects discovered at Mycenae. (After Schliemann.)

FIG. 22. — Silver pitcher, apparently without ornament. $\frac{1}{4}$ natural size.

FIG. 23. — Large, massive gold goblet with two handles, weighing 4 pounds. The bowl is ornamented with a row of 14 rosettes between an upper stripe of 3 lines and a lower one of 2 lines; the foot is ornamented with a row of half-spherical buttons. $\frac{1}{4}$ natural size.

FIG. 24. — Pitcher ornamented with three horizontal, parallel rows of spirals in chased work, so woven together as to form a pretty figure. $\frac{7}{10}$ natural size.

FIG. 25. — A terra-cotta spherical vase with flat base, ending above in a narrow closed neck, which is connected with the vase by two handles. The mouth of the vessel is like a chimney, and is very near the closed neck. About $\frac{3}{8}$ natural size.

FIG. 26. — Gold mask, embossed; found on the face of a corpse. About $\frac{1}{8}$ natural size.

FIGS. 27, 28, 29. — Chased ornaments of gold plate, representing a leaf, a flower, and a butterfly. $\frac{1}{2}$ natural size.

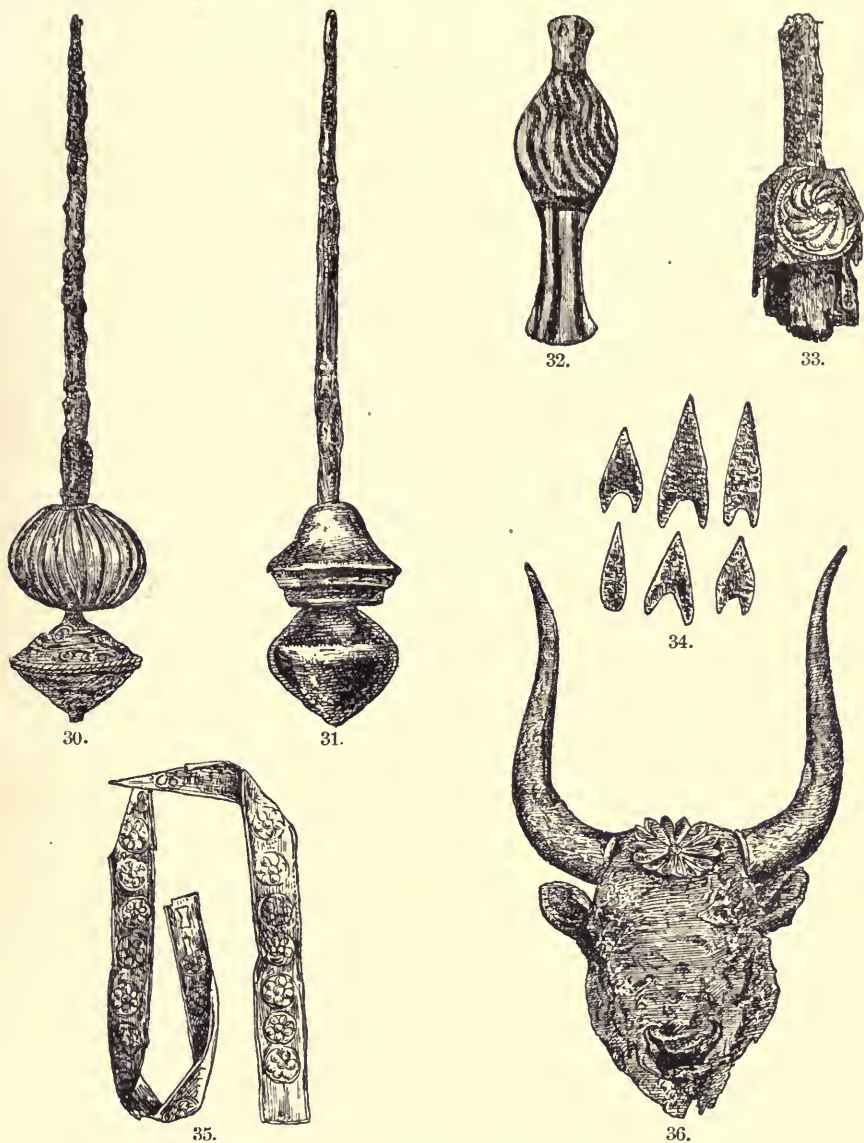

FIGS. 30-36. — Objects discovered at Mycenae. (After Schliemann.)

FIGS. 30, 31. — Silver sceptres plated with gold and provided with hilts of beautifully cut rock-crystal. The crystal ball on Fig. 30 is ornamented with small vertical furrows; the lower button is of gold with chased ornamentation. $\frac{1}{3}$ natural size.

FIG. 32. — Gayly painted terra-cotta idol in form of a woman. The upper body to the neck is a plain disk, with two elevations for the breasts; the lower part has the form of a gradually enlarging tube. $\frac{1}{2}$ natural size.

FIG. 33. — Small bone with a fragment of a richly chased gold bracelet. $\frac{3}{16}$ natural size.

FIG. 34. — Arrow heads of obsidian. $\frac{7}{16}$ natural size.

FIG. 35. — Gold belt or strap. $\frac{3}{32}$ natural size.

FIG. 36. — Silver cow's head with long gold horns, and a finely ornamented golden sun on the forehead. About $\frac{3}{70}$ natural size.



37.

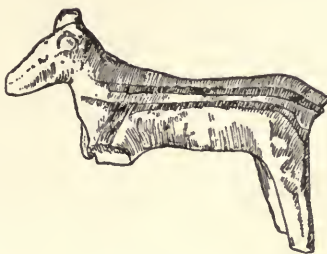

38.



39.



a.

40.



b.

FIGS. 37-40.— Objects discovered at Mycenae. (After Schliemann.)

FIG. 37.— Gold button with intaglio work, belonging probably to a scabbard. $\frac{1}{2}$ natural size.

FIG. 38.— Idol of Hera in form of a cow; terra-cotta with bright red ornamentation. $\frac{1}{2}$ natural size.

FIG. 39.— Two bronze swords with gold intagliated hilts, found near the body of a man, together with several gold buttons, two pieces of gold plate, and a ball of amber, pierced, all of which probably belonged to the wooden scabbards. $\frac{1}{2}$ natural size.

FIG. 40.— *a*, Front view of a double-bladed bronze axe. $\frac{1}{4}$ natural size.
b, Chased gold ornaments. $\frac{1}{4}$ natural size.

it marked with bloody traces in the older tradition, gradually cease to be common occurrences. Even revenge for bloodshed does not take such a horrible shape as among the Corsicans and Maniates in modern times. On the other hand, tradition shows traces of a beautiful idealism in morals and manners. The tenderest friendship, respect of youth for age, conjugal fidelity on the part of women, domestic feeling, the highest susceptibility to what is good and noble, shine out from the traditions of the Achaeans in a charming and touching manner. Thus had Greek life developed very varied forms, when the last wave of the ancient migrations, on breaking into the Hellenic peninsula from the north, once more caused universal confusion and tribal movements in all the region between Olympus and Malea, between the Ionian Sea and the coast-ranges of Asia Minor. When these had died out, Greece on both sides of the Aegean Sea took on the ethnographical features which it continued to maintain until the immigration of the Slavs and Bulgarians many centuries later.

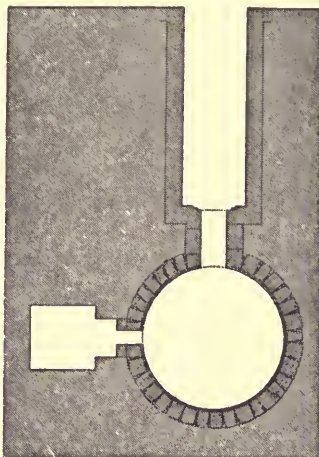

FIG. 41. — Ground plan of the Treasury of Atreus. (After Gailhabaud.)

Archaeological research within the last decade has made vast contributions to our knowledge of the early history of the civilization on the shores of the eastern Mediterranean. We may now lift the veil of history and peer beyond as far back as the second or third millennium B.C. Indeed, historians are enabled to establish several periods in the civilization of the peoples on and adjacent to the Aegean sea, anterior to the Trojan War.¹

Before the invaders of Aryan speech—the stock which ultimately became the Greeks (Hellenes)—had entered and taken possession of the Hellenic peninsula, we find this and the adjacent islands occupied by a white folk which apparently did not speak an Aryan tongue. The men of this race—whom some would identify with the Pelasgians—gave to many a hill and rock the name which was to abide with it forever. Corinth and

¹ The concluding paragraphs of this chapter are based on Professor J. B. Bury's recently issued 'History of Greece' (1900) and Dr. Dörpfeld's 'Troja und Ilion' (1902).

Tiryns, Parnassus and Olympus, Arne and Larissa, are names which the Greeks received from the people whom they dispossessed. This 'Aegean' race, as it has been called for want of a better name, had before the coming of the Greeks developed a civilization which we have only lately come to know. This civilization went hand in hand with an active trade both by land and by sea, which before the end of the third millennium B.C. had spread its influence far beyond the borders of the Aegean, as far at least as the Danube and the Nile, and it received in return gifts from all quarters of the world. Ivory came from the South, copper from the East, silver and tin from the far West, amber from the regions of the North. These peoples plied a busy trade by sea and their intercourse with the African continent can be traced back to even earlier times, since at the very beginning of Egyptian history we find in Egypt obsidian, which can only have come from the Aegean islands. The most notable remains of this Aegean civilization have been found in the earliest cities at Troy, in the little island of Amorgos, and in the great island of Crete.

At the time when the kings of the Twelfth Dynasty were reigning in Egypt (before 2500 B.C.), Crete was a land of flourishing communities, and was about to become, if it had not already become, a considerable sea-power. It formed the link between eastern Europe and the African continent, and into Crete from Libya came an influx of settlers who were soon amalgamated and became one race with the native Cretans. There was also an influx of peoples from the North, so that by the beginning of the second millennium Crete was already an island of mixed population. Phrygian and Libyan elements were blended with the original Cretan stock. Only in the eastern corner was there no mixture, and the pure-blooded natives of this region were distinguished in later times as 'True Cretans' (*Eteocretans*).

The Cretans held a distinct place in the history of civilization by inventing the first method of writing that was ever practised in Europe. We find indeed that two methods of writing were used in the island perhaps as far back as in the third millennium B.C. One of these was a system of picture writing, in which every word was represented by a hieroglyph, and this system appears to have been used by the original inhabitants. The other was in use throughout the whole island, and it was not entirely of native origin. It consisted of linear signs of which each probably denoted the syllable, and although some of these signs may have been indigenous, the system was certainly improved and supplemented by symbols borrowed from Libya and Egypt. The steps in the development of this writing and its possible influence upon the origin of the

Phoenician alphabet are at present imperfectly understood. It is clear, however, that the earliest Greek alphabet, which can hardly be older than about 900–800 B.C., is a modification of the Phoenician alphabet; but as further investigations are continued, it will probably be discovered that the Phoenician alphabet itself owes much to Cretan script.

In the middle of the second millennium B.C. we find the Aegean civilization in full bloom on the eastern side of the Peloponnesus. It is the civilization of the Bronze Age, the people having given up the old tools of stone. Its records are the monuments of stone which have remained for more than three thousand years above the face of the earth or have been brought to light by the spade, and the objects of daily use and luxury which were placed in the houses of the dead and have been unearthed chiefly in our days by the curiosity of Europeans seeking the origins of their own civilization. Since nowhere more abundant and significant records have been found than in the plain of southern Argos at Mycenae and Tiryns, and since the richest and strongest city on the coasts of the Aegean seems at this time to have been Mycenae, for want of a more exact term the whole civilization to which Mycenae's greatness belongs has been called the "Mycenaean," a not altogether happy term. The best evidence as to the date of this civilization is found in certain Mycenaean objects represented on Egyptian wall paintings of the fifteenth century B.C., as also in certain recently imported Egyptian objects of the same period discovered at Mycenae. Thus three pieces of porcelain, one inscribed with the name and two others with the cartouche of Amenhotep III. of Egypt (about 1400 B.C.) have been found in the chamber-tombs of Mycenae. Other confirmatory evidence is found in certain artistic motives in early Mycenaean art which must have been borrowed from Egypt before the tenth century.

In the third millennium B.C. a great city flourished near the southern shore of the Hellespont on the hill of Troy, now known as Hissarlik. It was reared upon the foundations of still earlier settlements dating back at least to the fourth millennium. The excavation of this hill, begun by Schliemann in 1870 and finished by Dörpfeld in 1894, has proved that city after city came into existence upon this site, flourished, and passed away. In fact, there seem to have been no less than thirteen successive settlements here; but as Dörpfeld's earlier reports spoke of only nine, that number is still retained in referring to them to avoid the confusion which would result from two sets of numbers.¹

¹ The most recently found settlements are the First Period of the First City; the Second and Third Periods of the Second City; and the First Period of the Seventh City.

In the troubled times at the dawn of history few towns could hope for a continuous existence for any great length of time, and thus at Troy the First City perished, and then the site lay waste a long time. At length the people of the Second City arrived, leveled off the remains of houses which they found still standing, and built their town. This in time grew to be a great city with powerful walls which were twice enlarged. Once it was burnt by the enemy, but it apparently recovered from this blow only to be burnt again, and utterly destroyed at a later time. Then the site again lay desolate, but in the course of time it came to be reoccupied, first by three little towns, one after the other, each meeting the fate of the more powerful city which had preceded it. But about the year 2000 the Sixth City was founded. This was the largest and strongest of the cities. It was the Homeric Troy. It, however, in its turn, met the fate of its predecessors. Mighty towers

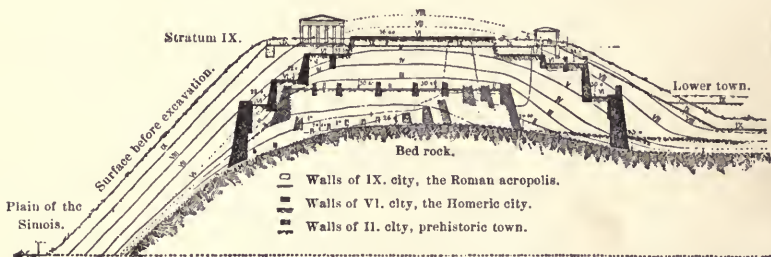

FIG. 41a. — Cross-section of hill at Hissarlik. The Roman numerals indicate the different strata.

and powerful walls could not keep out the enemy, and traces of fire everywhere among the ruins and the broken city walls are proofs of its violent end. In the course of time the hill was resettled. The people of the First Period of the Seventh City utilized the standing ruins in building their houses, tried to repair the town walls, and prospered for some time; but they at length fell a prey to a body of invaders of alien race, who in turn took possession of the site. This people had a different style of building and a different kind of pottery from the earlier inhabitants of Hissarlik. However, they did not live there long, but apparently deserted the place, which in historical times was occupied by a small town, the Ilium of the Greeks. The Ninth City was the Roman Ilium, a town which prospered greatly under the favor shown it by the Roman emperors, but gradually wasted away and disappeared.

Because of the successive settlements upon the hill at Hissarlik the



FIG. 41c. — House wall, Sixth City, Troy.

site is now a mass of ruins with walls running in every direction. The method by which the hill gradually rose may be seen in Fig. 41, *a*. The houses in all the cities were usually of sun-dried brick, which crumbled and melted away upon exposure to the elements. Then the new settlers would throw down any pieces of wall which they found standing and could not use in their own building, thus raising the surrounding level. The rubbish which gradually accumulated caused the ground to rise, so that, although the original hill could have been only about 115 feet above the sea, it was 162 feet high when Schliemann began his excavations.

Of the nine settlements, the second and sixth are the most interesting. Both were well fortified with walls of stone surmounted with other walls of sun-dried brick. In the Second City the lower wall was made of small, roughly worked stones laid in mud mortar. A typical piece of it is shown in Fig. 4. More than three hundred yards of this wall are still standing, in some places to a height of twenty-five feet. Schliemann's great treasure, part of which is shown in PLATE I., was found in a piece of this wall on the south side of the city, where it had evidently been deposited in a treasure-chamber hidden in the wall. The strong fortifications, the treasure, and the remains of a palace of sun-dried brick led Schliemann to believe that this Second City was the Troy of the Homeric period. But scholars soon began to doubt the correctness of this view. The Second City—that is, the citadel—was only about two acres in extent; the gold work found in it did not represent so high a civilization as that of Tiryns and Mycenae; and, above all, there were no remains of Mycenaean pottery. This last point is important, because in all parts of Greece and on the islands of the Mediterranean, wherever there are remains of the Mycenaean period, there are sure to be found fragments of what is called Mycenaean pottery. The local Trojan vases were of a monochrome ware, black or red with incised designs filled in with chalk, very different from the yellow vases with painted designs from Mycenae. These were the reasons which led to more extensive excavations, and brought about the discovery of the Sixth City.

There can be no question that the sixth settlement from the bottom was the town about which the story of the Trojan war was told. It had strong walls defended with towers, well fortified gates, palaces of stone, and in every way was more powerful and stronger than the Second City. Its town walls, still standing for more than three hundred and fifty yards and in places to a height of twenty feet, were

built in the shape of a polygon with one wall curiously projected beyond the other at the point where two sides intersected (Fig. 5). The wall was better built than that of the Second City, and the towers (Fig. 41, *b*) as well constructed as any Mycenaean wall in Greece. Both wall and towers originally had a superstructure of sun-dried brick to add to their height and strength. The palace which once stood in the middle of the town had been destroyed, but there were remains of several houses of stone. One house has a wall so well built (Fig. 41, *c*) that it would do credit to any age. This use of stone in private buildings distinguished this from the Second City, in which the houses were invariably of sun-dried brick. Fragments of Mycenaean pottery found among the ruins proved that this city was contemporary with Tiryns and Mycenae, and that it had commercial intercourse with them. Who its inhabitants were is not definitely known. It is not unlikely that they were Phrygians, but more than that we cannot say. The marks of fire throughout the ruins, and the wanton destruction of parts of the walls, leave no room for doubt as to how this city met its end.

Whereas until the year 1900 A.D. the sites of Troy and Mycenae had been regarded as the chief and most interesting centres of this earliest Aegean and Mycenaean civilization, in this year discoveries were made at Cnossus in Crete by Mr. A. J. Evans which demonstrated most conclusively the equal if not the greater importance of Crete in these early centuries. A great palace was uncovered, in which on every side were found evidences of the high state of development of its ancient inhabitants. The work of discovery is still in progress, both at Cnossus and elsewhere in Crete, but the objects already brought to light give us an entirely new idea of the civilization of the inhabitants of the island in Mycenaean times. An account of the more important discoveries at Cnossus and Phaestus will be found in the Appendix to this volume.

There are many problems connected with the ethnographical relations of the earliest inhabitants of the Aegean coasts and with the place of the primitive Greeks among them, that have not yet been solved. It is, however, reasonable to believe that further research will solve some of these. According to our present lights, it would appear that the Greeks were an invading people of Aryan speech who, first entering the Hellenic peninsula from the northwest, not far from about 3000–2500 B.C., gradually spread over it, partially conquering the primeval inhabitants, partially amalgamating themselves with them, the newcomers ultimately giving their language to the whole peninsula. History has left no clear record of the several stages of this process of occupation and possession. The Dorian invasion, which

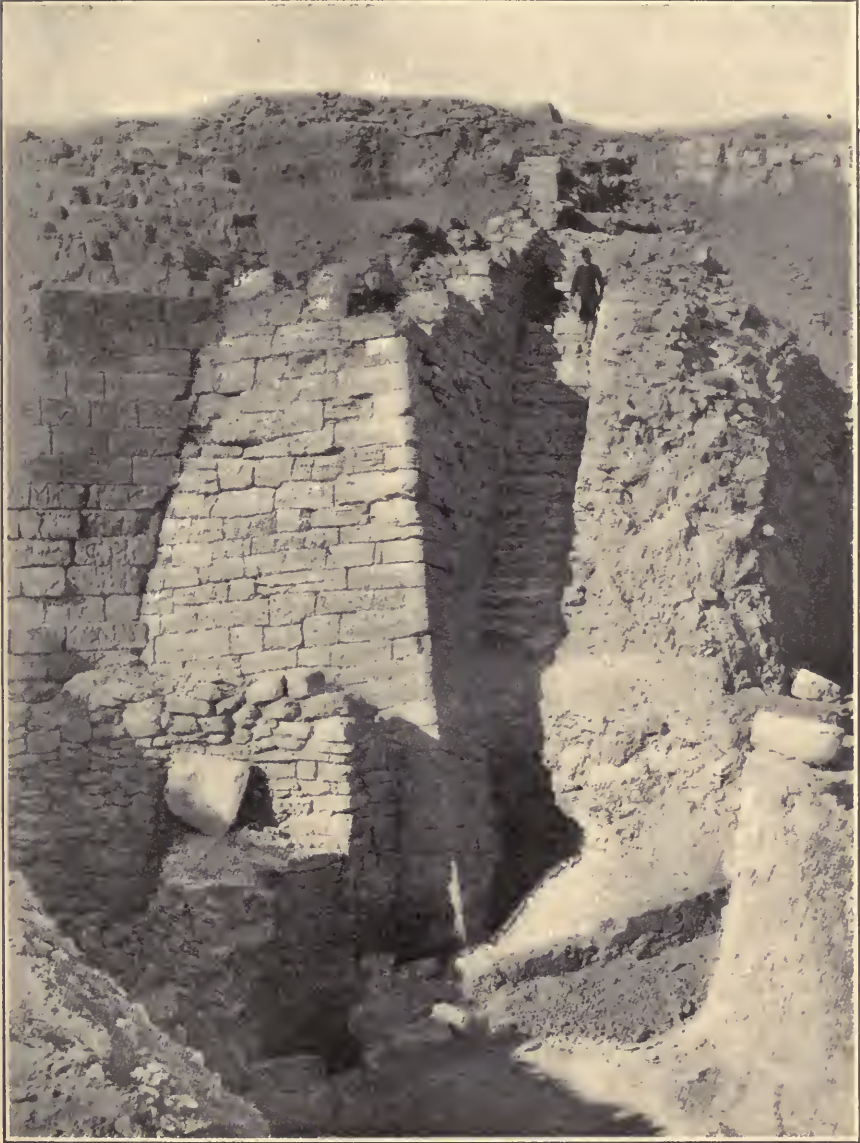

FIG. 41*b*. — The great northeast tower, Sixth City, Troy. The stairs to the right date from the Eighth City; the wall at the extreme left from the Ninth City.

must have taken place not far from 1200–1000 B.C., is perhaps the last great wave, but long before the Dorian invasion had taken place various tribes of Greek speech had permeated the Peloponnese and were already in occupation of central and northern Greece. “All this was a long and gradual process. It needed many centuries for the Greeks to blend with the older inhabitants and hellenize the countries in which they had settled. In eastern Greece where the Aegean or Mycenaean civilization flourished, the influence was reciprocal. Though the Greeks gradually imposed their language on the native races, they learned from a civilization which was more advanced than their own. Things shaped themselves differently in different places according to the number of the Greek settlers and the power and culture of the native people. In some countries, as seemingly in Attica, a small number of Greek strangers leavened the whole population, and spread the Greek tongue. Thus Attica became Greek, but the greater part of its inhabitants were sprung, not from Greeks, but from the old people who lived there before the Greeks came. In other countries the invaders came in larger numbers and the inhabitants were forced to make way for them. In Thessaly it would seem that the Greeks drove the Pelasgians back into one region of the country and spread over the rest themselves. We may say, at all events, that there was a time for most lands in Greece, when the Greek strangers and the native people lived side by side, speaking each their own native tongue and exercising a mutual influence which was to end in the fusion of blood out of which the Greeks of history sprang.”

“No reasonable system of chronology can avoid the conclusion that Greeks had already settled in the area of Aegean civilization when the Aegean civilization of the Bronze Age was at its height. Coming as they came, they necessarily fell under its influence in a way which could not have been the case if they had swept down in mighty hordes, conquered the land by a few swoops, and destroyed or enslaved its peoples. It is another question how far the process of assimilation had already advanced when the lords of Mycenae and Orchomenus and the other royal strongholds built their hill-tombs, and it is yet another whether any of these lords belonged to the race of the Greek strangers. To these questions we can give no positive answers; but this much we know: in the twelfth century, if not sooner, the Greeks began to expand in a new direction, eastward beyond the sea; and they bore with them to the coast of Asia the Aegean civilization. That civilization represents the environment of the heroic age of Greece.

“There can be little doubt that the mixture of the Greeks with the

native peoples had a decisive effect upon the differentiation of the Greek dialects. The dialects spoken by the first settlers in Thessaly, in Attica, in Arcadia, have some common characteristics, which tempt us to mark them as a group, and distinguish them from another set of dialects spoken by Greek folk which were to appear somewhat later on the stage of history. We may conjecture that the first set of invaders spoke in their old home much the same idiom; that this was differently modified in Thessaly and Boeotia, in Attica and Argolis, and the various countries where they settled; and that many of the local peculiarities were developed in the mouths of the conquered learning the tongue of the conquerors."

It is more than probable that the decipherment of the Cretan inscriptions, which will probably be effected in a few years, will solve many of the problems, both ethnographic and linguistic, which have long baffled the world of scholars.

CHAPTER III.

THE THESSALO-DORIAN MIGRATION AND ITS RESULTS.¹

TRADITION has always been consistent in ascribing the complete change in the map of Greece at the end of the Achaean period, and the origin of the distribution of tribes, with which the history of the Hellenic age begins, to a final great migration of northern Greek tribes, which began, according to the common chronology, 1133 or 1124 B.C.; i.e., not quite three generations after the so-called Siege of Troy.

Recent chronological investigations, however, have made it probable that, taken in connection with the date of the Graeco-Phoenician relations, as already indicated, this last great ethnographic disturbance on Greek soil began a hundred years later; that is, not till the last decades of the eleventh century B.C.

The several steps in these changes seem to have been about as follows. The Thessalians, a considerable branch of the Thresprotians of Epirus, yielding to the pressure of the Illyrians (according to the common chronology, in 1133 or 1124 B.C.), crossed over the Pindus into the valley of the Peneus, and gave their name to the country thus occupied. The duty of maintaining Greek civilization in Epirus thus devolved from this time on the brave Molossians; while the Thessalians poured down the eastern slopes of Pindus upon the Greeks of the lowlands, and shattered their political organisms. Two results ensued. The most vigorous and venturesome elements of the old inhabitants, so far as they had not fallen in battle, determined to emigrate, and, sword in hand, to establish new homes for themselves. The Lapithae and Minyans of Iolcus were scattered into different parts of Greece; but the strong Arnaeans turned *en masse* toward central Greece, crushed the ancient states of Thebes and Orchomenus in the Copais basin, and united under their rule the whole region, which now began its histori-

¹ For convenience, there are inserted in this chapter several cuts (Figs. 42-54) that are designed primarily to illustrate Greek costume. The originals belong to the classical period (*circa* 480-300), and the cuts must not be supposed to indicate the dress of the Greeks in the earlier period. They are briefly explained in the footnote on p. 60.

cal career under the name of Boeotia. In Thessaly the new masters of the country reduced to the condition of serfs those classes of the ancient inhabitants that had yielded to them and remained in the country. While the Arnaeans were occupied in completing their conquests in Boeotia, the Thessalians, in subduing the warlike tribes of the highlands surrounding the valley of the Peneus, one of these mountain peoples carried forward in a new and peculiar manner the mighty movement, whose influence had already extended as far as Cithaeron, until it reached the southernmost part of the Peloponnese.

These were the Dorians, a tribe hitherto rarely mentioned, who had dwelt mainly upon the southern slope of Olympus. These Dorians of



FIG. 42. — Youth accompanied by a pedagogue. From a vase. ($\frac{1}{2}$ original size.) (For a detailed explanation of Figs. 42-54, see the footnote on p. 60.)

Olympus, giving way before the Thessalian migration, cut their way southwards to the heights of Oeta, and occupied the territory about the sources of the Cephissus, between Oeta and Parnassus, ejecting the Dryopes, who then withdrew to the southernmost part of Argolis. The little district which now received the name Doris, covering an area of little more than eighty-four square miles, could not long satisfy the newly awakened spirit of conquest of a numerous people. According to the common tradition it was just twenty years (1104 B.C.) after the irruption of the Thessalians that the main body of the Dorians, under the lead of men who called themselves Heraclidae, 'descendants of Hercules,' began their march toward the Corinthian Gulf. Re-enforced by

bands of Aetolians under Oxylus, they crossed the narrow strait of Rhium, and began the conquest of the Peloponnese.

The Ionians of the northern coast of the Peloponnese, and the rude peoples of Arcadia, protected as they were by high mountain walls, had for the present no attraction for the conquerors. The Aetolians, however, easily subdued the level country of the Epeans, and established a new dominion with the citadel of Elis, situated on an eminence above the Peloponnesian Peneus, as capital. The Dorians, on the contrary, seem to have advanced through southern Arcadia, and to have followed the valley of the Alpheus to its headwaters. But here they divided. One part, under the Heraclide Cresphontes, fell upon the valley of the Pa-



FIG. 43. —Battle of Hector and Achilles in the presence of Athena. Red-figured vase painting. ($\frac{2}{3}$ original size.)

misus in Messenia, and established a new sovereignty with Stenyclarus as capital, and crushed the old kingdom of the Nelidae of Pylus, the noble families of which fled to Athens. The rest of the Dorians, who invaded the principal Achaean provinces in the east and southeast of the Peloponnese, made much slower progress. The Dorians were at this time only a rude mountain people. In open combat, it is true, the cavalry of the Achaeans was no match for the compact assaulting columns of Dorian infantry, armed with long spears; but the colossal walls of the Achaean castles and cities were proof against them. This difficulty forced the Dorians to establish, in the neighborhood of the chief Achaean towns, forts, or at least camps, whence they maintained an untiring watch and blockade against their adversaries, until the lat-

ter were finally either taken by surprise, or forced by exhaustion to come to terms. From such a camp, built by the Dorians on the Eurotas against Amyclae, sprang their chief city, Sparta. The obstinate and persistent resistance which the Achaeans of Laconia, supported by Amyclae, made to the conquerors, postponed for several generations the permanent establishment of a new Dorian state in this province. Here, too, probably lies the cause why a large body of Dorians soon turned away from the valley of the Eurotas, and marched eastward across Parnon toward the Gulf of Argolis. Led by the Heraclidae, they set sail, and got possession of the coast near Argos, founded the citadel Temenium, and finally forced Argos itself to capitulate. This ancient



FIG. 44. — Hermes and Achilles. From a red-figured amphora. ($\frac{1}{3}$ original size.)

city now became the new centre of the Dorian sovereignty for the whole of the eastern Peloponnese. From this base of operations Phlius, and the Ionian towns of Sicyon, Troezen, Epidaurus, and finally even Corinth, were conquered, and Doricized. Here the results of the conquest were in many respects different from those which obtained elsewhere in Greece. While the people of the plains and of the smaller towns were enslaved, the old Achaean citadel-towns, like Tiryns and Mycenae, maintained their existence, simply becoming subject to the Dorian Argos. In the Doricized towns of these regions of the Peloponnese a portion of the old ruling class was even admitted to citizenship in the new commonwealth.

From now onward the tribal movements in Greece become of signal

importance, their results penetrating to the remotest parts of the world. Doubtless even before this time numerous fragments of old, scattered Greek tribes of northern and central Greece had joined the conquering Dorians. But it was not till the old Achaean and Ionic states of the Peloponnese had felt the shock of a convulsion, which became more powerful from decade to decade, that the masses which had been driven out of their own homes began to stream into other regions not hitherto affected by the great upheaval.

Ancient tradition distinguishes three directions taken by the tribes in their migration. From the beginning Attica, which at the end of the Achaean period seemed to have the most stable organization, was a favorite place of refuge for fugitive Greeks of different tribes. The occupation of the Peneus basin by the Thessalians, of the Copais valley by the Arnaeans, the overthrow of the kingdom of Pylus by the Messenian Dorians, the occupation of the Ionian coast by the Dorians of Argos, caused multitudes to emigrate to Attica. To these were soon



FIG. 45. — Molossian coin, with helmeted head of Pallas.



FIG. 46. — Coin of Selymbria in Thrace, with head of Heracles in the lion's skin.

added other Ionians. A considerable part of the old Achaean stock in the Peloponnese, despairing of being able to resist the advance of the Dorians, left their homes and fell upon the Ionian northern coast of the Peloponnese, which was now abandoned by a large part of the Ionic population, and gradually changed into a new Achaia.

The accession of so many fugitives very materially strengthened Attica. Tradition traces back to these immigrants the successful resistance which Attica was able to make when the hordes of the conquerors finally reached her borders. This part of central Greece was twice very seriously threatened; first, by the Boeotians, whose king, Xanthus, was conquered in single combat by the brave Nelide, Melanthus, a fugitive from Pylus. This Melanthus was now made prince by the Attic nobility, instead of the Theside Thymotas, who was recognized as unequal to the demands of so troublous a time. His son and successor, Codrus, however, by a voluntary death (according to the common chronology 1066 B.C., but probably rather about 1046 B.C.), preserved Attica from falling into the hands of the Dorians, who had

crossed over the isthmus from Corinth, and had already wrested Megaris from the Ionians.

Attica had thus escaped the danger of being overrun by the Boeotians and Dorians. But the small, and on the whole not very fertile, district was not capable of supporting the multitude of refugees as permanent settlers. Doubtless very many foreign families of the Ionians, Lapithæ, and Pylians were at that time adopted into those of Attica; but the most of the fugitives moved gradually on. The new settlements of Thessalian and Boeotian fugitives in Chalcidice, Lemnos, Imbros, Samothrace, and elsewhere almost all remained historically unimportant; so much the more important, however, was the Ionian



FIG. 47. — The birth of Athena. The goddess springs full-armed from the head of Zeus. Eileithyia receives her, while a sister goddess supports the body of Zeus. Hephaestus in a short chiton stands by, holding the hammer with which he has opened the head for the birth. Cameo (double original size).

tide that flowed into the islands of the Aegean Sea and across into Asia Minor.

According to tradition, a considerable part of the Peloponnesian Achaeans, who had been driven from their settlements, had already found their way to these coasts, on which a new Asiatic Greece was to flourish. This Achaean (or Aeolic) migration, led by Pelopidae, reputed descendants of Agamemnon, started from the Peloponnese, and turned toward the islands and coasts of the northwestern part of Asia Minor. Ancient chronology puts the beginning of this movement at 1054 B.C., but later reckoning not till the middle of the tenth century. The Ionian migration, which, starting from Athens, occupied the islands between Attica and the shores of Lydia, then the coasts of Lydia and northwestern Caria, is said to have begun under princes of the house of Codrus, 1044 B.C. But this migration also belongs rather

to the time after the middle of the tenth century B.C. It is highly probable that the Achaean, as well as the Ionian, colonization of the east took place through several different expeditions.

The Achaean emigrants, consisting mainly of Greeks from Argolis and Laconia, got possession first of a little island near Lesbos, then of Lesbos itself, where they founded the city of Mytilene, and of Tenedos. It was not till much later that they settled also the coast of Mysia.

The natural course of the Ionic migration was the gradual occupation, first of the islands between Attica and Amorgos, then of the large Asiatic islands of Chios and Samos, and finally of the coast of Asia opposite. Some of the expeditions of the Ionians set out directly from

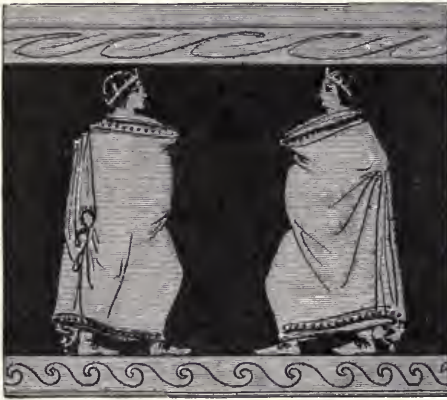

FIG. 48. — Two draped figures. From a red-figured vase.



FIG. 49. — Odysseus and Philoctetes. Cameo (double original size).

their old abodes, such as Phlius and Epidaurus; but the most important colonies, the settlements on the Cyclades, as well as Miletus and Ephesus, are traced to the Ionians from Attica. The Magnetes from Thessaly were so bold as to plant their cities far in the interior of Lydia and Caria, on the Hermus and the Meander.

The Ionian conquerors partly expelled, partly conquered and enslaved, the Carian aborigines on the Aegean islands. On the Asiatic mainland they had to maintain a continual struggle with the Lydian and Carian inhabitants. Here, too, the conquered Carians in the territories of the new cities were reduced to bondage. As their power steadily grew, the Ionians were able to Hellenize completely a broad strip of coast, and to advance considerably their eastern boundaries, especially along the river valleys. Besides the islands, the cities of Mi-

letus, Myus, Priene, Ephesus, Colophon, Lebedos, Teos, Erythrae, Clazomenae, and Phocaea on the coast of Asia Minor, came to be of especial importance.

Of the Dorians, the first to emigrate to Asia Minor were the conquerors of the eastern part of the Peloponnese, where a sort of adjustment had been made between them and the original Ionian and Achaean inhabitants. The island of Cythera was won by Dorians, who started from the east coast of Laconia, and Aegina by others, who started from Epidaurus, but on the expeditions to the east the Dorians were often joined by emigrants of the old races. In this way the Phoenician island of Thera was occupied by Minyans, Achaeans, and Dorians. The island of Melos was peopled afresh by Dorians, Minyans, and Laconian Achaeans; and some of these even reached the large and fertile island of Crete, and settled at Gortyna. About this time, too, Dorians began to cross over to the southwestern corner of Asia Minor. Here they took possession, first of the out-lying islands, Cos,



FIG. 50. — Athenian coin.



FIG. 51. — Coin of Orthia in Elis, with helmeted head of Pallas.

Calydna, Nisyros, then also of the southern coast of Caria, where the cities of Cnidus, Myndus, and Halicarnassus, were founded. After a long struggle the Dorians also succeeded in winning from the Phoenicians, about 900 B.C., the important island of Rhodes. Crete, too, was gradually occupied by the Greeks.

Several generations now elapsed before the new communities, on both sides of the Aegean Sea, fully developed into strong states. It is impossible, however, except in a few cases, to follow the details of this development. We see only, that, as early as the first half of the eighth century B.C., the Greek world has the general features which characterize it several centuries later. Apart from the newly developed power of the Boeotians in the Copais basin, the future of Greece rested now with the two branches of the Greek stock that had been scarcely mentioned in the Achaean period. While the ancient proud name of Achaeans was still used only by the remnants of the old masters, who still maintained themselves in Phthiotis, and in the new Achaia on the southern shore of the Corinthian Gulf, the Dorians had become a great people. Already,

within their Peloponnesian possessions, a political revolution was again preparing which affected the history of the peninsula as late as the Macedonian period. The leading power in the Peloponnese was at first Argos, the principality of the Temenidae, who had succeeded to the inheritance of the Atridae of Mycenae. The newly risen Dorian cities of the Peloponnese east of the Asopus valley stood at that time still in the relation of federal allies to the central city Argos. The religious bond, which united the Dorian cities grouped around Argos, was the annual sacrifices which these communities offered in common to Apollo, at the foot of the Larissa of Argos. Now, however, just at the end of the



FIG. 52.—From a representation of the Lower World. On a vase. Two of the unpunished inhabitants of Hades are represented, with a Danaïd between them, listening to Orpheus playing on his flute.

ninth and the beginning of the eighth century B.C., was effected, in the Dorian canton on the upper Eurotas, that remarkable military and political consolidation which is connected with the name of Lycurgus, and which marks the increasing power of the Spartans, who succeeded ultimately in transferring the centre of the Dorian hegemony from Argos to the south of the Peloponnese.

In the new Greece, on the islands of the Aegean and the coast of Asia Minor, Doric civilization did not attain to the same importance as in Europe.

The Ionian race had, in consequence of its migrations, almost completely changed its places of abode. Leaving out of consideration the

question, to what extent the islanders on the west coast of Greece must be reckoned as Ionians, this race had retained on the mainland only the little triangle of Attica, whose future greatness no one could at that time have foreseen. But, in addition to their old possessions on Euboea, the Ionians had spread over most of the islands of the middle Aegean, and had occupied the coast of Lydia and Caria from the mouth of the Hermus to the Gulf of Iassus. In the course of the ninth century B.C., the Ionian cities in Asia, and the Ionians of Chios and Samos, had united in a common sacrificial festival in honor of Poseidon, at Cape Mycale, in the territory of Priene. But in the spring of the year the islanders of the Cyclades united with their kinsmen from Attica and Asia, in a common worship of Apollo, on the island of Delos. The social predominance in this branch of the Greek people was for a long time maintained by the Asiatic Ionians. These supplanted the Phoenicians more and more in the Aegean sea.

The Asiatic Achaeans, though historically less important than the Ionians, are yet, as far as relates to the progress of civilization, not less interesting. In historic times, however, they appear no longer under their old and famous name, but as Aeolians. The period in which the Greek nation, which had been almost everywhere disturbed or thrown into wild confusion by the migrations and their consequences, again obtained rest and fixed abodes, seems also to have been that in which a new division of the Greeks into three chief races or race-groups was universally recognized. It is not improbable that first in Asia Minor, where the different members of the nation were not separated by any sharply physical dividing lines, the Greeks became conscious of the differences developed by slow degrees in dialect and character, such as were conspicuous enough between the Dorians, the Ionians (both of which had taken up and absorbed other remnants), and the less closely united settlers of the north. In European Greece, respect for the past probably led to the recognition of a fourth stock, the remnants, namely, of the Achaeans in Phthiotis and Achaia, who did not again become historically important until the time of Alexander's successors.

It is very difficult to characterize the individual race-groups of the Greeks during the 'Hellenic' period, and unsafe to do more than suggest the broadest features. No branch of these races belies its Hellenic character, although only a few communities have expressed it so clearly as did the Athenians in their most flourishing period. All the Hellenes had received, as a glorious inheritance, a decided fondness for the arts, especially for poetry, oratory, sculpture, and music. Sev-

eral centuries, however, passed before the ancient Greeks reached their highest development in the plastic arts, and in some branches of those of expression in speech. A strong feeling for the beautiful, as well as for the ideal, the noble, also for proportion and harmony; a sensitive taste in art, as well as in ethical conceptions, have ever been characteristic of the Greeks. A strong and quick intellectual receptivity, still more, an incomparable union of glowing fancy, brilliant intelligence, and clear understanding, were likewise at all times theirs. Impulse and passion went hand in hand. Party spirit and party rage mark the whole course of Greek history down to the fanatical conflicts of the race-course, and, unfortunately, also of the Christian sects. The proud self-confidence of the Greeks often passes over into unrestrained arrogance. Cruelty in war, even among the Greeks themselves, cunning

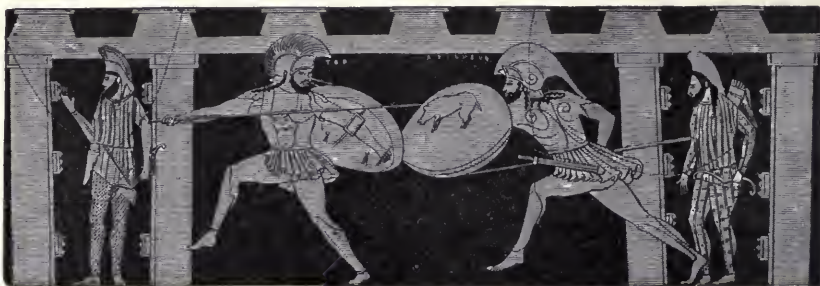

FIG. 53. — Hector and Achilles at the Scaean gate, with Trojans standing near. From a red-figured kylix. ($\frac{1}{2}$ original size.)

and artifice, selfishness and ruthless avarice, are traits which disfigure the brilliant picture of Greek civilization.

All these traits occur in the different Hellenic stems, with varying degrees of intensity. The peculiar nature and bent of the different race-groups are apparent in a striking manner in the various dialects used by them. The language of the Aeolians, marked by diffuseness and gravity, maintained most nearly the antique character. The Doric dialect, which was most closely related to the Aeolic, was noteworthy for a certain harshness and ruggedness. In its development it remained truer in point of sound and inflexion to the common Greek speech than did the Ionic, which was marked by greater softness and flexibility, a more complete vowel system, and greater abundance and variety of forms. In the chief branches of the Aeolians, the physical or sensuous side of the Greek nature predominated; and, with a few brilliant exceptions, they remained in many respects behind the

other groups in political and artistic accomplishments. The more powerful branches of the Dorian stock showed pre-eminent military talent, which was by no means restricted to war by land, since several Doric communities were conspicuous also in nautical and mercantile affairs. A natural taste for strict discipline and for morals, for order and law, and a clearly marked tendency toward an organized political life, were also characteristic of them. But the sober ways of the Dorians, and their fondness for aristocratic institutions, were united often with a harsh, haughty, and imperious disposition. Gradually, however, democratic elements gained ground, although in the Dorian communities they were not of a particularly attractive character. In speaking of the characteristics of the Ionians, Athens must, for the present, be omitted. Her unique development will be treated later on. The Ionian Greeks of the Aegean Sea and the coast of Lydia and Caria, with their later colonies, must be considered as remarkably gifted. Susceptible to all new impulses, intellectually as well as politically the most easily moved of all the Greeks, they were especially adapted to develop poetry, art, and science. Their friendly and pliant disposition made them a successful commercial folk, inclined to comfortable enjoyment of life, which, with them, readily degenerated into effeminacy. Among them there were, it is true, strong aristocratic groups, as well as brave warriors by land; but the inclination was stronger than with the rest of the Greeks to vindicate individual rights, liberty, and activity, if necessary, even against those of the community. The democratic instinct is nowhere among the Greek people more strongly developed than among the Ionians.

'Hellenes' is the collective name given to the Greek nation from the end of the migrations down to the period of the Roman Empire of the East, when the Greeks, now Christianized, were all comprehended under the name of the Romaic people. According to the view already adopted, the Greeks of the 'Hellenic' period are not to be considered a different people from the Pelasgians. The civilization and culture of the Hellenes seem to be rather a new stage of civilization into which the Greeks ripened from an earlier Achaean stage, the migration of the Thessalians and Dorians having given the last impulse to the development of this new phase. This advance of civilization subsequently separated in a very marked way, and for a long time, several Greek peoples from those branches which had developed into the 'Hellenic' character. The Aetolians, Epirotes, and Greek Macedonians do not approximate the Hellenic character till several centuries later. But the views are

very conflicting on the question, how the names *Hellas* and *Hellenes* came into use for the whole nation, — names which originally belonged only to the Thessalians and to Thessalian traditions, first near Dodona, in Epirus, and then in the part of the valley of the Peneus that borders on Phthiotis. It has been conjectured, with some probability, that these



FIG. 54.¹ — Theseus and Helena. From a Lucanian amphora; red figures on black ground. ($\frac{1}{2}$ original size.)

names were not universally in use till the middle of the seventh century B.C.; that Delphi, now the great religious centre of the race, was the spot where the new legend of the genealogy of the Hellenes and

¹ EXPLANATION OF FIGS. 42-54. (GREEK COSTUME.)

The *chiton* (shirt) is worn by Hephaestus in Fig. 47.

The *exomis*, a variation of the chiton, which leaves uncovered the right arm and right breast, is worn by Odysseus in Fig. 49.

The long *woman's chiton* is worn by Artemis Agrotera (Fig. 58). Variations of this are the *double chiton*, in which the figure on the right, in Fig. 52, and the female figure in Fig. 44, are clothed, and the *closed double chiton* in which are represented the Caryatids of the Erechtheum, the Danaïd in Fig. 52, and the Helena in Fig. 54.

The *himation* (cloak), familiar to us from the statues of Sophocles and Aeschines, is worn by the figures in Fig. 48. Women wore the himation in the manner shown by the statue of Demeter (Fig. 60).

The *chlamys*, the cloak of travel and war, is shown twice in Fig. 42.

Illustrations of *head-coverings* will be found in Figs. 42, 44, 49, 54; of foot-wear, in Figs. 42, 44, 48, 52; also in the statues of Sophocles, Anacreon, and Aeschines, and the Apollo Belvedere.

The military dress and weapons of the Greeks are illustrated by Figs. 43, 44, 53, and 54; also by numerous pictures elsewhere in this volume.

68'

PLATE III.



Antique statue of Apollo. In the Belvedere of the Vatican, Rome.

(From a photograph.)

of their chief branches was developed; and that the extension of the great Apolline Amphictyony connected with Delphi, materially contributed to the spread of the Hellenic name.

As regards the religion of the Greeks before the Hellenic period, we may remark that they did not confine themselves to the few divinities which were at first peculiar to them. Their conception of these, too, became, with every further development of their civilization, more and

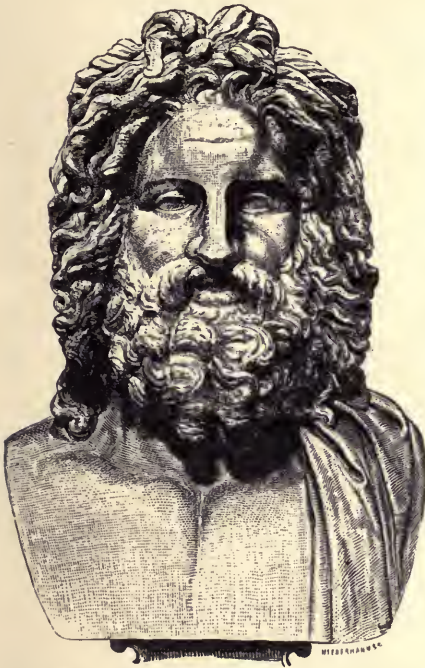

FIG. 55. — Colossal Marble Bust of the Zeus of Otricoli. Rome, Vatican. (From photograph.)



FIG. 56. — Colossal marble bust of Hera. Perhaps from an original by Alcamenes. Rome, Villa Ludovisi. (From photograph.)

more profound, while at the same time all their divinities take on forms of greater distinctness and definition.

By the side of the earlier Pelasgic deities there appear very early a number of other divine powers, the motive of whose conception is traceable partly to Greek fancy, partly to the nature of the country. Here belongs Pallas, the proud daughter of Zeus, originally the goddess of storms, and therewith also of victorious battles, the hurler of the thunderbolt, the 'untamed virgin.' As sun-god appears Phoebus Apollo (PLATE III.), the mighty god of light, who wards off dark-

ness and evil, and strikes the arrogant with his arrows (fever, pestilence, hunger, drought). As divinity of the moonlight appears Artemis, goddess also of the woods and of wild animals, the stern virgin and bold huntress. The giver of fire, the patron of the hearth, and from the Phoenician time the god of the artistic skill that depends on fire,



FIG. 57. — Pallas Athena, found at Velletri.
Paris, Louvre. (From photograph.)

was Hephaestus. As wife of Zeus, the older Dione seems to have been early supplanted by Hera, who, in the epic poems, reigns under a different character, at the side of Zeus, directs the Hours and Iris, and governs the starry heavens, — the mother of Hebe, who originally represented the ever returning youthful bloom of the earth, and of the Graces, who originally personified the spring. Dionysus, finally, was worshipped as the deity of sprouting and budding nature, as the guardian spirit of fruit-trees, of the vine, and of wine.

The worship of the various chief deities of the Greeks was naturally at first not in all cases a universal worship. In one tribe this form of worship, in another that, experienced a more distinct development, until finally a number of great deities became common to all the Greeks. In its final

form Greek mythology recognized as canonical the twelve Olympian deities, — Zeus (Fig. 55), Poseidon (Fig. 62), Apollo, Ares (Fig. 59), Hermes (Fig. 61), and Hephaestus (Fig. 63), Hera (Fig. 56), Athena (Fig. 57), Artemis (Fig. 58), Aphrodite (PLATE IV.), Demeter (Fig.



Antique statue of Aphrodite, found on the island of Melos.
In the Louvre at Paris. (From a photograph.)



60), and Hestia. Those deities, which in a stricter sense remained permanently rural, — such as Demeter and Dionysus (Fig. 64), — are not conspicuous in their early epic poetry, although they hold in the life of the mass of the free Greeks, early and late, a highly important position. Nor must it be forgotten that the descriptions found in heroic poetry — our most obvious source of information on this subject



FIG. 58. — Artemis Agrotera. Paris, Louvre. (From photograph.)

for the early period — by no means completely cover the religion of the Greeks. However strongly the epic at all times, even down to the later philosophic statement of religious ideas, affected the religious conceptions of the Greeks, a large space in their life was still occupied by traditional services and rites, which bore manifold traces of local color-

ing, and preserved certain natural or ethical traits of the character of the gods. But the spirit in which epic poetry conceived the nature of the gods, and the moral relation of men to them, ever remained dominant. The Greeks knew no dualism, no antagonism between nature and spirit. They neither yielded, like the mass of the Semitic peoples, unreservedly to nature and the power of the sensuous world; nor yet



FIG. 59. — Ares. Rome, Villa Ludovisi. (From photograph.)

did they reach the point of denying, like the Brahmins of India, their physical nature in order to please the gods. The life of the body and of the soul were by them blended in a happy harmony unknown to the peoples of the Orient. The worship of the Greek deities did not presuppose a fundamental opposition between gods and men, and did not rest on a basis of fearful anxiety or cruel asceticism. Their ethics, developed from such conceptions, bore the impress of a natural, "healthy

sentiment, of a natural moral feeling, of a naïve humanism." From the Greek, if he desired to prove acceptable to the gods, the chief thing demanded was, that he should follow the good moral impulses of his nature; while true to the demands of self-respect and thoroughly conscious of his own deserts, he should still hold in check his passions and feelings, and govern all his actions by intelligence and prudence. Sophrosyne, or beautiful and harmonious moderation, was always considered the ideal flower of Hellenic virtues.

Greek epic poetry makes it possible, further, to sketch a picture of the political and social conditions, which, though closely connected with the earlier period before the great migrations, were developed in such parts of the Greek world as especially figure in heroic poetry. The keynote of Greek life is still eminently warlike, — activity, energy, bold courage, being predominant traits. But it is no longer a time of irregular deeds of heroism; combat has everywhere very definite objects, whether of defence, or of the struggle for conquest. The forms of life bear the stamp of chivalry. There is no such thing as a brutal degradation in

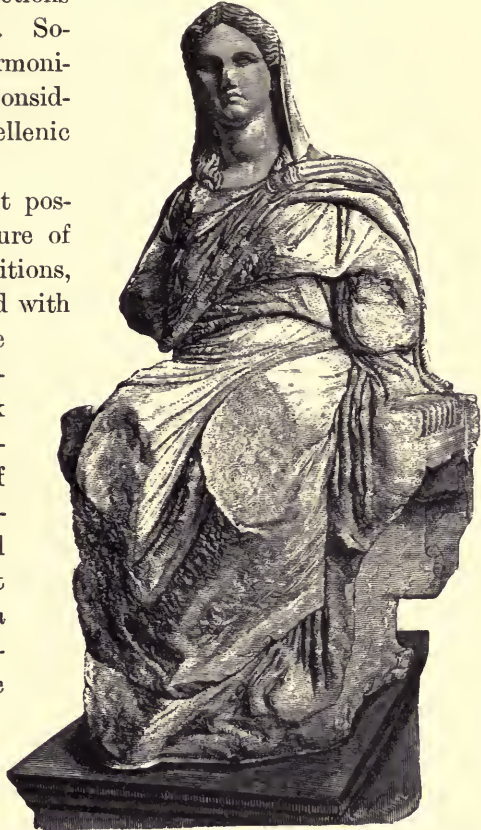

FIG. 60. — Demeter of Cnidus. London, British Museum. (From photograph.)

Greek morals. In the rising states the warlike nobility are of most importance, although they have not as yet supreme authority. Monarchy still prevails. The king, whose personality lends dignity to his office, is the leader in war. In token of his rank and power he carries a long staff, the so-called sceptre, and must outshine all others by warlike strength and skill, by heroic courage and presence of mind in battle; otherwise his own position and that of his house will be seriously imperilled. With these qualities must be coupled

princely magnanimity, superior sagacity in council, and skill in speech, in order that his decisions and commands may everywhere meet with ready obedience. The king prays and sacrifices for his people without priestly intervention; meets his nobles in open council to deliberate upon the general welfare, and to decide suits in equity or law. The



FIG. 61. — Hermes. Rome. (From photograph.)

nobles are always in the company of the king, attending him at the banquet, at military exercises, on all public occasions. The 'people,' however, the commonalty, the assembly of freemen of these small states, which are very often limited to one not very extensive municipal district, can only receive the proposals of the king and the knights, and express their assent or dissent, which they do in a loud and demonstrative fashion.

Greek life in this period is rich, brilliant, and manifold. When the sound of arms is hushed, the knights try their strength in manly games and contests, such as formed, down to the latest times, an essential feature of the Hellenic civilization. Delight in music and heroic song, in the graceful movements of the choral dance, the appetite for the rich meal

and for wine whose fire was tempered by mixing with water, marked the social gathering at the courts of princes. The homes of the leaders of the people were large, enclosed estates; and wealth still consisted not so much in land as in movable goods, although the tillage of the soil and the culture of the olive and the vine had already become of great importance. Numerous slaves, vast herds of large and small cattle, well filled treasuries whose brightest ornaments were splendid vessels of precious metal and rich coverings and robes,

characterized the princely and patrician life of the time. Their most valued treasures the Greeks still got by exchange with Sidonian merchants, who, after the ancient fashion, bartered their costly wares for captives, wine, grain, and other natural products. Among the Greeks themselves skilful handicraft is already much practised. The women understand the art of weaving garments and tapestry out of linen and wool. There are potters, carpenters, cartwrights, goldsmiths, workers in leather and bronze, and especially skilful armorers. Naval enterprise also finds vigorous expression. Fifty-oared boats were the favorites with the Greeks of this time, who, as successors to the Carians and Phoenicians, zealously cultivated commerce and also piracy. And yet even in the highest circles life still remained naïve

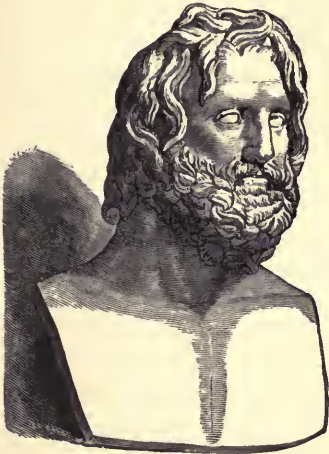

FIG. 62.—Poseidon. Rome.



FIG. 63.—Hephaestus. Rome.

and simple. The princes, who after the victory receive the best part of the booty, and at sacrificial meals and festivals the choice pieces, themselves assist in building their own houses. Their sons guard the herds from wild beasts and from enemies. Their daughters wash the clothes with their hands; and their wives, surrounded by the maid-servants, weave coverings and raiment. The rudeness of the earlier time still survives, as is proved by the utterly unprotected state of every one beyond the borders of his own country, as well as the cruel savagery toward enemies in war. Greek civilization still wavered between humane conditions, already conspicuous, especially in the grace of charming hospitality, and an ancient savagery. The relation between slaves and masters, kings and knights, was apparently a kindly

one; the intercourse between masters and slaves, unconstrained and confiding, recalling the patriarchal conditions of the Semitic Orient. The relations of family life are pure and noble. There is no trace of polygamy. Custom, indeed, and public opinion demand of the woman a much stricter fidelity than of the man, in whom intercourse with captive women, female slaves, and concubines seems to have been excused. But the position of the wife in the house is now (as later in Plutarch's time) much freer, more independent and important, than in the strictly classical period of the Hellenic people, even though only the husband or grown-up son represents the house abroad. The love and honor due to parents from children is recognized, and in other ways, also, youth willingly shows respect to age. Public opinion is already a significant power. It enforces respect for law and custom, glorifies noble conduct, brands arrogant insolence, commends a conciliatory disposition, takes hospitality under its protection, and declares the ill treatment of peaceful strangers a grievous wrong. But alongside of these traits we discover very ugly features. The errors and crimes of slaves meet with cruel punishment, mutilation, and death by torture. The condition of women, and of children under age, if they have not father or husband or grown-up brother, is deplorable; such persons easily become victims of harsh injustice, alike to person and property. Blood is very often spilt; the common custom of going always armed, and the passionate disposition of a people easily led into rash deeds, made manslaughter and instant revenge a very common occurrence. In the personal insecurity incident to such conditions blood-vengeance, which devolved on the next of kin, and beyond that on the members of the same clan, exerted a restraining influence. King and state did not interfere, but allowed such vengeance to take its course, provided the murderer did not flee the land, or succeed in atoning for his guilt by rich presents to the relatives of his victim.

The complement to the splendid picture of patrician life, preserved to us in the Homeric epics, is Hesiod's description of the condition of the peasant-class, which at that time formed, as it were, the background of Greek civilization. This description is found in the "Works and Days" of the poet Hesiod, a Boeotian rustic of the village of Ascra, at the foot of Helicon, in the territory of Thespieae. The poem belongs to the first half of the eighth century B.C. It has preserved in poetic form, but without ideal coloring, the plain prose and rough reality of ancient Greek peasant life. The class represented is not the bondmen or serfs of the country population of the Peneus valley, and of the new

Doric states of the Peloponnese, nor the so-called Thetes, the landless freemen, who were obliged to hire themselves out as servants and day-laborers on the farms of patricians as well as of peasants; but the mass of the free country-folk in the cantons of Greece proper, the hardy peasants who tilled with mattock and hoe, with plough and sickle, their fields, gardens, and vineyards. The poet, who draws directly from the experiences of life, shows us, in the advice which he gives to the members of his own class, the practice of peasant life as it had already developed, especially in central Greece. The man should marry at the age of thirty, with a girl "in the fifth year of her maidenly bloom." Servants were chosen with care. Unmarried men-servants and maid-servants were preferred. The ploughmen, who tilled the fields with strong young steers, were chosen from the slaves above forty years old. The time of sowing was determined by the so-called setting of the Pleiades (toward November). The peasant lived not uncomfortably. He was well acquainted with the wine of the mainland and of the islands, and his usual food was goat's-milk and barley bread, the flesh of calves and of small cattle. Huge dogs guarded house and garden from thieves. A large broad-brimmed hat covered the head; sandals of ox-hide, lined with felt, protected the feet; while a rough garment of sheep-skin or goat-skin protected the body from the inclemency of the weather. After the harvest was ended, the Boeotian peasants doubtless embarked on their ships, and carried the products of their fields to distant markets. But their life was not free from its disagreeable features. Laziness, selfishness, niggardliness, an envious and dishonest disposition, family quarrels, were not rare. Hesiod was well acquainted with his contemporaries, and doubtless knew that exhortations to a virtuous, peaceable, industrious life were most necessary.

It is not poetry any longer, but history, that furnishes, from the latter part of the period here described, information as to the first considerable attempt, made on the basis of one of the new conquests of the Dorians, to fix by constitution the relations of the new masters and the vanquished aborigines. Laconia was the land where this new sys-



FIG. 64. — Bust of Dionysus.
Rome, Capitol. (From
photograph.)

tem, so important in its consequences, was perfected. Nowhere in Greece, on either side of the Aegean Sea, had the Dorian conquerors met with so stubborn and persistent resistance as in the valley of the Eurotas. The position of the Dorians in Sparta had turned out to be very insecure, quite different from that in most of the rest of the new Hellenic states. While, on the one hand, the stubborn resistance of the Achaeans of Amyclae made it impossible for the conquerors to extend their dominion over southern Laconia, the Dorian territory in the northern part of this canton was the scene of serious internal disorders, the crown itself being here the occasion of continual strife. Tradition has it, it is true, that a 'double kingship' existed in Doric Laconia from the beginning. The Heraclide Aristodemus, it was said, died soon after the arrival of his people on the Eurotas; and the sovereignty having been divided between his twin sons, Eurysthenes and Procles, descended in this way to their sons, Agis and Eurypon, and their successors. This legend is untrustworthy on internal grounds. It may be maintained, on the contrary, that after the extinction of the royal branch of the Heraclidae which had led the Dorians to Sparta, there arose between two families who were likewise descended from Heracles, namely, the older Agidae and the younger Eurypontidae, bitter strife for the sovereignty, involving the Dorian people, and leading probably for a time to separate governments. Later authorities are agreed that the change from this state of affairs to the vigorous development that soon followed is to be traced to the work of a great lawgiver, of whose life and work, however, only the vaguest outlines can be traced. This man is the celebrated Lycurgus, according to tradition himself a member (though not king) of one of the rival princely families, most probably a Proclide or Eurypontide.

It is related that, after a severe defeat of his people, Lycurgus was intrusted with the regency, and, supported by the then growing authority of the Delphic oracle, appeared as the reformer of his people. Later times have been wont to trace all constitutional forms which were developed in the valley of the Eurotas, down to the establishment of the Peloponnesian alliance, to the personal agency of Lycurgus. Likewise the ruggedness of the Dorian character and the peculiar Spartan morals and discipline were regarded as his creation. But historical researches have shown that the Spartan constitution underwent a long course of development, which was not completed till the sixth century B.C. Furthermore, several features of the public life of the Spartans, which afterwards seemed so remarkable to the rest of the Greeks, can by no

means be referred to Lycurgus, however strenuously the great reformer in his effort to lift his little tribe out of wild disorder and savagery may have labored to restore the good old Dorian ways.

The political activity of Lycurgus was directed, on the one hand, toward allaying internal contentions; on the other, toward the firm establishment of Dorian authority in Laconia over the ancient inhabitants. The dispute about the crown was settled by arranging that the heads of the rival royal families should share the sovereignty equally. And the double kingship remained until the time of the Second Punic War an organic part of the public life of the Spartans. Lycurgus did not stop, however, with weakening the monarchy by this permanent division of the highest authority. Several decades before the nobles had, in other parts of Greece, wrested supreme power from the hands of their kings, Lycurgus had secured the adoption of a constitution under which the Dorian nobility of his country obtained the controlling share in the government. The hereditary division of the Dorians into three *phylae* or tribes (Hylleans, Dymanes, and Pamphylians) was securely established, and made the basis of the new constitution. Each of these *phylae* was subdivided into ten *Obae* or family unions; and the heads of these *obae*—whether the oldest heads of families or elected from the *obae*—formed now the permanent council of the king, the *Gerusia*, or ‘council of elders.’ The two kings represented their *obae* (in the *phyle* of the Hylleans), and presided over the deliberations of the *Gerusia*, the membership of which, including the king, was thirty. Not until the sixth century B.C., it seems, did it become customary for the whole of the Spartans to elect the members of the *Gerusia*. The kings were bound by the decrees of this council, and could carry on the government only in agreement with them. Besides, the *Gerusia* was now to be the highest criminal court, with jurisdiction also over all offences against the state. But neither the kings nor the *Gerusia* independently could decide about matters that concerned the whole people, least of all as to peace and war. In such cases the decision rested with the *Demos*, i.e., the general assembly of the people, but of course of the Dorian masters only, not the free Achaean subjects. Every Dorian who had reached his thirtieth year had a right to vote in the popular assembly held every full moon, but in these assemblies nothing like free debate was allowed. The kings presided. Only they and the *Gerontes* had the right to speak; and hence it was their duty, too, to give satisfactory reasons for the measures proposed, as well as so to frame them that the assembly could

decide by a *viva voce* vote of yes or no (in exceptional cases also by a division of parties). By all these regulations the ancient power of the kings was materially diminished. The Heraclidae maintained unchanged only their ancient honorary rights, and their importance as leaders of the army.

The relation of the Spartans to the ancient inhabitants of Laconia was a very precarious one. The conquered people fell into two very different classes. The condition of the one, the Lacedaemonians, or the so-called Perioeci, was comparatively endurable. Originally the part of the pre-Doric population who had, when they were conquered, retained at least their personal freedom, and, on payment of rent, also their lands, villages, and markets, the Perioeci had no share in the political rights of the Dorians, and were restricted to an exclusively communal existence. This unenslaved part of the old inhabitants had had to give up to the Spartans their possessions in the best parts of the country, the Eurotas valley, and were subject to the commands of the kings and their officials, as well as dependent on them for the administration of justice. But they retained the right, so highly esteemed in Greece, of taking part in the public festivals, and of themselves contending for prizes at the national games. Their old name, Lacedaemonians, was officially used to designate the whole population, the Perioeci and the Spartans.

The condition of the lowest class, the so-called Helots, was, however, much worse. This was the name applied by the Spartans to the old peasant population within their own territory, which had been reduced to actual bondage, and was living in hereditary servitude on the estates of the Spartans. There was in the condition of the Helots only this mitigating circumstance, that they did not belong to the individual Dorian land-owners, but were the common property of the state, which leased them, as it were, to the individual Spartans. The latter could not of their own accord set them free, nor could they sell or kill them. The Helot families were settled on the Dorian estates, tended the fields, gardens, and vineyards, pastured the herds of their masters, and were obliged to return to them half of the products of the harvest. The attitude of the Dorian community toward the Helots remained always a fearfully oppressive one. The more the number of Helots increased, as Spartan authority was extended to the Laconian Gulf, and then over Messenia, the harsher became this relation. It remained always an incurable cancer in the body politic, and often seriously threatened its very existence.

The attitude of the Dorian community toward the ancient inhabitants of the country was that of an exclusive nobility. The maintenance of this relation was essentially promoted by the regulations made by Lycurgus to secure the military ascendancy of the Spartans, as well as to remove inequality among them. The critical position of the Spartans between their subjects and the still unsubdued Achaean inhabitants of the south, made it necessary that the Laconian Dorians should be concentrated in Sparta, and that they should be able, at any moment, to present themselves, disciplined to arms, and ready for battle. Lycurgus and the statesmen who continued his work devised a rigid course of training, which severely disciplined the young Spartans from their youth up, and appropriated all their physical and intellectual powers for the public service. To this they attached an organization which made all men from twenty to sixty years of age thoroughly drilled soldiers, so that the Spartans were for several centuries the best warriors of Greece. Lycurgus added to these still other far-reaching regulations. He made provision to prevent the Spartans from being withdrawn from military service by agricultural, industrial, or mercantile pursuits. It was not hard to induce the proud conquerors to leave all agricultural labor to the Helots and Perioeci, and to the latter all trade and industrial activity. To the Spartans were assigned extensive estates, which were tilled for them by the Helots. The next matter of importance was a division as nearly equal as possible of the Helot families among the Dorian proprietors. The estates were neither to be sold nor subdivided; even the division of inheritances was not allowed. Property descended, it seems, by primogeniture. The younger sons lived, under the direction of the eldest brother, from the income of the common inheritance. But in the most flourishing period of Spartan history the surplus of younger sons was, for several generations, provided for out of the new Messenian conquests.

The military character of this state, whose men, capable of bearing arms, were always ready for war, found its most immediate expression in the common meals, or *Syssitia*, of all the Spartan men of twenty years or upwards. The tent-messes, or *enomotiae*, of fifteen men each, took in common a plain meal, to which was sometimes added wine, flesh offered in sacrifice, and game. The participation in these *syssitia*, and the furnishing of contributions toward the expense incurred, became an essential condition of the Dorian citizenship of Sparta. The *enomotia* itself was the lowest tactical unit in the army; two of these formed a *triakas*; and several of these again were united in a

company. Whether the whole military force of Sparta, in this early time, can be reckoned at five *lochi* ('battalions'), cannot be determined. For a long time military service in these divisions was restricted to Dorian men, who were attended, of course, by shield-bearers, baggage-carriers, and sappers from the Helots. Not until the complete consolidation of their power could the Spartans dare to lead the hardy Perioeci into battle as hoplites, or heavy-armed troops.

The Achaeans in Southern Læonia, and all the neighboring states of the Peloponnese, were to learn soon enough what it meant, that by the strong hand of Lycurgus the condition of anarchy on the upper Eurotas had been brought to an end and the strength of the Spartans united and organized. Lycurgus's entrance into public life probably belongs, not to the year 884 B.C., which is the old view, but to the last third of the ninth century B.C. Again, it is no longer believed that Lycurgus induced his people to take part in the celebration of the Olympic games. The Aetolian conquerors of Elis had got control of the ancient festival, with the accompanying games, which the Achaeans of Pisa — now their subjects — had been wont to celebrate on the lower Alpheus, in honor of Olympian Zeus.¹ From the beginning of the eighth century B.C., it was celebrated every four years in time of peace by the Eleans and their neighbors, the Pisans, Caucones, Messenians, and the Achaeans of Aegialea. This festival, which continued to be celebrated until 393 A.D., became the basis of the only universally accepted chronological system among the Greeks. They counted backward to the Olympiad at which Coroebus, the Elean, was victor, 776 B.C. But whether this was really the first Olympiad, is a question into which we will not enter.

¹ The connection of this festival with the legend of Heracles dates probably from the time of King Phidon of Argos.

PART II.

FROM THE FIRST OLYMPIAD TO THE REVOLT OF ARISTAGORAS OF MILETUS.

(776-500 B.C.)

CHAPTER IV.

THE COLONIAL EXPANSION OF THE GREEKS.

DOWN to the time of the Persian wars, the spirit of political individualism and the principle of separate development prevail in the most decided manner among the Greeks, and not till then does the history of the different Greek states and alliances unite in one majestic stream, whose course we have simply to follow. Nevertheless, there belong even to this period several great characteristics, which make it possible to sketch, in large outlines, the general history of the numerous members of the Greek nation. To this period belongs the first work of the Greeks of world-wide importance, namely, their colonial expansion over a very large part of the coasts of the Mediterranean and adjacent waters.

With the Dorian migration, and the spread of the most energetic Hellenic tribes over the islands of the Aegean Sea and the western coast of Asia Minor, the adventurous spirit of the Greeks, with its predilection for the sea, was cherished and developed. The new harbors, especially on the eastern coasts of the Aegean, became starting-points for the numerous voyages of discovery to the more distant coasts of the Mediterranean. And these were followed by still greater bodies of adventurous colonists, who at ever greater distances from the old countries won permanently for Greek civilization new parts of the 'barbarian' shores. Before the time of Alexander the Great the Greeks were not fond of removing far from the sea, or at least of making conquests for colonial purposes. They were everywhere content, to use Cicero's expression, "to weave an Hellenic border on the lands of the barba-

rians." However that may be, it appears that the peninsula between the Gulfs of Ephesus and Smyrna, the peninsula of Troas, Chalcidice, and in the west the present Calabria, were entirely subjugated by them. The Greeks were influenced by very various motives in founding their many new colonial cities. First, commercial interests gradually developed, in very many cases, large cities out of simple factories. Besides, there was the necessity of suitably providing for the excess of the rapidly growing population at home. A powerful motive, too, from the middle of the eighth far into the seventh century B.C., was the party factions that raged within the walls of numerous Greek cities. When the democratic element began to be roused against the oligarchy, the ruling families opened the way for the emigration of the restless elements. Later, again, the old nobility were often driven into exile by the tyrants, and still oftener by the fierce feuds which in the course of further development often broke out between the old families and the common people. There was, of course, no definite, distinctly conceived national purpose in the Greek colonization, further than that the experience and intelligence of the Delphic priesthood repeatedly gave the right direction to separate expeditions.

It was not in the nature of the Greeks to establish real colonial empires, and hence there seldom existed between the colonies and the mother-city other bonds than those of common worship, filial respect, and trade.

The Asiatic Ionians dominated especially the Black Sea and the straits connecting it with the Aegean; but the Hellenic flag was unfurled also in the eastern parts of the Mediterranean, and finally was even planted in the delta of the Nile. The Ionians of Euboea directed their activity partly to the three-pronged peninsula of Chalcidice, partly to the coasts of lower Italy and Sicily. In lower Italy they met with strong competition from the Achaeans, who had yielded to the pressure of the Spartans in the Peloponnese. The Dorian colonization was directed, under the Megarian flag, especially to the Bosphorus and the Black Sea; under Corinthian leadership, to the east coast of the Adriatic, and to Sicily. The Celtic and Spanish West became the domain of bold Ionian seamen.

The spread of the Hellenes over the coasts and islands of the Mediterranean was concluded about the middle of the sixth century B.C. The Black Sea, and the waters as far as the outlet of the Hellespont into the Aegean Sea, belonged almost entirely to the Greeks. Here arose large Greek cities, like Trapezus (756 B.C.), Sinope (after

780 B.C.), Heraclea in Bithynia (founded by Megara about 559 B.C.). The seventh century saw the rise especially of the Ionic colonies on the north and west coast of the Pontus, of which the celebrated Olbia (after 644 B.C.), at the mouth of the Borysthenes, survived till a late period of the Roman Empire.

Of the greatest importance for the later history of the Hellenes was the colonization in the western part of the Ionian Sea. The Hellenization of a considerable part of Lower Italy and Sicily made the mother-country a central Hellas; for there was now an Hesperian or western wing of the Hellenic world as well as an Asiatic or eastern one. The Greeks of Italy, the Italiotes, exercised the profoundest influence on the civilization of the kindred Italian peoples, while the contact of the Greek Siceliotes with the great oriental colonial power on African soil, the Phoenician (Punic) Carthaginians, produced important results. In Lower Italy the Achaeans founded after the last third of the eighth century B.C. a new Magna Graecia ('Greater Greece'), whose flourishing agricultural colonies, like Sybaris (after 720 B.C.), Croton (after 710), Metapontum (about 600), and others, covered the whole territory from the borders of the Ozolian town, Locri Epizephyrii (about 700), up to Posidonia. Of Ionian cities, there was Cyme (about 735 B.C.), the forerunner of other Greek settlements at the foot of Vesuvius, and Rhegium (about 715), both founded by Chalcidian Ionians; while the Dorians had Tarentum, a colony sent from Sparta (707 B.C.) Lower Italy, from the line between Hyele and Tarentum to the strait of Rhegium, was for several hundred years Greek territory.

In Sicily Ionian and Dorian settlers began the work of colonization about the same time. Driving back, or subduing and Hellenizing, the aboriginal Sicels, — of a race cognate with the Greeks, — Chalcidian and Naxian Ionians founded the city of Naxos, 735 B.C. Then followed Leontini (729) and Catana, and about 720 the Ionian Zancle opposite Rhegium. The Corinthians and Megarians had likewise found their way to Sicily. As early as 734 B.C. Ortygia, the old city of Syracuse, was founded by Corinth. This place in turn sent forth, only two generations later, other new colonies, among which was Enna in the middle of the island. Cretan and Rhodian Dorians settled at Gela (690), on the southern coast. And when the Megarians had founded Selinus (628), on the southwestern coast, and Rhodians and Geloans had planted the flourishing colony of Agrigentum (581 B.C.), the great eastern half of the island was everywhere covered with Greek settlements, up to the border-line of the old Phoenician colonies on the west.

The Greek settlements west of Sicily and east of Caria play a comparatively small *rôle* in Greek history. In the Celtic west must be mentioned the Phocæan Massalia (after 600 B.C.), now Marseilles, which was for centuries among the Celtic tribes of southern Gaul the representative of strong municipal feeling and genuine Greek culture, and came early into intimate relations with Rome. Of special importance for the general history of Greece was, in the eastern part of the Mediterranean, the Phœnician Cyprus, which in the first half of the seventh, but more especially in the sixth century, was permeated with Greek elements of various tribes. The powerful colony of Cyrene, in Northern Africa, which was founded under the direction of the Delphic oracle by Minyans and Dorians of the island of Thera (633 B.C.), having been early cut off from all close connection with the main body of the nation, was especially affected by its rivalry with Carthage and by its relations to the oriental rulers of the valley of the Nile, and showed a strong African trace in its character. Naucratis, finally, an Ionian colony which flourished in the Delta of the Nile during the sixth century, obtained its importance from its relation to the people of the Pharaohs.

On each of its territorial extremities Greek colonization met with powerful opponents, who long checked the further compact expansion of the Hellenes. Even during the seventh century B.C., the Greeks on the west shore of Asia Minor were in constant conflict with the growing power of the Lydian Mermnadae. And in Sicily the situation became critical when the Tyrian Carthaginians united the Phœnician colonies in Africa, Sicily, and Spain into one great empire. In alliance with the Etruscans, and with some of the native Sicilians, they were able, soon after the second third of the sixth century, to check permanently the farther advance of the Greeks in the west.

We shall subsequently endeavor to explain how the conflicts of the Greeks with the great powers of the Orient affected the development of those political influences which led first to a short-lived pan-Hellenic unity, then to a grand dualism. Up to the time of this conflict, the unity of the Hellenes was simply one of spirit. In politics at this time the individualistic tendency decidedly dominated Greek life. Except several united states of some extent, such as Laconia and Attica, the City was everywhere the State, and the colonial cities especially covered a territory of considerable extent. The political alliances developed in some cantons, like Boeotia and Argolis, or in larger territories occupied by the same race, especially among the Asiatic

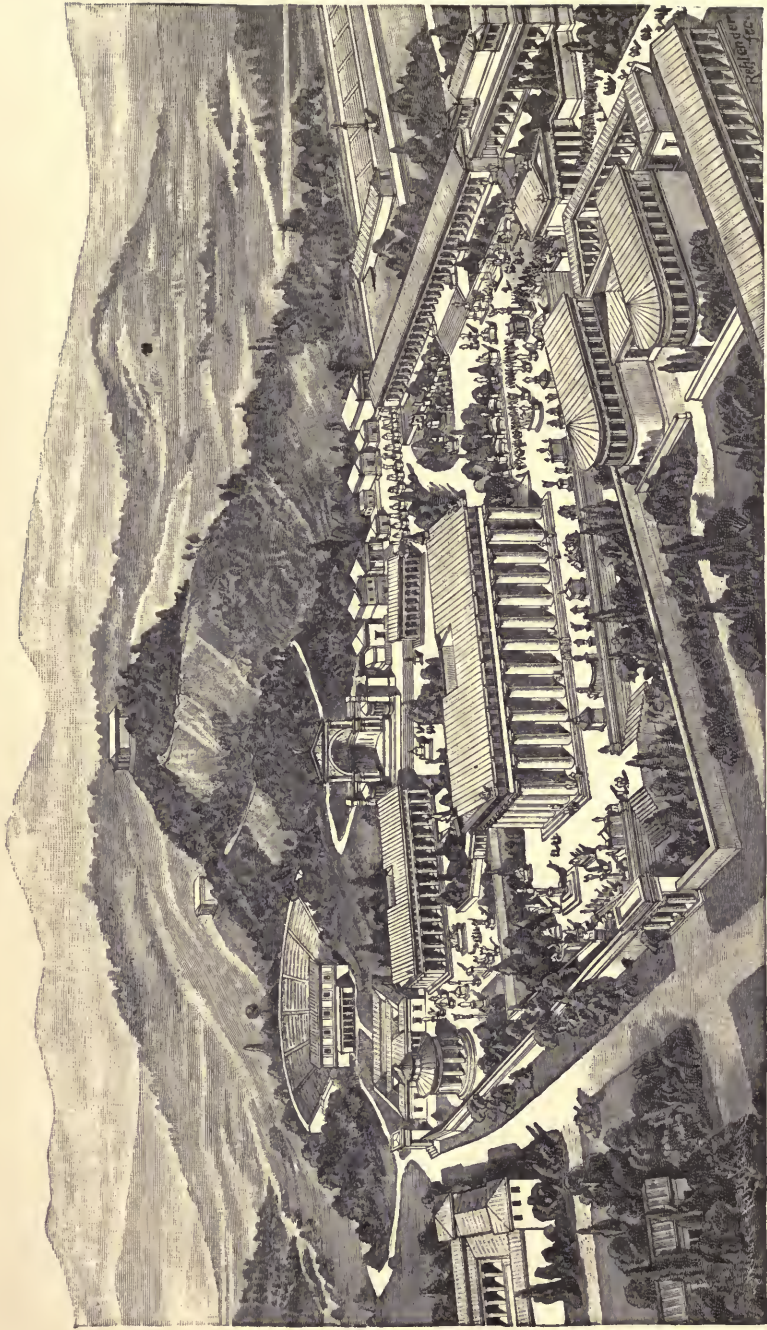

FIG. 65. — View of Olympia. (Restoration.)

Ionians, did not represent compact political bodies. Common religious sacrifices did not by any means prevent quarrels between the allied cities on all occasions. Indeed, feuds between Hellenic communities were the order of the day. Such conflicts seldom involved a large circle of cities. This happened, it is true, in the war which was carried on from about the beginning to the middle of the seventh century, between Chalcis and Eretria, for the possession of the rich Lelantine plain in Euboea, and which spread over the whole archipelago, after Miletus had taken the part of Eretria, and Samos, Chalcidice, and the Thessalian knights had espoused the cause of the finally victorious Chalcis. Later still, the acts of violence done by the Phocian inhabitants of Crissa, to pilgrims going to Delphi, was the occasion of the long so-called First Sacred War. At that time Athens, the Thessalians, and Clisthenes, despot of Sicyon, united (592-583 B.C.) against the Crissaeans, conquered first their city (590), then Cirrha, their fortified seaport (589), and finally overcame the last opposition in the mountains.

The mention of Delphi brings to mind one of the most powerful bonds of union that held together the Greeks of this age. The common Hellenic national feeling, as opposed to the outside world, had not attained its keenest intensity, — the result generally of a struggle for existence. Happily for the Hellenes, there were, however, at least two points in the mother-country which were dear and sacred to all branches of the nation, in whose jurisdiction for centuries the intellectual interests of all the tribes met. These were Olympia and Delphi. The development of the authority of the aristocracy of nobles, in almost all parts of Greece, toward the middle of the eighth century B.C., and in connection therewith the attention paid to bodily exercises and equestrian games, which were carried to the highest degree of artistic perfection; further, an eager ambition and a lively delight in the beautiful, — all made it most natural that the festal games of Olympia, receiving fresh encouragement from Iphitus of Elis and from the Spartans, should become of great significance. The Dorians beyond the Aegean, the hardy nobles from Attica, the patricians of Ionia, the knighthood of Boeotia and Thessaly, the Siceliotes and Italiotes, soon found the way to the plain on the lower Alpheus. About the middle of the seventh century B.C., the sacrificial festival of Zeus of Olympia became a national pan-Hellenic celebration (Fig. 65).

The Olympic festival was kept up until the last breath of antique life, and ever was in the highest degree characteristic of the native bent

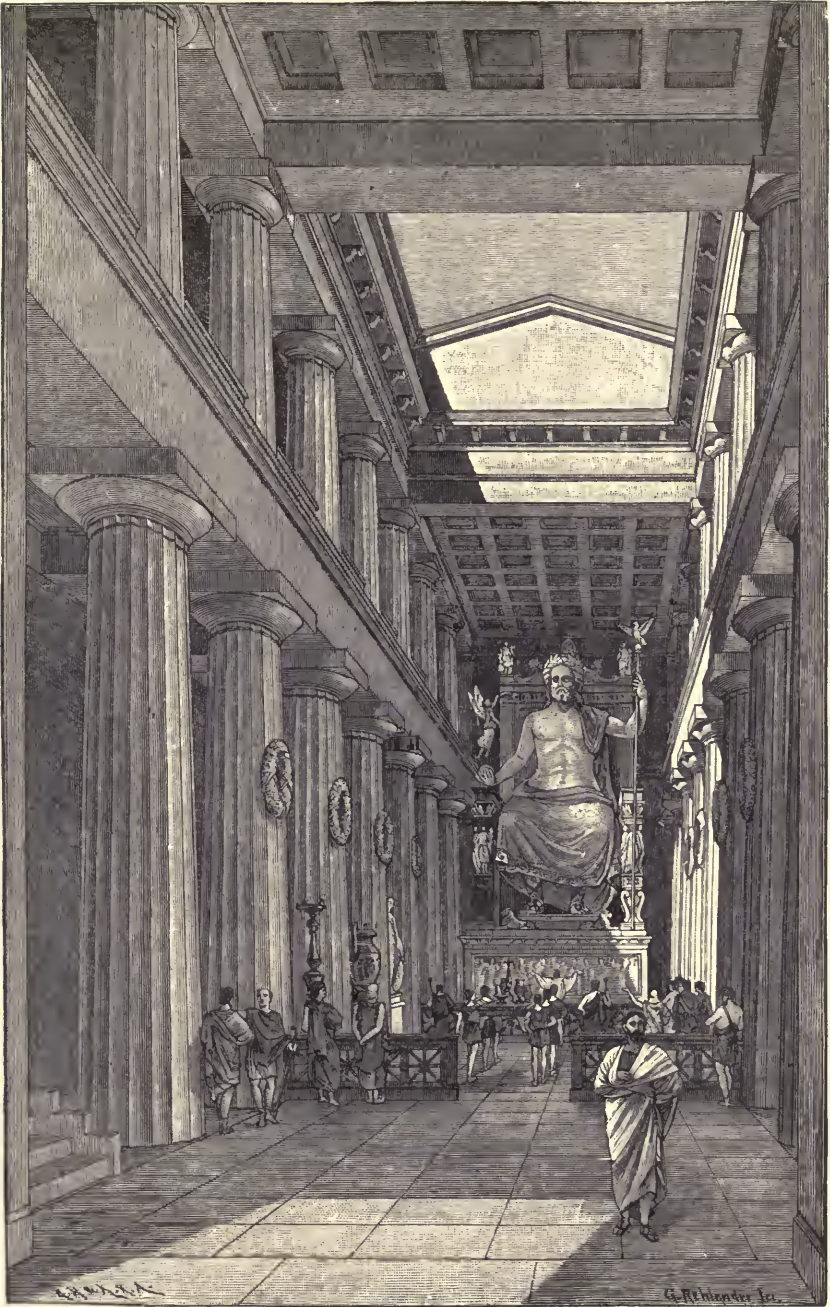

FIG. 66. — The Cella of the Temple of Zeus at Olympia, with the colossal statue of Zeus by Phidias. (Restoration.)

of the Greeks. Every four years, as the moon drew near the full after the summer solstice, the Elean heralds of Zeus proclaimed a sacred armistice (or truce of God) throughout Greece. The delegations and throngs of contestants that streamed toward Olympia from all parts of Greece received safe conduct even through hostile territory. During the festal month no one was to bring arms into the land of Elis; and in the Peloponnese at least there was to be a truce at arms. The authorities of Elis had and exercised the right to exclude from participation such communities as had violated the truce or other ordinances of the festival until the wrong was expiated by heavy fines. As soon as the invitation had gone out in all directions, the most powerful and brilliant from all the Greek tribes assembled at the city of Elis. From here they went in procession, with animals for sacrifice, along the Sacred Way, to the plain of Olympia, over fourteen hours distant.



FIG. 67. — Elean coin of Hadrian's time, with the image of the Olympian Zeus.

Here were buildings belonging to the sanctuary of Zeus, the spaces for the games, and the dwellings of the priests, together with some inns. Now, however, sprang up for the time an extensive city of tents. The festival was opened with the great sacrifice to Zeus in the Altis, the sacred grove that encompassed within a wide circuit the sanctuaries, and in whose midst rose the mighty altar of Zeus. Then, in the presence of countless spectators, only married women being excluded, the games began. Until 708 B.C. the games were confined to various kinds of races; from this time onward the programme of the festival became more and more varied. At different times were added wrestling; the so-called pentathlon, consisting of the standing jump, the simple race over the stadium, throwing of the discus, hurling of the javelin, and wrestling; boxing; the four-horse chariot-race, the horse-race; the so-called pancratium, a peculiar union of wrestling and boxing; also certain contests for boys. Gradually the festival, to which in later times musical and literary exhibitions lent new charms, was prolonged to five, even to seven, days. (For illustrations of athletic contests, see Figs. 68–75 and PLATE V.¹)

¹ EXPLANATION OF PLATE V.

Taking the groups in order from left to right, we have first a combined wrestling and boxing match between two youths. One has thrown his left arm around the head of his antagonist, and covers his mouth and nose so that he cannot breathe. At the same time he fetches a blow on the chin with his left knee, and draws back his right hand for a stroke that shall finish the contest. The other, already almost helpless, attempts with

PLATE V.





Athletic Sports.

Arranged from the fragments of two cylices by the vase-painter Duris. In the Berlin Museum.

History of All Nations, Vol. III., page 90.



FIG. 68. — Ephebus hurling javelin. (See note on p. 93.)

his right knee to ward off the coming blow, and raises the index-finger of his right hand as a signal that he confesses himself vanquished.

Next follows a discobolus; with bowed head, right hand resting on the hip, and left foot somewhat advanced, he adjusts the discus for a left-handed throw. His discus is distinguished by the figure of a flying owl.

The third group depicts three youths with *halteres* ('jumpers,' a kind of dumb-bell). The first and third hold both halteres in the left hand, and have raised their right hands with a gesture which seems to indicate that they are leagued against the intermediate figure, who — both arms stretched far forward with the halteres, the upper part of his body somewhat drawn back, and the left foot advanced — is upon the point of leaping backward.

The next figure has in his right hand a grooved staff raised to throw; he holds another in his left hand.

The figure behind the staff-thrower is an overseer, recognized by his uplifted forked staff. He is clad in a himation, only a part of the right side of the bust remaining exposed. He walks toward the left, but turns back his head to look at the next group (immediately beyond the right handle of the cylix), which represents a boxing-contest.

The hands of both boxers are bound with thongs. The struggle is already decided. The victor is bleeding from the nose and from a wound in the neck; but he has already raised both fists to strike down completely, by simultaneous blows, the collapsing adversary. The vanquished contestant protects his head with his left arm, and raises the index-finger of his right hand as a token of defeat.

The column without a capital, which comes next, is a *meta*, the goal of the race-course, already passed by a race-chariot drawn by four horses, before which runs a hound. The bearded driver wears a long, sleeveless chiton, with a double outer garment. He holds the reins and whip in his outstretched hands. The reins come together between the two middle horses. The outer horses are somewhat in advance.

The athletic contests are taken from the fragments of one, the charioteer from those of another, of the two cylixes of Duris, which are here combined. [Duris was a famous Athenian vase-painter, who flourished *circa* B.C. 510–480. — ED.]

Down to 580 B.C. a judge chosen from the posterity of king Iphitus (of the house of Oxylyus), after this the two 'Hellenic judges' chosen from the nobility of the Eleans, had to examine the contestants to ascertain whether they were of Hellenic descent and freeborn, and innocent of the shedding of blood. Then at the altar of Zeus Horcius the contestants took an oath that they would use no unlawful means in their contests. The games were opened with a flourish of trumpets, the herald made proclamation; the contestants prayed, and then drew



FIG. 69. — Antique statue of a boxer with boxing-gloves. Dresden (After Clarac.)



FIG. 70. — Antique statue of an athlete cleansing himself with a scraper after combat. the so-called Apoxyomenus. Rome. [After Clarac.]

the lots from the silver urn. The prize of victory was only a symbolic one,—in Olympia a wreath made of sprigs from that olive-tree Heracles himself was said to have planted; at home splendid honors and never-fading glory for the victors. Even in the second century of the Roman empire, the Olympian crown of victory meant as much as a patent of nobility in modern times. But the Olympian festival, with which a busy fair naturally connected itself, developed, in the best periods of Greek history, into a sort of periodically recurring national assembly, where the citizens of this great nation, extending now from the Rhone delta and the west of Sicily to the Colchian Phocis, the Nile,

and the plateau of Cyrene, met in a brilliant company. At Olympia the Greeks became more and more conscious of their national power and essential unity as a people.

Of the other games of a somewhat pan-Hellenic character, which were instituted in the Peloponnese, on the model of the Olympian, the Isthmian, near Corinth, attained to great importance after 587 B.C., and the Nemean after 573. But they had by no means the same national significance as the festival of Zeus on the Cladeus. It was different with the Pythian games, on account of the immediate connection with the oracle of Delphi in Phocis, the spiritual capital of the Hellenes.



FIG. 71. — Ephebus provided with halteres for jumping.¹

A deep religious sense at all times characterized the Greeks, which, among other things, impelled them to put everything under the protection of the gods, and in all matters, so far as possible, to secure the approval of the deity. They would enter upon no undertaking without favorable omens. They lived in the conviction that the gods manifested their will to men by thunder and lightning, by flight of birds, rustling of the leaves of sacred trees, and by peculiar signs in the sacrifices.

¹ Figs. 68 and 71 are engraved on both sides of a bronze discus, 20 centimetres in diameter, almost 2 kilograms in weight; found in Aegina. (From the original in the Royal Museum at Berlin.)

By far the most important of the oracles of Greece, and for that matter of the ancient Pagan world, was that of Apollo at Delphi. Pytho, the ancient place of sacrifice belonging to the territory of the Phocian Crissa, was situated near Delphi, on a plateau on the southern declivity of Parnassus, beneath two towering peaks, and close by a cavern from which stupefying vapors rose. It appears from the time of the Dorian migration in the possession of Apollo and connected with Apolline prophecy. A woman, who had been thrown into convulsions by the vapors, announced the oracles. This Delphic oracle gained

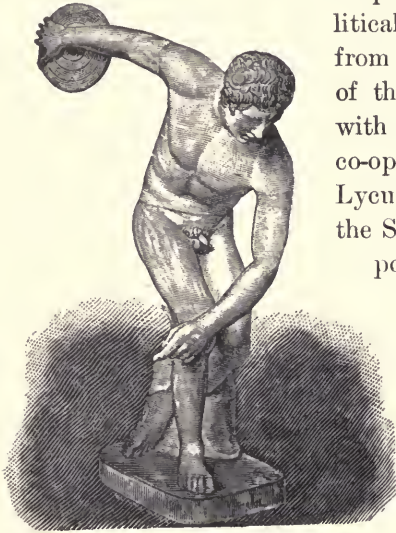

Fig. 72.—Antique marble statue of a discus-thrower. Probably after Myron's original. Rome, Vatican. (From photograph.)

its paramount importance first through political circumstances. On the one hand, from the time of the victorious appearance of the Dorians it stood in intimate relation with this new chief power of Greece. The co-operation of Delphi in the reforms of Lycurgus, and the fresh impulse given to the Spartans by this reorganization of their political life, increased also the reputation of the oracle. On the other hand, its intimate connection with the great pan-Hellenic Amphictyony was of material aid to it.

The oracle was managed as follows. In the aristocratic government of the city of Delphi several old noble families, as the Thracidae and the Laphriadae, chose from their number a col-

lege of five men, with life-tenure, the so-called 'sacred ones,' who were intrusted with the oversight and direction of the sanctuaries. These five appointed the priests of the temple, the soothsayers, and the so-called Pythia.¹ The Pythia was a robust young woman of respectable family, daughter of a citizen or a peasant, and pledged to a chaste and quiet life. In earlier times only virgins, later, women of advanced years, were selected for this position. In the earliest period the oracle could be consulted only once a year, in the spring; but after it had grown in importance it gave replies usually on the seventh day of each month. One had to undergo a preparation of several days before consulting the

¹ Three such priestesses were connected with the oracle in its most flourishing period, in a very late period only one.

oracle, to be purified by the Castalian fount, then crowned with laurel to offer a sacrifice to Apollo. After this he descended into the hall built over the cavern, where the Pythia, prepared for her duty by a three days' fast, took her place on a bronze tripod over the steaming cleft. The words uttered by her when thrown into convulsions by the vapors were caught by a soothsayer, formulated, — from the beginning of the seventh century usually in dactylic hexameters, — and communicated to the interrogator.

It has long been customary to treat the Delphic oracle as synonymous with cunning priestcraft. But this can hardly have been the



FIG. 73. — Antique group of wrestlers, the so-called Pancratiasts. Florence.
(From photograph.)

case. In Delphi's best period it was not a question of prying into the future. The object in consulting the oracle was for a long time to get, in a number of important interests of political and religious life, from an impartial source good advice sustained by the authority of the god. And among the Delphic priesthood there was without doubt for centuries an honest belief, that they were in a position really to discover the will of Apollo, and best able to give the expected advice. And up to a certain point they actually were able to do this. Through the connections of the oracle, extending over all parts of the Greek world, there streamed into Delphi news, information, experiences, of the most varied kind; and among the priesthood of the temple there were gradually

developed a very definite tradition and a sure practice in utilizing this knowledge. Though the main purpose was to announce what must happen under given circumstances, Delphi wielded a decisive religious influence. It inculcated awe before the gods, emphasized the liturgical and ritualistic side of worship, opposed the division and multiplication of religious services, worked for the development of the fixed canon of twelve chief deities, as well as to prevent the arbitrary introduction of new gods, festivals, and cults. Delphi took, moreover, an active and successful part in the improvement of morals. It was a fact of great importance that the priesthood developed a definite system pertaining to the shedding of blood. They succeeded in impressing upon the passionate Greeks the consciousness that murder and homicide were a most grievous and wicked pollution, and so, by proposing an extensive system of blood-atonement, effected among all cultivated members of the nation the gradual abolition of revenge for bloodshed and the development of a new law relating to homicide which was administered by the



FIG. 74. — Preparation for the chariot-races; mural painting in an Etruscan sepulchre. (After Miceli.)

state. On the political side Delphi repeatedly exercised an active influence on the prudent administration of new colonies. During the eighth, seventh, and sixth centuries B.C. it was rare that in the Hellenic world any organic change of special significance was made, anything of general importance attempted, without first consulting Apollo, the prophet of the most high Zeus. Even foreign people and kings thought it well to ask advice at Delphi. In this place too, rendered safe by its sanctity, Greek communities deposited great treasures, and Delphi thus became the centre of an important banking business. But Delphi was not in a condition to establish an efficient form of national unity among the Greeks, or even to put a stop to the ceaseless feuds between the different states. And finally a very great evil manifested itself in the holy seat itself. At Delphi rigid aristocratic rule prevailed. When in the course of events in a great part of Greece, even in the Peloponnese, the rule of tyrants began to shake the authority of the nobles, the oracle itself perhaps became involved. Thus its impartial objective attitude ceased; and in the sixth century a period ensued in which not

only the old large conception gave place to a fondness for intrigue and cunning trickery, but even the voice of the Pythia was bought for political purposes.

Hellenic federal unity is dimly shadowed forth, hardly more, in an institution which was from the earliest time directly connected with Delphi, — the great Delphic Amphictyony. Like almost all points of importance in the earlier history of Greece, the development of this greatest of all the Greek amphictyonies is a difficult problem to solve. From the first half of the eighth century B.C. we find it under the form of a peculiar federal constitution, which, though undergoing many changes, lasted till a late period of the Roman empire. Twelve larger



FIG. 75. — Horse-race, reaching the goal: the victor received by the judge. Vase painting. (After Gerhard.)

and smaller Greek tribes formed this alliance, all equally represented in the assembly known as the Pylaea, which met at Anthela, near Thermopylae. It was the duty of the Pylagorae to provide for the good order of the festival, for the performance of the sacrifice, the safety of the sacred embassies, and for the protection of the holy place. When, as it seems, not long afterwards the members of the amphictyony had entered into close relations with Delphi, and had bound themselves by oaths to protect the sanctuary of Apollo, the meeting was held twice a year, in September, and in February or March. By the seventh century B.C. the great majority of all Greek states had obtained representation in this association. This union of the Hellenes was confined, it is true, to the sphere of religion. On the political side this alliance never did anything toward a closer union, or even for the adjustment of internal differences. If one of the allied cities observed the ancient agreements, in case of mutual wars, at least, not to destroy any amphictyonic city, nor cut off drinking-water from it, nothing more was demanded.

CHAPTER V.

GREECE IN THE TIME OF PATRICIAN RULE.

A CONNECTED history of Greece before the sixth century B.C. it is perhaps impossible to sketch. We can, however, trace certain general characteristics in the political development of the Hellenes. Not long after the beginning of the Olympiads, the constitutional life undergoes signal development. The first noteworthy feature is the universal disappearance of the ancient monarchical forms of government. With the exception of Macedonia, the Epirot Molossians, and the Spartans, there were, after the second half of the eighth century B.C., no kings among the Greeks. Everywhere the noble aristocracy of knightly patricians took their place. This development was inevitable. With the strengthening of well-ordered conditions, and the lack of powerful foreign enemies which could make the continuance of a vigorous monarchy necessary, the importance of great families beside the throne increased everywhere. Different as may have been the development of the patrician order in different regions, the same tendency to abolish the monarchy altogether became everywhere manifest during the eighth century B.C. The manner of the transition to the rule of nobles was different according to circumstances. Only in rare cases does it seem to have been attended by bloody acts of violence; and indeed, as soon as the noble families rose as a compact mass against the monarchy, the kings had no means of defence. Wherever some personal conflict, or the wantonness of some monarch, did not precipitate a violent outbreak, the decay of a dynasty, or the want of unity among the heirs to the crown, enabled the nobility to prevent reoccurrence of the throne. Sometimes, also, the princely power was changed into a responsible office to be filled for a short period only, or the functions of the rulers were limited to few and narrowly defined privileges; or they retained only their hereditary priestly functions.

In the second half of the eighth century B.C., in all the Greek lands, even Sparta included, the aristocracy of nobles had succeeded to power; and this condition in many places continued till long after the Peloponnesian war. From the moment when the government of these common-

wealths fell to a number of free citizens, the duty became urgent of organization on a constitutional basis. The principle of determining the measure of political rights by corresponding duties and services is now for the first time introduced among the Greeks. The separation of the legislative from the executive power, and the establishment of fixed offices which should be filled by responsible officials limited to a short term of office, become now distinctive features of Greek political institutions.

Though the new aristocratic constitutions showed in smaller details great variety, certain features were everywhere common to them. An assembly of the people, the so-called *demos*, was perhaps nowhere wanting; only its power was still very much restricted, and it is questionable whether the popular assembly had everywhere even the limited measure of rights that it possessed at Sparta. Though the *demos* everywhere may have had the right to approve or reject the proposals of the government, it probably had by no means in all places the right of taking part in the choice of public officials, who could, moreover, be taken only from the ranks of the patricians. The form of the ruling advisory council was characteristic of the aristocratic *régime* in Greece. Besides the higher magistrates, into whose hands was given the conduct of the government for a longer or shorter time, the patrician chiefs usually established a double council. There was ordinarily a great council, which is to be regarded as a comprehensive representation of all noble families, and which assembled only to discuss great state questions, and a smaller or real council of state. This latter, in aristocratic governments, was regularly called the Gerusia, 'consisting of old men,' who held office for life. Originally, as a rule, they were the chief leaders of the patricians or of the different patrician groups; later they were chosen by election.

The power of the Greek nobles, known at a later date as Eupatrids, was for several generations as firmly and securely established as that perhaps of the Roman patricians only in their best days. After the overthrow of the monarchy, there was for a long time no one who could have disputed the sovereignty with them. And indeed for several generations the Greek nobility showed themselves worthy of their new positions. This class of society was at that time really filled with a high and noble sentiment. Free from feudal habits, still far removed from the evil inclination to use the state in the interest of their own class, guided by noble public spirit, they were fully conscious of their duties toward the commonwealth. Their commanding position was

counterbalanced by corresponding grave duties. The defence of the commonwealth, and for a long time, too, its burdens and labors, fell almost entirely on the patricians. The whole religious, musical, and gymnastic education of the young nobles was calculated to nourish and preserve exalted ideals in the spirit of this period (Fig. 76). However proudly they looked down on the commons, on the peasant, commercial and industrial masses, even these did not refuse them respect, so long as they really maintained this knightly spirit, and performed their duty faithfully and successfully. They established themselves in power as strongly as possible, that their power might hold firm even

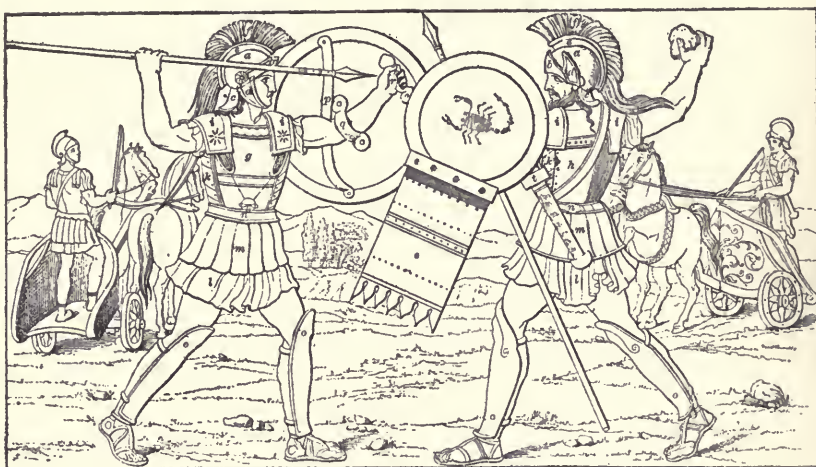

FIG. 76. — Two Greek warriors in full armor.

a, helmet; *b*, frontlet; *c*, neck-protector; *d*, cheek-protector (i.e., helmet with four protecting parts); *e*, helm-bow; *f*, helmet-ornament; *g*, breast-plate; *h*, back-plate; *i*, shoulder-pieces; *k*, connecting ribs; *l*, leathern undergarment; *m*, metal feathers attached to coat-of-mail; *n*, girth; *o*, greaves; *p*, shield-strap (in order to hang the shield over the shoulder); *q*, arm-band; *r*, handle of shield; *s*, shield-mantle; *t*, sword.

when, as in Laconia and Thessaly, a perfect adjustment and assimilation between the nobility and their subjects of alien race should prove impracticable. The patricians were thus in possession of the greatest riches, the highest culture, the best weapons, and the greatest military skill. They alone had the necessary experience in public affairs; they alone were acquainted with the principles of law and the administration of justice. They had finally a powerful support in the sanctuary at Delphi. An imposing priesthood did not stand in their way. Greek individualism prevented the priests from forming for themselves a pan-Hellenic close corporation. On the contrary, the

priestly families in the separate states considered themselves first of all noble families, and never developed an independent class. The patricians were to be overthrown only by the discords later developed among themselves.

Meanwhile the Greek world enjoyed a brilliant season under their leadership. Among the colonies of Asia Minor, where wealth, population, commerce, trade, and industry, extension of territory and of colonization, experienced a wonderful growth, it is only Ionian history that takes on definite outlines. Here the cultivation of epic poetry goes hand in hand with material prosperity. The patricians, who had, in the second half of the eighth century B.C., everywhere in Ionian territory overthrown the monarchy,—in Miletus and Samos by open violence,—defended their cities with a strong hand by sea and land. The neighboring Lydians, under the dynasty of the Heraclidae or Sandonidae (1194–689 B.C.), though, indeed, not formidable foes, forced the Greeks to keep always in training for war; thus the cavalry of Colophon especially won great renown. The wild Cimmerians were, however, not easily repelled, when, coming from the direction of the Halys in 695 B.C., they overran Phrygia, laid waste Sardis, and even approached the Ionian coast. The Aeolian Antandros fell at that time into the hands of the barbarians, and the hoplites of Magnesia on the Maeander met frightful reverses. But the youthful vigor of the Greeks easily recovered from such blows. Unfortunately, however, the Ionians, on account of commercial envy or jealousy, did not hesitate to turn their arms against Greeks of other tribes, as well as against one another. They never developed any strong federal alliances. Even Miletus, the pearl of Ionia, the mightiest maritime city of all, the mother of many colonies, the centre of a flourishing trade and growing manufactures, attained to no supremacy over the communities of the same stock. The stubborn endurance, the abundant strength and skill, as well as the lamentable want of harmony of the Ionians became very manifest when, after 689 B.C., affairs in Lydia worked to the disadvantage of the Hellenes. Here for the first time perceptible hindrances opposed the extension of Greek civilization. In the year 689 B.C. King Candaules, the last Sandonide, was overthrown by Gyges, the captain of his guard. The new king and his house, the Mermadae, made the Lydians a strong military folk. This new far-seeing dynasty was unwilling, too, to leave the magnificent coasts of their country longer in foreign hands. Thus began with Gyges the tedious wars against the Greek maritime cities, which first he (689–653 B.C.), then his son Ardys (653–617 B.C.), prose-

cuted with unremitting rigor. Notwithstanding these external dangers, the Greeks made considerable progress in the work of colonization and in art and science. Their walls were defended with the greatest bravery, and usually with success, since the sea was always open to them. Gyges succeeded in conquering only Magnesia, near Sipylus, and in forcing Colophon to enter into an alliance with him. His arms proved unavailing against Miletus and Smyrna, and after a twenty years' struggle, complications elsewhere caused Gyges to leave the Greeks again in peace. Evil times came again under the Lydian king Ardys. About 630 B.C. there was another terrible, though transitory irruption of the Cimmerians, who, under the lead of Lygdamis, destroyed not only Sardis, but even Magnesia on the Maeander, and then also the temple of Artemis at Ephesus (Fig. 77).

The Siceliotes and Italiotes also enjoyed, during the time of the rule of the nobles, a brilliant period of development. Here, too, a detailed



FIG. 77. — Late Coin showing the Temple and Statue of Artemis at Ephesus.

historical account is quite impossible; but we know that this western wing of the Hellenic world attained very early to a high degree of material prosperity. In Sicily, Syracuse, Gela, and Agrigentum became most prominent. The weak Sichel tribes, which were able to hold out only in the mountains of the interior, were deprived of all their coast territories by the Hellenes, and then fell into a state of dependence. The Sicilian Greeks pursued agriculture and cattle-raising on a large scale. Commerce

was based especially on the export of agricultural products. Quite similar was the development of the Italiotes, whose prosperity was even greater; only here material interests dominated exclusively, and with the single exception of Croton there was slight trace of intellectual activity. The weak Sichel and Oenotrian shepherd tribes in southern Italy yielded to Greek arms and became dependent. In the modern Calabria, Croton and Sybaris especially rose to great power, becoming the mother-cities of numerous new Achaean colonies in lower Italy. By the sixth century B.C., the whole territory from the borders of Locri in the south to Metapontum and Posidonia in the north, with the valuable mountain forests, excellent pastures, and splendid orchards and vineyards, had come into the possession of the Greeks.

The lack of historical information concerning the Greek life of the colonies east and west during this period is matched by an equal

deficiency as to large portions of the mother-country. We know that in Thessaly patrician authority took deep root after the overthrow of the monarchy. Great families arose, exercising feudal sway, among which the most important was that of the Aleuadae of Larissa. A series of petty internecine and border wars and forays presents nothing worth transcribing.

In Boeotia the monarchy had disappeared by the middle of the eighth century B. C. The old inhabitants, so far as they remained in the land, were not reduced to bondage, but lived as subjects of the ruling class, without political rights, but free, on lands belonging to the several cities. The nobility of the eleven or fourteen largest municipal districts were very powerful in this mainly agricultural district, their members being excellently trained in arms and gymnastics, and their cavalry and hoplites were especially fine troops. The history of this region turned especially upon the efforts of the Thebans to win the supremacy in Boeotia, and to change the loose association of the allied towns into a firm federal unity, which was regularly opposed by the aristocracy of Orchomenus and the brave community of Plataea. In Thebes itself the Corinthian Philolaus was said to have arranged (about B.C. 725) for the nobility a new constitution, which aimed especially at the strict maintenance of aristocratic sentiment and the security of landed property.

Less closely united, but still none the less firmly rooted, was the aristocracy in Attica. Here, too, the monarchy had not been able to maintain itself. The old story, it is true, according to which after the death of Codrus (p. 60) the monarchy had been changed into a life-long archonship is in its current form quite untenable; since it is clear that Codrus was followed as king by his son Medon, and he by a number of other princes of the same dynasty. The history of Attica, however, during their authority remains a blank page, except that according to a recent conjecture the atonement for bloodshed, and the laws relating to homicide, were established through Delphic influence about 800 B.C. The ancient monarchy succumbed about the middle of the eighth century B.C. to the ambition of the numerous nobility, who had been materially strengthened by many fugitive patrician families. The nobility changed the office of the Codridae into a decennial elective monarchy. The Eupatrids (the 'well-born' or 'noble') claimed the right to choose from the descendants of Codrus a *prytanis*, or archon, who should be responsible to them, and stand for ten years at the head of the Attic government, being commander of the army, presiding officer of council and court, as well as performing the duties of priest.

With this revolution began Eupatrid authority in Attica, and continued till the last quarter of the seventh century B.C., without many occurrences of historical importance, so far as known. But during this period the Attic laws for homicide are more and more fully developed, while, on the other hand, the peculiar classification of the Attic state, which perhaps was not organized in detail till after the fall of the monarchy, clearly appears as the basis of the government. Of no special historical importance was the division of the Attic people into the three classes of Eupatrids, or patricians, *geomori* (lesser landed proprietors, farmers, and tenants), and *demiurgi* (the free country laborers, and artisans), with whom there was only a small number of slaves of different kinds. The ancient division into four phylae, or tribes, geographical in its basis perhaps, abolished by Theseus, may now have been revived and adopted by the Eupatrids. The Geleontes, in the original home of the tribe, the territory about the Cephissus and Ilissus; the Hopletes in the eastern part about Marathon, the Argadeis in the Eleusinian lowlands, finally the Aegicoreis in the mountain districts from Parnes to Sunium, were in historic times arranged into three subdivisions each, the so-called *phratriae*, or brotherhoods. Every phratría comprised thirty clans, the refugee nobles being included in these. Every clan, and indeed every phratría was connected, not only by common sacrifices and sanctuaries, but by the belief in their descent from a common ancestor. The head of the oldest patrician family in every clan was chief of that clan; the thirty clan presidents of each phratría chose the head of the phratría, the phratriarch, while the ninety clan presidents of each phyle chose together the phylarch.

This organization became in course of further development more and more important for the internal administration. In the first place the great council seems to have consisted of the four phylarchs and the three hundred and sixty heads of clans, who with the decennial archons attended to the affairs of government and the administration of justice. In trials for homicide, the most solemn forms were connected with the court on the Areopagus, opposite the Acropolis, which had jurisdiction over premeditated murder. The view seems quite probable that the further development of the system of phylae kept pace with the growing power of the Attic nobility. The Eupatrids did not long leave the exclusive right to the ten years' presidency to the old royal house. As early as 712 B.C. the highest office of state was opened to all the Attic patricians; and the princely dignity was forthwith bestowed upon Leocrates, who did not belong to the posterity of Codrus. But in

683–682 B.C. the Attic government was completely remodelled. From that time nine archons were chosen annually. There was a chief officer, the president of the republic, the Archon Eponymus, who gave name to the year, and with him eight others, perhaps two for each tribe. The chief business of state was divided among these. The archon eponymus presided in the senate and in the popular assembly, and had jurisdiction in penal cases, family rights, and laws of inheritance. The second archon, the *basileus*, or King Archon, performed the priestly functions of the former rulers, besides presiding in all processes involving religious questions, and especially (with the four heads of phylæ) in complaints for bloodshed. The third archon, the Polemarch, was the commander of the army, and directed also the military and foreign affairs. The remaining six, the so-called Thesmothetæ, had judicial authority, except in matters of religion and homicide and in family disputes.¹

To this time probably belong also various changes in the Attic government. It has been conjectured that the system of phylæ was now extended over the whole of the Attic people, and that the common people were adopted at the same time into the phylæ, and placed in the relation of clients to the patricians. According to this view the peasants, who doubtless had already long shared in the cults of the nobility, were assigned in small communities to the patricians, in such way that about the same number of peasant families belonged to each of the geographically separate phylæ. So the heads of clans became on the one hand patrons, on the other local magistrates, of the peasant

¹ In Aristotle's Athenian Constitution, which — though very well known to scholars of antiquity — was first rediscovered and published to the modern world in 1891, the origin and mutual relation of the several archons are thus explained:—

“Now the ancient constitution, as it existed before the time of Draco, was organized as follows. The magistrates were elected according to qualifications of birth and wealth. At first they governed for life, but subsequently for terms of ten years. The first magistrates, both in date and in importance, were the King, the Polemarch, and the Archon. The earliest of these offices was that of the King, which existed from the very beginning. To this was added, secondly, the office of Polemarch, on account of some of the kings being feeble in war; for which reason Ion was invited to accept the post on an occasion of pressing need. The last of these three offices was that of Archon, which most authorities state to have come into existence in the time of Medon. Others assign it to the time of Acastus [the successor of Medon]; . . . that it was the last of these magistracies to be created, is shown by the fact that the Archon has no part in the ancestral sacrifices, as the King and Archon have, but only in those of later origin. So it is only at a comparatively late date that the office of Archon has become of great importance by successive accretions of power. The Thesmothetæ were appointed many years afterwards, when these offices had already become annual; and the object of their creation was that they might record in writing all legal decisions, and act as guardians of them, with a view to executing judgment upon transgressors of the law.” (Kenyon's translation.)—ED.

population, the right of appeal to the thesmothetae being reserved. Attic citizenship seems to have depended upon membership in the clans and phratryae, which shared with one another the duty and the right of accusation for murder, had common burial-places, and right of mutual inheritance.

Corinth displayed great activity and energy during this period, especially as a commercial,¹ industrial, and artistic centre. The monarchy was in 745 B.C. replaced by an annual archonship, with a council of nobles. The archons were, however, chosen from the former royal house of the Bacchiadae. In Megara, which about 800 B.C. successfully revolted from Corinth, the kingly power was likewise overthrown by the nobility.

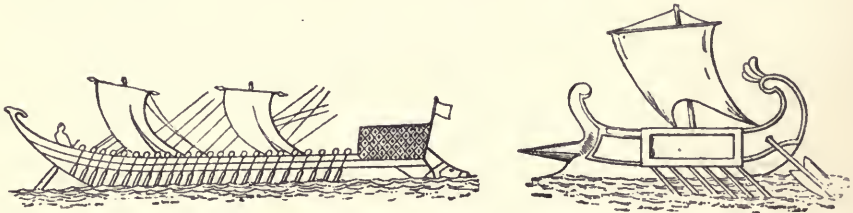

FIGS. 78, 79. — Two flat-boats each with one bank of oars: penteconter of Phoenician form, from a vase-painting; and a boat with beak, from a medal.

Meanwhile the southern part of the Peloponnese displayed growing power in military matters. Lycurgus's reform had not miscarried. The Dorian battalions of Sparta soon became formidable to their neighbors, first of all to the still unconquered Achaeans of the southern part of the valley of the Eurotas. After long and hard conflicts, King Telecles, about the year 800 B.C., conquered their strong fortress of Amyclae, and soon Pharis and Geronthrae were given up. The Spartans now extended their authority over the whole Eurotas valley, as far as the southern shore of Laconia; took Helos in 770, and left only the east coast to the Dorians of Argos. For a time, however, it seemed that Argos was going to anticipate the Spartans in the supremacy in the peninsula. The energetic Argive king, Phidon, the ablest of the Temenidae, succeeding to authority about 770 B.C., made an earnest effort for the supremacy of his state in the eastern part of the Peloponnese. He revived the decayed political federation of the Dorian communities of the east, and forced even Corinth (757) to furnish him troops. Besides, he was fully determined to get control of the Olympian games, whose importance did not escape him. He suc-

¹ Illustrations of Greek ships are given in Figs. 78-80.

ceeded as ally of the Pisans in repelling the Eleans, and, as descendant of the oldest branch of the Peloponnesian Heraclidae, conducted the festival on the Alpheus in brilliant fashion in 748 B.C. The imposing display of Phidon's power, which extended without opposition from Cythera to Corinth, from Aegina and Troezen to Phlius, left, in one respect at least, very perceptible and lasting traces. He was the first to adopt the system of weights, coins, and measures, which afterwards obtained in the greater part of the Hellenic states. He made the Babylonian-Phoenician system the basis of his own regulations. The Babylonian silver talent of $67\frac{1}{3}$ pounds was the unit of the Phidonian coinage. Following the example of the Babylonians and Phoenicians, he divided this talent (which in his system weighed 72 pounds) into

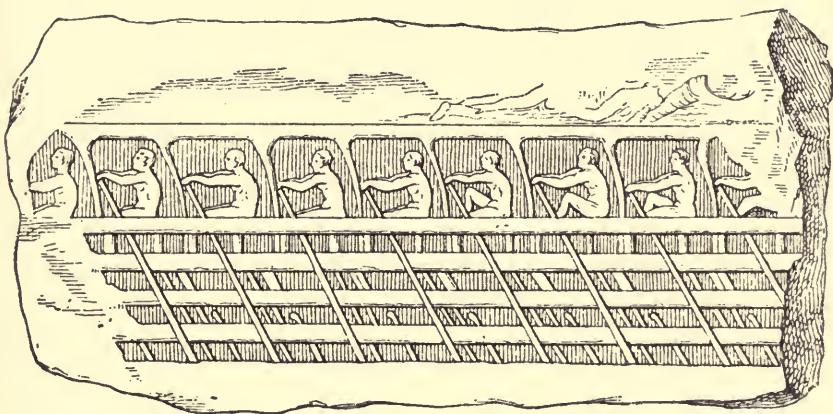

FIG. 80. — Fragment of the representation of an Attic trireme on a bas-relief.

60 parts, the Semitic name 'mina' being retained. The value of a mina was about \$30. Each mina was divided into 50 staters, each of these again into two drachmae, so that there were 6000 drachmae to the talent. The new money was coined partly in larger gold pieces, partly in smaller silver pieces. When later, in the course of the sixth century, the island of Aegina became a dominant naval and commercial power, the name of the Phidonian currency was supplanted by that of the Aeginetan.

But Phidon's political power did not last long. Whether he lost his life in a conflict with Corinth, 745 B.C., or yielded to the power of the combined Eleans and Spartans, who in 744 won back for Elis the Olympian festival, at any rate after his death the kingdom of Argos gradually lost its importance. The Argive league dissolved, and soon

even the immediate territory of Argos was abridged by the Spartans. The latter began now with increasing success their victorious expansion in the south of the Peloponnese. The method of distribution and inheritance of Dorian landed property in Laconia necessitated a speedy extension of Spartan territory, in order to secure suitable provision for the younger sons of Dorian families. The chief victim of these circumstances in the eighth century B.C. was the sister country, Messenia.

In this most charming of all the provinces of the Peloponnese, the attitude of the Dorians toward the old inhabitants was quite different from that in Laconia. In the coast towns the old population had maintained itself. In the heart of the province the Dorians, under the Heraclid branch that reigned at Stenyelarus, were indeed masters of the country, but a great part of the Dorian element was, not without the influence of their Arcadian neighbors, in process of open amalgamation with the older population, diligently engaged in agriculture, inclined to a life of ease, observing not only their own religious rites and ceremonies, but also those of their new home. Friction with the Spartans arose; the wealth of the Pamisus valley tempted the latter to seek here to supply their own need of increased territory. Besides, there appears to have been in Messenia a party which desired a connection with their Dorian kinsmen in Laconia.

Boundary disputes apparently caused at last the long suppressed hostility to burst forth in that tedious conflict known in history as the First Messenian War (according to later chronology about 735 B.C.). The Spartans began hostilities under their king, Alcámenes, by surprising and seizing the mountain town Amphea, which controlled the passes between Messenia and Arcadia, as well as the plain of Stenyelarus, and furnished an excellent base of operations for continual invasions of the Messenian territory. But the war, which was prosecuted mainly under the kings Theopompus and Polydorus, fell with unexpected severity also on the Spartans. When the hardy Messenians of King Euphaëus were no longer able to hold the field before the Spartans, the most vigorous elements collected together in the natural central fortress of the canton, on the majestic height of Ithome, situated on the dividing line between the upper and lower Pamisus valleys. Having an unobstructed slope to the north, east, and south, it was easy to fortify. Here they defended themselves after Euphaëus's death for many years under the command of the colossal Aristodemus, whose heroism recalls the fierce figures of old Greek legend. Not till after his death was the resistance of the Messenians

overcome (716 B.C.). Then recurred in Messenia a state of affairs which had not been known in Greece since the close of the period of migration. The most resolute Messenians left their country, the major part settling at Rhegium, in south Italy. The Spartans, however, who were soon afterwards compelled to rid themselves of a mass of discordant elements in their old territories, the so-called Parthenians, by colonizing them at Tarentum (707 B.C.), now took possession of all the Messenian territory except the western coast cities and the wild northern mountain district of Andania. This enabled them to make abundant provision for their younger sons and poorer citizens. The inhabitants of Messenia who remained sank into the condition of the Helots.

The Messenians did not remain quiet in this condition; but before they again tried their fortune against Sparta, the latter, among whom the royal power had been increased by the great military successes, had begun new wars of conquest against Arcadia as well as Argos. The feud was long and bitter, the fortune of war inconstant. A great victory of the Argives at Hysiae, 669 B.C., checked for a time the advance of the Spartans. Not till the middle of the seventh century did the Spartans acquire permanent possession of several Arcadian districts on the west, and on the east of the coast about Cape Malea, as far as Prasiae and beyond, together with the island of Cythera. It was only natural that Argos should zealously espouse the cause of the Messenians when they again rose against Sparta (645-631 B.C.).

In the third generation after the fall of Ithome, a young hero named Aristomenes headed the revolt of the free Messenians of Andania, who were joined immediately by the Messenians of the lowlands and of the coast cities. Besides, the Achaeans of Pisa, who after 672 (or 660) had again risen against Elis, as well as the Argives, and great multitudes of the Arcadian highlanders, took their side against Sparta. The uprising was so strong that all Messenia seemed lost to the Spartans, and even Laconia was seriously threatened. Not only was the latter in danger of an insurrection of the Helots and Perioeci, but also the Spartan land-owners who had been impoverished by the loss of their Messenian estates, now clamored impatiently for compensation, and that, too, in Laconia. In its perplexity the Spartan government, by the advice of the Delphic oracle, sought help from poetry. Peace and fresh courage were restored to the Spartans by one whom a later legend made an Athenian, the knightly bard Tyrtaeus from Aphidnae, whose songs, passionate and animated by genuine fire, ever afterward enjoyed

an immortal name in Greece. This new impulse to the Spartans, the treachery of an Arcadian chieftain, and the lassitude of their allies, finally proved fatal to the Messenians. The Messenian troops at last, no longer able to maintain themselves in the open field, withdrew to Mount Ira, which was situated in the wildest part of the mountains, near the southern border of Arcadia. From this point Aristomenes for some years boldly carried on a petty warfare with the Spartans, and by his bold predatory excursions gave his enemies no little trouble. Finally Spartan persistence prevailed. When at last they were sure of making a successful assault, and the Messenians had nothing to expect but certain destruction, Aristomenes with his brave band gave up the contest, and retired into Arcadia. Once more great multitudes of Messenians withdrew to Rhegium, and their country fell for several centuries under the undisputed rule of Sparta.

The military superiority of Sparta in the Peloponnese was now unquestioned, and so remained until the battle of Leuctra (371 B.C.). But the nature of Spartan success was such as still further to feed the cancer which had all along threatened her political power. The multitude of Helots was too large, the animosity of the Dorian bondmen in the valley of the Pamisus too bitter, and their situation too desperate, to admit of any hope of adjustment in this direction. For the present, indeed, the star of the Spartans was still in the ascendant; and they were for a long time able to put into the field nine or ten thousand hardy warriors of Dorian blood. Sparta was not yet the ruling power in the Peloponnese. This position it could only reach by crushing out a new political tendency, which, just then at its strongest, entered everywhere in Greece into open hostility with the rule of the aristocrats, and here in Sparta likewise with that of the Dorian race, the so-called Tyranny.



PLATE VI



Greek Artisans: Cobblers and Smiths.

Painting on an Athenian vase : about 500 B. C.

CHAPTER VI.

TYRANNY, TIMOCRACY, DEMOCRACY.

THE power of the patrician families in Greece could not long withstand the violent shocks to which it was subjected through increasing material progress and the accompanying concentration of the commonalty into large towns and cities. Just so soon as large portions of the people began to approximate the patricians in wealth, political intelligence, and knowledge of the world, there was an end of the old quiet submission to the authority of the upper classes, and agitations in behalf of higher political rights and privileges set in. The beginnings of the movement were everywhere of a similar nature. The Greeks never at any time attained absolute political and social equality, even apart from the fact that the demos itself rested on a substratum of slavery. When the opposition of the residents in cities, and, following that, of the peasants, began to manifest itself toward the patricians, the question was not of political equality in a broader sense. It was a long time before a real class feeling was developed in the populace, longer still before the democratic idea could be clearly and sharply recognized as a new political principle. Certain claims of the patricians gradually came to be considered arrogant and oppressive, and these the demos began to resist as soon as the signal was given at any conspicuous point in Greece. Democratic tendencies developed earliest and quickest in maritime and colonial states, where the many sided social development so early perceptible, extensive commercial intercourse, and great manufacturing activity (PLATE VI.¹), were unfavorable to patrician influence. Especially important was the fact that the power of ancient custom was lacking, and that the demos dwelt, as a rule, from the beginning, close together in the city.

¹ EXPLANATION OF PLATE VI.

This PLATE is copied from an Athenian vase painting which dates from the early part of the fifth century B.C.

The front side of the amphora ushers us into the shop of a shoemaker. In the centre stands a low table, with feet carved in the likeness of a lion's claws. On this is a white slab, half of the surface of which is made somewhat concave.

Upon this concave spot stands a woman, clad in sleeved chiton and himation; her

In the course of the democratic movement, most of the larger states of Greece became repeatedly theatres of wild revolutionary scenes. But the political results of the preliminary blows directed against the exclusive authority of the Eupatrids were different in different places. Very much depended in such cases on the bearing of the patricians. Occasionally fierce outbreaks of oligarchical arrogance, especially on the part of young noblemen, as well as brutal violations of female chastity, called for speedy and terrible outbursts of popular wrath. Nor were there wanting scenes in which the democratic movement took on for the time a communistic character. Often the patricians, as the old aristocratic spirit decayed, were weakened by discord among themselves, or degenerated into an oligarchy, conducting the government in the interest of their own class, and oppressing the commons. But even where all this was not the case, democratic opposition gradually became irresistible. The desire of the richer citizens for the right of inter-

hair is bound with a fillet. She faces the master shoemaker, an elderly, gray-bearded man, who wears thrown around his body a garment ornamented with dots of various sizes. He sits on a stool before her, and holds in his hand an implement such as tanners and shoemakers use to cut leather. He is on the point of cutting out a sole for the woman from the piece of leather on which she stands, using the foot itself as a pattern.

Opposite the master a younger man, an apprentice, is seated on a low stool. He holds in his left hand a piece of leather, perhaps to be fitted for use, as in making the upper part of the shoe.

The woman has not come to the workshop unattended. She is accompanied by an old man with white beard and hair, clad in a chiton, with a long staff leaning against his shoulder. He stands behind the apprentice, and indicates his participation in the proceeding by a gesture.

On the wall of the workshop are arranged various implements of the shoemaker's craft. On the shelf at the left we see a pair of tweezers, three awls, two of them upright, and a knife in the shape of a half-moon, with a handle. Beyond, two large pieces of leather are seen hanging from the wall; also two lasts, a basket, and two other objects the use of which is not accurately known.

Under the work-table is a large dish. Near this lies a pair of unfinished sandals.

The other side of the amphora represents a blacksmith's shop. The large black spot at the left indicates the cavity of the forge. In front of this stands the anvil, at which two men are working, both entirely naked because of the heat. The garment of one of them hangs on the wall. One of the smiths is a young, beardless man, whose hair is bound by a fillet. He holds a piece of iron on the anvil with a pair of tongs, and watchfully awaits the blow of the heavy hammer, which the other smith, a bearded man, has raised for the stroke.

Behind the smiths are seen two bearded men. They wear chitons that entirely cover the body, and have staves. One sits on a small anvil, the other on a low, cushioned stool. They are probably to be regarded as visitors; for the Athenians enjoyed frequenting the shops in the market-place and on the principal streets for gossip and conversation. Yet the man with the outstretched arm (and the same explanation may be applied to the figure making a similar gesture in the picture first described) may be considered the master of the shop, who directs his slaves at their work.

On the wall hang the implements of the trade, — three hammers, a wooden-handled knife, a saw, and a chisel, also a pitcher and a sword. At the foot of the anvil lie a hammer and a pair of tongs.

marriage with the Eupatrids, of the poorer classes for relief from debt, and political demands, either for the publication of the legal principles according to which the nobles administered justice, or for the positive extension of the rights of the people, everywhere claimed attention. The first attempts of the patricians to meet such movements were frequently very shrewdly devised. They sometimes adopted the first bold spokesman of the demos into the ranks of the nobility, showed a yielding spirit on points of intrinsically small importance; above all preferred to open the way to the opposition to found new colonies. But when such means no longer sufficed, and the demos began seriously to oppose the exclusive authority of the patricians, a very bad state of affairs resulted. The rule of the Eupatrids became harsh and deliberately oppressive; the administration of justice was perverted to political ends, while the commons became embittered, and were inclined to violence. And from the middle of the seventh century wild conflicts between nobles and commons characterized the history of a large part of the Greek world.

The patrician families, except in Thessaly and Boeotia, Elis, and Arcadia, notwithstanding the great moral and material resources at their command, could not long withstand the opposition. But permanent democratic constitutions, or even democratic conditions, were not yet possible. The Hellenes had first to go through several stages of political development; on the one hand through Timocracy, on the other through Tyranny.

Often either political sagacity induced the contending factions to come to an agreement, or the urgent pressure of foreign relations brought the nobility to make concessions to the better elements in the demos. It was in the colonial states where the census offered a basis for the first adjustment of this nature. Almost simultaneously, about the middle of the seventh century B.C., a tangible form was given to this 'timocratic' principle, the aristocracy of property, in the east, — first in Cyne and Colophon, — and in the west in Locri Epizephyrii, where Zaleucus drew up the first written constitution and legislation known to the Greeks, and about 640 in Catana, where the celebrated Charondas was the author of a like creation. The conventional 'thousand' wealthy landowning families of such states were to constitute henceforth the citizens in a narrower sense. A thousand representatives from this property-nobility formed the great council who managed the government. The invention of this new form of constitution was very welcome to a great portion of the colonial Greeks. It

offered an escape from the dangers of civil strife, made possible reconciliation between the upper ranks of the democracy and the patricians, and offered to diligence, persistence, and fortune the prospect of higher privileges. The new principle of property as the basis of political rights long maintained itself, under various modifications, in Greece. But for several generations only landed possessions, not movable property, were considered. Timocracy, however, could not, of course, permanently satisfy the Greeks. Wherever the transition from timocratic to democratic organizations did not gradually take place, the new citizenship petrified into an oligarchy, against which, in later times, the jealousy and the hatred of the poorer classes stormed with passionate fury.

Nor, indeed, did the cities which adopted timocratic constitutions avoid the necessity of passing through that peculiar phase, which resulted from the hostility between nobles and commons; that is, the Tyranny. The prospects of the demos, notwithstanding their greater number, were as a rule hopeless until they found leaders, — ‘demagogues,’ — who knew how to unite the masses in cities and country, and to oppose the superior dexterity and higher intelligence of the nobility with like weapons. Until the time of the successors of Alexander, these demagogues came, with few exceptions, from the ranks of the patricians themselves. They were sometimes noblemen, who for some reason or other had fallen out with their own class or were filled with a passion for power; sometimes men who were convinced of the necessity of a change of government; sometimes passionate natures who were only half-way entitled by birth to the rank of the ruling class, — but always highly gifted men who possessed great skill in winning the favor of the masses. If they succeeded in this, it was usually not difficult, with the help of the commons, or at the head of an armed band, to surprise the Acropolis, and overthrow the government of the patricians. The commons were still too immature politically to undertake the control of the state. The citizens, and still more the peasants, were quite content if they got relief from the yoke of the patricians and from debt, and had justice impartially administered to them. They were very willing to leave to their former leader the contest against a reaction of the patricians, the protection of their own interests, and so of necessity the full control of the government. Thus it happened that from the middle of the seventh century B.C. patrician demagogues in many parts of Greece usurped from the Eupatrids despotic authority.

So far as known, the first of these new rulers, or Tyrants as the

Greeks called them, appeared in the Peloponnese, where the new movement was connected with a reaction against Dorian supremacy. The uprising began in Sicyon. Orthagoras, a nobleman of the Ionic phyle of Aegialeans, who had heretofore had a share in the government with the three Dorian phylae, usurped, in 665 B.C., the supreme power from the Dorian nobility, which he then exercised with prudence and moderation. Ten years later the storm broke forth in Corinth, where the rule of the Bacchiadae had become oppressive and unpopular. The Corinthian demagogue was Cypselus, the son of the Bacchiad maiden Labda and the Lapithan Eëtion, who on account of his half-breed descent appeared as the champion of the non-Dorian families and of the demos. In the year 655 B.C. he slew, at the head of his faction, the hated and violent prytan, Patroclides, and then was himself hailed as sole ruler by the demos. The banishment of many Bacchiadae, the confiscation of their estates, and the restoration of the citizens who had been previously banished by the nobles, were the immediate results of the revolution. A good administration, and a prudent attention to the interests of the demos, made the new power of the tyrants of Corinth secure. But the new movement extended farther. In Epidaurus, Procles (640) established a tyranny, which was closely allied with the Corinthian; and beyond the Isthmus, in Megaris, a revolution occurred in which the opposition between peasants and nobility was especially sharply developed. Here Theagenes drove out the patricians, and established the tyranny, while a like attempt on the part of his son-in-law, Cylon, failed completely in Attica (before 620 B.C.).

There was sharp opposition between nobles and commons among the eastern Greeks also, especially in the chief Ionian city, Miletus, where, after the murder of King Laodamas, patrician prytans became the rule. Here the prytan Thrasybulus himself united with the powerful citizen class, and became tyrant, about 630 B.C. This prince, who immediately allied himself with Corinth, was aided by the necessity of repelling the renewed attacks of the Lydian Mermnadae, who from this time until about 615 B.C. were engaged in unavailing attempts to subjugate the Greek cities of Ionia.

At this time the authority of the Geomori ('peasant nobles') was still unshaken on the island of Samos, while in most of the Ionian cities toward the end of the seventh century the timocracy prevailed. On the other hand, Lesbian Mytilene had become a scene of wild confusion. Here, after repeated bloody revolutions and revolts, in which the poet Alcaeus and the gifted demagogue Pittacus largely figure (610

B.C.), supreme power came finally into the hands of the brutal tyrant, Myrsilus.

Thus arose in many parts of Greece new rulers, who played in many respects an important part in the development of Greek civilization. The tyranny of this period, which can by no means be compared with the cruel sway of the later tyrants of the time following Alexander, was in no sense a rude and unpopular despotism. Most of these princes, down to the time of Hiero and Gelon, were men of high intellectual endowment, who, having broken with the traditions and prejudices of their former associates, entered with clear vision and bold purpose upon new lines of life. Since the old glory of descent from the gods or from heroes of prehistoric times no longer was theirs, they sought to adorn their courts with the wealth and the magnificence of their own times. They welcomed poets to their courts, encouraged almost everywhere the arts and sciences then in their inception, and adorned their cities and castles with stately forms of architecture. Still, Tyranny could by nature and origin have only a transitory significance; and for various reasons it was fortunate that the political development of Greece did not end with it. Only in Corinth and Sicyon at the beginning, in Athens and Syracuse at the end, of this era in constitutional history did tyrants reign who were able to establish dynasties of any duration. This new form of authority meant for most of its wearers from the beginning nothing but splendid misery. The opposition of the fallen patricians continued irreconcilable. The result was a speedy demoralization of the Greek fibre; moral indifference occasionally ensued, even delight in murder for political purposes, besides an insecurity in the position of the tyrants, which sometimes drove these in turn to ugly deeds of violence. Mutual alliances among the tyrants, armed bodyguards, and a full treasury were almost universally their real supports. The second half of the sixth century B.C. shows everywhere, except in Sicily, the wicked selfishness of these princes, who at times seek for their insecure positions even the support of an alliance with Persia.

The manner in which the tyrants were overthrown was, so far as known, as various as the circumstances which called them forth. Often the nobles, sometimes alone, sometimes with outside help, especially that of the Spartans, succeeded in driving out or killing the tyrant. Then followed a long series of internal disturbances, even new tyrannies of short duration, until, finally, in some places a greatly modified patrician government, in others a still limited democracy, were established. Very seldom did either the simple old patrician rule or an organized democracy immediately take the place of the tyranny.

Surveying Greece from the east, we find the worst state of affairs in Miletus, where Thrasybulus seems to have died, or been deposed, about 610 B.C. After his reign the old patrician nobility coalesced with the rich burghers of the city, and formed a proud timocracy, or rather plutocracy, which stubbornly opposed the political aspirations of the lesser burghers, handicraftsmen, factory operatives, sailors, the lower classes (here called *Cheiromacha*, or *Gergithae*). The result was bloody internal feuds, fought out with horrible cruelty, by which Miletus was for several decades of the sixth century thrown into terrible disorder. The flower of the city perished, and thousands withdrew across the sea into old and new colonies. Finally (about 560 B.C.), in order to restore order, their kinsmen of the island of Paros were called in. Parian ambassadors drew up a new constitution, which set aside the claims of the plutocracy, as well of the radical democracy, and placed the balance of power in the hands of a more conservative element; that is, the land-owners of moderate wealth. But the depopulated city could not easily regain its ancient strength, although material prosperity returned after internal dissensions had ceased.

In Mytilene, after a long series of internal disturbances, the people, in 592 B.C., put supreme authority in the hands of Pittacus, who, having absolute power, not only defended the state against external foes, but sought also to secure lasting internal peace, unselfishly preferring to be only 'Aesymnete' of the city, not tyrant. Therefore he increased the constitutional rights of the commonalty, but did not deprive the nobles of the leading power. His chief work was the establishment of a comprehensive and excellent code of laws, which set aside the harsh aristocratic procedure and the arbitrary power of the judges. Property and personal rights were placed under the protection of legal enactments that were well considered, and drafted with deep practical experience. The courts established for the execution of these laws were essentially democratic in character. Finally he was able even to recall the exiles, and in 580 to lay down his office without reproach.

The dissensions in the Megarian state at this time are interesting, partly because of the connection with them of the poet Theognis, an aristocrat of the extremest type. He saw the impending ruin of his party, but was powerless to prevent it. The democratic and strongly communistic uprising of 525 B.C. brought for ten years heavy trials upon the rich patricians of Megaris. The rage of the commons vented itself in wholesale repudiation of debts, in expulsion of the land-owners, and in division of their estates among the proletariat. Finally the

whose multitude of the Megarian nobles who had fled to Sicily, Chalcis, and Sparta, united in the attempt to return home by force. The anarchy that prevailed in Megara made it not very difficult for the patri- cians to overcome the commons in the open field (about 515 B.C.); but the new government they established was forced to be much more moderate, and to make many concessions.

Affairs in Corinth and Sicyon had taken a different course. Cor- inth's most brilliant period was under the rule of the Cypselidae. Cypselus himself (655-625 B.C.), whose patronage of art at Olympia and Delphi has perpetuated his memory, developed vigorously and suc- cessfully trade and commerce, and established his state firmly among the Greek states. The loss of Corcyra was more than compensated by the founding of new colonies on the Ionian and Adriatic Seas. Espe- cially glorious was the rule of Cypselus's son Periander (625-585 B.C.), one of the ablest statesmen of his time. He first reduced Corcyra again to submission; then, by founding the colony of Apollonia on the Illyrian coast, and Potidaea on the Macedonian peninsula of Pallene, he secured new and important supports for the commerce of the Corin- thians. His political position was greatly strengthened by his alliance with Thrasybulus of Miletus, by his marriage with Melissa, daughter of prince Procles of Epidaurus, and lastly by his friendship with the Lydian king Alyattes, and the Egyptian Pharaoh Psammetichus. The naval power and the trade of Corinth continued to flourish under his reign. He was the first to conceive the plan of cutting through the Isthmus of Corinth. An intelligent patron of the plastic arts and of poetry, and a shrewd statesman often called upon to act as umpire for his contemporaries, Periander sought also to promote the interests of the peasants and their peculiar cults, especially that of Dionysus.¹ He covered the costs of his reign, without direct taxes, by custom-duties and market-fees alone, and in the year 587 B.C. developed the old local sac- rificial festival of Poseidon on the isthmus into the Panhellenic national celebration of the Isthmian games. Still he saw the future of his king- dom threatened, largely through his own fault, by unfortunate family troubles, which led to the war with Procles and the conquest of Epi- daurus. When he died, in 585 B.C., he was succeeded by his nephew Psammetichus, son of his brother Gorgus, prince of Ambracia. Cor- cyra fell to the lot of a younger Periander, second son of Gorgus.

¹ In PLATE VII. is given a view of the "Old Temple" at Corinth, which the excava- tions of the American School of Classical Studies at Athens, carried on since 1896, have proved to be the temple of Apollo. In the background is Acrocorinthus, the citadel of Corinth. — ED.



Ruins of the Temple of Apollo at Corinth. Acrocorinthus in the background.

(From a photograph.)

History of All Nations, Vol. III., page 118.

In this same period the tyranny in Sicyon reached its culmination under Clisthenes (probably 596–565 B.C.), a very energetic and successful ruler, especially noteworthy for his opposition to Dorian influence, and the systematic favor which he showed to the old Ionian part of the population of Sicyon. Thus he renamed the phylae, or tribes of Sicyon, bestowing upon the phyle Aegialea, which included the ancient non-Dorian inhabitants, the name of Archelai ('ruling class'); while the Dorian tribes received, in place of their renowned ancient names, — Hylleans, Dymanes, and Pamphylians, — the derisive appellations Hyatae ('swine-folk,') Choereatae ('porkers'), and Oneatae ('ass-folk'). This policy no doubt helped to increase the hostility of Sparta to the already tottering power of the tyrants.

CHAPTER VII.

SPARTA AND ATHENS IN THE SIXTH CENTURY B.C.

THE danger with which the tyranny and the democratic spirit of the north threatened the power of the Spartans, built as it was on a slight foundation and held together only by force, led, at the beginning of the sixth century, to a revival of the aristocratic spirit, and to a strengthening of Dorian institutions in Laconia. Recent investigation probably rightly ascribes the principal part in these new arrangements to a great statesman, Chilon, son of Demagetus, whom the Greeks reckoned among the Seven Wise Men of this century. He was the perfect type of the Spartan ideal of his time, and lived probably between 640 and 552; the regulations ascribed to him had for their object the preservation of the exclusiveness, the severity of military discipline, the undisputed superiority of the Spartans over their neighbors, and the sure submission of their subjects. From the beginning of the sixth century B.C. the Spartans, it seems, isolated themselves as completely as possible, in time of peace, from the outer world; forbade strangers to settle in Sparta, or their own citizens to settle elsewhere, and even made journeys abroad dependent on the consent of the authorities. They clung to the old inconvenient iron coins, which, weighing $1\frac{1}{2}$ pounds, were valued at about two cents, and were suited only to petty trade. The possession of gold and silver, and the use of costly apparel, were forbidden. Only in war did the Spartans exchange their coarse, sleeveless tunics, and their mantles of undyed sheep's wool, for purple uniforms. The education of robust boys — weakly children were exposed immediately after birth — was left entirely to the state. It began with the seventh year, and was under the control of the so-called *paedonomi* and five under-overseers, the so-called *bidiaei*. Divided into small troops, or *ilae*, which were combined into so-called *buae*, the Spartan youth were educated at the expense of the state in a number of large training-houses, and were schooled to obedience and severe privation, always with the predominant idea of being fitted for future service in arms. Gymnastic and orchestric exercises, musical training, the

songs of Tyrtaeus, Aleman, and Terpander, sung in the manly Dorian key, were the chief elements of the 'Lycurgean' training. The youths were to acquire from intercourse with men exercise of judgment, close observation, practical knowledge, and, lastly, the habit of expressing their thoughts concisely, strikingly, wittily, and with epigrammatic sharpness. Training in arms began in the eighteenth year, service in the army in the twentieth. The period of active military service was from 20 to 45. The men from 45 to 60 performed garrison duty at home. The public training of young men was not considered ended till the thirtieth year. During these last ten years they were continually occupied with bodily exercises; went on bold hunting expeditions in the high mountains, and, when this period was ended, joined one of the tent-clubs attached to the *syssitia*. From the best of these youths, or *eirenes*, was taken the troop of three hundred knights, 100 of whom formed the body-guard of each of the kings. Another of their duties is less pleasing to contemplate. The dangerous position of the Spartans, who, numbering only about 40,000 souls, were surrounded not only by the comparatively well-treated 150,000 to 200,000 Perioeci, but by probably nearly 500,000 Helots, led to fearful precautionary measures. The infamous *crypteia*, a system of espionage which was practised every winter at the command of the authorities by several hundred Spartan youths, in order to find out the disposition of the Helots, and to assassinate dangerous characters among them, formed a preparatory training for real war.

The political control of these well-disciplined forces was, after 580-570 B.C., no longer left in the hands of the Kings and the Gerontes, whose election had at that time been transferred to the popular assembly of the Spartans. It belonged to another body, whose full importance now begins. These were the five Ephors. This office was probably created during the first Messenian war by King Theopompus. But there was a vast difference between the ephors of the earlier time, who were appointed by the kings, and served partly as deputies in civil processes, partly as a city police commission, and those of the sixth century and later. It appears that after the second Messenian War the Dorian patricians had usurped the annual appointment of the ephors. According to a probable conjecture, the anti-monarchical movement in Sparta (about 580-570 B.C.) developed this office into a commission which was to hedge around the monarchy in every way, and make it impossible for the kings to overthrow the supremacy of the aristocracy. It was an organized opposition-government to watch

the kings, and with the right to bring them to account, to suspend them, and to accuse them before the Gerusia. The office steadily grew in importance; for the arbitrary power of the ephors was limited only by the condition that the whole five must be in favor of every decree, and that they were accountable to their own successors. Provided now with disciplinary power over the lower officials, and supported in time of peace by the 300 'knights,' managers of the public treasury, intrusted with the oversight of the Perioeci, and, finally, guardians of the education and public training of the youth, these ephors gradually became the real rulers of the land. They even acquired the right to summon the Gerusia and the Popular Assembly. Their influence extended to the foreign policy and conduct of war, especially as it became their duty to levy, arm, and determine the number of the troops.

With such means the Spartans were able to maintain their despotism for centuries. Marriage, the family, education, were made public institutions, and the strongest passions were subjected to an iron discipline. But all organic life in their commonwealth was crushed out. All activity in Dorian society centred in the opposition between the kings and the oligarchy, which under the lead of the ephors sought more and more to absorb the prerogatives of the crown. Evil results followed. The non-Dorian elements, the Perioeci hardly excepted, were, on account of the hopelessness of their condition, always disposed to revolution. And their discipline did not even suffice to protect the Spartans from demoralization so soon as other temptations presented themselves than those which the Peloponnese offered. Spartan activity, however, was able to cut the roots of tyranny in all the countries as far as Thermopylae, and to give to the Dorians of Laconia the supremacy in the Peloponnese.

The weapons of Sparta were, after the time of the second Messenian war, directed especially against Arcadia. And though they were long held in check here by Tegea, the growing power of the Spartan aristocracy restored to the Dorian-aristocratic elements in the north such confidence that the latter felt encouraged to attempt a reaction, supported partly by Spartan diplomacy, partly by Spartan arms. Such was the case especially in Corinth and her colonies. In Corinth the tyrant Psammetichus was deposed and slain by the patricians in 581 B.C. The tyranny in Corcyra and Ambracia became powerless. Aegina took advantage of the fall of Psammetichus to establish a wholly independent commonwealth, which grew to be of great importance for Doric civilization. Always excellent seamen, the energetic Aeginetans

soon obtained power and wealth. After the decay of the Ionian power in Asia, during the second half of the sixth century B.C., the Aeginetans were long dominant in the Aegean Sea. Their naval forces were almost equal in importance to the Corinthian, their trade and industries grew with astonishing rapidity, and even plastic art found there a sanctuary. In their foreign relations the Aeginetans were closely attached to Sparta.

Sparta naturally became the stay also of the restored patrician rule in Corinth. But as the nobility of this city afterwards treated the commons with great consideration, and prudently and zealously encouraged the maritime and commercial interests of the state, the close alliance with Sparta by no means led the Corinthians to follow blindly that city's foreign policy. Down to the time of the Persian wars we repeatedly find the representatives of Corinth in the Peloponnesian council, which met at Sparta, as spokesmen of a very decided opposition. The tyrannies in Sicyon and other states were one by one overthrown by the diplomacy and arms of the Spartans. Successful in a new war against Argos, they permanently annexed the province Cynuria, including the territory of Thyrea (about 565 B.C.). The attempt of the Argives in 549-548 to recover this valuable territory led to their defeat. When, between 580 and 570, the old feud between Elis and Pisa again took a dangerous form, the Spartans went to the aid of the Eleans, who were hard pressed by the Pisans and Triphylians. Pisa was now forever destroyed, and Triphylia, as far as the Neda, brought under the supremacy of the Eleans. The latter celebrated their victory by beginning at Olympia, about 550 B.C., a splendid temple of Zeus, which was completed a century later (Fig. 65). The Spartans now attempted to pursue their conquests on Arcadian soil. A mighty effort against Tegea (about 560) failed completely. Only when by the advice of the Delphic oracle a gigantic skeleton, reputed to be that of the Pelopide Orestes, had been secretly removed from Tegea, and solemnly buried in Sparta, was the contest renewed with spirit, and were the kings Anaxandridas and Ariston enabled, about 555, to end the war by an acceptable treaty of peace.

The persistent and stubborn resistance of the Tegeans showed the Spartans the impossibility of bringing the Peloponnesians under their authority by mere force of arms. This policy they now abandoned, and adopted another course, which created an epoch in Greek history. They set to work to unite the cantons of the Peloponnesians, not in a loose political and religious federation, but in a firmly established

league, in which Sparta was to have the diplomatic and military leadership. The treaty of peace with Tegea was the first step in this new direction. Sparta concluded with the Tegeans an offensive and defensive alliance, by which actual dependence was concealed under fair forms. The condition that the Tegeans were "never to call one of their fellow-citizens to account for friendly relations to Sparta" was characteristic. The new league made rapid and important progress. The remaining districts of Arcadia, as well as Corinth, which brought a naval armament to the alliance, joined it immediately. As early as 550 B.C. Sparta was considered the most powerful state of Greece. The severe defeat of the Argives in the war of 549-548 B.C. so shattered the power of Argos that her old allied cities, including Mycenae and Tiryns, went over to Sparta, and only some unimportant towns still held to the mother city. Argos, indeed, could never be won over to the alliance, nor could the Achaeans of the northern coast. But all the rest of the Peloponnese, with its outlying possessions, was about the end of the sixth century B.C. grouped around Sparta.

The Peloponnese thus exhibited from this time onward a compact and well-organized federal alliance. It is the first time that this phenomenon appears in Hellenic history. The alliance could without great effort put into the field an army of 40,000 heavy-armed men (hoplites), and three times as many light-armed troops. The command and disposition of this very respectable force was in the hands of the Spartans. The firm support of all aristocratic and conservative interests and parties, Sparta, without exactly interfering with the internal affairs of the allied states, was in all questions of military and foreign policy the controlling power of the peninsula. It was agreed what contingents in troops and ships of war the allied cities should furnish. In every case Sparta determined the strength of the levy and the amount of money required, furnished the commander-in-chief of the allied army, and appointed from among her own officers the leaders of the various federal contingents. In theory the foreign policy depended on the decrees of the assembly of representatives of the allies, which was to be summoned in such cases to meet at Sparta. Here each state had an equal vote; and the will of the majority bound the rest, except in religious matters. In practice, however, the matter took quite a different shape. In the first place Sparta was, as a rule, through her influence over the many smaller communities, sure of a majority. Further, without her consent no war could be voted by the league. Sparta could not be forced against her will to take part in a war

demanding by the majority, nor could she even be compelled by decisions of the majority to give up a war which the rest disapproved. In this case, of course, she had to depend entirely on her own resources; nor could she prevent the allied troops from leaving camp and going home, if, without summoning the federal assembly, she had issued a call for troops, and engaged in an enterprise which the chief of the allied states afterwards disapproved. Still, the new principle of the political and military hegemony had, in the hands of the Spartans, now for the first time taken shape on Greek soil. In the last decade of the sixth century it seemed altogether probable that Sparta would become the principal power of all Greece. Then occurred, however, unexpectedly on Attic soil a turn in affairs which within a surprisingly short time made the hitherto comparatively unimportant city of Cecrops a new Ionian power in Europe, the rallying-point of all sound democratic elements in the Greek world.

The history of Attica, from the complete establishment of Eupatrid authority in the year 683 B.C., shows a vigorous development. In this state also, though the patricians and the commons were of the same blood, discord had sprung up between the two elements in the course of the seventh century. It seems that the Eupatrids were forced by the growth in power of the neighboring states of Euboea, Corinth, and Megaris, to reorganize their forces, to provide the necessary hoplites and cavalrymen, as well as a number of ships of war. This led, it is commonly supposed, to a new arrangement of the phylae. Every phyle was divided into twelve districts; and each of these forty-eight districts (*naucrariae*) had to provide, besides its proportion of infantry and cavalry, the means to equip and maintain a war-ship. The magistrates of the *naucrariae*, who were appointed annually by the Eupatrids, formed from this time, as opposed to the great council of patricians which assembled only for important business, the lesser council of *naucrari*, which with the archons and the chiefs of the phylae managed the business of the government. The new arrangement pressed hard upon the commons from the fact that now the masses, as well as the patricians, were enlisted for both infantry and naval service. Attica seems at this time to have had about 10,000 men capable of bearing arms. The burdens of military service fell heavy upon the peasant population, who with a soil only moderately productive could with difficulty keep body and soul together. A bad harvest, even absence on a long campaign, easily sufficed to bring the poorer citizens into great straits. Under such circumstances there gradually developed in Attica a state of



Helen.

Menelaus.



Thetis.

Achilles.

Eos (mother of Memnon).

Memnon.

FIGS. 81, 82. — Archaic black-figured vase-painting in Royal Museum, Berlin. 1. The Recovery of Helen at the Capture of Troy. 2. Battle between Achilles and Memnon.

great economical distress. If money was borrowed from the patricians, the rate of interest then customary, and the rapid increase of the burden of debt resulting from compounding interest, reduced not a few peasant families to a state of real bondage to their creditors. The severity of the debtor's law caused numerous estates of impoverished small land-owners to fall into the hands of the patricians, and the proprietors to sink into the condition of hired laborers. Often when the peasant retained his land, he really only managed it for his creditor, to whom he paid an enormous rent.¹

In such a state of affairs an opposition developed which had its centre and support in the burgher class, that grew up first at the southern, then also at the northern, base of the Acropolis of Athens. The people insisted especially upon knowing the principles by which the Eupatrids were guided in the administration of justice. They thought that if these were written down there would be an end of the dreaded arbitrariness of the patricians. The pressure of public sentiment was so strong that the Eupatrids yielded, and intrusted Draco, about 621-20 B.C., with the codification of Attic jurisprudence. It was soon manifest, however, that the chosen instrument of the patricians was bent upon turning the laws into iron fetters for the aspiring spirit of the commons. The only part of his work that was undisputed was his arrangement of the laws pertaining to the shedding of blood, and to the method of procedure in such cases. This part remained in force in Athens until after the end of the fourth century B.C. For all cases of bloodshed, Draco appointed, with the King Archon and the chiefs of the phylae, fifty-one worthy men over fifty years of age, the Ephetae, who were to serve for life. But the parts of the Draconian code which had reference to the ordinary matters of penal law caused deep and well-deserved resentment on the part of the commons: The old vigorous common law had by this fundamental revision lost all local mitigating features. Draco had expressly emphasized the element of severity, made a very liberal use of the death penalty, even attaching it to theft of vegetables and fruits. The laws of debt, too, were strengthened by the provision that debtors who could not pay did not simply become servants of their creditors, but were declared slaves of them, and accordingly could even be sold abroad.

Resentment at the conditions that led to this legislation seemed to make the commons in Attica ready for a tyrant. The Attic nobleman, Cylon, son-in-law of Theagenes of Megara, who before 620 B.C. had

¹ Figs. 81, 82 are from a vase painted in Athens early in the sixth century.

seized the Acropolis, failed only because he had not made efficient political preparation, and because he had availed himself of the help of Megarian troops. The Attic people saw in his attempt only a wanton breach of peace on the part of the Megarians, and willingly followed the archon of the year, Megacles, of the great house of the Alcmeonidae, when he called out the knights and the peasants against the traitor. Cylon escaped in time, but his followers and the Megarian mercenaries were after a time forced by lack of provisions to surrender on condition of being allowed to withdraw from the Acropolis unmolested. But Megacles and his followers violated the sworn agreement, and butchered the Cylonians and Megarians as soon as they had left the Acropolis. Thus the guilt of a sacrilegious murder had been wantonly brought upon Athens, and the population became the prey of remorse and anxious fear of the vengeance of the gods. The new attempts of the patricians to win respect for their arms now failed lamentably. Theagenes of Megara, who immediately began a war of revenge upon Athens, won from the patricians the island of Salamis; and at last the Athenians adopted a decree threatening with death anyone who should again agitate the question of renewing the war for Salamis. Financial distress followed. The loss of Salamis, and the continual blockade of the west coast of Attica by the Megarian fleet, involved the merchants of the city, the fishermen and seamen, in great calamities. Whoever of the non-land-holding population was obliged to incur debts, borrowed 'on the security of his person;' that is, he ran the risk, in case he was not able to pay, of having first his children, and then himself, put into the class of slaves that could be sold. The commons became desperate; the condition of the country seemed almost hopeless.

But already the great man was found to whom it was appointed to rescue this noble branch of the Hellenic nation. Solon, son of Excestides, of the posterity of Codrus, born about 639 B.C., dear to the commons on account of the generous humanity which he, as a wealthy landed proprietor, had shown to his needy debtors, far surpassed the members of his class in purity and nobility of character, as well as in penetration and political capacity. Extensive travels and close observation had given him great experience and a wide political vision. A political genius of the first rank, a man of the purest patriotism, Solon was rightly incensed at the miserable Eupatrid government, and perfectly clear as to the inevitable consequences. The splendid misery of tyranny offered no attractions to his mind. He wished to be the saviour of his people in a different way. Protected by feigned madness

from the despicable law mentioned above, he roused — according to the story — the Athenians by a passionate elegy to renew the war for Salamis, collected five hundred volunteers from the commons, and wrested from the Megarians this important island. Thus he won such respect that he was able, during a dreadful pestilence, to induce the reluctant patricians to take steps to atone for the wanton murder of the followers of Cylon. The council of three hundred summoned for the purpose inflicted on the accused Attic officials of the year in which the crime was committed the mildest possible punishment, that is, banishment. Solon was now able, in order to make a thorough and general purification of Attic soil from the blood so wantonly spilt earlier, and to relieve the remorseful feelings of the Athenians, to summon to Athens the seer Epimenides of Cnossus in Crete (596 B.C.?).

Much was already won for Athens. But Solon saw clearly that there was no future for his country unless the people could be relieved of the financial burdens under which they groaned, and at the same time the ambition and avarice of the patricians could be checked. But it was difficult to find the right course. The mass of the people was full of rage against the wealthy landed nobility, the so-called *Pediæans* or men of the Plain. The desperate peasantry, especially the rude inhabitants of the hill country, the so-called *Diacrians*, men of the Mountains, looked for relief through some ruthless tyrant, who should repudiate debts, distribute estates, and expel the patricians. Among the nobility, there were only a few sensible men whom Solon knew to share his sentiments, and on whom he could count to assist in a moderate reform. The industrial, sea-faring, and trading middle-class of the city and west coast, the so-called *Paralians* or men of the Shore, were not numerous. With this grouping of social and political elements in Attica, it was inevitable that it, too, must pass through the transition period of a tyranny before coming to stable democratic forms. But it is due to Solon's patriotic unselfishness and political wisdom, that without violence an end was made of the bad state of affairs in Attica, this noble race saved from destruction, and a new political framework set up, within which the later party conflicts, down to the time of the Persian wars, could be enacted in a comparatively mild form.

The nobles, driven to desperation by the external difficulties of the state, at last determined to make concessions to the commons on the question of debts. Solon was therefore appointed (594 B.C.) as archon, with full power to act in this matter as peace-maker between the commons and the patricians, and to proclaim the laws necessary thereto.

Solon sought to accomplish his difficult task by a comprehensive system of ordinances, partly of a transitory, and partly of a permanent character. This system bears in Attic history the name of *Seisachthea*; that is, a general disburdening of the people. Solon's course required on the part of the creditors very considerable, but absolutely necessary sacrifices, without, however, favoring the radical demands of the *Diacrians*. All debts incurred by borrowing money "on the security of the person" were declared forfeited, all enslaved debtors were forthwith set free, and those who had been sold beyond the Attic border were brought back at the expense of the state. The prohibition ever again to pledge one's body as security for money borrowed, and the threat of the death-penalty against any who should in the future sell an Attic child or an Attic citizen into slavery, formed the transition to permanent measures. For the relief of those whose property was under mortgage, Solon introduced a new money standard. In the place of the *Aeginetan* standard, a system (current in the *Euboean* cities) based upon the light *Babylonian* talent of gold, which weighed $50\frac{1}{2}$ pounds, was adopted. The new so-called *Euboic* talent, about one-fourth lighter than the *Aeginetan*, was worth about \$1140, the *drachma* about 19 cents. With the introduction of this money standard, Solon decreed that existing debts should be paid off at the nominal value of the new coins. (In Figs. 83-111 are given illustrations of Greek coins.¹) This meant the remission of more than a fourth part of the

¹ EXPLANATION OF FIGS. 83-111.

Selection of Greek coins from the Beginnings of Coinage to the Time of Alexander the Great. After Friedländer and von Sallet. Originals in the Royal Cabinet of Coins at Berlin.

COINS OF HELLAS AND THE HELLENIC COLONIES.

The first stamping of coins was done, according to tradition, on the island of *Aegina*, whose silver coins have a figure only on one side; on the other, a *quadratum incusum*, — a sign of the greatest age. Accordingly, the types of the coins continue to be of the simplest form, indicating by some characteristic design, after the manner of coats of arms, the place of coinage; e.g., by the apple, *Melos*.

FIGS. 83, 84. — *Aegina*. Obv.: Sea-turtle. Rv.: *quadratum incusum*. These coins are often mentioned as *χελῶναί*. Silver.

FIG. 85. — *Island of Melos*. Apple (*μηλον*), play on the name of the island. Rv.: *quadratum incusum*, with three little rings. Silver.

FIG. 86. — *Corinth*. *Pegasus*, with the golden bridle which *Pallas* put on him for the conflict of *Bellerophon* with the *Chimaera*. Beneath, the letter *Koppa*, the ancient initial letter of the city, which became a sign. Silver.

With the advance in coinage, there appears in the *quadratum incusum* a picture or a superscription, and the indications of place of coinage become more perfect. Besides the usual animals, the front sides bear the patron deities of the cities in archaic form and animated attitude, often of elegant execution.

FIG. 87. — *Cnossus*. The *Minotaur* or bull-headed man. Rv.: the labyrinth as cross-shaped figure, made by meander lines, with a star in the centre. Silver.

FIG. 88. — *Athens*. A four-drachma piece. Silver.

debts. As a further relief, the rate of interest for all capital borrowed on real estate down to the year 594 B.C. was reduced. It was further ordained that no one should possess more than a certain amount of land. The remission of all still uncanceled fines and penalties, and of all outstanding liabilities to the state, in short, an amnesty from which only condemned murderers and those guilty of high treason were excluded, crowned Solon's work. Of course at first no one was satisfied; it was only a compromise. But soon the conviction of the excellence of Solon's work prevailed, the more as it was learned that he had allowed a very considerable amount of outstanding debts of his own to be forfeited. So that a general and hopeful trust in him soon returned in increased measure.

The people demanded, however, with renewed energy a reform of the constitution. Solon was strongly urged to hold his extraordinary power as tyrant. But though clearly understanding the difficulty of a

FIG. 89. — Thebes in Boeotia. Boeotian shield. Rv.: ΘΕΒΑΙΟΣ (Θηβαῖος) as designation. In the *quadratum incusum*, Heracles fastening the string on his bow; beside him his club. Silver.

FIG. 90. — Barca in Cyrenaica (Africa). Head of Zeus-Ammon, whose temple stood in the neighboring oasis; before it BAP. Rv.: the silphium plant, from whose juice a celebrated relish and healing remedy was made. Silver.

FROM THE FLOURISHING PERIOD OF GREEK ART.

FIG. 91. — Elis. Eagle with a serpent. Rv.: FA. Sitting Victory, a long palm-branch in the right hand. Silver.

FIG. 92. — Elis. Head of the Olympian Zeus, with a laurel wreath. Rv.: (F)A. A serpent erect before an eagle; in open space ΔΙ, which is the beginning of name of a magistrate. Silver.

FIG. 93. — Messene. Demeter, with a garland of ears of corn and an ear-ring. Rv.: ΜΕΣΣΑΝΙΩΝ. Zeus as worshipped on Mt. Ithome, naked, with the eagle, brandishing the thunderbolt; on the same mountain stood also the temple of Demeter. Silver.

FIG. 94. — Pheneus in Arcadia. Head of Demeter, with garland of ears of corn, ear-ring, and necklace. Rv.: ΦΕΝΕΩΝ; Hermes, with the boy Arcas on his arm, his head covered with the petasus; in his right hand the herald's staff. Arcas was son of Zeus and Callisto; after his mother's death, Zeus sent him to Maia to nurse. Silver.

FIG. 95. — Stymphalus in Arcadia. Head of Artemis, crowned with laurel, with ear-ring and necklace; the hair bound on top. Rv.: ΣΤΥΜΦΑΛΙΩΝ; Heracles striking with the club among the Stymphalian Birds (not represented); the lion's skin wrapped around his left arm, to protect it. ΣΟ: beginning of name of magistrate. Silver.

FIGS. 96 and 97. — Phaestus. Heracles contending with the Lernaean Hydra; he grasps its seven heads; the lion's skin hangs over his arm. The attendant of the Hydra, the great crab (placed by Hera among the signs of the heavens) seizes Heracles. Rv.: ΦΑΙΣΤΙΩΝ; the Cretan bull. (Phaestus, founder of the city of the same name, was a son of Heracles.) Silver.

FIG. 98. — Larissa in Thessaly. Head of Larissa, daughter of Pelasgus, with ear-ring necklace, and broad band around her flowing hair. Rv.: ΛΑΡΙΣΑΙ(ΩΝ). The four last letters in the exergue; a bridled horse. Silver.

FIG. 99. — Magnesia in Ionia. Cavalryman in armour; the arms covered, the feet in boots, the lance lowered, and mantle flowing; the horse is covered with a lion's



83, 84.



85.



86.

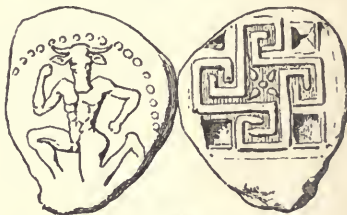

87.



88.



89.



90.



91.



92.



93.



94.



95.



96.



97.



98.



99.



100.

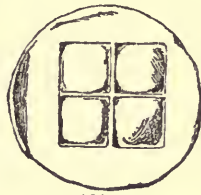

101.



102.



105.

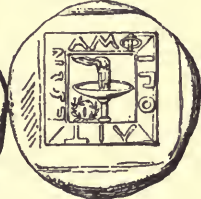

103.



104.



106.

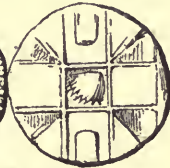

108.



109.



107.



110.



111.

compromise in constitutional matters, the great man clung to the determination of being personally unselfish. Finally the patricians yielded on this point also. When Solon had laid down his office, and the state had celebrated the accomplishment of the Seisachtheia by a solemn sacrifice, the great council of the Eupatridae appointed him by a new decree reviser of the constitution and lawgiver, with unlimited power to reject or retain, of the existing organization, whatever he might deem best.

For the present the old magistrates continued to perform their duties; but Solon devoted himself continuously, it seems, from 593 to 583 B.C., to his new constitution, with which a new and comprehensive code of laws was to be connected. In the spirit of the time he could

skin. Rv.: A butting bull; above ΜΑΝ; below ΔΙΟΠΕΙΘ. The whole surrounded by a winding ornamentation, which points to the situation of the city on the river Maeander. Silver.

MACEDONIAN COINS.

FIGS. 100 and 101. — Acanthus in Macedonia. Lion seizing a bull; in the exergue, the acanthus-flower and two round points. Rv.: *quadratum incusum* divided into four smaller ones. Silver.

FIGS. 102 and 103. — Neapolis in Macedonia. Head of the Gorgon, with outstretched tongue. Rv.: *quadratum incusum* divided into four parts. Silver.

FIG. 104. — Aenus in Thrace. Hermes with the petasus ornamented with a pearl band; the hair, in a braid, put around the head; the eye is seen, as on old Athenian coins, from the front. Rv.: in the *quadratum incusum*, ΑΙΝΙ; he-goat with long horns; below, a half-moon, with an ivy-leaf. Silver.

FIG. 105. — Amphipolis in Macedonia. Head of Apollo crowned with laurel; garment visible on the neck. Rv.: in a *quadratum incusum* a square formed of four raised borders; on the borders, ΑΜΦΙΠΟΛΙΤΕΩΝ; a burning hand-lamp; below, at the left, a wreath. Coined before the conquest by Philip II., 357 B.C. Silver.

COINS OF SICILY AND MAGNA GRAECIA.

These excel the coins of Greece proper, as well as those of Asia Minor, in beauty of design and perfect execution. The ten-drachma coins of Syracuse are the largest and most beautiful coins of antiquity.

FIG. 106. — Zancle. ΔΑΝΚΛΕ; beneath, a dolphin in a sickle. Zancle signified, in the original language of the island, a sickle, from the sickle-shaped tongue of land which forms the harbor. Rv.: flat *quadratum incusum* with many sub-divisions; in the centre a cony-fish. Silver.

FIG. 107. — Syracuse. ΣΤΡΑΚΟΣΙΩΝ. Female head crowned with laurel, with necklace and ear-ring, surrounded by a raised circular line; round about four dolphins. Rv.: a span of four horses, crowned by Nike; driver is beardless; in the exergue, a lion. Silver.

FIGS. 108 and 109. — Naxos (Sicily). Obv.: Head of Bacchus, bearded, with broad band, ornamented with ivy in the hair. Rv.: ΝΑΞΙΩΝ; sitting satyr, with long horse-tail, raises in his right hand a two-handled cup, and has a thyrsus-staff in his left; at the left an ivy-plant. Coined before the destruction of Naxos, about 403 B.C. Silver.

FIGS. 110 and 111. — Syracuse. ΣΤΡΑΚΟΣΙΩΝ. Female head, probably representing Persephone, with a wreath of ears of wheat, ear-rings, and necklace, surrounded by four dolphins. Rv.: four-horse team in rapid run; driver holds the goad, and is crowned by Nike, who hovers opposite him. In the exergue: the panoply (harness-greaves helmet, shield, and lance). Silver.

only make the forms of a timocracy the basis of an adjustment between nobility and commonalty. But it was his purpose to strengthen the democratic tendency implied in the timocracy. Besides, his ethical and practical feeling led him to elevate and strengthen the timocratic forms. The controlling idea in his reform was to grade the political rights, which were to be granted to the different groups of the Attic people, according to the duties and burdens which the state could claim from them on the basis of their property.

It is characteristic of the property relations of this period, and of the conservative tendency of this reform, that ownership of land was made the basis of this timocratic organization. The reformer arranged nobility and commonalty into four classes, according to the net income which each citizen received annually from his taxable property in land. The first class were the Pentacosimedimni, the possessors of estates which yielded annually more than 500 medimni (each of about $1\frac{1}{2}$ bushels) of corn, or an equal number of metretae (each of 33 quarts) of wine and oil. The second class were the Knights, the lesser land-owners, whose yearly income was more than 300 and less than 500 medimni or metretae. The third group was composed of the farming middle class, the so-called Zeugitae, who received each year an income of 150–300 medimni, or as many metretae, or this number of metretae and medimni combined. The petty farmers, whose income was less than 150 medimni, and whoever further had no land or movable property, belonged to the fourth class, the Thetes. Public burdens and political rights were graded according to this classification.

The heaviest burdens fell upon the members of the first class, who as trierarchs maintained the fleet, and had the expense and the honor of fitting out the choruses at the festivals of the gods. The knights, though liable to hoplite service also, served usually as cavalry. They had to maintain each a war-horse, and furnished in addition an attendant and a second horse. The first two classes seem at that time to have numbered together 2000 families. The Zeugitae, who formed the main body of the hoplites, furnished their usual heavy armor, besides taking each an attendant into the field with him. The people of the fourth class were relieved of all public burdens, and were called out as light-armed troops only in case of a hostile invasion. Regular direct taxes were not imposed. Only in exceptional cases did the state lay a tax upon the income of the citizens. The expenses of the government were defrayed from the income of state and temple lands, from the poll-tax of resident foreigners, and especially from customs-duties.

The public offices were mainly positions of honor, and military service was performed with slight compensation. Political rights were arranged to correspond to this system of public burdens. The archonships fell exclusively to the members of the first class, no longer by right of birth, but on the ground of heavier political burdens. The members of the second and third classes were admitted to the remaining magisterial offices, the Thetes being excluded entirely. Solon also reorganized the Council. This Boulé (as all democratic state councils in Greece were called, in opposition to the Gerusia) consisted of 400 men elected annually, one hundred from each phyle. Every man of thirty years, of the three upper classes, was eligible to the Boulé. This Council stood with the archons at the head of the government, and had also the management of the finances. In extension, further, of the rights of the mass of the people, all men of twenty years of the different phylae, without reference to the class divisions, could take part in the election of the members of the Boulé and the archons. The Ecclesia, which had been hitherto only the shadow of an assembly, now received new significance. It was to assemble four times a year, and with solemn forms and strict order of business engage in free discussion, besides having the final decision in all more important decrees of the Council, especially in regard to war and peace, alliances and treaties, new laws, and similar matters. (For illustrations of Athenian school-life about 500 B.C., see PLATE VIII.¹)

¹ EXPLANATION OF PLATE VIII.

Design upon a cylix, painted by Duris. Now in Berlin.

This picture is divided by the two handles. In the upper half, on the left, a youth is playing the double flute as a lesson to a boy, apparently about twelve years old, who stands before him. Above, on the wall, hang a roll tied up, a pair of tablets fastened together, and a lyre.

In the next group, another youthful teacher sits holding a tablet (*triptychon*) in his left and a stylus in his right hand, as though he were correcting a composition or exercise written by the boy who stands before him. Above, on the wall, is a cross-shaped object, and near it a fragment which seems to be part of a sack. On the extreme right a bearded man (the *paedagogus*, the slave who accompanied the children to and from school) is seated with his back to the teachers, but with head turned round to listen to the lesson.

In the lower half, at the left, is a bearded master, playing a seven-stringed lyre, face to face with his pupil, who follows him on a smaller lyre. On the wall are a drinking-cup (*cylix*), a lyre, and a basket.

In the centre a reading-lesson is going on. The master holds a roll half open and listens to a boy standing before him, who seems to be reciting what he has learned. The open part of the roll is inscribed MOISA MOI ΑΦΙ SKAMANΔΡΟΝ ΕΥΡΩΝ ΑΡΧΟΜΑΙ ΑΕΙΝΔΕΝ (*Μοῦσά μοι ἀμφὶ Σκάμανδρον εὐρρον· ἀρχομαὶ ἀεῖδειν*). Above hang a lyre and a flute-case (*συβήνη*) of lynx-skin.

To the right a bearded *paedagogus* sits watching the lesson. Above him is a drinking-cup.

The inner picture, which is badly damaged, represents a youth in a bath. He is obviously busied with the fastenings of his right sandal. Here, unfortunately, a large

PLATE VIII.





An Athenian School

Painting on a kylix, by Duris. (Royal Museum, Berlin.)

History of All Nations, Vol. III., page 156.

To the reform of the constitution was attached a new system of legislation, which extended to all relations of political and social life, and, in contrast to Draco's iron severity, was characterized by a certain humanity. Solon remodelled all of Draco's code except the laws relating to homicide. The burgher class, in the narrower sense, was zealously encouraged on the side of its material interests, and its industries fostered. In this sense, too, the class of *Metoeeci* (strangers, who, on payment of a poll-tax, lived under Attic protection) was favored, and admission to citizenship was made easier for artisans. Musical and gymnastic training was to be no longer the privilege of the sons of the patricians only, but of all citizens of the rejuvenated state. Especially were all citizens to be encouraged to active participation in public affairs. Solon placed a high value upon the right of Attic citizenship, the limitation or deprivation of which (sometimes even for a short time) was reckoned among the severest punishments of his code. Of his laws, one gave every Athenian the right of accusation in case of injury done to a citizen; while another required every one, on pain of disfranchisement, to choose his side whenever there was a sedition or civil discord.

The administration of justice was very considerably changed. Solon formed a supreme court from the commons itself, to which there was an appeal from the ordinary courts in all cases affecting life or limb, property, honor, or civil rights. The archons selected annually, by lot, from the mass of the citizens who had passed their thirtieth year, a thousand men. This assembly of sworn men constituted, under the direction of the *Thesmothetae*, the *Heliæa*, the members being called *Heliastæ*. Before this high court of appeals retiring officials could, at the expiration of their term of office, be prosecuted for transcending their powers or for misconduct.

The Athenians of later times always regarded Solon's constitution as the *Magna Charta* of their state, the first phase of their Democracy. And in fact the new constitution contained all the germs of the later democratic development of the state; though it must be remembered, of course, that in this, as in the other states of the Greek piece of the *cylix* is broken out and lost. On the part that still remains we can see one leg of a stool, on which the bather has placed his garment, and now rests his right foot. From the fragments of the left foot we see that he wore sandals. On the wall hangs a sponge; and behind the youth the bath-tub is visible, against which leans a long knotted stick, with a crook.

Around the inner picture is the artist's signature, ΔΟΠΙΣ ΕΛΡΑΦΣΕ (*Δούρις ἔγραψεν*), 'Duris painted (this vase).' The dedicatory inscription on the outer picture is ΗΙΠΠΟΔΑΜΑΣ ΚΑΛΟΣ (*Ἴπποδάμας καλός*), 'Hippodamas is beautiful.' The inscriptions on Duris's vases are mainly in the Old Attic alphabet. For another painting by him, see PLATE V. (p. 82).

world, the so-called "working-class" consisted of slaves who had no share whatever in public life. Solon himself did not at all wish that a preponderance of power should go over to the commonalty, which was still entirely lacking in political experience. A balance was secured by the functions and activity of the Areopagus, the highest and most venerable criminal court, which consisted of ex-archons who had served the state without blame. This high court, which had jurisdiction in cases of premeditated murder, arson, and treason, acquired now a new significance. Made up of elderly, and as Solon hoped, also tried, men from the most powerful, richest, and most independent of the great patrician families, the Areopagus exercised a free and irresponsible censorial power. It had the right to veto any measures of the Boulé and the Ecclesia that seemed to it not in accord with existing laws or the welfare of the state. Further, the Areopagus watched over religious worship, and, above all, over the moral conduct of the citizens. In this direction it devolved upon this body especially to denounce and punish crimes that were not reached by the law as such, and yet were felt by the public conscience and condemned by public opinion.

While Solon was accomplishing the laborious work of his reform, foreign relations had in many respects taken a more favorable turn. A war with Mytilene and the First Sacred War were brought to glorious conclusions. Only the feud with Megara smouldered on. The great lawgiver thought that the stability and the efficiency of his new creations must now be tested. He took, therefore, an oath from the patricians and the commons, that they would change nothing in the new constitution during the space of ten years, and betook himself for a period to travel.

Solon's hopes with regard to his work were only partly fulfilled, so far as his own lifetime was concerned. But one thing was certainly accomplished: with the renewal of internal tranquillity and the strengthening of the peasant class, the military spirit of the Athenians revived. The war with Megara, which was renewed about 580 B.C., resulted in considerable advantage to Athens. Among the young men of the highest nobility, Pisistratus, a kinsman and personal friend of Solon, began at that time to become prominent as a successful soldier. He was born about 605 or 600 B.C., of a family which traced its descent direct to the stock of Nestor, and reckoned itself among the proudest of the Pylian patricians. This young patrician, having got command of the Attic troops, by a bold stroke captured Nisaea, the harbor of Megara itself. Solon, who had lately returned from his

travels, seized the favorable opportunity to get Sparta to act as mediator, by which means a permanent peace was effected between Megara and the Athenians, Salamis being conceded forever to the latter.

As in England down to the age of Cobden and Bright, so in Athens under the new democracy, the nobility continued, until the opening years of the Peloponnesian war, to be the guiding force in public life. The influence of a tradition that was centuries old was necessarily very strong. As soon as the relief from domestic oppression had brought about more tolerable relations between nobles and commons, the influence of the patricians, who were connected by the ties of phyle and phratria in a thousand ways with the families of the commons, became again paramount. They continued for a long time still to control the elections. And even where the peasant or petty burgher was sensible of political oppression, he was often either too shy or too comfortable to insist upon his rights as ecclesiast and heliast. He drifted with the current of the time, and looked to a tyrant to fight his battle with the nobility. After the old exclusiveness of the Eupatridae had ceased, great factions had developed among them, which contended with one another for the supremacy in the commonwealth under the new constitution. The mass of the Pediaeans followed the lead of the old house of the Philaïdae, whose head at that time was Miltiades. The Alceonidae strove openly after the sovereignty. The younger Megacles, who had lately married the rich daughter of Clisthenes of Sicyon, was at their head, and their following in the demos consisted mainly of Parali. The young general Pisistratus worked quite independently, and steered with full consciousness toward the tyranny.

Solon's reputation postponed for some time the catastrophe which had been threatening since 565. But gradually the handsome, gifted, and popular Pisistratus, whose estate near Marathon lay in the immediate neighborhood of the settlements of the highlanders, who constituted the main body of the Diacrians, won paramount influence with the commons. About 560 B.C. Pisistratus got permission from the Ecclesia to keep a body-guard, and with these warriors seized the Acropolis. The commons were in hearty sympathy with this turn in affairs. Solon's opposition found no response. In regret at the apparent failure of his mission, Solon is said to have abandoned Athens, and after visiting Sardis, to have repaired to Cyprus, where — at the city of Soli — he died in the year B.C. 559.

Pisistratus did not come so quickly as he had doubtless hoped into quiet possession of the princely dignity. A part, indeed, of the

Eupatridae, under the leadership of the Philaïde Miltiades, withdrew and established, with the help of the sword, on the Thracian Chersonese, a new colony, of which Sestos became the central point. But this did not protect the tyrant, who was not inclined to secure his authority by violent measures, from the assaults of the rest of his antagonists. As early as 555 the Pediaeans under Lycurgus united with Megacles, and Pisistratus was obliged to leave Athens. Megacles, however, found himself after awhile reduced by the Pediaeans to such straits that in 550 he united with the exiled Pisistratus, gave him his daughter in

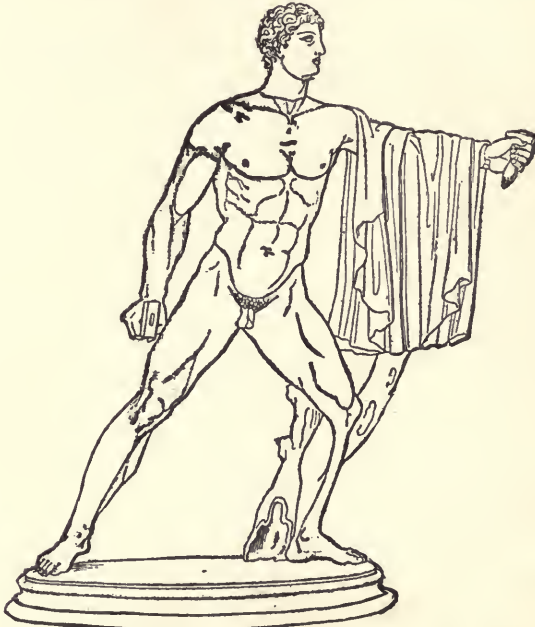

FIG. 112.¹—Statue of Aristogiton, the Tyrannicide. (Naples.)

marriage, and put the reins of government again into his hands. But when later these two again fell out, Pisistratus's position became a second time untenable, and he withdrew to Eretria.

Here, again, Pisistratus did not lose sight of the goal of his ambition; and as age gradually crept upon him, his son Hippias spurred

¹ The two figures of Aristogiton (Fig. 112) and Harmodius (Fig. 113) formed a group, and were placed side by side as if advancing to attack. In the original Aristogiton was represented as a bearded man. These statues were the work of Antenor, a sculptor of about 500 B.C. They were carried off by Xerxes, and were recovered many years later by Alexander or one of his successors. To replace them, Critius and Nesiotes made a group, which was probably the original from which the statues in Naples were ultimately copied. — ED.

him on again. At last the jealousy of the citizens of Eretria and of the patricians of Thebes against Athens offered him the means of enlisting mercenaries. Besides, money and a number of warriors were placed at his disposal by Lygdamis, the deposed tyrant of Naxos. Perhaps in the year 538 Pisistratus landed at Marathon, was joined there by the Diacrians and others of his party, marched then across Attica, and won, near the temple of Athena at Pallene, an easy victory over the poorly commanded militia of his opponents. Athens now opened her doors immediately, the Alcmeonidae and other great families left the country, and Pisistratus established himself permanently on the Acropolis as master of Attica.

This time Pisistratus sought to establish his authority more securely than before. All patrician families whom he could not trust were obliged to furnish hostages to him. He kept possession of the Acropolis, and retained as body-guard many of the mercenaries who had accompanied him. In order to pay these and meet other necessary expenses, he made the silver-mines at Laurium, in the southern part of Attica, crown property; and placed besides a tax upon the population, which is reckoned at about five per cent of the yearly income from the arable land. He forced, in 537 B.C., the patricians of Naxos to submit again to the tyranny of Lygdamis, made an alliance later with the powerful Polycrates of Samos, and established his son Hegesistratus as tyrant in the Attic colony of Sigeum. The internal policy of Pisistratus was advantageous to the people, and, on the whole, wise and sagacious. Great sums were expended on sacrifices and festivals, especially the Panathenaea, the great summer festival of the patron goddess of the land, Athena. Athens was adorned with handsome and useful public works. The famous Callirrhoë, the chief fountain of the old city, was walled in, and (now called Enneacrunus) discharged its

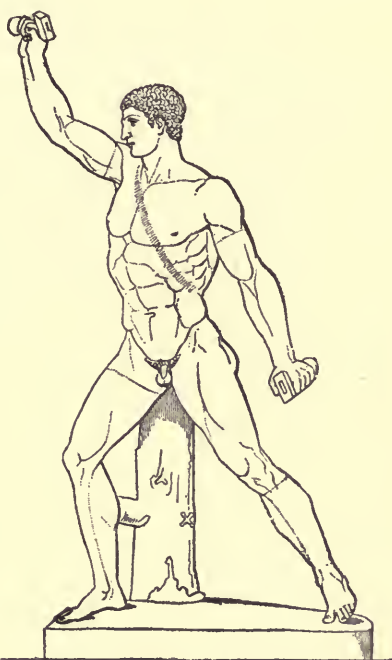

FIG. 113. — Statue of Harmodius, the Tyrannicide. (Naples.) See note on p. 132.

waters through nine pipes. On the Acropolis he built for Athena a splendid treasury and temple, the so-called Hecatompedon, and laid, southeast of the Acropolis, the foundation for that gigantic temple of the Olympian Zeus which was completed by the Emperor Hadrian in the second century A.D. Agriculture, trade, commerce, industry, were zealously encouraged under this ruler and his house. In this direction Solon's civil code was wisely extended. The greatest glory accrued, however, to the court of Athens from its encouragement of poetry, and its ornaments were the poets Simonides of Ceos (556-468 B.C.), and



FIG. 114. — Slaying of Hipparchus by Harmodius and Aristogiton. From a contemporary Athenian vase painting. (Würzburg.)

Anacreon of Teos. It was owing to the efforts of the Pisistratidae that now for the first time a recognized edition of the purified and established text of the whole of the Homeric epics, revised by eminent scholars, was offered to the nation. Pisistratus proposed to administer the government on the basis and under the forms of the constitution of Solon. The ruling house possessed, it is true, the power to enforce its will, even against the forms of the constitution, though this was to be avoided if possible. The laws of Solon remained intact, only care was taken that there should always be a member of the dynasty among the archons, and that, at least, the enemies of the prince

should not constitute a majority of the magistrates and senators. It was to the advantage of the commons that an end was made for many years to the quarrels of the patrician factions, and that the Athenians now came by long and quiet practice to see and revere in the ordinances of Solon the foundations of their own political life.

The sons of Pisistratus, Hippias and Hipparchus, ruled for a number of years after his death (527 B.C.) completely in his spirit. But in 523 Hippias aroused the deepest mistrust of the nobility. His father had come to terms with the Philaidæ; and Cimon, the brother of Miltiades, ruler of the Chersonese, had lived for several years in quiet possession of his estates in Attica. But Hippias, having entertained jealousy of Cimon, did not hesitate to have him murdered one night in the year 523. The displeasure of the patricians could no longer be overcome, and from this grew the catastrophe which led to the overthrow of the tyranny. A hostility, caused by very base motives, between Hipparchus and two young citizens, Harmodius and Aristogiton, resulted in these becoming the heads of a patrician conspiracy against the lives of the rulers. The plot came to an issue in July, 514, on the occasion of the great procession of the Panathenæa, which was to advance from the Ceramicus through the city up to the Erechtheum, the ancient temple of Athena on the Acropolis. Only Hipparchus fell a victim to the daggers of the murderers (Figs. 112–114).¹ The presence of mind of Hippias prevented an uproar. But the wild deed not only had suddenly disclosed to the prince the perpetual insecurity of the position of a tyrant, but it made him suspicious, and then harsh, violent, and even cruel. Even the commons began now to be painfully sensible of

¹ Aristotle, in his newly discovered Athenian Constitution, gives the following account of the subsequent events: "Of the two leaders, Harmodius was killed on the spot by the guards, while Aristogiton was arrested later, and perished after suffering long tortures. While under the torture he accused many persons who belonged to distinguished families, and were also personal friends of the tyrants. At first the government could find no clew to the conspiracy; for the current story [here Aristotle criticizes Thucydides], that Hippias made all who were taking part in the procession leave their arms, and then detected those who were carrying secret daggers, cannot be true; since at that time they did not bear arms in the processions, this being a custom instituted at a later period by the democracy. According to the story of the popular party, Aristogiton accused the friends of the tyrants with the deliberate intention that the latter might commit an impious act, and at the same time weaken themselves by putting to death innocent men who were their own friends; others say that he told no falsehood, but was betraying the actual accomplices. At last, when for all his efforts he could not obtain release by death, he promised to give further information against a number of other persons; and having induced Hippias to give him his hand to confirm his word, as soon as he had hold of it he reviled him for giving his hand to the murderer of his brother, till Hippias, in a frenzy of rage, lost control of himself, and drew out his dagger and despatched him" (Kenyon's translation). — ED.

his altered bearing. While the position of the Pisistratidae began thus to become insecure in Attica, the Alcmeonidae, their chief antagonists, prepared for a bold stroke from without. Their wealth, which was extraordinary for that time, made it possible for them to play even beyond the Attic borders a brilliant rôle, and especially to win the close friendship of the Delphic oracle. The temple of Apollo at Delphi had burned down in the year 548. The Amphictyones had raised a considerable sum for rebuilding; but the work could not begin because the 75 Aeginetan talents (\$135,000), which were to be furnished by the Delphians, had not yet been collected. Thereupon the Alcmeonidae undertook to rebuild the temple from their own means, and had the work constructed out of Parian marble (535-515 B.C.). The Alcmeonidae attempted in 513, at the head of the Attic exiles, an invasion of Attica, and fortified themselves at Lipsydrium, at the foot of Mt. Parnes; but they were completely defeated by the mercenaries of Hippias. The efforts of Clisthenes, their leader, son of Megacles and of the Sicyonian Agariste, to win the Spartans over to the cause of the Attic nobility, Hippias now frustrated by acknowledging the supremacy of Sparta. But the influence of the Alcmeonidae at Delphi was strong enough to induce the Pythia to command the Spartans "to free Athens from the tyrants." The ephors reluctantly gave up the connection with the court of Athens. The Spartan general, Anchimolius, took ship, in 510, for Attica, and besieged Phalerum, at that time the harbor of Athens; but he was badly defeated on the plain of Athens by the Thessalian cavalry, auxiliaries of Hippias, and lost his own life. Thus the military honor of the Spartans was so compromised that they were compelled under any circumstances to overthrow Hippias.

King Cleomenes I. led now, in the tenth year of his reign (510), a large army across the isthmus into Attica, and was joined by the Attic exiles. This time the Thessalian cavalry was badly beaten, and fled from the country; and the population everywhere rose against Hippias, who soon found himself blockaded in the well-provisioned Acropolis. This blockade might have been protracted for a very long time, had not the children of Hippias, in an attempt at escape, fallen into the hands of the besiegers. On condition that his family be released, and he be allowed to withdraw unmolested, Hippias capitulated, delivered the Acropolis to the Athenians, and withdrew to Sigeum, intending to win back his sovereignty by the help of the Persians.

The downfall of the tyranny only made room for the renewed hos-

tility of the great patrician families. Gradually the party of Isagoras got the upper hand, so that in the spring of 508 he was chosen archon. Then it was that his opponent, the Alcmeonide Clisthenes, the ablest Attic statesman of his time, gave an entirely new turn to the internal politics of this state. Clearly understanding the condition and elements of strength of the country, he determined to take resolutely the side of the commons, and to fashion the political fabric of Solon into a real democracy.

In order to break the excessive power of the patricians, the astute reformer determined to reorganize the fundamental principles of the government. The reform of Clisthenes which — expressly encouraged by the favor of the Delphic oracle — was really carried through council and assembly in 508 B.C., restricted the four ancient phylae, with their phratræ, essentially to religious matters, and to the management of the register for births, marriages, and deaths. Attica was now divided into ten new political districts, likewise called phylae, — Erechtheis, Aegæis, Pandionis, Leontis, Acamantis, Oeneis, Cecropis, Hippothoëntis, Aeantis, and Antiochis. Each of these phylae was made up of ten or more so-called demes, or ‘parishes.’ Clisthenes seems to have formed out of the little towns, boroughs, estates, villages, and hamlets then existing, the number of which is unknown, a hundred or more of these demes. Even the city of Athens, which had no exclusive municipal administration, was subdivided into several such districts. The demes, on membership in which citizenship depended (as before in the case of the phratræ) represented the lowest political unit for the new Attica. The demes were carefully organized; they elected their own demarchs, or chief magistrates, who took the place of the old naucrari, acted as local police, and had charge of the official list of the citizens. The demes had, further, their own local assemblies, in which the commercial magistrates were chosen, youths coming of age were admitted to citizenship, and the lists of citizens were revised.

Lastly the reformer shrewdly arranged that demes not contiguous but remote from each other should be united into a phyle. It is plain that, e.g., the knights of the Plain would be far from exercising the same influence on the peasants around Marathon or Sunium as heretofore on those families of the lower classes with which they had been for centuries closely connected by all possible ties. Another result of the new classification was the introduction of the decimal system into the whole organism of public life. The Boulé now consisted of five hundred councillors, fifty from each phyle. Each phyle had henceforth the

prytany or presidency of the Boulé for a tenth part of the year, and there were to be annually ten regular assemblies of the people. Thus the democratic tendency was by degrees considerably strengthened in Attic life. But it must not be forgotten, that, in spite of the growing importance of the mercantile and industrial class in Athens, the foundation of Attic democracy continued to be agricultural and conservative.

Isagoras and his friends were, of course, little pleased with these reforms. Isagoras himself, shortly before retiring from office in the spring of 507, induced his friend Cleomenes of Sparta to lead an army against the Athenian democracy. The Spartan army was preceded by a herald, who called upon the Athenians to expel 'the curse-laden' from the city. Clisthenes, who, as Alcmeonide and heir of the curse of the Cylonian outrage, was referred to, withdrew. As soon as Cleomenes had entered Athens, Isagoras and his most zealous adherents began a strong reaction under the protection of Spartan arms, compelled fully seven hundred Attic families, on account of their democratic proclivities, to leave the country, and formed thereupon an entirely new Boulé, a Gerusia of three hundred patrician representatives. Isagoras met, however, with stubborn resistance; the council, or senate, of five hundred did not obey his commands. And when Cleomenes garrisoned the Acropolis with his Spartans, the sight of foreign troops on the holy citadel of Athena, the protectress of the city, caused a general uprising in all Attica. The citadel held out only three days. Cleomenes ingloriously capitulated on condition that his soldiers should march out unmolested, and rescued of his Attic confederates only Isagoras. The Pediaeans, who had fled to him for refuge, were abandoned to the executioner.

Clisthenes and the rest of the exiles, who had been instantly recalled, had need now of all their military as well as moral strength; for King Cleomenes proposed, in revenge for his disgrace, to destroy Attica by an overwhelming coalition. The Hippobotae, the splendid chivalry of Chalcis, and the nobility of Thebes did not hesitate to join hands with the Spartans in a conflict against the Athenian commons. The danger with which the coming year seemed to threaten the Athenians led them to take a very questionable step. They sought help from Artaphernes, brother of Darius I., the Persian viceroy in Sardis. This ruler demanded, however, as the price of his help, their unconditional submission to Persian supremacy. In their perplexity the Attic ambassadors consented to this disgraceful condition. But when they had returned home, the honor and national pride of the Athenians prevailed;

and they declined to ratify such a treaty, trusting alone to a righteous cause and their own good swords. To the astonishment of the Greek world, fortune favored the people of Athens, and for the first time the significance of Athens for Hellas became evident.

In 506 B.C. the storm drew on. While the Chalcidian knights invaded Attica from the east, and the Thebans from the north, the Peloponnesian allied army, under the Spartan kings, Cleomenes and Demaratus, who had begun to reign in 510, appeared at Eleusis. But just as the Athenian army¹ was expecting a battle, it was surprised to see the great army of the Peloponnesians disband, and start homeward in detached bodies. The cause was this. The government of Sparta had called out the Peloponnesian army without a previous understanding with their allies. When the Corinthians, who were then well-disposed toward the Athenians, perceived the object of Cleomenes, they instantly marched home. When, now, King Demaratus also fell out with his colleague and left the camp, the whole army disbanded. The ephors, seeing an irreconcilable hostility spring up from this affair between the two kings, decreed that in future both rulers should never again enter the field with the same allied army. Meanwhile the Athenians, unexpectedly relieved from the direst necessity, threw themselves impetuously upon their other opponents. After a brilliant victory over the Thebans, who had sought in vain to reach the Chalcidian army, Clisthenes followed the retreating Chalcidians across the strait, defeated them, and pushed the war in Euboea with such success, that the Hipobotae were obliged to conclude peace on terms that forever put an end to their importance. Clisthenes divided the Athenian acquisitions in Euboea into about 4000 farms for the Zeugitae.

Athens had now shown herself in the eyes of the Greeks nearly equal to Sparta, but she was still in danger. The Spartans were not willing to recognize the Attic democracy, and in B.C. 503 proposed to the federal assembly in Sparta to restore by force the tyranny of Hippias. But the strong opposition of the Corinthian nobility induced the Peloponnesians to resist such proposals. Sparta kept quiet, though in bitter resentment against the Athenians, which only the mortal danger of the Persian invasion could overcome. The embittered Thebans, on the other hand, took care that another antagonist should allow the Athenians no rest. They induced the oligarchy of Aegina to begin a wearisome contest with Attica, which in the course of years became more and more bitter, and seriously injured the prosperity of both states.

¹ The hoplite part of the army was at this time about 7000 men.

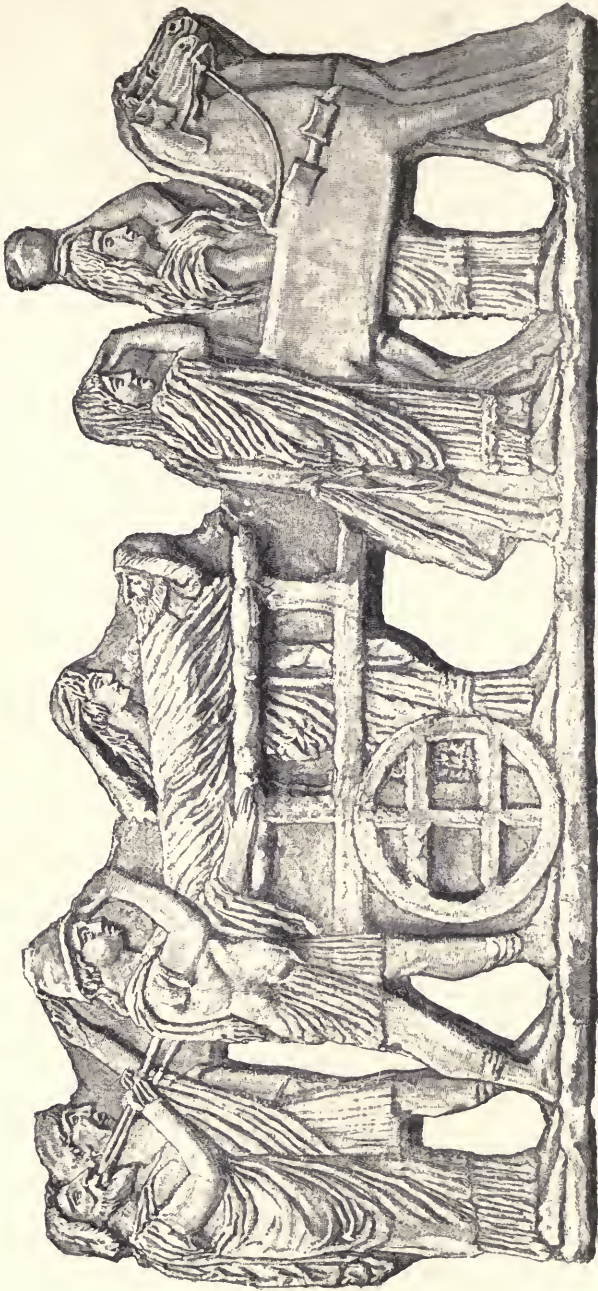

FIG. 115. — An Athenian Funeral Procession. Terra-cotta plaque, Paris.

After warding off the great coalition, Clisthenes fostered the burgher class, which was now increased by the admission of many Metoeci, and otherwise strengthened the democratic element in many ways. The power of the great magistrates was diminished, the influence of the Boulé enlarged, the number of officials to be elected considerably increased out of regard to the new development of the land. The presidency in the Boulé and the Ecclesia, the latter of which met from this time on the Pnyx, was transferred to the *epistates* or president of the fifty members of the Boulé, who held in turn the prytany. For the management of the public treasure deposited in the Hecatompèdon, on the Acropolis, a college of ten treasurers from the first class was formed. Ten Apodectæ ('receivers'), elected from all the classes, had control of the finances. Only the judicial functions of the King Archon remained unchanged. The Archon (eponymous) was restricted substantially to the honor of the presidency, to offering certain sacrifices, to the control of the so-called liturgies and of such festivals as were not under the direction of the King Archon, and finally to jurisdiction in family and heritage disputes, and to the oversight of minors. Besides the Polemarch, who retained jurisdiction over the Metoeci and freedmen, and especially presided in councils of war, and commanded the right wing in battle, there was a college of ten *strategi* or 'generals,' who in case of war were leaders of the contingents of the ten phylæ. Finally, in the administration of justice, Clisthenes introduced the important innovation, that there might be an appeal to the Heliaea from all decisions of the Thesmothetæ, who had been intrusted with the conduct of most processes and with prime jurisdiction in disputes about property. The number of the heliastæ was now considerably increased. Besides, there was from this time an appeal to the Heliaea from the objections of the Boulé in the examination of the magistrates elect, and the Heliaea had also to hear all complaints against retiring officials, to receive the reports of magistrates with regard to the conduct of their offices, and finally to release them from their obligations. The Ecclesia had jurisdiction also in cases of great importance where a citizen was accused of an offence against the state.

Not from the popular jealousy of great men, but with the purpose of providing against the dangers arising from conflicts between powerful party leaders, or against a renewal of the tyranny, Clisthenes determined to secure his work by the so-called *ostracism*. Every year, at mid-winter, the Boulé was to consult the Ecclesia as to whether the condition of the state required the banishment of any citizen. Only when

the question was answered in the affirmative by the majority could a day be set apart to vote upon the question. If in the vote six thousand tablets (*ostraka*) bore the same name, the Athenian thus designated was obliged to leave the country for ten years. Ostracism was not meant in any sense as a punishment, and affected neither the honor, nor the citizenship, nor the property, of the man in question. By vote of the assembly the exile could at any time be recalled.

Athens, whose free-citizen population is reckoned at this time at 100,000 souls, besides 30,000 to 40,000 *Metoei* and 150,000 slaves, had taken the form of a moderate democracy during the same period in which Sparta had developed an extreme form of aristocracy. Athens was now to enter upon the brilliant period in which it should show that, in the struggle for Greek independence, the discipline and patriotic devotion of its Ionic democracy was equal to the soldierly strength and endurance of the Dorian aristocracy.

CHAPTER VIII.

THE CONQUEST OF ASIATIC GREECE BY THE PERSIANS: WESTERN GREECE.

THE growth of the Peloponnesian league and of the Athenian democracy ran parallel with a new, and for Greek civilization very dangerous, development in Asia Minor. The Lydian king, Alyattes, not only subdued the Carians (after 610), but at a later period of his reign renewed his attacks upon the Greek maritime cities, not without considerable success. Smyrna fell after the year 580 B.C. into the hands of the king. Colophon also, whose vigorous citizens had been weakened by the luxurious and effeminate life to which the Ionians had begun to yield, was unable to hold out. Priene and Clazomenae were besieged, though unsuccessfully. The Greeks grew weary of a state of perpetual war, which ruined their flourishing estates. Miletus had, by its treaty with the Lydian crown, avoided all these troubles. When, therefore, Alyattes died in B.C. 563, and his young son Croesus made ready to conquer Asiatic Greece at any cost, the work was not difficult. In vain did the wise Milesian Thales urgently advise the Ionians to join in a strong federal union, collect their still very considerable forces, and make Teos, the geographical centre of the country, the seat of a federal council, which should direct with sovereign power the defence of the Greeks. His well-meant advice found no response. The Milesians themselves renewed the treaty with Croesus; and when the young king had completed his preparations, he found the Greeks divided and without definite plans. Croesus by no means wished to destroy or even to enslave them; he desired only the supreme authority over these rich cities, and to open their harbors to his kingdom. Quite ready to offer them good conditions, he exhibited on the other hand a superior military force. The case of the valiantly defended city of Ephesus, which after its surrender was generously treated, and even assisted by the king in the construction of the colossal temple of Artemis, had a decisive effect. By the year 560 B.C., with the exception of some places on the Hellespont, all the Greek cities of the Asiatic mainland had acknowledged the supremacy of the

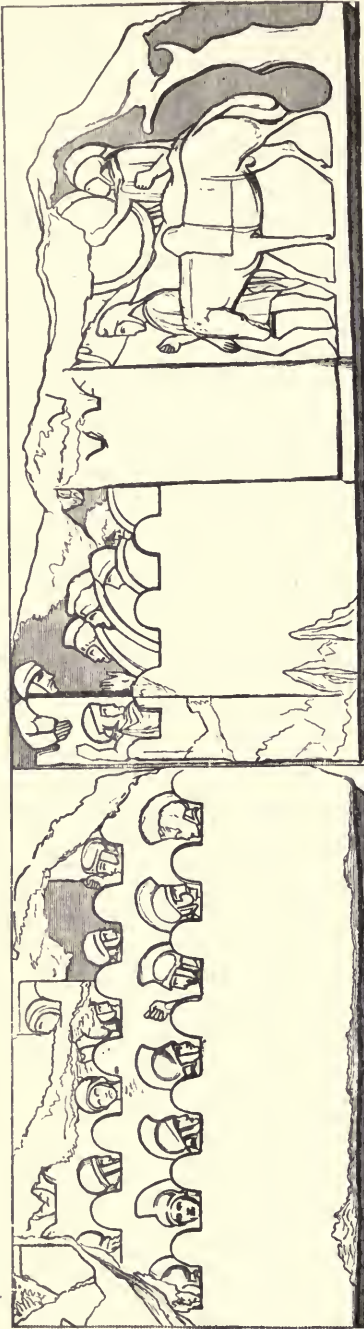

116



117

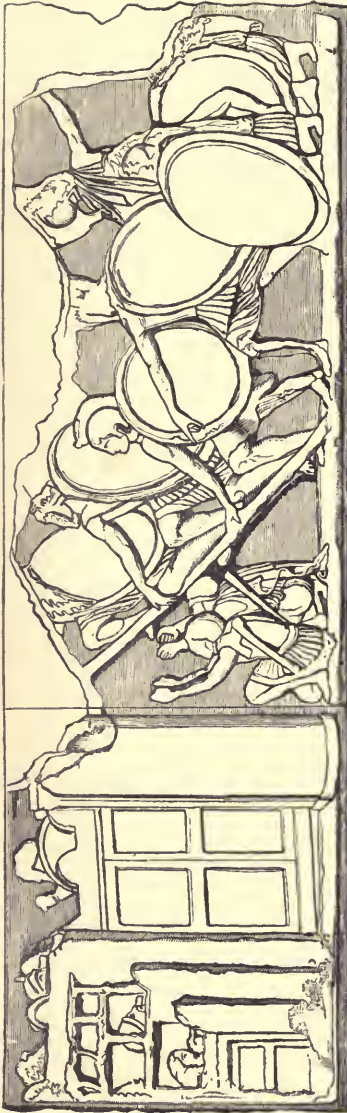

118



119

FIGS. 116, 117, 118, and 119. — Reliefs from a triumphal monument at Xanthus, (British Museum.) This relief was discovered by Fellows in 1838 at Xanthus in Lycia. It dates from the fourth century B.C., and is supposed to represent the capture of the Greek city of Xanthus by an army of native Lycians. The first section represents the preparations for defence; the garrison is ranged behind the triple city wall, while the auxiliaries from the dependent country pour in. In the second section the generals of the besiegers are urging a division to the assault. A few wounded men come dropping back from the walls. In the third we see the assailants storming one of the city gates. In the fourth the victorious commander receives the homage of the chiefs of the vanquished.

Lydian king. The hardest condition was that they should demolish their walls on the land side (as at Ephesus), or leave open the breaches made in war. On the other hand, they were relieved of Lydian garrisons, were required to perform no military service, and had only to send a yearly tribute to Sardis. (Figs. 116–119.)¹

This culmination of the Lydian power is also the time in which the Hellenes of the East reached the highest point of their material and intellectual development. They sent out colonies, and made sea-voyages to the Celtic and Spanish West and to the Egyptian Delta. In technical skill, which they had for the most part borrowed from the East, they were clearly superior to their Asiatic teachers. Architecture had flourished since the beginning of the seventh century, especially in the building of temples. These, though perceptibly influenced by the old wooden structures from which they were developed, soon show the difference between the Ionic and Doric styles, and, during the sixth century, exhibit an ever-increasing harmony in execution, and more and more majestic proportions. The oligarchy of Samos built for Hera, their chief divinity, after the end of the seventh century, a mighty temple. At Ephesus, in 590, the immense Artemisium was begun, which did not reach completion until 470 B.C. (Fig. 120). The Greeks of the old country successfully vied with these, especially at Delphi from 535, at Olympia from 550, at Athens under the Pisistratidae. Along with architecture the art of sculpture began to develop. Greek sculpture was long directed only to the representation of the gods. Originally wood-carving, it had, following Asiatic and Egyptian models, made considerable progress, principally in the sea-towns, especially after the opening of Egypt by the house of the Pharaoh Psammetichus, during the second half of the seventh century B.C. The Hellenes, who had invented in Chios, at the beginning of the seventh century, the art of soldering, began to fashion statues out of bronze with the hammer. In Samos the art of bronze casting was discovered about 600 B.C.; and in Chios successful experiments had for some time been made in Parian marble. This art, which was carried from Samos, Chios, and Crete to Sparta, and during the second half of the sixth century was cultivated with growing success in Aegina, Argos, and Athens, had by the middle of this century produced on the one hand forms that were artistic, though still stiff, and with little regard for the features of the face; on the other, it had made the transition from statues of the gods to bas-

¹ Figs. 116–119, though the monument from which they are taken belongs to a later date, illustrate warfare in Asia Minor.

relief portraits on grave-stones, and to portrait-statues. The studies of the artists were promoted by the attention paid to gymnastics and by the demand for portrait-statues.

The intellectual development was not less rich. Long after Homer, indeed, until after the middle of the seventh century, the epic poets used the forms of heroic poetry in the treatment of mythical and legendary subjects of the most varied character, as did also, though in much drier style, the Hesiodic school for the genealogy of the gods and their earthly loves. The Parian Archilochus diligently cultivated the elegiac measure, which had been developed in Ionia

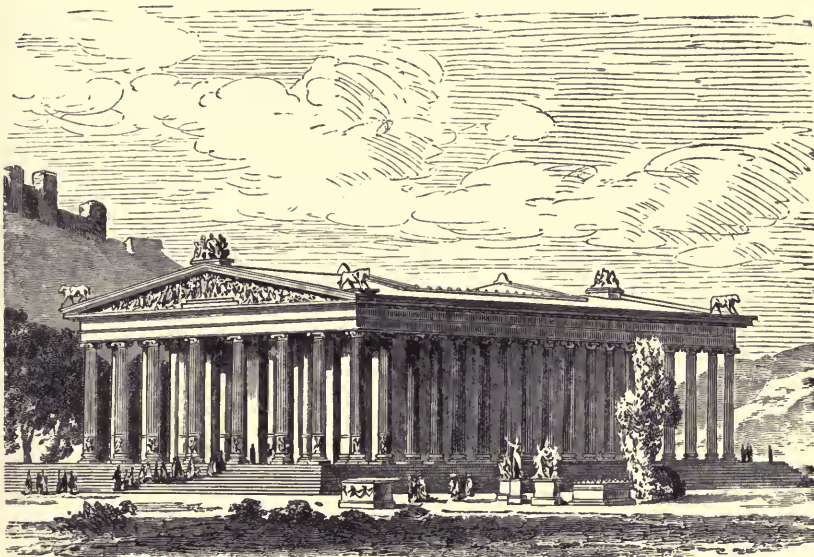

FIG. 120. — Later Temple of Artemis at Ephesus. (Curtius.)

toward the end of the eighth century. He too, as inventor of 'iambic' poetry in the first half of the seventh century, introduced poetry into daily life, and gave ridicule a poetic instrument. The Aeolian lyric poets of Lesbos, the contemporaries of Pittacus, should be mentioned here,—the fiery patrician Alcaeus, the passionate Sappho; also the Teian erotic poet Anacreon, the favorite of the lords of Samos and Athens; and Theognis, the stern representative of aristocratic sentiment in Megara. It is among the Ionians of Attica, in the course of the sixth century, that the beginnings and first development of the drama are found. There, from B.C. 512 on, the name of Phrynichus is prominent; and in the year 500, according to one account, the foundations of

a part of the theatre of Dionysus were laid at the southeastern corner of the Acropolis of Athens. In the commercial Ionian cities we find the beginnings of Greek science. The elements of astronomy and of physics, the first experiments in natural philosophy, the study of geography and ethnology, and finally historical writing find their first home here. Miletus leads the way with Thales (between 624 and 546 B.C.), who was also an able practical statesman; Anaximander (born 611), who made the first map of the earth; Anaximenes (575-528); and the great traveller Hecataeus, geographer and logographer (toward the end of the sixth century). But great wealth and the influence of the neighboring Lydians were opening the way for excessive luxury, debauchery, and effeminacy.

The condition of the Asiatic Greeks under the supremacy of Croesus was by no means unhappy. The rich and generous king was partial to the Greek people and Greek ideas, honored the gods of the Hellenes, and enriched with great gifts their sanctuaries at Miletus and Ephesus, as well as at Delphi. The Greeks in his kingdom, to whom the restoration of peace, and the opening of Lydia to their commerce, had brought great material advantages, were enjoying renewed prosperity, and were beginning to forget the loss of their independence. This period of peace and quiet was ended by the determination of Croesus to strike in season a great blow at the power of the Persians, that had been since B.C. 558 rising on the ruins of his old ally, the Median empire. He began his preparations in 551; not only formed an alliance with Babylon and Egypt, but secured, on the advice of the Delphic oracle, a promise of assistance from the Spartans (550). The war, which Croesus began prematurely in the spring of 549 with the Lydian troops alone, led, principally through his own fault, to the fall of the kingdom of Sardis. Late in the autumn of that very year his capital was taken by the Persians, and Croesus became a prisoner of Cyrus (Fig. 121).

The Greek cities of Asia Minor, after unavailing resistance, fell one by one into the hands of the Persians. The conquest was complete by 540; even Lesbos and Chios made voluntary submission, though the Persians as yet had no fleet.

The Persian rule was much more oppressive than the Lydian. There was no friendly encouragement of Greek interests, after the manner of Croesus. On the contrary, considerably heavier burdens were now laid upon the Asiatic Greeks. To the tribute was added the expensive and irksome duty of furnishing both a naval and a land contingent to the Persian armaments. Their municipal affairs, it is true,



FIG. 121.¹— Croesus on the Funeral Pile. Painting on an Athenian vase of about 490 B.C.

¹ This beautiful picture is from a vase found in lower Italy, and now in the Paris collection. King Croesus sits in long and royal apparel, his head crowned with laurel, on a richly ornamented stool, high up on the funeral pile. In his left hand he raises the sceptre; in the right he holds a sacrificial vessel, out of which he pours a libation to the gods. The pyre is formed of logs of wood laid crosswise, and the flames already begin to play around it; soon they will mount to the king's throne. But Croesus sits majestic and unmoved, in holy service, devoting his life to the gods. At the funeral pile a man lightly dressed, and crowned with a garland, is busy, whose name the artist has added [Euthymus]; the articles in his hands have been interpreted by some as torches, by others as instruments of sacrifice, so that he is either the kindler of the wood, or a religious subaltern engaged in the service. The artist has, it seems, intended to represent the tragic fate of the Lydian king, without intimating the conclusion of the story, which, indeed, was variously narrated. According to one widely spread version, the king was saved, Heaven interposing with thunder and lightning. This solution was possibly in the mind of the artist.

The picture belongs to the so-called severe style of vase-painting. In composition it is earnest and superior, answering to its subject in a way equalled by few other such pictures of the early part of the fifth century B.C.

were not interfered with. But it was impossible to avoid the lawless despotism, the whims, and the arrogance of the satraps (governors) and their lieutenants, their deeds of violence, extortion, chicanery, and the abduction of beautiful women for the harems. Garrisons were not stationed in the Greek cities, but it was the Persian policy to encourage powerful citizens to establish tyrannies. Supported by the Persians, who treated them as their hyparchs, or lieutenant-governors, and held responsible to the king for the fidelity of the cities, these tyrants shaped for full four decades the otherwise unknown history of these Greeks under Persian supremacy.

Quite independent, on the contrary, was the rule of Polycrates, who, immediately after the Persian conquest of Asia Minor, created on the still free island of Samos a principality after the fashion of the old tyrants. The patrician Geomori had, notwithstanding an outbreak of popular rage in the year 565, valiantly maintained their supremacy on this beautiful island until past the middle of the sixth century B.C.; but it was gradually undermined. Even though the Geomori refused submission to the Persians, they still remained odious to the commons. Depending on this feeling of the common people, a rich nobleman, Polycrates, the ambitious son of Aeaces, whose arts had won the masses, made a bold venture by which he got possession of the Acropolis of Samos. But not till he received aid from Lygdamis, prince of Naxos, was he able to gain control of the whole island. The strength of the Geomori, and the manner in which he had risen to power, gave to his position always a character of insecurity, and made his rule especially despotic. Polycrates sought especially to secure himself by alliances with the courts of Naxos and Athens, and with the great Pharoah Amasis of Egypt, by a rigid administration, and by a large guard of mercenaries. He was finally overthrown in 521, and in 516 the island came under Persian sway.

The despotism of Polycrates had driven from Samos the celebrated philosopher Pythagoras, who was born probably about 580 B.C. in Samos, and had during a long stay in the east, especially in Egypt, developed peculiar philosophical views. He fled from Samos about 532 to Lower Italy, and established himself in the city of Croton, a centre of learning, long famous for its medical school. Here he won numerous disciples to his system, in which religion and philosophy were intimately blended.

In the ideal conception of this great thinker, Apollo, god of light and purity, was in the highest sense the god of eternal order, law, har-

mony, of an exalted and spotless life, of atonements and purifications. On the foundation of his theory of the universe, which culminated in the completest harmony of the material and the spiritual world, Pythagoras built a system of ethics which imposed upon his followers high moral demands and a strict outward discipline. The doctrine of Pythagoras was naturally limited to very few, but the consequences which he drew from it for ordinary life secured him a hearing and influence in larger circles.

If these consequences had been confined to the domain of morals and religion, his influence would not have been felt far beyond his school. But as Pythagoras advocated some very definite political theories, the result was different. In the Achaean cities of Italy timocracy had gradually hardened into oligarchy, and thus had called forth a strong democratic opposition. The Achaean Sybaris, from about 560 B.C., claimed to be the richest and most brilliant city of the Greek world. Sybaris ruled over four tribes of Oenotrian aborigines and twenty-five smaller towns, and possessed, in a circumference of five and a half miles, 100,000 inhabitants, of which 5000 were knights. The citizens were haughty, luxurious, and effeminate. Among them debauchery and immorality were unrestrained. About 520 B.C. the demagogue Telys overthrew the power of the aristocracy, and drove into exile five hundred of the chief land-owners, whose possessions were confiscated. The exiles fled to Croton, which just at this time was vigorously governed by a very decided aristocracy. Though Croton was smaller and less wealthy than Sybaris, its inhabitants (also Achaeans) were far more vigorous than their luxurious neighbors. The nobility furnished excellent athletes, the strongest and most celebrated of whom was the wrestler Milo, who was likewise a capable officer and statesman. The aristocracy of Croton, it appears, had been materially strengthened through the influence of Pythagoras. It was only natural that his ideas of law, which was to emanate from and be administered by those only who had been initiated into the 'higher wisdom,' and of the strict obedience which the citizens owed to such law, should find a quick response among the cultivated aristocracy of Croton. The philosophical confirmation of aristocratic authority would necessarily, wherever these theories were accepted and observed, deepen and sharpen, even render irreconcilable, the opposition to the commons. The higher or 'esoteric' principles of Pythagoras were shared only by a select society of three hundred pupils; but the political part of his philosophy was more widely spread, and was held and advocated by clubs, or 'hetaeriae,' at Croton, Metapontum, Tarentum, and other places.



FRONT VIEW.

FIG. 122. — The so-called Nicopolis silver vase, with representations of Scythians. From a Scythian grave in Southern Russia. (St. Petersburg, Hermitage.)



SIDE VIEW.

FIG. 123. — The so-called Nicopolis silver vase, with representation of Scythians. From a Scythian grave in Southern Russia. (St. Petersburg, Hermitage.)



124.



125.

Figs. 124, 125. — Representation of Scythians on the shoulder of the so-called silver vase of Nicopolis. From a Scythian grave in Southern Russia. (St. Petersburg, Hermitage.)



126.

127.

FIGS. 126, 127. — Representation of Scythians on a silver vase from an old Scythian grave in Southern Russia. (St. Petersburg, Hermitage.)

The political influence of Pythagoras soon led to a war with Sybaris. Telys had, in B.C. 515, been deeply insulted by the action of the Crotoniate nobles in banishing the Olympic victor Philippus, who was engaged to his daughter; and he threatened the Crotoniates with war in case they did not give up to him the Sybarite fugitives. While the knights of Croton, who were scarcely able to raise a third of the force which Telys had at command, wavered as to their answer, the word of the Samian philosopher decided for war. The conflict began in the year 511. A battle was fought on the river Traeis (now Trionto), in which the Sybarites were defeated by the troops of Croton and the superior generalship of Milo. Sybaris surrendered after a siege of seventy days. Most of the inhabitants fled to their colonies in Lower Italy, but the city itself was utterly destroyed.

This shameful barbarity bore evil fruit for Croton. The city was too weak to maintain its supremacy over the Oenotrian tribes; and the victory led to ruinous internal commotions. The citizens and peasants were already embittered toward the Pythagoreans, a secret order from which serious innovations, even in their religion, were feared. The commons found now a leader in a distinguished man, Cylon by name, who hated Pythagoras because he had been refused admission to the order. And when the aristocratic council stubbornly rejected the proposed change to a more democratic form of constitution, and the distribution among the people of the Sybarite territory, insurrection broke out (506 B.C.). The change in the constitution was carried by force, the leaders of the nobility were banished, and a considerable number of the Pythagoreans were put to death. Pythagoras himself, forced to flee, died afterwards at Metapontum (about 500). The persecution of his school spread to several other places in Lower Italy.

The Achaean cities of Magna Graecia never recovered from these disastrous wars and commotions. The supremacy in this quarter passed over to the native Italian tribes, and to the Dorian city of Tarentum, where also the philosophy of Pythagoras had found a new place of refuge.

Meanwhile the Persian arms continued to advance. Darius I. readily crushed the revolts which broke out on his accession in B.C. 521, and in 517 began to prepare to turn his arms against the West. He proposed first to subdue the wild Scythian peoples north of the Danube Delta and the Black Sea. The Persian troops, who had conquered Samos, had first to occupy the Greek cities on the European side of the Hellespont and the Propontis, and on the Bosphorus, in order to secure

the passage of the king from Asia into Europe. At that time Darius received homage from the Attic prince Miltiades, in the Thracian Chersonese, as well as from the cities of Perinthus, Selymbria, and Byzantium. He then collected an army of 700,000 men in the northwestern part of Asia Minor; while the Asiatic Greeks had to fit out 600 ships, and the Samian architect Mandrocles to build a bridge of boats across the Bosphorus. This immense army advanced in the year 513 through Thrace toward the lower Danube, while the Greek fleet sailed up this river to the head of the delta. Here the Greeks built for the Persians a bridge of boats, which the Greek viceroys were to guard while the king was absent on the expedition. As he was returning from the upper Dniester toward the Danube, the Scythians (Figs. 122-127) tried to persuade the Greek princes to destroy the bridge, and leave the king to his fate. But their advice was seconded only by the Athenian Miltiades. In the council of chieftains, the view of the princes Histiaeus of Miletus and Coës of Lesbos prevailed, that faith must be kept with the Persians, on whose authority that of the Greek tyrants depended. The plan of Miltiades was rejected, the excited Greek troops kept firmly under control, and the king rescued. Some revolts which had broken out along the Propontis were soon suppressed; and Persian armies were despatched to fresh conquests,—one under Otanes, to conquer the islands of Lemnos and Imbros, while another, led by Megabyzus, advanced westward along the north coast of the Aegean Sea, took Doriscus at the mouth of the Hebrus, and subdued the Thracian coast as far as the Strymon, thus reaching the eastern border of the kingdom of Macedonia. Amyntas I. was obliged to pay homage to the Great King (512). He retained his kingdom, but ruled actually from this time only as Persian viceroy. This extension of the Persian empire to the passes of Olympus naturally suggested to Darius the conquest of European Greece also. Only the subjugation of all the lands as far as Taenarum would secure the Persians from the danger that the Asiatic Greeks might at the first opportunity, with the help of their kinsmen, throw off the foreign yoke. Darius, who proceeded cautiously in all his campaigns, now sent out a Persian expedition to study carefully the coasts of European Hellas, as well as those of the Italiotes and Siceliotes (511 or 510 B.C.). When he went back to Susa, after the return of Megabyzus from Thrace, he intrusted his shrewd and energetic brother, Artaphernes, with the satrapy of Lydia. The hyparch Histiaeus he took with him as his confidential counsellor to Susa.

The operations of Darius in the years 510-502 made the Persian

power more and more formidable. The new organization of the vast empire, the building of the royal road from Susa to Sardis, with the postal system attached, the new division of satrapies, which had existed now since about 515, with their regular system of taxes, all contributed to bring the colossal resources of Asia into the shape most useful for the Achaemenidae. On the sea they had at their disposal the excellent fleet of the Phoenicians, who were animated by their old hatred of the Greeks. In contrast with the united and gigantic power of the east, Greece appeared torn and divided. The Hellenes consumed their abundant strength in local feuds. It was impossible to see how the forces of the Thessalians, Boeotians, Athenians, and Peloponnesians could ever be united into one army. The most of the Peloponnesians were really united internally, but unfortunately Sparta was at this very time on bad terms with Athens. And the very energy with which democratic Athens was now developing her strength seemed to be destined to bring the Persian war to an immediate outbreak. When Hippias, in the year 505, lost hope of being restored by Spartan help, he betook himself to Sardis, and made every effort to induce the viceroy Artaphernes to conquer Attica for Persia, and then restore the control of Athens to the Pisistratidae. The Athenians sought to meet these intrigues by an embassy; but Artaphernes, considering the overhasty consent of the Athenian ambassadors, in 507-6 (p. 146), as a standing agreement, and the Athenians, therefore, as his subjects, declared to them that if they valued their safety they must unconditionally restore Hippias. As that could not be, war was practically declared. Such was the condition of affairs when suddenly and unexpectedly the flame of war blazed up on Asiatic soil.

BOOK II.

FROM THE BEGINNING OF THE
PERSIAN WARS TO THE BAT-
TLE OF MANTINEA.

(B.C. 500-362.)

PART III.

FROM THE IONIAN REVOLT TO THE BEGINNING OF THE PELOPONNESIAN WAR.

(500-432 B.C.)

CHAPTER IX.

THE PERSIAN WARS.

THE immediate occasion of the momentous conflict between the European Hellenes and the Achaemenidae was a party conflict on the island of Naxos. The oligarchs, who, after the fall of the tyrant Lygdamis, in 524 B.C., had been restored to authority by the Spartans, were, toward the end of the century, driven out by the commons, and turned now, in the year 501, to Miletus for help. Histiaeus had been their friend; and his successor, his ambitious and selfish son-in-law, Aristagoras, was quite ready to win the favor of the king by a war against Naxos, which should restore on this island oligarchic rule under Persian supremacy, and might possibly win the rest of the Cyclades for Persia. Since Naxos could raise 8000 hoplites and a strong fleet, Aristagoras had first to assure himself of the help of Artaphernes. As the Naxian fugitives promised to pay the cost of the expedition, the satrap, with the consent of the king, caused 200 ships of war to be fitted out by the Asiatic Greeks, and placed his cousin, Megabates, at the head of Persian land forces. Aristagoras had to stand surety to him for the costs. The forces assembled at Miletus in the early spring of 500 B.C., amounting to about 50,000 men, were to fall unexpectedly upon the unprepared Naxians. But Naxos had been warned, directly or indirectly, and prepared now to make a vigorous resistance. When finally the Milesian and Persian army arrived at the island, Aristagoras made, in the course of a four months' blockade, not the slightest impression upon their capital.

Aristagoras found himself on his return to the harbor of Miletus in a predicament. He could but expect that Megabates would accuse

him at the Persian court as the sole cause of the misfortune. Besides, he would be ruined by the payment of the costs of the war; and he was in danger of losing the hyparchy, if nothing worse. At this juncture he conceived the idea of saving himself by persuading the Greeks to revolt from Persia. The plan was really criminal. Just now, under the sound administration of Darius, who was personally well disposed to the Greeks, the bad features of Asiatic government were much relieved, though the new and regular taxation may, indeed, have been felt at the time as somewhat oppressive. Besides tolls and tribute in kind, and the cost of the support of the provincial government, the Ionian satrapy had at that time to pay annually, in direct imperial taxes, 300 talents (about \$360,000). But no prudent man in Asiatic Greece would have found in these circumstances cause for a revolt. Aristagoras, however, rightly reckoned on the magic influence of an appeal for national freedom and democracy. His last scruples were relieved by the arrival of a messenger from Histiaeus, calling upon him to rouse the Ionians to revolt. Histiaeus, who desired to return to the Greek world, had, it is said, conceived the despicable plan of inducing the Hellenes to revolt, in order that Darius might send him to subdue them.

As Aristagoras expected, his scheme was eagerly embraced. The crews of the fleet, which was anchored at Myus, on the Maeander, joined him with enthusiasm. Aristagoras openly laid down the hyparchy at Miletus, restored freedom to the commons, and with his fleet drew into the movement within a few weeks all the Greek islands and coast cities from southern Caria to the Hellespont. Blood had not yet begun to flow; the tyrants in the several Greek cities in Asia were in general simply banished. It now became necessary to prepare for war in good earnest. Artaphernes, taken completely by surprise, was for the time unable to check the spread of the revolt. But Aristagoras knew that Darius, whose hands were just now perfectly free, would not quietly endure the loss of the Greek provinces, but would as quickly as possible put in motion immense land forces, as well as the Phoenician fleet. If, then, the Greeks wished to win even tolerable conditions of peace, it was necessary that the revolt extend as far as possible, that their forces be united, that finally the Greeks of the mother-country should lend their support.

So it was determined that the forces of the Greeks should assemble at Ephesus, with a view to attacking Sardis in the spring. Aristagoras meanwhile, in the winter of 500-499, sought to win the aid of Sparta.

It was natural to expect that this would be readily granted. Every Greek statesman worthy the name must see instantly that there could be nothing more opportune for the European Greeks than this Ionian revolt, which, keeping the Achaemenidae occupied at home, would leave them no time to think of carrying out their evident plans against European Greece. But the ephors and the kings Demaratus and Cleomenes, unable to see beyond the narrow horizon of Peloponnesian politics, declined to lend aid. Thus had a chief element in Aristagoras's calculation failed before the first collision with the Persians. The Athenians, however, sympathized with their kinsmen; but, pressed as they were by the Aeginetan war, they could only promise twenty ships, to which five from Eretria were to be added.

Thus in order to meet the great armaments which the Persians had determined on, Aristagoras had to rely mainly on a prudent disposition of the forces of the Asiatic Greeks, and upon the spread of the revolt. While the Phoenician fleet was prevented from sailing to Miletus by the revolt of Cyprus, Aristagoras, in the spring of B.C. 499, opened the war against Artaphernes, with the hope of capturing Sardis if possible, and of bringing Lydia into revolt. When the Greek contingents, including the Attic and Eretrian troops, had assembled at Ephesus, they left the fleet in the harbor at the foot of Mount Coressus, and marched against Sardis, led by two Milesian generals. Artaphernes, unable to hold the lower city, retired to the Acropolis. As the Greeks entered Sardis a soldier wantonly set fire to a reed-thatched house. The fire spread, and the whole city fell a prey to the flames. The Lydian inhabitants, whose accession the Greeks had reckoned on, now turned, justly indignant, upon the latter, who, hard pressed besides by a vigorous sally of Artaphernes, withdrew to the heights of Tmolus, and then towards Ephesus. Artaphernes, with the Persian troops, pursued them. A battle was fought in the summer of 499 before the gates of Ephesus, and the Greeks suffered a defeat which decided the course of the war. Confidence in success was gone. It was of little avail to the Ionians that the news of the capture of Sardis induced the Carians and Caunians in the south, and in the north the Greeks from the Hellespont to the Bosphorus, to join the revolt. The Ionian contingents returned to their respective cities. Offensive operations were no longer possible. The Athenians hastened home, and took no part henceforth in Ionian affairs. But they had done enough to draw down upon Athens the implacable hate of the Persian rulers. Aristagoras, however, did not yet despair. Summoning an Ionian federal and military

council, he proposed to bring speedy and abundant help to every point attacked by the Persians. But the superior power and shrewd strategy of the Persians forbade much hope to be placed in this very sensible plan.

Darius had armed such multitudes of troops that the Persians were able to attack simultaneously with different divisions the various rebellious provinces. One city after another fell, until, in 497, Aristagoras selfishly abandoned the cause of his people, and withdrew, with a band of his followers, to Myrcinus on the Strymon, where in the autumn of the same year he found an inglorious death in a conflict with the Thracian natives. His father-in-law, Histiaeus, did not obtain the expected reward of his trickery. Darius had indeed sent him to Ionia to put down the revolt. But when he appeared in Sardis, the sharp-sighted Artaphernes roundly accused him of being the instigator of the insurrection. "Thou, Histiaeus," said he, "madest the shoe, and Aristagoras put it on." Histiaeus thus lost all support, and finally fell so low as to become a leader of pirates in the Bosphorus.

In the autumn of B.C. 497, besides the islands of Lesbos, Chios, and Samos, only the cities of Miletus, Myus, Priene, Teos, Erythrae, and Phocaea still held out. In 496 the Persians directed their whole land force and a large fleet, consisting especially of Phoenician vessels, against Miletus. Near the island of Lade (now a part of the mainland) which formed and protected the harbor of Miletus, the Greek fleet, numbering 353 triremes, had lain since spring. The Persian fleet, although numbering 600 sails, refrained for a long time from the attack because they hoped that the tyrants of the cities, who had been expelled in the year 500, could by secret negotiations induce their former subjects to abandon the insurgent cause. When the battle finally occurred in October 496, and the Milesians on the left, the Phocaeans and Chians in the centre, were fighting with great bravery, forty-nine of the sixty Samian ships, which held the right wing on the high sea, suddenly took to flight, causing the complete overthrow of the Ionian fleet. Miletus, now closely besieged by land and sea, was taken by storm in the summer of 495, most of the men slaughtered, the women and children carried away, the houses plundered, and finally burned. The Persians now put down the remains of the revolt everywhere. In the autumn of 495 the whole of Caria submitted. In the spring of 494 the Persian land army and fleet advanced northward, the former along the coast, the latter from island to island, burning as far as the Bosphorus all cities (except Samos) which had not capitulated before,

172¹



Darius Holding
 Painting on an ancient Greek vase



Council of War.
Scene from Canosa, in Apulia.

carrying off numberless boys as eunuchs, and innumerable girls for the harems. Histiaeus fell into the hands of the Persians and was crucified. Miltiades, of the Chersonese, an object of especial hatred to the Persians since his attempt to induce the viceroys to burn the bridge over the Danube, fled with four or five ships to Athens.

Now at last Artaphernes deigned to be humane toward the unhappy Greeks. They were allowed to assemble on the sites of their burnt cities. The burden of tribute was lightened. A few of the tyrants were restored; but otherwise it was deemed advisable to allow the Greeks to adopt, at their pleasure, democratic, timocratic, or oligarchic forms of government.

On Persian soil the war was now ended; but Darius determined to carry out his old plan of punishing Eretria and Athens, and of conquering European Greece. With this view he had ordered extensive levies to be made in the interior of the Orient. The young and fiery Mardonius, his son-in-law, led these troops, with the accompanying fleet, in the spring of 493, from Cilicia to the Hellespont, and was there joined by the forces which had been, since the close of the preceding year, encamped on and near the Chersonese. Mardonius proposed to enter Greece by the way of Olympus, while the fleet was to follow along the northern coast of the Aegean Sea, and take possession of the gold-producing island of Thasos. He succeeded entirely in his first duty, to reconquer and make secure the European possessions of Darius, which since the outbreak of the Ionian revolt had been really independent. The whole country as far as Tempe fell into the hands of the Persians. Even the young Alexander I., king (since 498) of Macedon, became a vassal of Persia. Still, the Persians did not reach Thessaly. An expedition, undertaken rather in Macedonian than in Persian interest, against several Thracian tribes of the interior, especially against the Brygians, cost much time and blood. Meanwhile the Persian fleet, on which the army depended for supplies, met with a terrible storm on the voyage round the promontory of Athos, losing 300 ships and 20,000 men. Under these circumstances Mardonius returned to Asia.

The European Greeks soon perceived that the danger which threatened their national independence would in a short time return with increased force. It was learned that Darius (PLATE IX.),¹ in order to

¹ EXPLANATION OF PLATE IX.

The so-called Darius Vase is one of the noteworthy remains of the ceramic art of the Greeks. It was found in 1851 at Canosa in Apulia (the ancient Greek colony of *Karύστιον*) and is now in the National Museum at Naples. It is an amphora 53 inches in

secure the countries between the Bosphorus and the Strymon, had placed Persian garrisons in Byzantium, Cardia, and Sestos, had turned Doriscus and Eion (at the mouth of the Strymon) into strong fortresses, and established a naval station at Elaeus on the southern extremity of the Chersonese. There were rumors, too, of new and immense armaments by land and sea. Another sure sign of the approaching conflict was the appearance, in the summer of 491, of heralds everywhere in Greece, demanding, according to Persian custom, 'earth and water' as tokens of homage. The first question concerned the attitude of the Spartans. They had not been able to decide to support Aristagoras, and thus defend the freedom of Greece on the Asiatic territory. Worse still, they had during the death struggle of the Ionians, in 495, begun a war

height, and belongs to the class of Lower Italian vases, which from various indications of style are assigned to the third century B.C.

The figures are arranged in three rows. In the middle row King Darius, in his royal robes, sits on a richly ornamented throne. He holds a sword in his left hand, a sceptre in his right. A life-guardsmen stands behind him. Before him stands a man plainly clad in a sleeved robe, high boots, and hat; he stands on a low platform, or pedestal, and energetically addresses the king. His character as representing the Persian populace is indicated by the inscription (*Πέρσαι*) on the platform. He is a plain Persian citizen, who brings tidings to his sovereign, which according to court ceremonial he can only deliver from the golden platform before the throne.

The nature of the news is indicated by the sadness depicted on the countenances of the messenger and of the surrounding councillors. Of these, two are in Oriental garb, with long-sleeved robes and peaked caps; three are in plain Grecian costume, without head-coverings. The latter, without doubt, are intended to represent some of the Greek exiles dwelling at the court of the Persian king, of whom Demaratus and Hippias are examples.

That the council is deliberating concerning a new campaign against Hellas, is shown by the upper row of figures. Here Zeus sits in the centre, with sceptre and thunderbolt, while Niké (Victory) leans against him. He turns toward Hellas, who, clothed in a long garment, stands timidly at his side. Athena stands next, in full armor, resting her hand protectingly on Hellas's shoulder. Beyond Niké, on the left, are the gods friendly to Hellas; Apollo with his swan, Artemis on her hind.

In contrast to Hellas, who puts her trust in the gods, we see vainglorious Asia seated on an altar with a Herma at the right, bearing diadem and sceptre, and gorgeously apparelled. She listens greedily to the words of Apaté, the goddess of infatuation, who stands before her, and has evidently persuaded her to a campaign against Hellas. Apaté is in the garb of the Erinnyes, and grasps the torch of war.

The lower row shows us five Persians, humbly bringing their tribute to an official, who is seated at a counting-table. The official has a tablet in his hand; on which presumably he checks off the taxes as received. On the table are signs corresponding to the different coins, that a separate pile may be made of each.

It is the purpose of the artist to bring vividly to view the contrast between the Persian king, whom, relying on empire and power, infatuation impels to war against Greece, and Hellas, weak in comparison according to the standards of this world, but strong through reliance on the gods. He therefore has in view, probably, the time between the destruction of the Persian fleet at Mt. Athos, and the battle of Marathon, while Darius still purposed the humbling of Greece. Nothing in the representation points towards the period after Marathon, when the Persian power was for the time being completely overthrown.

for the political destruction of Argos, in which Cleomenes had inflicted upon the Argives at Sepea, near Tiryns, and in the holy grove of Argos, a murderous defeat, 6000 hoplites being slain. But Sparta now showed herself, at the critical moment, conscious of her position and of her duty as the leading state in Greece. When the heralds of the Great King appeared, the pride of the Spartans revolted at the shameful suggestion of yielding without a battle; and in blind rage they hurled the heralds into a well, saying scornfully, "There you may get for yourselves earth and water for your king!"

But all the islands, where mortal fear of the Phoenician fleet prevailed, did homage to the king, even Aegina, powerful as she was at sea, sending the tokens of submission to Susa. On the mainland, too, not a few cities lost heart. So much the more energetic was Athens, which now entered upon the era of her greatness. The destruction of the Ionians, the cruelties of the Persians and Phoenicians, had deeply affected and humiliated the Athenians, and caused them to resolve upon the most valiant resistance. Fortunately for Greece they possessed now men whose mental and moral force, whose political and military talent, was equal to the crisis. The great body of the Eupatridae had honestly submitted to the new order of things. To the associates and successors of Clisthenes already mentioned, to Aristides, the purest and most unselfish character of this period, and to the Alcmeonid Xanthippus, were now added two other men of the highest talent, whose names are indissolubly connected with the history of the Persian wars. One of these was the highly gifted Themistocles (born about 525 B.C.). Recognition of his ability and genius had hitherto been prevented by the memory of his dissolute youth.

Many, unfortunately even Aristides for a time, considered him a double-faced man, whose unscrupulous methods in money matters, whose self-willed, impetuous disposition, ought to excite mistrust. Against the sexagenarian prince Miltiades, too, the untimely jealousy of the Alcmeonidae was directed. But for the present his generalship and his knowledge of the dreaded Persians made him indispensable to Athens. Through the influence of all these men the demands of the Persians were roughly refused. Unfortunately, here, too, the laws of nations are said to have been wantonly violated by the murder of the heralds.

A like determination and like guilt caused the Athenians and the Spartans in this critical moment to forget their fifteen years' hostility. Athens's need, resulting from the war with Aegina, and the lofty patriotism displayed by the Athenians from this time on, led them first to

offer the hand to the Spartans. They shrewdly acknowledged Sparta as the leading power in Hellas, and requested her as head of the Peloponnesian alliance to punish the Aeginetans, who, it was claimed, by their submission to Persia had committed treason against Greece; while only in this way could Athens hope, for the time of the Persian war at least, to be relieved of the Aeginetan feud. Sparta readily consented. The island was compelled to give ten hostages, which were delivered to the Athenians in the autumn of 491.

This precaution rendered Athens secure on the Aeginetan side; and it was high time, for the storm was approaching. The 600 sail with their crews of 90,000 men, which had assembled in the spring of 490 B.C., in the Cilician harbors, in order to take on board from 70,000 to 100,000 picked Iranian warriors, were this time to threaten Athens first of all. The plan of Darius, which his nephew Artaphernes and the Median general Datis were to carry out, was to transport the army direct from Cilicia across the Aegean, and attack first Euboea and Attica. This plan was pushed forward with energy and success. On the voyage the fleet stopped only at Naxos, where the honor of Persian arms was to be vindicated. The people fled to the mountains; Naxos was burned to the ground, and many of the inhabitants dragged away as slaves. The Persian fleet sailed next to Euboea; Eretria, which was re-enforced by the 4000 Attic colonists in the territory of Chalcis, wavered, for even here were traitorous elements. Fortunately a citizen induced the Attic auxiliaries to withdraw in time to Attica. Eretria itself held out very bravely for six days; but on the seventh day the Persians, by the help of two traitors, forced their way into the city, reduced it to ashes, and enslaved a large part of the population.

The Persian generals now landed unhindered in Attica, which they proposed to reduce to a state of vassalage under the aged Hippias, who accompanied the Persian army. They would probably have done better to land in the bay of Phalerum, and give battle to the Athenians on the plain before the capital, or to besiege Athens instantly. But Hippias, who acted as guide for them, remembering his triumphant expedition in the year 538, caused them to land at Marathon, near his paternal estates and the hill country, whose inhabitants had once been friendly to his house. Hippias, who was unacquainted with the new spirit of the Attic commonalty, and the Persian commanders waited for the result of the intrigues which the old prince was carrying on with the friends of his house. Thus the patriotic party at Athens gained time. For this decisive year the Athenians had chosen as polemarch the excellent Cal-

limachus, and among the generals, Aristides — perhaps also Themistocles — and Miltiades. As soon as the report came to Athens that the Persians had reached the eastern coast, the council of war despatched the courier Phidippides to Sparta, to beg for the aid which had doubtless been agreed on in this event. The Spartans answered, that, as they were celebrating a festival, they could not march before the full moon, that is, could not be in Attica under eight days. It was Miltiades now, who, supported by Aristides, Themistocles, and Callimachus, urged to march out and attack the Persians. There was danger, it is true, that the Persians would divide their forces, engage the Athenian army on the



FIG. 128. — The Plain of Marathon. (From a drawing by H. Belle.)

east coast with one part, and with the other at the same time attack the city. Still, the Attic troops could not allow themselves to be shut up in the city. If Athens were besieged its relief was very doubtful; and it was to be feared, too, that the treachery of Eretria might be repeated here. As soon as the valiant resolution was confirmed by the assembly of the people, the generals committed the city to the guard of the elderly citizens. The army for the field, of 20,000 men, 9000 being hoplites, marched by way of Cephisia and along the northern declivity of Pentelicus to Marathon, where the Athenians took a strong position west of the town on a height in the sacred grove of Heracles, behind the present Vrana (Fig. 128). Thjs they further strengthened against

the attacks of the Persian cavalry by felling trees in front. On the second day they received a very welcome re-enforcement of a thousand hoplites from the faithful Plataea. Miltiades, to whom the other generals willingly yielded the chief command, now determined to give battle on the second day after the arrival of the Plataeans.

It probably occurred to the Persians, after they had been encamped here for ten days, to utilize their superior force, and take advantage of the critical situation of the Athenians. Probably the intrigues of Hippias had had some effect, and the Persians thought they could reckon on a movement in their favor in Athens. We may assume, then, that on the morning of the day which has been made ever memorable by the battle of Marathon (September 12, 490 B.C.), the Persians divided their army. About 50,000 men remained at the camp. The infantry advanced in order of battle to deceive the Athenians on the heights, or to engage them in a skirmish. The other half, including probably a part of the cavalry, which was to operate against Athens itself, was embarked, and was to remain at Marathon until a signal should be given from the top of Pentelicus, — a signal which, in fact, was not made till the battle was over. It is possible also that Miltiades by connections in the Persian camp was informed in time of the plans of his antagonists, and so saw the necessity of striking a blow instantly. At any rate, on the morning of September 12 the Attic general led out 10,000 hoplites and more than as many slaves. His plan was to overthrow the Persian infantry by a fierce onset of the hoplites. The Persians were drawn up in front of their camp, about three miles from the shore, in solid columns twenty men deep and 3000 long. A large swamp to the north and a smaller one to the south made any considerable use of the cavalry impossible, — the cavalry is not mentioned in the ancient accounts of the battle, — and hindered the Persian infantry from manoeuvring with ease and outflanking the Greeks. Miltiades boldly extended his front as much as possible, to prevent any flank movement; leaving the phylae in the centre, led by Aristides and Themistocles, only three, those on the wings six, men deep. Callimachus led the right wing, the Plataeans stood on the left, the slaves, armed with slings, were arrayed behind the hoplites. Miltiades led his hoplites through the plain, 4800 feet, at double quick, that they might not be exposed too long to the fearful hail from the Persian bowmen, and, in fact, reached the Persians without great loss. The Perso-Median infantry was at that time still very fine. The lances and bronze armor of the hoplites had not yet proved their superiority over

the weaker defensive weapons, the bows and sabres, of the Asiatics. The centre of the Athenians was broken, the hoplites, and still more the slaves, suffered heavy losses. But finally the Greek wings forced back and routed the Persians. Miltiades immediately swung the wings right and left, and threw them upon the picked troops of the Persian centre. As usual in ancient battles, the Asiatics suffered greatest loss in their flight, in which many of them were driven into the northern swamp. The defeat did not end in utter rout, because the fleet was near by to receive the fugitives, and to cover all that were able to reach the shore.

The Asiatics, among whom the Median contingents had suffered most, had lost 6400 men. The Athenians mourned the loss of 192 hoplites (see Fig. 129), and the polemarch. They had captured the Persian camp with its rich booty and seven ships that were not ready to sail. But there was no time to rest. Apart from the suspicious signals observed on Pentelicus after the battle, Miltiades found — but probably not till noon of the day after the battle — that the Persian fleet had sailed toward Sunium. It was clear that Datis was steering for Phalerum, in order to attack the weakly defended city. The Greek troops hastened, therefore, in the afternoon by a forced march back to Athens, arriving late in the evening. The party of Hippias did not now dare to stir; and when on the next morning the Persian fleet appeared, and found the shore covered with the troops of Miltiades, Datis did not attempt to land. As he probably



FIG. 129.—The so-called "Marathonian Soldier,"¹ the work of Aristocles: monument to Aristion. Drawn by G. Rehlender, from the plaster cast in the Royal Museum at Berlin.

¹ This monument is falsely named. It belongs to a period at least thirty years before the Persian wars. — ED.

learned, too, that a Spartan army had already reached by forced marches the Attic border, he gave up the expedition, and led his fleet back to Asiatic ports.

The Athenians had a right to be proud of their victory. They had risked a battle at a time of general despondency, in the face of the scenes at Eretria and the uncertain attitude of Sparta. For the first time since Persians and Hellenes had met in arms, a Greek army had not only withstood the Persians, but even made the attack, and driven a much larger force from the field. This victory Athens had won with her own resources, aided by Plataea alone. It was an honorable conflict, in which neither treachery nor mere good fortune had had any share. The genius of Miltiades, the skill of the other leaders, and the noble spirit of the troops, had won this glorious success. From this time Athens was regarded as the mainstay in all national resistance to foreign invasion.

There could be no doubt that the conflict had not been ended by the battle of Marathon. This defeat, which the Persians might consider only a mischance, was more than counterbalanced by the fact that the Persian flag was dominant up to the very coast of Attica. King Darius was not the man to overlook this disgrace to Persian arms, and he made without delay every preparation in order to secure for the Persian army in a new conflict every chance of success.

Unfortunately the Greeks did not even now energetically organize for the common defence. Indeed, soon after the battle of Marathon, scenes were enacted in Athens and Sparta which boded no good for the future. Miltiades sought to extend the power of the Athenians over the Cyclades, in order the better to ward off new attacks. But when, after a series of successes, he was obliged to return (489 B.C) from Paros unsuccessful and badly wounded, Xanthippus, a bitter enemy of Miltiades's house, took advantage of the ill feeling of the commons against him, and accused him before the Ecclesia of betraying the people with empty promises. Only the recollection of Marathon saved him from the death sentence. But the fine of fifty talents imposed upon him ruined his property; and his family might thank the gods when he soon after died of his wound.

In Sparta the ex-king Demaratus, who had been deposed shortly before the battle of Marathon, betook himself, thirsting for revenge, to the king of Persia. King Cleomenes, who was convicted of bribery in connection with an utterance of the Delphic oracle, which had induced the Aeginetans to give the ten hostages to the Athenians, met

with a violent death, "by his own hand," as it was officially announced. But even under these circumstances the Aeginetans did not get back their hostages that had been delivered by the Spartans to the Athenians. In retaliation they now surprised and captured a number of distinguished Athenians, who were going by water to Sunium to a festival of Poseidon. Still the Athenians would not restore the Aeginetan hostages. The war was renewed against Aegina in 488. An attempt to overthrow the oligarchic government on the island failed; and full 700 democrats were executed by the patricians. A great naval victory won the following day by the Attic fleet over the Aeginetans was the introduction to a fierce war of extermination between the two states.

But pitiable and repulsive as these things appear on the background of the danger from Persia, all was not hopeless. In Sparta Leonidas, step-brother of Cleomenes, one of the purest figures of Laconian history, had ascended the throne. In Athens a gifted statesman now came to the front, who recognized clearly the whole magnitude of the danger that threatened from Susa, and who understood how to forge in the furnace of the Aeginetan war the weapons for the deliverance of Greece. It was Themistocles. When, in 487, a dangerous revolt of the Egyptians unexpectedly compelled the Persian monarch to turn all his forces toward the Nile, the great Athenian no longer hesitated to take full advantage of this last respite for his people. The natural fitness of Attica for the rôle of a great naval power led him to conceive the idea of throwing the whole strength of his country upon the sea. He considered it possible to create an Attic naval force which could hold perhaps the sea against the Persian, and could at least throw great obstacles in the way of the enemy's fleet. Though at that time Athens, Aegina, and Corinth together furnished only 220 ships of war, Themistocles proposed, by drawing largely on the fourth class of the Athenian citizens for naval service, to increase the Attic fleet to 200 ships of the line. He shrewdly took advantage of the fury of the people against Aegina, in order to win the commons for his plan. He first proposed, in 487, the building of twenty triremes, and repeated this proposal from year to year. To meet these expenses, as well as others sure to follow for new wharves, ship-houses, and harbor improvements, he persuaded the senate and assembly to appropriate for the construction of the fleet the revenue from the silver mines of Laurium.

Meanwhile the revolt of the Egyptians collapsed. Darius died in B.C. 485. His successor, Xerxes, now thirty-five years old, after the final subjection of the Egyptians (484), began preparations against Greece

on a scale hitherto unknown. It became more and more necessary that Athens should have one leader, and an end should be put to party strife. Nothing was left but to appeal to the ostracism; and, fortunately for the welfare of Athens, the majority of the commons decided (in the spring 483) that the noblest citizen, Aristides, should for the present give way to the great statesman who alone was able to lead the Hellenes through the fearful dangers of the near future. Themistocles, the opposition of Aristides now being removed, thoroughly organized the navy. The crews of the warships were provided for by the state; the fitting out of the triremes was laid as a duty upon all citizens whose wealth exceeded a certain amount. The naval service of the Thetes was definitely regulated, as also that of the hoplites as marines. And while the fleet, to which from B.C. 483 until the outbreak of the war a hundred new ships were added, was schooled in the feud with Aegina, Themistocles pushed forward the harbor constructions and the fortifications begun in 493 at Piraeus. Still, nothing was quite ready when the great catastrophe burst upon Greece.

It was hoped that at this crisis help might come from the great Hellenic cities of Sicily, — Syracuse, then at the summit of its power under the celebrated Gelon, who ruled over a vast tract in the interior of the island, and could put 60,000 heavy-armed men in the field; and Agrigentum, whose ruler, Theron, was on terms of close alliance with Gelon. Unfortunately the offer of assistance which Gelon at first made was accompanied with the demand, to which the Greeks hesitated to accede, that the supreme command of their forces should be intrusted to him. Before this difficulty could be settled the Carthaginians, acting, doubtless, on a secret understanding with Persia, declared war on Syracuse and Agrigentum, and kept both cities so fully occupied that they had neither ships nor men to spare.

From the year B.C. 483 it was evident to the Greeks that the storm was drawing near; likewise that Xerxes was making every preparation to follow the old plan of campaign of Mardonius. To avoid the dangerous voyage around Mt. Athos, Phoenicians from the station at Elaeus, and the dwellers on the mountain, were cutting a canal through the isthmus which connects the peninsula with the Chalcidian mainland. Already preparations were made to bridge the Hellespont; the highways from the Hellespont to Macedonia were put in good condition; great magazines established in Sardis and at all stations from Doriscus to Tempe. Greece seemed to be indeed lost when it was reported how great forces were assembling in the summer of 481, from all the interior

of Asia, at Critalla in Cappadocia. Here Xerxes himself appeared toward the autumn of the same year, and led the army into winter-quarters at Sardis.

In Greece everything was still unprepared. The Spartans especially had done nothing at all. The noble sacrifice of two young men, Spertius and Bulis, who went of their own accord to Susa to offer themselves in expiation of the murder of the heralds in Sparta in 491, was not accepted by the Great King. Themistocles now proposed to organize at the last moment a Pan-Hellenic league against Persia. At the suggestion of Athens, Sparta, toward autumn of 481, summoned a federal council of the Greek states that proposed to resist the Persians, to meet on the isthmus of Corinth. Only ambassadors from Sparta and her confederacy, and from Aegina, Athens, Plataea, and Thespiæ came. On motion of Themistocles and of Chileus of Tegea, all feuds then existing in Greece, especially the war between Athens and Aegina, were settled. As soon as the arrival of Xerxes in Sardis was reported, ambassadors were sent into all the states of Greece to persuade them to take part in the war. But fear of Persia restrained many communities. Still worse, old neighborhood feuds or selfish party interests caused some Greek states to declare for the foreign enemy. And, far worse, the oracle of Delphi lost its senses and its courage, and by its oracles spread discouragement everywhere. The Cretans and the Peloponnesian Achæans remained neutral. The Argives, in their hatred against Sparta, made their adhesion to the Greek cause dependent on impossible conditions. The situation was critical in northern and central Greece. The most of the Thessalian nobility were patriotic, and resolved to fight; but the Aleuadae openly declared for Xerxes. The mass of the Theban patricians, in their hatred for Athens, were only waiting for the proper moment to go over to the Persians. Coreÿra made fine promises, but afterwards temporized, and avoided taking part in the war.

In the spring of 480 B.C. Xerxes set his gigantic army in motion against Europe. Bridges of boats had been built, as soon as navigation opened, at Sestos and Abydos. The Persian heralds set forward to demand once more from all the Greeks, except Sparta and Athens, "earth and water" for the Great King. At the beginning of April the Asiatic army and navy were ready for war,—the fleet collected in the harbors of Cyme and Phocæa, the army cantoned about Sardis. Toward the middle of April, the Great King broke camp and marched to Abydos, where from an eminence on the shore he re-

viewed his army and fleet. Seven days and seven nights the army was marching across the Hellespont. According to a recent estimate, the land army consisted probably of 800,000 men, 80,000 of these being cavalry. The fleet of 1207 war-ships carried 36,000 Persian, Median, and Sacian marines. Their crews numbered 250,000 men, while that of the 3000 transports numbered 150,000. The camp followers are estimated at 200,000. The land army — except the guard — was divided into fighting divisions of 10,000 men. For the march, it was arranged in three great columns, each consisting of two army corps. The left wing marched nearest to the coast under the command of the princes Masistes and Mardonius. The centre, with which was Xerxes himself, was led by the Achaemenide Smerdomenes and the aged Megabyzus. The right wing, under Gergis and Tritantaechmes, was farthest in the interior. To each of these great masses belonged its proportion of the cavalry. Under the commanders of the six great corps, and of the three cavalry divisions, were numerous sub-commanders, always Iranians, partly members of the house of the Achaemenidae, partly satraps of the provinces that furnished the contingents. The fleet of war-ships was furnished by the eight maritime nations of the empire, and the land army had been levied from sixty-one different peoples. Egypt furnished two hundred ships, Phoenicia three hundred, the flower of the fleet. The rest came from Cilicia, Pamphylia, Lycia, Caria, Cyprus, and about three hundred from the Greek ports of the empire. The admiral was Achaemenes, a brother of the king. The fleet was divided into four great divisions of about three hundred sail each. The first, the Egyptians, was led by the admiral himself; the second, the Phoenicians, by the Persian Prexaspes; the third, the Ionio-Carian, by Ariabignes, half-brother of Xerxes; the fourth, consisting of all the remaining contingents, by the Persian Megabazus.

From the beginning of June, 480, the Asiatic hordes rolled ceaselessly on against Greece. Early in July they reached Therma (the later Thessalonica) in Macedonia, where they were rejoined by the fleet, to which 120 new ships had been added. The narrow way along the banks of the Peneus, through the celebrated vale of Tempe, did not suffice for the passage of the vast host, re-enforced now by about 100,000 Thracian and Macedonian militia. It was necessary to prepare also the western pass across Olympus into the Peneus basin. Alexander I. of Macedonia secured for the Persians undisputed entrance into Thessaly through both these passes.

The small number of the Hellenes, who had determined with Sparta

and Athens to risk a conflict, were obliged to govern their movements by those of the immensely greater Persian force. The Hellenic nation numbered, indeed, at this time of its full vigor, perhaps more than twenty millions. But of these more than a third were subjects of the Great King; the Italiote and Siceliote third could not be counted on; and of the rest, hardly the half was resolved on resistance. Unfortunately, even the Peloponnese, whose population, including the Argives and Achaeans, is reckoned at two millions, was not inclined to meet the Persians at so remote a point as Olympus. The result was half measures, which in war are always ineffective. When the news that the Persians had left Sardis reached Corinth, the Isthmian congress reluctantly determined, on the appeal of the Thessalian nobility, to occupy Olympus. But only Themistocles voted to advance the fleet also to the Thermaic Gulf; and only 10,000 men, Peloponnesians and Athenians, were sent under Euaenetus the Spartan and Themistocles, early in May, to occupy the pass of Tempe. There they were joined by the Thessalian contingents. But there was danger that they might be outflanked by the Persian fleet. Behind them the Perrhaebians, Magnetes, Dolopes, the Dorians on Parnassus, Aenianes, and Malians promised submission to the Persian heralds. The loyalty of the Opuntian Locrians and of the Boeotians (except of Thespieae and Plataea) was suspected. Besides, Alexander of Macedonia, playing a double part, not only gave them accurate information of the strength of the Persians, but showed them that their position at Tempe could be outflanked by several western passes. When the Greeks, accordingly, at the end of May determined to leave this point without a contest, the Thessalians and the Achaeans of Phthiotis went over to the Persians.

Fortunately the Greek statesmen on the Isthmus still held out. The Delphic oracles, which were manifestly intended to discourage the Spartans and Athenians, failed in their object. For Athens the celebrated oracle which bade the people rely upon "the wooden castle of Tritogenia," was finally fulfilled. Themistocles's cleverness recognized therein the new fleet, — a view in which he was supported by the official soothsayers, and to which he was able to win the people.

As the Persians came nearer, the congress determined to defend, with all their might, Thermopylae, the chief entrance to central Greece. At this point the fleet could co-operate with the land army; and the nature of the mountains and of the adjacent parts of the sea kept the Persians from using their superior power with effect. Here a narrow pass, connecting the valley of the Sperchius with eastern Locris, leads

between the swampy shores of the Malian Gulf and the lofty and precipitous cliffs of Oeta (Fig. 130). The place has been completely changed by alluvial deposits. The pass, now a league in breadth, can be effectually defended only by artillery. But at that time it was in several places only wide enough for one wagon to pass, and hence could be easily held by a moderate force. The narrowness of the strait between Euboea and the mainland would in like manner help to neutralize the numerical superiority of the Persian fleet. But, unfortunately, the jealousy of the Peloponnesians toward Athens, and the short-sighted policy of the Spartan government, hindered the effectual defence of this



FIG. 130. — Thermopylae and vicinity.

incomparable position. The Corinthians looked with envy on Athens's maritime glory, and, with the Aeginetans, refused to make a naval fight under Attic command. But Themistocles was able to induce his patriotic countrymen, for the sake of the general interest, to put themselves under the supreme command of Sparta. Now, however, Sparta was not willing to risk anything on land. Mount Oeta, occupied by 40,000 men, would have been invincible. But, instead of this, the ephors, on the pretext of the Olympic games, kept the mass of the Peloponnesians within the Isthmus, which they had fortified, and sent finally to Thermopylae only 4100 Peloponnesian hoplites, among them 300 Spartans and 1000 Perioeci, with the corresponding number of helots and slaves. The rest of the troops were, it was promised, to follow soon.

When the congress learned that since the beginning of July the Asiatics had covered southern Macedonia, the Greek fleet moved northward. Under the command of the Spartan Eurybiades there were collected at Cape Artemisium, the northeast point of Euboea, 147 Attic war-ships commanded by Themistocles, besides 113 Peloponnesian vessels, and those of smaller communities. The Peloponnesian land troops were led by King Leonidas of Sparta. He was re-enforced by 700 hoplites from Thespieae, 400 Theban warriors of anti-Persian sentiments, 1000 Locrians, and 1000 Phocians. With only 7200 hoplites, therefore, he was to hold Thermopylae against a million men; and even of these the Phocian battalion had to be sent to guard a mountain path which led around the pass.

Early in August the Persians entered Thessaly, where they received considerable re-enforcements. Ten days after Xerxes's departure, Achaemenes also left the Gulf of Therma with his fleet, but lost on the rocky coast of Magnesia, in a three-days' hurricane from the northeast, fully 400 vessels, 200 of them war-ships. This news raised the sinking courage of the Greek seamen. Achaemenes repaired his fleet, still numbering 1100 sails, in the harbor of Aphetæ in the Pagasaean Gulf. He then despatched 200 ships around Euboea, and was manoeuvring the remainder in the narrow sound between Aphetæ and Artemisium. Here the Greeks, by the advice of Themistocles, made an onset on the Persian fleet. The battle was undecided, but the skill of the Greeks at sea was proved. Re-enforced next morning by 53 Athenian ships, and learning that the Persian squadron that had been sent round Euboea had been completely destroyed by a storm in the straits near Cape Geraestus, they risked a second, and this time very successful, attack upon the Asiatic fleet.

The second day at Artemisium was also the first day of hot conflict at Thermopylae. When Xerxes arrived at Trachis, he began, after four days' hesitation, the attack on Thermopylae. But Leonidas's resistance was as successful as it was skilful and brave. All the assaults of the Persians proved unavailing against his tactics, the bravery of the Greeks, and the superiority of Greek heavy armor in a hand-to-hand conflict. The Persians suffered great losses. But it soon became evident that with the great numerical superiority of the Persians, the Greeks, who, shameful to say, received no re-enforcements from the Isthmus, while they suffered considerable losses from the Persian arrows and sabres, would be gradually worn out by the ceaseless fighting. But the catastrophe came still more speedily in another way.

On the day after this first battle at Thermopylae, Achaemenes made a heavy attack with 900 vessels upon the 300 Greek ships that were still seaworthy. He did not conquer the Greeks, it is true; but the latter suffered such losses that they determined to withdraw southward. As they were making preparations to withdraw, a boat brought news from Thermopylae that Leonidas was dead, and that the pass had been that very day taken by storm by the Persians. On the day of the last battle at Artemisium, Xerxes had made one more assault upon the pass, but in vain. He was already beside himself with anger and shame, when treachery in the ranks of the Greeks came to his aid. The Malian, Epialtes, informed him of a mountain path, little used, but practicable, by which Oeta could be passed and Thermopylae flanked. As soon as night came, Hydarnes was sent thither with 30,000 men under the guidance of Epialtes, and through the negligence and lack of courage of the Phocian guard was able to pass over without difficulty. Leonidas learned during the night from some Greeks in the Persian army of the impending calamity. When at break of day the news came that Hydarnes had reached the summit of the mountain, and in a few hours would be in the valley, the hero formed his patriotic resolution. To attempt to hold out against both Xerxes and Hydarnes could only result in the destruction of the whole army. The same result was inevitable if they should now abandon Thermopylae, and be overtaken by the Persians on the retreat. So Leonidas decided to send away the majority of the Greeks without delay, while he himself, with a small rear-guard, would defend the pass to the death. The 300 Spartans, therefore, the Thebans of their own accord, the Thespians, and the Mycenaean, all together not more than 1000 hoplites with the corresponding number of slaves, remained. Leonidas marched about ten in the morning with his little band against the advancing columns of Xerxes, and inflicted great losses on them. Finally the hero fell. The news now came that Hydarnes had reached the inner side of the pass; and the Greeks withdrew into an old Phocian fortification within the pass, behind whose walls they fought till the last man was cut down. Of the Greeks about 4000 in all had been killed, 2000 in the last day's battle; of the Asiatics, perhaps 20,000.

The news of the death of Leonidas caused the Greek fleet to retreat immediately toward the Saronic Gulf. Achaemenes put himself immediately in connection with Xerxes at Thermopylae. The brave resistance of the Hellenes had had a very depressing effect on the Persian commanders. When, therefore, Demaratus, the Spartan exile, gave them

the shrewd advice to divide the fleet, and with a detachment attack the Peloponnese from the south, in order to cause the army on the Isthmus to disband, Achaemenes would not hear to it. He was unwilling to meet the Greek fleet again unless with an immensely superior force, and insisted that the whole naval force should continue to operate in conjunction with the land army. Xerxes yielded to his wishes, and army and fleet again moved slowly southward. All of the eastern part of central Greece fell immediately, without a struggle, into the hands of the Persians. Only the Phocians still adhered to the Greek cause. While their territory was ravaged, they withdrew to the high mountains. Boeotia, under the lead of the Theban knights, went over to the Persians. The towns of Thespieae and Plataea, which were abandoned by their inhabitants, were burned. The Persians now overflowed Attica, meeting for the present no resistance.

When the Greek fleet reached Attic waters and sailed, part into Phalerum, part into the Strait of Salamis, the Athenians learned with sorrow that the Peloponnesians had given up the states north of the Isthmus. Under these circumstances Themistocles, strongly supported by the aristocratic-conservative party, especially by the Areopagus and Cimon, son of Miltiades, induced the whole people to abandon the land, and rest all their hopes on the fleet. The whole non-combatant population left their homes without delay, and went for safety to Salamis, Aegina, and Troezen. All who were capable of bearing arms joined the crews of the fleet. Only a few hundred elderly Athenians of the poorer class remained in Athens, to defend the Acropolis, to which they supposed the 'wooden walls' of the oracle referred. Party differences were forgotten: Aristides was recalled from exile; and all prepared, with one spirit, to fight for their common country.

The Greek fleet now united again in the strait between Attica and Salamis, this time considerably strengthened by re-enforcements from various Peloponnesian ports. We know also that at least one ship was sent by the Italian Croton. But, even now, many vessels were, from local motives, detained at home, which should have been sent to Eurybiades. The strongest part of the fleet was the Attic contingent of two hundred sails, with crews numbering from thirty-two thousand to thirty-six thousand men. Altogether three hundred and seventy-eight triremes were to oppose nine hundred Asiatic warships. But to the horror of the Athenians, Megarians, and Aeginetans, the Peloponnesian captains now proposed to withdraw to the Isthmus, and there array the fleet under the eyes of the land army. Themistocles was not

willing to abandon Attica, Aegina, and Megara without a battle, still less to lose the advantages offered by the narrow Strait of Salamis, for a decisive battle with the Persian fleet. He used, therefore, every means to dissuade the admiral Eurybiades from the false step. But when the Persians had overrun Attica, occupied Athens, stormed the Acropolis, set fire to the sanctuaries and the greater part of the city, and from Salamis the flames were seen which consumed the ancient city of Cecrops, most of the captains voted to sail away the next morning. Eurybiades and the majority of the council of war were induced, however, partly by persuasion, partly by a threat that the Attic fleet would withdraw to Italy, to reverse the resolution, and remain. But when, in the course of the day, the Persian fleet, prepared for battle, sailed out from Phalerum in long ranks; when it was observed that Xerxes, after holding a great council of war at Phalerum, had occupied the Attic shore of the Strait of Salamis with his land-army, the courage of most of the Peloponnesians again sank; and, in a new council, the majority of the leaders voted for the now especially hazardous step of withdrawing early the next morning to Cenchreae. At this most critical moment, Themistocles resorted to desperate measures, in order to force them to accept battle at this point. He sent during the night, by his faithful slave Sicinnus, a native Persian, to the king at Phalerum, a secret message that the general of the Athenians was well-disposed to the Persians, and therefore informed the Great King that the Greeks were about to flee. This the Persians ought not to allow, and could easily prevent; for among the Greeks open discord prevailed, and there was scarcely a thought of resistance. The Persians had no reason to doubt the correctness of this information. As the suggestion of Themistocles agreed exactly with the plans of Xerxes, the latter gave immediately the necessary orders. The island Psyttalea, between the southeast point of Salamis and the Attic shore, was occupied with picked Persian warriors; the bulk of the Persians pushed forward about midnight to close the strait between the Attic Munichia, and Cape Cynosura, on Salamis, and two hundred ships were detached to close the western entrance of the strait at Eleusis. The Greek captains were informed of these measures soon after midnight, and prepared for the now inevitable struggle. Even among the Peloponnesians there was now no longer any thought but of resistance to the last man.

On the morning of September 20 (B.C. 480), the Hellenes found the Persian fleet arrayed in a half-circle round them. The Phoenician division, forming the right wing, was stationed in front of the Attic

coast, with its right point extending over to Salamis. The centre, consisting of Cyprian, Cilician, Lycian, Pamphylian, and Egyptian ships, and led by the admiral, was stationed opposite the town of Salamis, touching the Attic cape Aegaleum, on which was Xerxes, surrounded by scribes, who were to record on the spot the glorious deeds of his fleet. The left wing—the Ionio-Carian squadrons of Ariabignes—closed the eastern outlet of the strait and extended to the Piræus. At the commencement of the desperate conflict, which the Greeks, with about three hundred and eighty ships and seventy thousand men, undertook against the nine hundred sail and one hundred and eighty thousand men of the Asiatics, Aristides remained behind with a part of the Attic hoplites, to cover Salamis. Themistocles and the Attic ships were to hold the left wing against the Phoenicians and Cyprians, the smaller squadrons in the centre to oppose Achaemenes, and Eurybiades, with the Megarians, Corinthians, and Aeginetans, to hold the right wing against Ariabignes. Not long after dawn, single conflicts occurred on both wings; but the fight soon became general. As the Ionian seamen on the Persian left wing stubbornly opposed the Dorian squadrons of the Greek right, the latter, especially the Aeginetans, were for a long time in a difficult situation. The turning-point of the battle was the manoeuvre of Themistocles on the left wing. After he had broken through the Phoenician and Cyprian squadrons, whose commanders partly ran their ships on the Attic shore, partly took refuge behind the line of the Persian centre, the Athenians formed a new front, by turning to the right, and arranging their ships diagonally across the strait, facing southeast. Then Themistocles flung himself upon the open right flank of the enemy's centre, and drove the Asiatics down the strait, to whom, with their vast numbers, the narrowness of the channel became more and more dangerous. The Athenians and the Aeginetans together struck the last blow against the Ionio-Carian division, which, after a hard struggle and the death of Ariabignes, gave way. The victory was made complete by Aristides and the hoplites, who stormed Psyttalea, and put to death the picked Persian force stationed there.

In this battle the Greek loss was 40 ships; that of the Persians, more than 200 ships, and 50,000 men. But the situation was still critical. Everything depended upon the character and ability of Xerxes. His land army was unbroken; and his fleet was still, in numbers at least, far superior to the Greek. But the king was not equal to the situation. He lacked insight, fertility of invention, calmness, resolution, and perseverance under adversity. The great reverse which his fleet had

met with robbed him of all self-reliance. After some wavering he decided not to make another trial with the fleet. The ships were only to provide supplies, and keep open the connection with Asia. But he proposed to advance with the land army against the Isthmus. Here again, however, he was deceived by the cunning of Themistocles. The proposal of the great Athenian to press forward with the victorious fleet against the bridges on the Hellespont had found no response among the other leaders of the fleet. Themistocles, however, sent word secretly to Xerxes, that in the interest of the Persians he was holding back the Greeks, who wished to push after the Persian fleet and destroy the bridges; the king could therefore quietly take his departure. It is certain that Xerxes did consider this most vulnerable point of his line of retreat to be in danger, and actually changed his whole plan of war. He gave up the attack on the Isthmus, and decided that the best part of the army, 250,000 picked Iranians, under Mardonius, should winter in northern Greece, and renew the war the next year. The bulk of the army Xerxes himself led back to Asia; but Artabazus was to return from the Hellespont to Mardonius with 60,000 Medes. The Persians reached the Hellespont about the middle of November, 480. Hunger, pestilence, and disorder had decimated their ranks before they reached Sestos. Here they found that the bridges of boats had been destroyed by a storm, and they were conveyed across by the fleet. Xerxes led his army into winter quarters at Sardis, and remained there himself for sometime, and then made preparations to renew the war.

The Greek fleet meanwhile followed the Persian only as far as Andros, and sailed thence to the Isthmus, where the congress was still in session. The jealousy of the several Greek cities and leaders with regard to the prize of victory, and the insults offered to Themistocles, proved very clearly that even the necessity of this war could not change the character of the Greeks. Only the Spartans had the good sense to grant Themistocles the honors he had merited. For the year B.C. 479 Aristides was put in command of the Athenian army, and Xanthippus of the fleet.

The confidence of the Greeks was strengthened by the news of the brilliant success of the Greeks of Sicily. If Gelon had coupled his offer to assist the mother-country against Persia with impossible conditions, he fought none the less with skill and energy against the Carthaginians. Perceiving their preparations, he and Theron of Agrigentum made haste to get their forces ready. The Sicilian Greeks shared the

determination of their leaders. Gelon's queen, Damarete, daughter of Theron, sacrificed her ornaments to raise money for the war; and the women of Syracuse hastened to follow her patriotic example. Finally, in the summer of 480, a Carthaginian fleet of 3000 transports, convoyed by 200 war-ships, landed at Panormus an army reported at 300,000 men, under Hamilcar of the great house of Mago. This army immediately took up a fortified position near Himera, and attacked the city. Gelon advanced to its succor with 50,000 infantry and 5000 cavalry, fortified a camp southeast of Himera, opened connection with

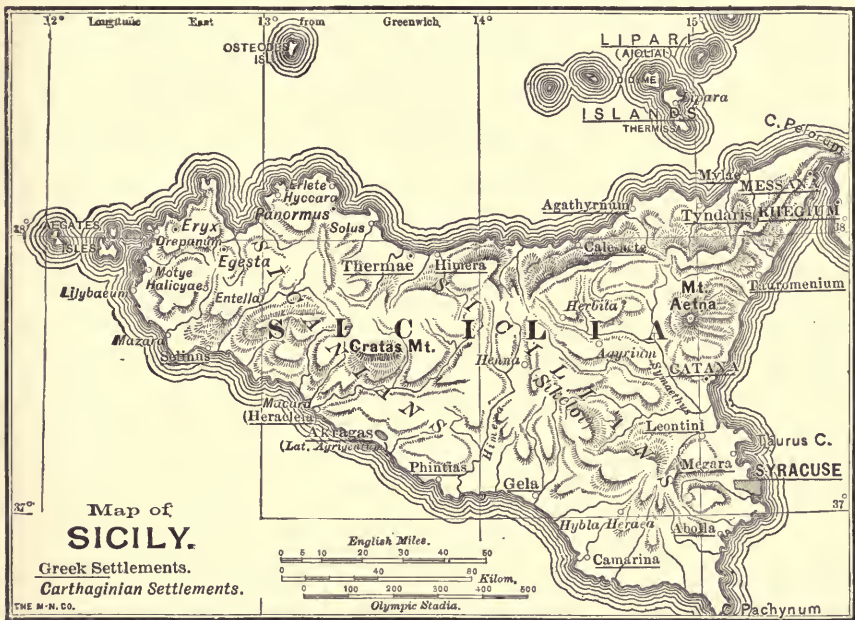

FIG. 131.

the city from this point, and began the combat against the roving bands of Carthaginians, whose main body lay to the west of Himera. Learning that Hamilcar was expecting cavalry from the Selinuntians, Gelon caused a part of his own horsemen to go over to the Carthaginians, pretending that they were the troops from Selinus. As soon as he was sure that his cavalry had been admitted without suspicion into the camp of the Carthaginians, he made a violent onset on the Punic position. The combat was long doubtful. Finally Gelon's cavalry, from Hamilcar's camp, succeeded in firing the fleet, and thereby demoralizing the army. Hamilcar threw himself in despair into a sacrificial fire, in order to propitiate by his own death the anger of the

gods against his people. The Carthaginians were completely defeated, their transport fleet had gone for supplies, and of the war-ships the fleeing troops were able to save only twenty, on which to escape. The Carthaginian army was partly cut down or forced to surrender, partly fled to Selinus. This battle took place, according to the statements of the Greeks, either at the time of the third day's conflict at Thermopylae, or on the day of Salamis. Gelon, knowing the power of Carthage made a moderate use of his successes. Content with his victory, he avoided inciting the Carthaginians to a life and death struggle. He granted them immediately the peace they asked for, demanding only the payment of a war indemnity of two thousand talents. He then so skilfully turned to his own advantage the joy of the Syracusans over the victory, that he was jubilantly proclaimed king by the popular assembly.

In Greece proper the campaign of 479 was at first sadly like that of the preceding year. The Greek contingents had all gone home in the fall of 480. It occurred to nobody, least of all to the Spartans, to follow the Persians to Boeotia, and assault them there. The attack and the plan of campaign were left to the Persians, who were again making vigorous preparations. Xerxes wintered 400 ships, among these the Ionic, in the harbors of Cyme and Samos. At this island the fleet under Artayntes assembled in early spring, and the marines were re-enforced. These forces, supported by 100,000 men at Sardis, and 60,000 men under Masistes and Tigranes at Miletus, were to guard the west coast of Asia Minor. The less efficient parts of the land army were sent home. Artabazus, with his 60,000 Medes, joined Mardonius in Thessaly in the summer of 479, having put down a revolt of Olynthus on his march from the Hellespont. He found Mardonius actively preparing for the conquest of Greece, which was to be his future satrapy. Mardonius was making especial efforts to bring over certain cities by negotiation. It was easy to win over Argos to his interests. But he was especially anxious that the Athenians, who after the battle of Salamis had quickly established themselves again in their own land, should, if possible, be drawn away from the Greek cause, or at least persuaded to make a separate peace. Alexander of Macedon was to treat for him with the Athenian Boulé. But the loyal Boulé did not enter into negotiations with him until the arrival of the Spartan ambassadors, who had been hastily despatched as soon as the news came. When now Alexander proposed, in the name of Mardonius, to the Athenian Ecclesia full amnesty, freedom and independence, as well as

the restoration of their temples, in case they would give up the hopeless contest against the Great King, and conclude peace and a firm alliance with Persia, the Spartans were disturbed; for they knew that the policy of their government toward the Athenians had not been hitherto such as to call for gratitude from the latter. Convinced that the Peloponnesians would be in the greatest danger if the Athenians abandoned the Greek cause, the Spartan ambassadors entreated them not to accept Persia's proposals, and promised to provide, during the rest of the war, support for the women, children, and aged of the Attic people. The Athenians patriotically declined the Persian proposal; and the famous proposition of Aristides was adopted: "We will fight as long as we can, and make no treaty with the barbarians. So long as the sun does not change his course, the Athenians will make no compact with Xerxes. They will defend themselves against him, trusting to the help of the gods and heroes whose temples and images he has wantonly destroyed. And whoever shall in future treat with the Persians, and abandon the Greek alliance, him let the Eumolpidae exclude from the mysteries of Demeter, upon him let the priests lay their curse!"

The Spartans thereupon promised immediate aid to the Athenians. But even this time Sparta did not keep her word. Strong Peloponnesian forces had been assembling on the Isthmus since spring; but Cleombrotus, their leader, brother of Leonidas, did not advance beyond the fortifications. Under these circumstances the Greek fleet also, 110 triremes (sixty of them Athenian, under Xanthippus), led by the energetic King Leotychides, remained at the island of Delos. So July came on. Mardonius and Artabazus, re-enforced by Macedonian and Thessalian troops, and commanding more than 300,000 men, had already passed Thermopylae, while from the Isthmus came the startling news that the miserable Cleombrotus, frightened by an eclipse of the sun, which came on as he was offering sacrifices with a view to marching out, had left the Peloponnesian army, and returned to Sparta. The Athenians had to take refuge again partly on Salamis, partly on the ships lying in the Piraeus. Meanwhile Mardonius advanced without delay through Boeotia, whose warriors willingly joined him, and reached Athens in the middle of July, just after the Athenians had left. Still he spared the home of his most resolute foes, who had been so basely forsaken by the Peloponnesians. He hoped to win over the Athenians, and he renewed his former proposals on somewhat more favorable terms. But still the Boulé, now at Salamis, declined the Persian offers. The only Athenian councillor who dared to urge ac-

ceptance, Lycidas by name, was murdered by the incensed citizens, while the women tore to pieces his wife and children. The fidelity of the Athenians seems the more astonishing when compared with the conduct of the Spartans. Immediately after the departure of Mardonius from Larissa, in Thessaly, the Boulé had, on Aristides's proposal, sent Cimon and Myronides, in company with some Megarians and Plataeans, to Sparta to request speedy help; but the ephors detained them ten days without giving the desired answer. The Athenians on Salamis saw with the more exasperation their land utterly laid waste by the Persian general. But at last they heard with astonishment that the Persians were departing in all haste. They learned afterwards that Mardonius had received news from Argos that the whole Spartan army had started northward. The noble Chileus of Tegea, who was influential in Sparta, had warned the ephors not to carry their ambiguous policy too far, lest the Athenians might be driven over to the Persians, and great harm result to the Peloponnesians. The ephors followed his advice, and despatched five thousand hoplites that very night. The next morning, when the Athenian envoys demanded an answer to their reiterated request, they made a joke of the matter, and announced to them that the troops were gone.

The gifted Pausanias, son of Cleombrotus, received the chief command, and matters were pushed with more energy. While Mardonius abandoned Attica, in order to avoid fighting in the devastated land, and to be near his sources of supplies at Thebes, Pausanias hastened to the Isthmus, where the Peloponnesians assembled in great numbers. Still, it was the beginning of September, 479, before he ventured to leave the Isthmus. He had now 27,000 excellent Peloponnesian hoplites, about 10,000 of whom were from Laconia (Perioeci and Spartans). The smaller contingents from other states swelled the number to 30,000 hoplites. Besides, there were 40,000 Helots, armed in part as slingers, and 20,000 slaves. When Pausanias reached the ruins of Eleusis, Aristides joined him from Salamis with 8000 Attic hoplites, with the necessary attendants, and 800 archers. The whole army now consisted of 110,000 men, — 38,700 hoplites, the rest (including 1800 Thespians) light-armed troops. This was the mightiest army that the Greeks alone ever put into the field, the most numerous ever led by a Greek commander before Alexander's Indian expedition.

From Eleusis, Pausanias crossed Cithaeron by the pass of Dryoscephalæ; and from the heights above the Boeotian towns of Hysiae and Erythrae, the Hellenes observed below them, on both sides of the

Asopus, the Persian army, perhaps, including its Greek contingents, 350,000 strong. On the heights back of the river, Mardonius had built an immense fortification, about ten furlongs square, with palisades, wooden towers, and walls of wooden beams. At the sight of the Persians the Greeks took up a strong position on the spurs of Cithaeron, fronting the northwest, in such a way that their left wing, the Athenians, covered the line of retreat to Eleusis and the provision-ships. Mardonius sought to come to battle as quickly as possible. He rejected the advice of the Thebans and Artabazus to pave the way by buying several Greek leaders, and trusted to his good sword alone. But the first considerable attack of Persian cavalry under Masistius met with ill success. This raised the courage of the Hellenes, for whom Pausanias, as the springs on Cithaeron did not suffice for his army, now sought a new position, in which the front was turned to the northeast. He first marched westward, then posted his right wing (Lacedaemonians and Tegeates) a league to the east of the ruins of Plataea, near the spring of Gargaphia, but he covered the Dryoscephalae insufficiently. More to the north, on a chain of hills stretching to the Asopus, stood the centre of the Greek army, composed of the smaller contingents, while the left wing, the Athenians, Plataeans, and Thespians, had the Asopus and a sacred grove of the Plataeans in their rear. When Mardonius observed the new position of the Hellenes, he hastened, by the advice of the Thebans, to put his whole army in battle array. On his left wing, opposite the Spartans, he placed the picked troops of the Persians; in the centre the Medes, Bactrians, Sacae, and Indians; on the right his European auxiliaries, opposite the Athenians. But he avoided conflict. The influence of Greek soothsayers had led to the belief in both camps that the sacrifices were favorable for a defensive battle. Thus eight days passed, not to the advantage of the Greeks, who were constantly annoyed while getting water at the Asopus by the Persian cavalry and bowmen. By the advice of the Thebans, Mardonius, in the night after the eighth day, cut off the Greeks from the pass by which they had come from Eleusis. Two anxious days were now passed by the Greeks in their very critical position.

At last Mardonius became impatient, and on the eleventh day declared to his council of war that he would next day force a battle. Pausanias, informed of the plan during the night by Alexander of Macedonia, who was serving with Mardonius, greatly increased the confidence of the Persians, by forthwith ordering the Athenians, the vic-

tors of Marathon, to the right wing to fight against the Persians, and bringing the Spartans to the Asopus. When Mardonius observed this the next morning, discerning the motive, he changed correspondingly the position of his own divisions, thereby causing Pausanias to restore the old arrangement, which then the Persians also did. The Persians then began a series of fierce assaults with their whole cavalry force, whose arrows and javelins greatly annoyed the hoplites. Still Pausanias would not risk a charge. When finally the Persian cavalry had filled up the fountain of Gargaphia, the Greek council of war determined on a retreat. It was proposed to withdraw in the night, half a league west-south-westward to the heights, take position on an island in the brook Oëroë, which flows into the Corinthian Gulf, and from here win the lost pass. But the centre now became so demoralized, that as soon as night came on they fled, rather than retreated, to Plataea itself. Pausanias observing this, and wishing to restore connection with them, commanded his right wing to march immediately to Oëroë. This was imperfectly carried out, and on the morning of the fourteenth day (near the end of September, B.C. 479) Pausanias found himself suddenly forced to accept battle under the greatest difficulties.

Pausanias had reached the brook Moloeis, and an ancient temple of Demeter, only half a league from his old position, but still a league from his centre encamped at Plataea. He was separated by a chain of hills from the Athenians, when he perceived the Persians close behind him. Mardonius, observing at dawn the departure of the Greeks, ordered his infantry to pursue, and pushed forward himself with the picked troops of the Persians after the Hellenes, with whom his cavalry was already engaged. Pausanias was now obliged to fight. He had at hand only 11,500 hoplites (Tegeates, Perioeci, and Spartans), and 41,500 attendants. He drew up his army with the left wing (Tegeates) resting on the brook Moloeis, while the temple of Demeter, from whose grove the Helots were to hurl their stones, protected the rear. As soon as Mardonius appeared with his troops, a body of mounted guardsmen at the head, he drew back the cavalry, and ordered the bowmen to pelt the Greeks with arrows. For the moment Pausanias was at a loss. While the Athenians on the left wing, 19,200 excellent troops, were a league to the north already in hot conflict with the right wing of the Persian army, where the Greek allies were posted, he lost some precious time waiting for favorable omens from the sacrifices, although the arrows of the Persians were telling

on his ranks. Finally, when the impatient Tegeates had begun to advance of their own accord, the omens became favorable, and Pausanias gave the order for a general advance with levelled spears. Spartan discipline, the fierce onset of the hardy warriors from Laconia and Arcadia, soon overthrew the picked troops of the Persians in spite of the bravest resistance. In vain did Mardonius hurl the Sacian cavalry upon the Greek slingers; in vain did he finally plunge himself with his mounted guard into the fight. Even the guard was soon hewn down; and when Mardonius himself was killed by the Spartan Aeimnestus, the rout was complete. The masses of the Persian left wing, and the now advancing columns of the centre, were driven in wild disorder to the plain of the Asopus. Here the Asiatic and Boeotian cavalry checked the pursuit; and the retreating bands of infantry took refuge in the great camp, behind whose palisades and block-house walls the archers for some time held in check the troops of Pausanias, including the centre, which had now come up from Plataea. The issue was still doubtful. The Boeotians, fighting stubbornly for their bad cause, were still hotly engaged with the Athenians. The Boeotian knights, who had helped to cover the retreat of the Persians to the fortifications, had succeeded in routing a remnant of the centre, 4000 hoplites from Phlius and Megara, with their attendants, who were marching in disorder toward the Asopus, and had killed six hundred. The bulk of the Asiatics could have been saved if Artabazus, the successor of Mardonius in command, had been a true man. As soon as he saw the beaten regiments flying before the Spartans toward the Asopus, he hastily retreated with his whole corps—40,000 men still intact, to whom large numbers of the defeated army immediately attached themselves—to Thermopylae, and then to the Hellespont. The heroic Athenians, after a long struggle, routed the Boeotian infantry, and after these had fled, under the protection of their cavalry, to Thebes, united with Pausanias in storming the fortified camp of the Asiatics. The defenders were cut down by myriads; only 3000 escaped. From the passage of the Dryoscephalae to the evening of this great day the Greeks had lost only 10,000 men, while of the Asiatics there fell on the day of Plataea alone 100,000 men. The exhaustion of the Greeks and the lack of cavalry made an effectual pursuit of the Persians impossible. (Figs. 132, 133).¹

¹ In the first of the fragments (Fig. 132 *a*) we see a Greek standing over a fallen Persian, and, with upraised shield, just storming forward to meet a Persian horseman. The latter carries at his left side a quiver, and swings with his right hand his weapon (broken



132 b.



132 a.

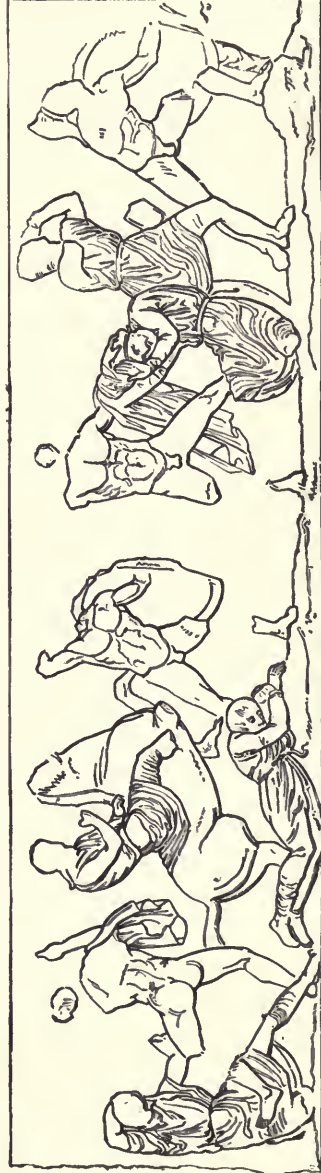

133.

FIGS. 132, 133. — Battle scenes between Greeks and Persians. Fragments from the frieze of the Temple of Victory at Athens. (British Museum.)

The Plataeans received from the allied Greeks the acknowledgment of their complete political independence, and the promise that they should be protected against all attempts upon their freedom. In perpetual remembrance of the day of deliverance, the festival of the Eleutheriae was established, which continued to be celebrated as late as the second century of the Roman Empire. Every year, on the anniversary of the battle, representatives of the allied Greeks were to celebrate the victory with thanksgiving at the temple of Zeus Eleutherius, which was now to be erected; and in every fifth year there were to be also games and distribution of prizes. But the Persian party in Thebes was to be immediately crushed. On the eleventh day after the battle the Hellenes besieged the city, and twenty days later, after the flight of Attaginus, the Persophile leader, the chiefs of his party were delivered up. Pausanias then led the army to the Isthmus, disbanded it toward the end of October, 479, and brought the Theban traitors before the court of the congress, who turned them over to the executioner.

The victory of Plataea forever put an end to Persian armed aggression on European soil. During the same time, and immediately afterwards, events occurred on the Ionian coast which seem already the beginning of the offensive warfare carried on by the Hellenes, during a long series of years, against the empire of the Achaemenidae. The Greek fleet lay inactive at Delos until the beginning of September, 479, when three ambassadors of the Samian commons appeared before Leotychides, and called upon him to come to Samos, and, with the help of the commons, overthrow their tyrant, and strike a blow at the Persian fleet anchored at the island. The commanders instantly agreed to the

off) against the Greeks. Next follows on foot a Persian, as may be recognized by his dress, half drawing back before a Greek, of whose round shield only a part remains. In the next piece (Fig. 132 *b*) the horse of another Persian pitches headlong over the body of a fallen friend. An Athenian pressing forward has seized the rider with his left hand, on which hangs his shield, and has almost dragged him from his horse, while a Persian footman from behind tries to support him. The third fragment (Fig. 133) shows in its first group a Persian, apparently wounded, sinking on his right knee. With his right arm he seeks to protect his head against the stroke of his antagonist, who is covered only with a short mantle, and who, pressing his left foot in his enemy's groin, has raised his arm for the death blow. The next group represents a Persian horseman in combat with a Greek on foot; before both of them a Persian lies dead. Then follows a Greek who has seized a bearded Asiatic by the hair; his right arm, which is broken off, swung a weapon to kill his unarmed antagonist. Behind this one, stands another Persian, who seems trying to assist his countryman. The last figure is a Greek in position to strike, with his left foot upon a stone. His antagonist is not visible.

[It is highly probable, though not certain, that these sculptures, though made several decades after the battle of Plataea, refer to this struggle.]—ED.

plan. Samos was admitted to the Greek alliance, and on the second day after the departure of the messengers Leotychides led his fleet eastward. But scarcely had the Persian admirals, who suspected the Ionians, observed his approach, when they left the harbor of Samos and sailed over to the promontory of Mycale, on the Asiatic coast. Here they sent the Phoenician ships home, and united with the troops of Tigranes and Masistes that were stationed on the coast. Near the camp of the Persian army the ships were drawn up on shore, and fortifications were then thrown around the ships and the camp of the sailors and of the army, and these again strengthened by a chain of palisades. Near Mycale were thus posted about 100,000 men, 60,000 of these tried warriors. Nevertheless, Leotychides, counting on the help of the Asiatic Greeks, dared to attack this imposing force, although he had only 3500 hoplites (2000 of them Athenians). He began by reconnoitring — on the day of Plataea, it is said — the enemy's position with his fleet, and cunningly contrived so to bring the Greeks in the Persian army into suspicion, that the Persian commanders disarmed the Samians, and sent the Milesians to guard the passes of Mycale. Leotychides then landed his little army, with the seamen, perhaps 10,000 men, east of the Persian position, and drew it up in battle array. His line faced west, the Athenians on the left, the Spartans on the right, the smaller contingents in the centre. It was late in the afternoon before Leotychides could give the signal to advance against the Persians, who were now drawn up east of their fortifications. While the right wing of the Greeks was going round an impassable ravine, the Athenians and the hoplites from Corinth, Sicyon, and Troezen had for a long time to sustain the conflict alone, and were able to advance only with difficulty and loss. When the Persians at last gave way, the Greeks pressed hotly after. In the camp itself the Samians revolted, and seized all the arms they could find; and soon the remainder of the Asiatic Greeks went over to the Athenians. Under these circumstances the brave regiments of the Persians could not long maintain the conflict; on the arrival of Leotychides, they gave way, and at nightfall retreated. The Persians lost on the field and in their flight about 40,000 men, besides the Ionian deserters; the rest of the army fled in complete disorder to Sardis.

The Greeks did not yet feel strong enough to assure the freedom of their kinsmen on the Asiatic mainland; but all the islands off the coast were at once received into alliance. The fleet then proceeded to the Hellespont, to learn, for the first time, that the great bridge of

Xerxes had been destroyed. Leotychides now returned home with the Peloponnesian ships. Xanthippus and his Athenians remained, however, much longer. They captured Sestos and other cities in the Thracian Chersonese, reduced Lemnos and Imbros, and returned to Athens in the spring of B.C. 478, covered with glory.

CHAPTER X.

THE PERIOD OF PAN-HELLENIC UNITY.

(478-461 B.C.)

THE Greeks had brilliantly repelled the Persian invasion. The whole power of the Orient, the fleets and myriads of the Achaemenidae, had proved unable to bring the independent part of the Greek world under Iranian supremacy. The Hellenes had won a good right to look back with pride to Salamis, Plataea, and Mycale. In these battles a crisis in the world's history had been decided. The westward advance of the Iranians had been forever checked. The Greeks now became the dominant race in the world's history, and were to continue such for more than three centuries.

But though the victory was the Greeks', it could not be expected that a treaty of peace would at once regulate the relations between the Achaemenidae and the allied Greeks. On the contrary, war continued for the next thirty years to be the chief element in these relations. And until the march of the Greek hoplites of Clearchus to the plain of Cunaxa with Cyrus, Persian policy toward the Greeks was determined by the remembrance of the experiences of Xerxes. Nor did the Greeks think of letting their arms rest after the battle of Mycale. It was their task now to drive the Persians from the Thracian coast, and if possible to free their kinsmen beyond the Aegean Sea. But first it was necessary to establish themselves again at home, and restore their ruined cities. There was no immediate danger from Persia. Strong Persian garrisons, indeed, still occupied the strongholds from Byzantium to the Strymon. But Alexander I. of Macedon had, after the battle of Plataea, renounced his allegiance to the Persian crown. After Mycale, Xerxes no longer thought of attacking Greece, but only of maintaining his old possessions in Asia and Thrace. He left a part of his troops in Asia Minor, ordered that the capital of southern Phrygia, Celaenae, be made a strong central fortress, and returned himself by way of Babylon to Susa. Under these circumstances the Greeks could breathe freely again.

On the Athenians now devolved the task, above all, of rebuild-

ing their city, on which hung the hopes of all democratic elements in Greece, as well as those of their Ionic kinsmen. In the winter after the battle of Plataea, while the fleet was still lying in the Hellespont, they had already begun to rebuild in accordance with the views of the far-seeing Themistocles. The idea of leaving the ruins of the lower city, and building the capital of Attica anew at the Piraeus, could not be carried out, on account of religious scruples and considerations of public worship. But Athens was to be rebuilt on a scale worthy of the metropolis of a future maritime empire, and large enough to offer refuge to the whole population of Attica in case of another life-and-death struggle. Hence, the new city was to extend far beyond the old one of the sixth century, and the fortification of the port was begun with energy. But the Athenians had to contend with the jealousy of their sister states. Sparta, the leading power in the Greek alliance, seriously proposed that the building of the Athenian walls be suspended. This proposition was based on the insulting ground, that, as in case of a new Persian war central Greece could not be held, the existence of a fortified city in central Greece, which could become a support for the enemy, would be a great disadvantage. The Athenians, not able in their present condition to refuse openly this base demand, resorted to stratagem. Themistocles went as ambassador to Sparta; and while he was waiting for the arrival of his colleagues, Aristides and Abronchus, the whole Athenian population by his advice worked on the walls with great zeal, until they had reached such a height (in the spring of 478) as to be able to withstand an attack. When the news came to the ephors from Aegina of the state of affairs at Athens, Themistocles denied it all with Odyssean readiness, and challenged the Spartans to send reliable messengers to Athens. When the latter arrived at Athens they were, as had been agreed upon, retained as hostages for the safety of the Athenian ambassadors. Themistocles now declared to the Spartan authorities, openly and boldly, that the alliance of the Hellenes rested upon the principle of equal independence of all its members, and that hence the Athenians claimed the right to determine for themselves whether they should have walls or not; and the Spartans accepted the situation.

The Spartans were soon forced to another concession still more painful to them. The result of the great struggle of the year B.C. 479 had vastly increased the political importance of the chief power of the Peloponnese; and the great majority of the Greeks were unwilling, then as later, to recognize the far greater services of the Athenians. The

last crushing blows against the Persians had been struck under the supreme command of Spartan princes, and Plataea was considered a Spartan victory. The political mistakes of the Spartan government, the military errors of their generals, were soon forgotten; the lofty name of Leonidas, the good fortune of Pausanias, the audacity of Leotychides, were remembered to Sparta's political advantage. The memorable scenes of the Graeco-Persian conflicts were covered with monuments of various kinds. The sculptors of Greece created from the proceeds of the Persian booty splendid works of art for the sanctuaries on the Isthmus, at Olympia and Delphi. Dramatic art also drew from the events of these stirring times new impulses and new motives; but in it all Sparta remained for the present the leading power in Greece. Only the Italiotes and the Siceliotes were entirely free from her jurisdiction. The glorious contest waged by the Syracusans and the Agrigentines, entirely from their own resources, against the Carthaginians, had so strengthened and secured the power of the monarchy in Sicily, that it had no need of support from any other Greek power. It was more than fifty years before the western wing of the Greek world was really drawn into the great movements of the mother-country. The Pan-Hellenic sentiment among the tribes between the eastern boundaries of the Asiatic Ionians and the Adriatic Sea was now so strong, that the Hellenes, for almost twenty years, continued politically under the forms of a sort of Pan-Hellenic league, which was, as never before and never afterward, a spontaneous union. At the head of the Greek confederacy could stand at present only Sparta, which had had formal chief command during the war, a position which even the Athenians did not dispute. The Persian storm had too quickly passed over to ruin Attica completely. Still, the Athenians had suffered proportionally more than any other Greek state; and, at any rate, all their energies were too much engrossed in collecting themselves, in developing, and in rebuilding, to allow them to oppose now, in the feeling of full equality, the Spartan supremacy.

The only statesman in Athens who boldly contemplated the future greatness of his city, considered her position as central power of the Ionic and insular Greek world to be the natural result of the Persian wars, and who never hesitated to emphasize the opposition to Sparta, the great Themistocles, was not able to maintain much longer his predominant political influence. It was granted him, however, to lay solidly and securely the foundations of the future power of Athens. Two years after the battle of Plataea the colossal fortifications of

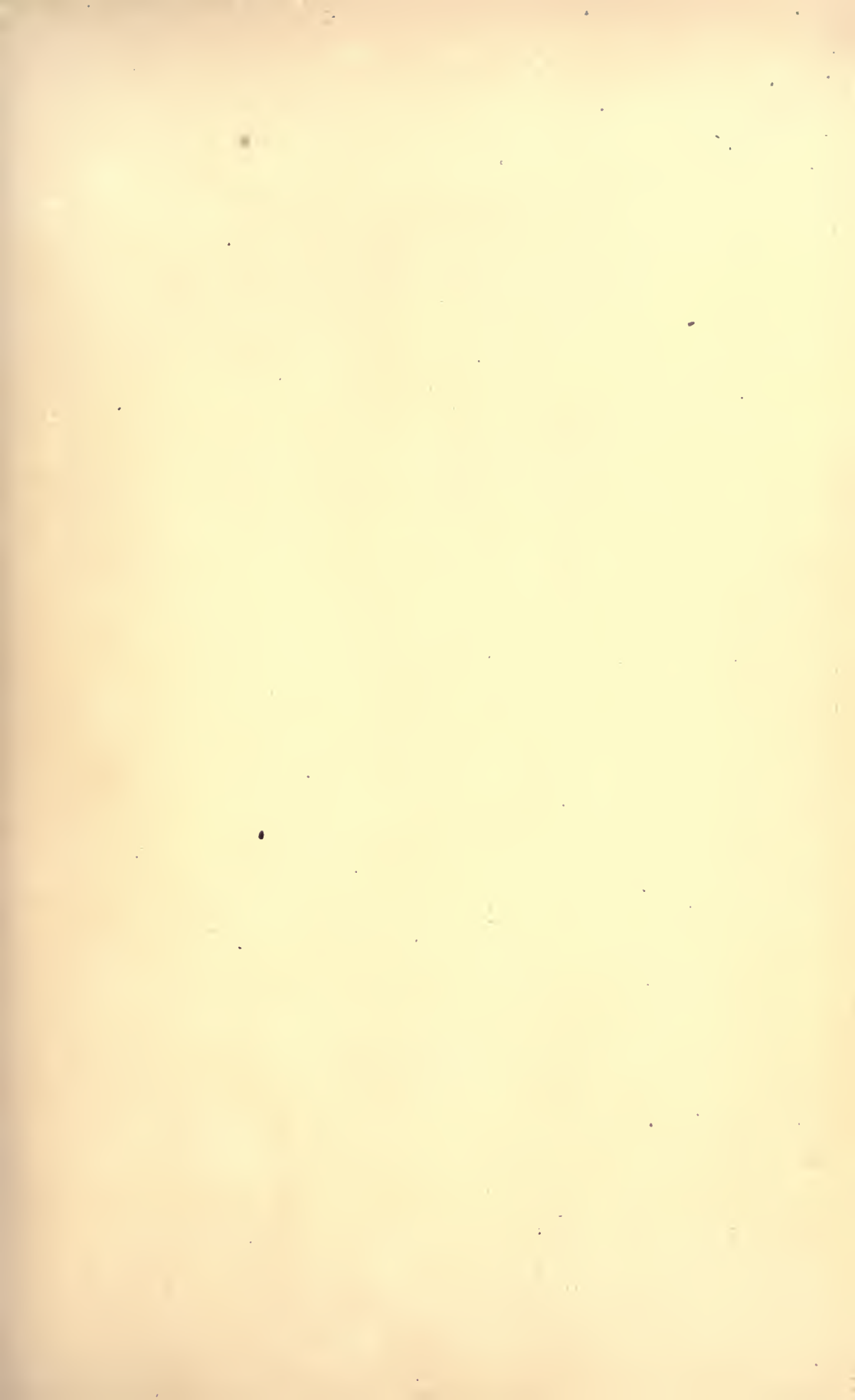



Piraeus at the present time. (From a photograph.)

Athens were completed (477), and then those of the Piraeus (PLATE X.) were begun on a grand scale. An immense wall, faced on the outside with stone, ten to twelve feet in thickness (on the north even thirty-five feet thick), enclosed the whole peninsula for a distance of three leagues, and protected the three harbors, the Athenian war-ships and merchant vessels, wharves, arsenals, as well as the space within



FIG. 134.

which a second Athens was to spring up. It only remained, by building long connecting walls between Athens and the port, to make this position almost impregnable. Besides, Themistocles got the commons to pass a decree adding yearly twenty new ships to the fleet (477 B.C.). But, despite the unquestionable genius and great public services of Themistocles, the Athenians preferred, on the whole, to follow the lead of Aristides, a purer though less brilliant statesman. And the lat-

ter, in these years of development, fortunately supplemented the work of his rival in many respects. By some authorities he is said to have completed the reform of Clisthenes, by carrying through a decree by which the fourth Solonian class received the same political rights as the three upper classes, and therewith eligibility to all offices, even the archonship.

The chief practical result of this step was that now, besides the wealthy land-owners, the possessors of considerable movable property also began to come into the higher offices, while citizens of moderate means were elected in considerable numbers to the Boulé. For financial and military offices, choice was still made by election. Aristides well understood how to reconcile the old ruling elements with the new conditions, and at the same time to satisfy the growing democratic elements. His influence was soon to become still greater.

For the allied Greeks the next task, after they had taken breath, seemed to be to continue the war against Persia, and systematically to cut off the Persian armies and fleets from the way into Greece. Pausanias led, therefore, probably in midsummer, B.C. 478, the allied fleet of 100 ships to sea. The Peloponnesians furnished only twenty ships; the Athenians thirty, under Aristides and Cimon, who made now his first appearance as general; while Samos, Chios, and Lesbos sent the rest. By an audacious but successful attack on Cyprus the Greeks won an important strategical position. Then turning northward they captured, after a long siege (summer, 477), Byzantium, the key of the Black Sea. But now the treacherous bearing of Pausanias prevented for some time the continuance of the war. Pausanias was not strong enough to bear his good fortune, and offended everyone by his arrogance and luxury. He even made an alliance with the Great King, and offered himself as a willing tool for the subjugation of the Hellenes. The Persians gladly agreed to his proposals; and the base intrigue might easily have become dangerous to the future of Greece, had it been possible for Pausanias to restrain for the moment his pride and his tyrannical whims. His brutality and insolence toward the Ionian allies finally caused them to prefer complaints to the Athenian commanders, who seemed from community of race and political ideals their natural champions. Too late the ephors summoned Pausanias home for an investigation. The Ionian squadrons had already renounced his service, and placed themselves under Athenian command. When his successor, Doreis, appeared at Byzantium he was unable to undo the actual transfer of maritime leadership to Athens. This episode (477-476) led to the crisis which decided

the future of Greece until the appearance of Philip of Macedon. The displeasure of the Spartans at the occurrences at Byzantium was at first very great, the more as Themistocles had shortly before defeated the proposition of the Spartans to expel from the Amphictyonic alliance all the states that had not fought against the Persians. For the moment war with Athens seemed inevitable. But soon (475) the view of the senator Hetoemaridas prevailed, that it was better not to engage in expeditions by sea and distant enterprises, in which the ancient discipline and habits of the Spartan soldiers and generals could only suffer detriment. Sparta's true strength was her land army; and the sea might therefore be left to the Athenians. It was not confessed, it is true, that the moral, military, and political education of the Dorian citizens of Laconia, which had proved sufficient in Peloponnesian matters, did not answer the demands of Sparta's Pan-Hellenic position. The theory was now adopted that, though Sparta was by right and agreement the true Pan-Hellenic leading power, it was proper, if the Athenians were willing to shoulder the heavy burden of naval warfare, to allow them, as compensation, the military and political leadership of those maritime and insular states which it was now their duty to protect. The Spartans and the Laconizing elements in Greece could therefore consider the new hegemony of the Athenians over the Ionian communities as delegated, as it were, by the chief power. So Sparta quietly allowed Athens to organize the Confederacy of Delos, which was considered as a kind of narrower alliance, like the Peloponnesian, within the Pan-Hellenic league. The Athenians now devoted themselves with ardor to the practical organization of the abundant resources at the disposal of themselves and their maritime allies, which now included almost all the islands from Euboea to Samos. Aristides was appointed to arrange the new confederacy, which should combine outward stability and military efficiency, as well as the necessary influence of the leading power, Athens, with the equality and freedom and independence of its individual members. In this sense the assembly of the allies unanimously adopted the federal constitution, according to which Athens, as leading power, was to represent the foreign interests of the alliance, diplomatic and military. With the internal relations of the separate members, neither the alliance nor the leading state could interfere; each being free and independent in matters of constitution, government, legislation, and administration of justice. The central point of the confederation was the island of Delos, sacred from of old to the Ionian race. Here the federal assembly met, in which all states, large and small, had an

equal vote. This assembly decided matters of war, finance, and other federal interests, and settled disputes between members of the alliance. The contingents of war-ships and men required for the maintenance of a strong and efficient fleet, and the yearly contributions of money to be made by the separate states toward the establishment of a war-fund and of a fixed budget, were exactly defined. Aristides drew up the constitution. His proposals were recognized as just and proper, and accepted without delay. The amount of the yearly federal tax fixed by him was probably about 100 talents. This federal treasure was also deposited at Delos, and managed by a new commission, the Hellenotamiae. But although the confederation rested on the principle of universal equality, it was an important fact that Athens, the strongest power in the alliance, appointed the Hellenotamiae, managed the finances, collected the yearly taxes, and furnished not only the strongest contingents, but also the commanders of the army and navy. Gradually but inevitably relations sprang up which caused the Athenian Hegemony to develop into a decided supremacy, that transformed the Confederacy of Delos into the Athenian Empire.

In Athens itself the influence of Themistocles was perhaps not so much obscured by the new brilliant creation of Aristides as by the victories won from this time by Cimon at the head of the Attic-Ionian fleet. The abundant strength and restless activity of young and growing Athens were most impressively displayed from B.C. 476 on. The fleet of the Delian Confederation, under the lead of Attic strategy, was unceasingly in motion. A great part of the Athenian citizens were continually with the fleet, where they became thoroughly acquainted with maritime life, and acquired that mastery in all naval exercises and tactics which gave them for two generations an undisputed superiority over all other maritime peoples of the eastern Mediterranean. The Athenians were wont to re-elect a tried general year by year, who thus acquired great moral superiority over his nine colleagues, and was to the allies the personal representation of the Attic government. The successful leader, who during the whole time until the break with Sparta filled the Aegean Sea with the glory of his name, was Cimon, son of the victor of Marathon and the Thracian princess Hegesipyle, born between 507 and 504 B.C. The young friend of the elderly Aristides, he was, with his conspicuous strategical talent, his pleasant manner toward the allies, his chivalrous conduct, his affability and sociability, in a high degree the favorite of the Ionians, as of his own sailors and soldiers. He now proceeded to clear the northern coast of the Aegean

of Persian garrisons, meeting with no serious resistance except at Eion on the Strymon, which fell after a long and heroic defence, and from the treacherous Pausanias, who had without great trouble escaped any severe punishment at Sparta, and in the year 476 had gone of his own accord to Byzantium, established himself there independently, entered into close relations with Artabazus, who now resided at Dascylium, and was using his own, as well as the Persian, resources to prevent the growth of the Delian alliance.

As the belief in the indispensability of Themistocles vanished before Cimon's successes, the hate with which Sparta now pursued him became dangerous. Themistocles had strongly desired that the Athenians should take advantage of the difficulties in which the Spartans had lately become involved. A campaign against the Thessalian Aleuadae (476-475) had, after some successes, ended unfavorably, through the corruption, it was said, of Leotychides, who was banished in consequence. But far more apprehension was felt in Sparta at the growing insubordination of the Arcadians, especially of the Mantineans and the Tegeates, the democratic tendencies of the Eleans, and the continual hostility of the Argives. It was believed that Themistocles desired to promote friendly relations between the Athenians and these opponents of Sparta in order to acquire for Athens the supremacy in Greece. Such plans were, however, far from the minds of most of the Athenians, who were sufficiently occupied with restoring their prosperity, with the new development of their trade, and with the Persian quarrel. Under these circumstances Cimon, who was favored by Sparta, became more and more popular. He knew how to maintain the dignity of Athens, but wished at the same time to preserve the connection and good understanding with Sparta. Themistocles's influence sank to such a degree that Aeschylus, in his great poetical monument of the life and death struggle, the tragedy of the "Persians," brought out in 472 B.C., even in the description of the battle of Salamis, puts him into the background in a manner as unjust as it was conspicuous. The full explanation for these things is not known; but at any rate he was ostracized in 470, and retired to Argos, never to return.

Cimon was now the leading statesman in Athens, and for some time without a rival; for the more democratic elements, which were hostile to Sparta, were as yet without leaders. Besides, Cimon was very popular with the people. Rather a general than a statesman, highly esteemed by the soldiers and sailors as a successful leader, beloved by the citizens, especially the poorer classes, for his honest,

approachable manner, and his magnificent generosity and hospitality, he was the last great aristocrat of the old school. He continued for several years to wage successfully the naval war against Persia, in order to extend the Delian Confederacy, develop the maritime power of Athens, and at the same time direct her energy away from Sparta. Among his achievements during this period may be mentioned the expulsion of Pausanias from Byzantium (470), the stoutly resisted reoccupation of Eïon (469), which had been seized by Thracian marauders, the conquest of Seyros, the island of the Dolopian pirates (468), the complete expulsion of the Persians from the Chersonese (467), and, indeed, the extension of the Delian alliance to the northern outlet of the Bosphorus. It was probably in consequence of the intrigues of Pausanias that the Persian court, in 466, resumed the offensive. In the Phoenician, Cilician, and Pamphylian harbors active preparations were going on; the island of Cyprus was lost again by the Greeks, and in Cilicia a strong army assembled under Pharandates. Cimon, however (probably in the summer of 465), effectually checked the advance of the Persians. He sailed with 300 ships to the Pamphylian waters. The Persian fleet, 350 ships, under Tithraustes, hastily withdrew into the mouth of the Pamphylian river Eurymedon; but Cimon followed, forced them to fight, and beat them completely. When the fleeing crews united with the Persian land troops on the shore, he renewed the battle, routed the Asiatics, and captured their camp. Re-embarking forthwith, he defeated a reserve fleet of 80 ships at Idyrus, about 55 miles east of the Eurymedon. Thus was won for the Delian Confederacy complete maritime supremacy in the eastern Mediterranean. The whole west coast of Asia Minor now fell away from the Persians, as well as their last European possession, Doriscus in Thrace.

In the meantime the traitor Pausanias had met his fate. After his expulsion from Byzantium, he maintained himself for some time as prince, under the supremacy of the Great King, at Colonae, until at last the ephors, out of regard for Athens, were induced, at the beginning of the year 466, to summon him with severe threats to Sparta. Here he continued his intrigues in the Persian interest, and plotted finally to win the Helots for his plans. The ephors let him carry on his underground work in this way until he had so strongly compromised himself that no political considerations could save him. When Pausanias was about to be arrested, he fled to the temple of Athena Chalcioecus. Since the right of asylum of the sanctuary protected him here, the ephors had the doors of the chamber walled up; and he died miserably from hunger (toward autumn, B.C. 466).

The affairs of Peloponnesus were going ill for Sparta. Elis had become a complete democracy; the Arcadians were restless; Argos was showing a renewed aggressive spirit, which resulted in the capture and overthrow of the ancient and autonomous cities of Tiryns and (B.C. 468) Mycenae. Nevertheless, Sparta pursued stubbornly her purpose of revenge on Themistocles, whom, even in exile, she still hated and feared. It was charged that Pausanias had attempted to win over the great Athenian to his shameful plans. The Spartan government accused Themistocles at Athens of high treason, and proposed that the exile be condemned to death, and that Argos be required to give him up. The political and personal enemies of Themistocles in Athens, including Cimon, secured the hearing of the complaint and the sentence of death, though it was judicially and politically unwarrantable. The hero of Salamis had to flee like a hunted wild beast, going from Argos by way of Coreyra to the court of the Molossian prince Admetus; thence to Pydna in Macedon. From here he went by sea, narrowly escaping an Attic blockading-fleet at Naxos, to Ephesus. Here he determined to throw himself upon the generosity of the Persian sovereign, Artaxerxes I. At the Persian court he soon secured great influence, which he maintained until his death by amusing Artaxerxes with impossible but dazzling schemes of Western conquest.

Meanwhile conditions had developed within the Confederacy of Delos which presaged evil for the future. With a part of the Ionian allies a desire to take their ease prevailed; and, feeling now secure from Persian attacks, they began to wish relief from their burdensome military duties. As one community after another became dissatisfied with the head of the alliance, the sectional feelings of the Greeks awoke with new strength, and they began to wish to desert the confederation. These evil tendencies gradually made a great change in the relation of the Athenians and their allies. There was a limit to the indulgence even of men like Aristides and Cimon. Athens could not permit individual communities to withhold the performance of their federal duties, nor could she allow this state or that to withdraw from the alliance, on whose existence depended, not only her own power, but the security of all from new Persian attacks. In consequence of this flagging zeal on the part of many of the allies, Cimon had introduced the system by which these were allowed to substitute the payment of money or the furnishing of empty ships for personal service. With this money Cimon was able to substitute Athenian recruits for any allies that might drop out, and kept increasing the Attic navy. Thus the allied fleet became more and

more decidedly Athenian. But open desertion from the alliance even Cimon forcibly opposed. The first great defection was that of the large island of Naxos, early in B.C. 460. After a long siege, it was subdued in the summer of that year, disarmed, stricken from the number of independent members of the alliance, and made a tribute-paying subject-ally of Athens. But in spite of this, the island of Thasos soon after defied the Athenians. The Thasians were discontented because they observed that the Athenians were trying to win territory on the Thracian coast, and reap the profit of the rich gold mines of Mount Pangaeum, where the Thasians had long possessed an extensive mining district. The Athenians sent in the spring of 459 B.C. ten thousand Greek settlers to Eion, who won the important position of Enneahodi (afterwards Amphipolis). But advancing northeastwards into the interior, in order to settle in the immediate neighborhood of Pangaeum, they suffered at Drabescus a crushing defeat at the hands of the enraged Thracian aborigines. The Thasians now made an alliance with Alexander of Macedon, who saw with displeasure the Athenians settling on the southeastern border of his country, and renounced their connection with the Delian alliance (probably midsummer, 459). Cimon was able to conquer them only after a long and hard conflict; and then they, too, were disarmed, robbed of their fleet, and forced to give up their Thracian possessions.

When Cimon returned to Athens, Aristides having died, he found the situation considerably changed. A new generation was coming on, whose leaders were determined more and more to exclude the aristocratic elements from public affairs, and, remembering Themistocles, to secure at last to Athens the place that was due her, without further regard for the jealousy of Sparta and her allies. The real leader of this young democratic school was Ephialtes, an able legal counsellor, a forcible speaker, personally esteemed as an honest, conscientious, incorruptible, and unselfish man, of great determination and firmness, but also feared by many powerful men on account of the severity with which he persecuted retiring magistrates for perversion of official power to the detriment of the common man. To his support had come the ablest man of the younger generation, Pericles (born 493), son of Xanthippus, the victor of Mycale, and of Agariste, niece of the reformer Clisthenes. The gifted son of a wealthy house, Pericles had an excellent education; and in intercourse with such teachers as the philosopher Anaxagoras of Clazomenae, — only six years his senior, and afterwards his lifelong friend, — he had acquired a liberality of

mind rare among his contemporaries. Always strict and temperate in his habits, a man of tireless energy and of the most enlarged views, endowed with oratorical talents, whose majesty and grace afterwards enchanted the Athenians, rich in creative power, he did not enter public life until about the time of Aristides's death. It was, however, by no means easy for Ephialtes and Pericles to rise in the face of Cimon's great and well-deserved popularity. They first sought to offset the effect of his extraordinary generosity to the masses by the introduction of public charities to the poor, especially that of the 'theoricon,' or money for admission to the theatre. From the surplus of the public money the price of admission to the theatre (two obols, or about seven cents) was paid to the poorer citizens. (This money, it should be observed, went to the superintendent of the theatre, and returned indirectly into the public treasury.) This party made also a strong attack upon Cimon personally. His fall seemed to them absolutely necessary, in order that the whole policy of Athens might be directed into other and more democratic courses. But for the present Ephialtes had miscalculated. The charge made after Cimon's return from Thasos, that "bribed by Macedonian gold he had, after the fall of Thasos, failed to punish King Alexander for his intrigues against Athens," was unsuccessful; and Cimon's power seemed to be more firmly established than before. Just then the folly of the Spartans caused a sudden and complete change in the situation at Athens.

The Thasians had secretly sought help against Athens; and Sparta had, in her jealousy of the prosperity of her sister state, really determined on an attack upon Attica. She was making preparations when a higher power intervened. In the autumn of 459 Laconia was visited by a terrible earthquake. Sparta was practically destroyed; more than 20,000 men perished; and the Helots, who were deeply embittered by the bloody persecution that had followed the discovery of the conspiracy of Pausanias, now rose in insurrection. Only the prudence and energy of the young king, Archidamus II. (since 468), grandson of Leotychides, saved the city. The Helots rose, and threw themselves into Messenia, whose enslaved people also took arms. A new war, known to history as the Third Messenian War, broke out; and the Spartans had the greatest trouble in subduing their opponents, even in the open field. The stronghold of the insurgents was again, as three hundred years before, the fortress Ithome. After all the attempts of the Spartans and their allies to take it had failed, Sparta demanded, on the basis of the federal alliance, help from the Athe-

nians (early in B.C. 457). The parties at Athens came into sharp collision in the debate on the question of granting or refusing the request. But Cimon once more threw his whole influence into the scale, gave full emphasis to the Pan-Hellenic idea, effectively revived the recollections of common service in arms with Sparta during the great national war, and finally received orders to lead 4000 hoplites to Messenia. But the folly of the Spartans themselves irretrievably ruined Cimon's influence in Athens. The insurgents had, with Attic help, been shut up on the top of Ithome; but the siege lagged. The Spartans became suspicious, and finally, while retaining the other allies, sent the Attic contingent home (about autumn, 457), on the pretext that their help was no longer needed. The effect on the minds of the Athenians was fateful for the future of Greece. The Spartans had with one blow destroyed the Pan-Hellenic policy of Cimon. The party favorable to them at Athens vanished, except for some fanatical oligarchic coteries. Immediately after the return of the army from the Peloponnese the leaders of the democracy succeeded in breaking off the alliance with Sparta. Then the Athenians hastened (winter of 457-56) to make an alliance with several states of the mainland, that were opposed to Sparta; first with Argos, then with Thessaly. The hostility of the Megarians to Corinth finally led these also to join the new Athenian alliance. Thus scarcely twenty years after the victory of Plataea the slight frame of national unity was broken forever, and Greek dualism took its place.

CHAPTER XI.

THE AGE OF PERICLES.

(B.C. 460-430.)

BY this defeat of Cimon's foreign policy, the strength of his party at home was greatly weakened. To the democracy the proper moment seemed to have come for an attack upon the strongest bulwark of the aristocratic and conservative elements; namely, the Areopagus.¹ With its power to veto at discretion all acts of the Boulé and the Ecclesia that to it seemed hazardous, it was an obstacle to all attempts to make Athens more thoroughly democratic. Ephialtes and Pericles [Themistocles] proposed to deprive it of its political and censorial power, and to limit it to its functions as highest tribunal in cases of homicide. After a hard struggle with the adherents of the old constitution, the 'aristocrats,' the measure was adopted in the Boulé and in the Ecclesia. The democratic leaders were now able to introduce the regulations within which the people moved until the close of the Peloponnesian war. The censorial power, hitherto exercised by the Areopagus, was made democratic. The right of oversight over the youth was transferred to a new annual commission of ten *sophronistae*, and well-devised precautions were adopted by which the intelligent democracy of this time thought to meet the danger of thoughtless, over-hasty, frivolous changes of the laws and of the constitution. This object was accomplished by the right of every citizen to bring complaint before the Heliaea of the illegality (in form, content, or spirit) of any new measure, either before or after its adoption, as well as to bring within a year after the adoption of such measure personal complaint against the author. If the jury decided in favor of the complainant,

¹ Aristotle's recently discovered work on the Athenian Constitution requires us to view these events in a different relation. The prime movers in the assault upon the Areopagus were Themistocles and Ephialtes, not Pericles and Ephialtes. Cimon's foreign operations followed this affair. The prominence of Pericles in public life began about 455, and not as early as 460 B.C. It is not impossible, however, that Pericles played a subordinate part in the reduction of the power of the Areopagus. The dates of most of the occurrences between 462 and 450 have been hitherto placed about three years too early. They have been silently corrected by the translator.—ED.

the obnoxious measure was liable to fall through; but if the complainant was defeated, he was fined. The separation of the department of justice from that of administration was made wider in every respect. From all magistrates, especially the archons and members of the Boulé, all judicial powers were withdrawn, except that the individual archons and the Boulé retained jurisdiction in petty causes, for which fines up to fifty drachmae could be imposed. It continued to be the duty of the archons to conduct the preliminary examinations and preside in the courts; to direct the proceedings and execute the sentences. The tribunals, except the Areopagus, were now great jury-courts, in which a large part of the Attic citizens were occupied all the year with the administration of justice. From year to year, it seems, 6000 jurymen were selected by lot, 500 for each dicastery, and 1000 substitutes. In criminal cases the jury consisted of 1000 or 1500. The great abundance of judicial business made it impossible to get without compensation the requisite number of jurymen of the middle and lower classes. Hence Pericles — a few years later (between 451 and 447) — found it necessary to have the jurymen paid an obol (about three cents) or at most two obols, daily, just enough to buy bread for the day.

Almost simultaneously with the break with Sparta came the moment when the commons became sovereign at Athens. But the fact must not be overlooked, that, as we have before remarked (p. 138), the so-called working-class did not count in the politics of the Greeks (nor did it later in Rome). The ancient governments were slave-states, becoming, indeed, more and more so as they grew in importance, so that in political movements only the patricians, burghers, and free peasants came under consideration.

But the democracy was not to enjoy its victory in quiet. Only a part of the aristocratic or conservative party had accommodated itself to the innovations. Many were irreconcilable, especially as the courts were very strict in holding the magistrates to account for the administration of their offices. The irreconcilable elements now directed their sympathy and hopes to Sparta. The new leaders expected, of course, that sooner or later a conflict would arise with Sparta and her allies, and they delayed not to make preparation in two directions. On the one hand it was proposed to transfer the federal treasure from Delos to the Acropolis (Fig. 135; PLATES XI., XII.) for security in case of war. The Samians proposed therefore, in the federal assembly, the adoption of this measure, which a few years later was carried out (B.C. 455-454). Pericles next executed his plan of connecting Athens with the harbors

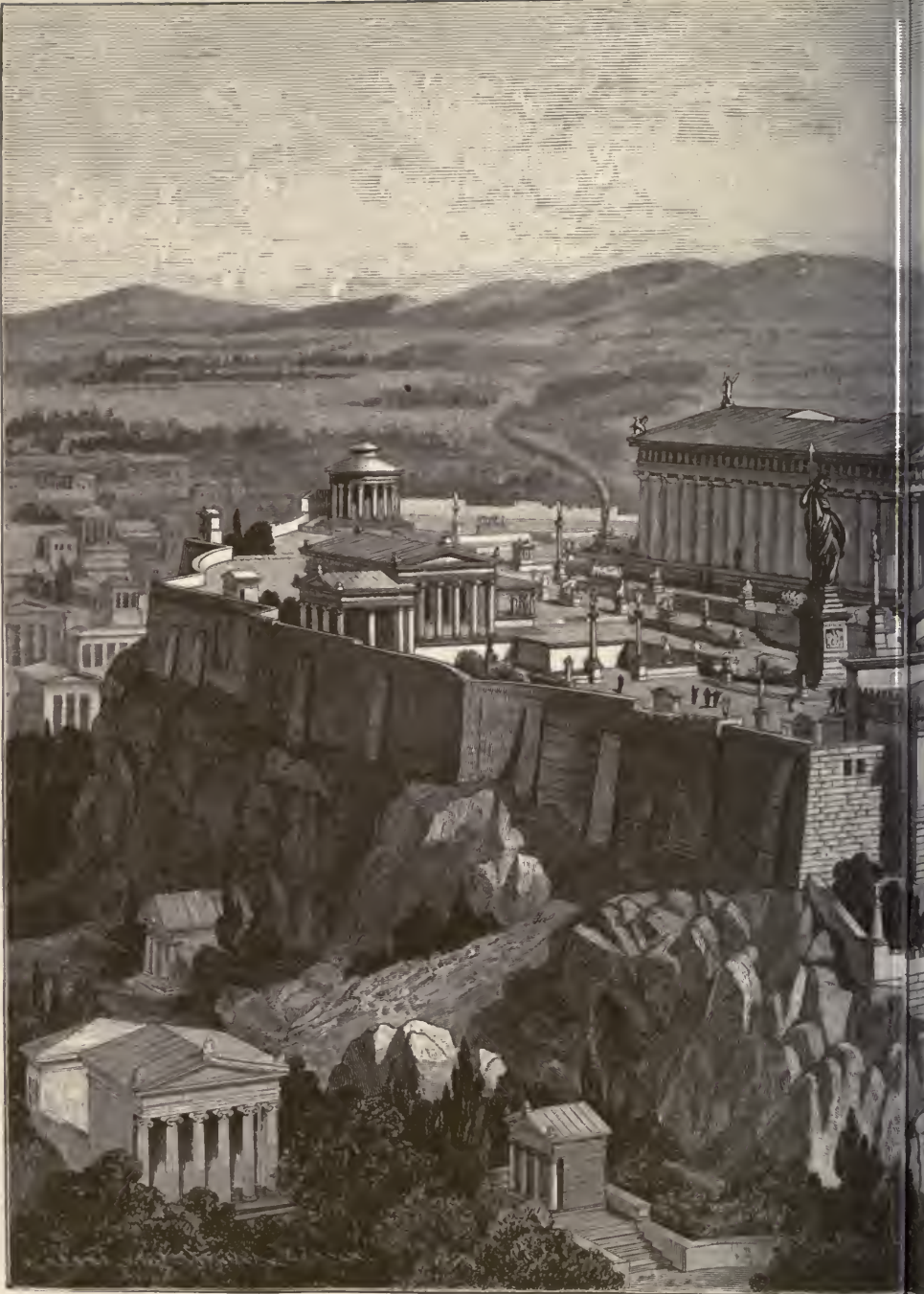

History of All Nations, Vol. III., page 218.

The Acropolis
Restoration drawn by



G. Rehlender sc.

Acropolis of Athens.
Engraved by G. Rehlender.

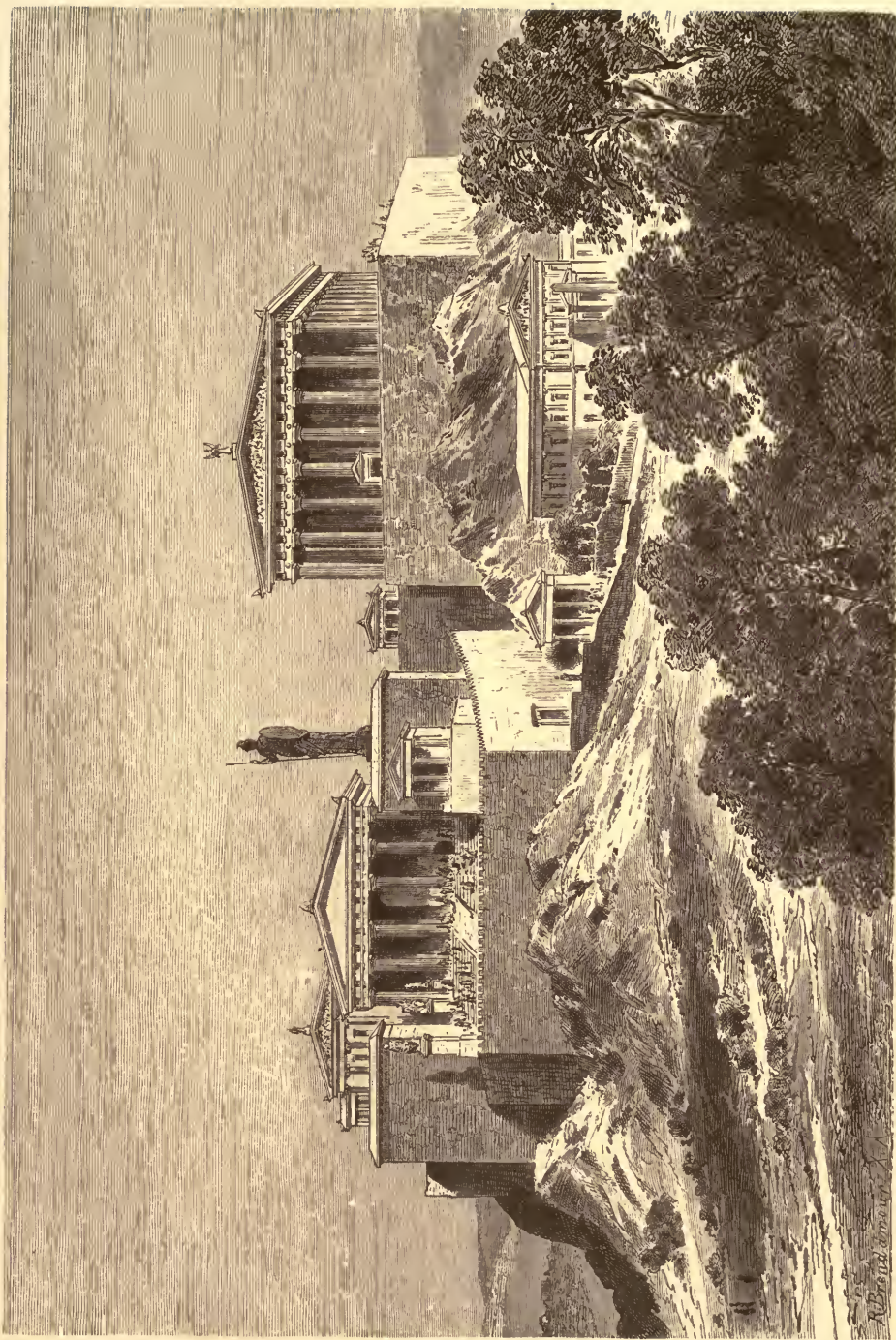

The Acropolis at Athens; restoration by G. Theuerkauf.

Erechtheum.

Propylaea.

Athene Promachos.

Parthenon.

Temple of Nike Apteros.

History of All Nations, Vol. III., page 218.



by long walls. Cimon had already had the foundations laid, and the work was now pushed with energy. While this gigantic work was in course of erection the Athenians built in Megaris similar walls on a smaller scale. In order the better to secure the Megarians against Corinth, and to strengthen their own position in this important district, by which they controlled all the ways from the Isthmus to Central Greece, as well as the western harbors of Pegae and Aegosthenae, they united the city of Megara with its harbor, Nisaea (a mile distant), by two strong walls. This military occupation by the Athenians of a position before the very frontiers of Corinth, led to the outbreak of the first Peloponnesian war. The Spartans, still occupied at Ithome, were not in condition to take the field openly against Athens; but they rejoiced



FIG. 135.—The Acropolis of Athens. Photograph.

to see Corinth, in league with Epidaurus and Aegina, seize the moment when a large part of the Attic forces were occupied on the Nile to strike a blow at her. Egypt had revolted from Persia during the time of confusion that followed Xerxes's death; and the leader of the revolt, the Pharaoh Inarus, had received, in answer to his appeal to Greece for help, 200 Attic triremes. The Athenians and Egyptians won early in the year 457 a brilliant victory over the Persians at Papremis, on one of the arms of the Nile, and then, after occupying Memphis, laid siege to its citadel, the "White Castle." But the situation of Athens was critical when the Peloponnesian naval powers opened their attacks. The first conflict was unfavorable to the Athenians. The veteran Myronides was defeated at Halieis in Argolis by the Corinthian and Epi-

daurian forces. But not long afterwards (autumn, 456) an Athenian fleet won a brilliant victory at the island Ceeryphalia (between Aegina and Methana) over the Peloponnesian fleet. A great naval victory over Aegina, not long afterwards, enabled the Athenians to attack the island itself. They proposed now to destroy the political independence of their oligarchical and irreconcilably hostile neighbor. Leocrates besieged Aegina by land and sea in June of 456. The Peloponnesians directed all their efforts to its relief, but they failed for the most part. When, in the early summer of 456, Corinth and Epidaurus sent a strong force against Megaris, Myronides summoned the last resources of Athens — the youths not yet liable to service in the field, and the veterans among the citizens; and first discomfited, then, in a second battle, completely defeated, the enemy. Nevertheless, the position of Athens, occupied as she was in Egypt, Aegina, and Megaris, gradually became very difficult, especially as the embittered oligarchic elements in the city saw with displeasure the rapid progress of the Long Walls, which, once finished, would make Athens almost invincible against Sparta. This party did indeed show its hand when the Spartans, in 455, took part in the war. An invasion by the Phocians of the little mountain district of Doris gave the Spartans a pretext for appearing with a strong force on the scene of action in Central Greece, and here to put into operation plans against the Athenians which had certainly been well weighed before the troops left Sparta. At mid-summer, 455, an army of 1500 hoplites from Laconia and 10,000 allies sailed from Sicyon for Central Greece under Nicomedes, son of Cleombrotus, and guardian of his nephew, the young King Plistoanax (son of Pausanias), who had succeeded to the throne on the death of Plistarchus. The Phocians were forced to restore the conquered territory to the Dorians. Meanwhile this expedition had excited the suspicion of the Athenians. They hastened to occupy the passes in Megaris leading to the Isthmus, and at the same time sent a fleet to exclude the Peloponnesians from the Crisaeon gulf. It now appeared that the opposition between Athens and Sparta had already assumed the character of a political propaganda. The Spartans sought to win over and strengthen in all possible places the aristocratic or oligarchic parties, and to incite these, in their interest, to restrain the Athenian or democratic influence. Athens, on the other hand, sought to spread her principles everywhere, to animate and aid the democratic elements in the rest of the Greek states, and in this way to strengthen and extend her own power. Thus was inaugurated that historic development, in consequence of which the Hellenes gradually grouped them-

selves more and more exclusively about Athens, or about Sparta, and ruinous dissension was introduced into nearly every Greek community. The Peloponnesians began by erecting in Boeotia (455), where the patricians were still all-powerful, a bulwark against Athenian expansion. The Boeotian alliance had collapsed after the battle of Plataea and the humiliation of Thebes. The army of Nicomedes now established itself in the Copais valley, in order to restore the power of the Thebans over the Boeotian cities, and to secure the supremacy of the aristocracy. Some of the leaders of the fanatical oligarchy in Athens now invited Nicomedes, it is said, to advance against Attica. He was to support here an insurrection by which the oligarchy hoped to prevent the completion of the Long Walls, and to overthrow the democracy. When, then, Nicomedes led his army to Tanagra on the Attic frontier, the Athenian demos was in great anxiety.¹ Even Cimon's friends were strongly suspected. At such a crisis Pericles summoned the last resources of the Attic people, and called on the new allies for help. When a thousand warriors from Argos, some other allies, and a Thessalian cavalry corps had assembled in Attica, the army, numbering 14,000 infantry, took the field. In the valley of the Asopus, below Tanagra, the best troops of Greece were—in sad contrast to the battle of Plataea—to measure strength with one another. When the battle was about to begin, Cimon begged to be allowed the favor of fighting as a hoplite in the ranks of his phyle, Oeneis. When his enemies refused this, nothing remained but to urge his friends to silence by their deeds all doubts of his loyalty. But all the devotion of these men, all the bravery of Pericles at the head of the phyle of Acamantis, could not attract victory to the Athenian standards. After a hard battle the Athenians were defeated, mainly because the Thessalian cavalry deserted to the enemy during the second day of the fight.

Nevertheless, the defeat at Tanagra (probably late in August, 455) had not for Athens the evil results that were feared. The victory of the Spartans was not so decisive as to encourage them to invade Attica, where the insurrection had not come to an outbreak. Nicomedes returned without opposition through the passes of Megaris to the Peloponnese. Athens aroused herself anew. Quite in contrast with the slow ways of the Spartans, who did not know how to improve their

¹ Aristotle, in his *Constitution of Athens*, requires us to suppose that Cimon had been ostracized a few months before the battle of Tanagra, when the operations of the Spartans in Central Greece had strengthened the anti-Spartan element in the Athenian state. — ED.

advantages, the Athenians fell, a few weeks after the battle of Tanagra, upon the resuscitated power of the Thebans. Myronides invaded Boeotia, routed at Oenophyta, sixty-two days after the battle at Tanagra (end of October, 455), a superior force of the Thebans and their allies, and improved his victory to the utmost. Thebes alone was able to withstand the Athenians. But all the new creations of the Spartans in central Greece were overthrown, the Boeotian alliance broken up, the chiefs of the Boeotian patricians friendly to Thebes expelled, and democratic governments established in all the Boeotian cities. In this way the Athenians bound Boeotia to their alliance. The Phocians, too, readily obeyed their summons. Eastern Locris, by whose acquisition Athens extended her power to Thermopylae, was held fast by requiring a hundred prominent men to be sent as hostages to Attica. Meanwhile, the energetic citizens at home finished the Long Walls; and the perseverance of the blockading squadrons prevailed over the endurance of the oligarchs of Aegina (winter, 455-454 B.C.), who now had to level their walls, surrender their war-ships, and become tributary subjects of Athens. The bold Tolmides sailed, a year later, with a strong fleet, around the Peloponnese, destroyed the Laconian dock-yards at Gytheum, won the islands Zacynthus and Cephallenia for the Athenian alliance, and captured Naupactus, whose strategical position at the mouth of the Corinthian Gulf made it very important. But an expedition of Myronides for the purpose of taking revenge on the faithless Thessalians, whose defection had lost the battle of Tanagra, was unsuccessful.

In the year B.C. 452, in which Pericles won Achaia for Athens, the fortune of the Athenians had reached its culmination. After this affairs took an unfavorable turn. The Messenians on Ithome surrendered in the spring of 451, on condition of being permitted to leave the Peloponnese. Thus the Spartans recovered freedom of action in Greece just when a great catastrophe befell the Athenians in Egypt. Artaxerxes I. had done everything to recover Egypt. Themistocles indeed, to whom he had given a principality on the Maeander, had been unable or unwilling to serve the king against Athens. (He appears to have died in 448.) What influence, then, the negotiations of Megabazus with Sparta, early in 455, may have had on the events of that year may be passed over. At any rate, the Great King made great preparations by land and sea; and Megabazus at the beginning of 453 departed from Syria for the Delta with 300,000 men. A defeat forced the Egyptians and Athenians to leave Memphis, and withdraw early in 453 to the district of Prosopitis (between the Canopic and Sebennyitic arms of the

Nile), where they were blockaded for eighteen months. At last Megabazus succeeded in draining a canal which connected the arms of the Nile, thereby rendering the Attic fleet useless, and in July, 451, took the island by storm. Of the conquered Greeks, only a few escaped; more than 30,000 were slain, 6000 were captured, and 50 freshly arrived Attic ships were lost in the Mendesian arm of the Nile. This terrible blow was severely felt in Athens; and though the energy and shrewdness of the Athenians did not abate, as shown by their settling the Messenians from Ithome straightway at Naupactus, yet they were after this less enterprising. Pericles himself desired peace; Athens needed rest. If another conflict was to come, it was important to check the arrogance of the Persians, which had revived since the battle at Prosopitis. Dangers of this sort, as well as other considerations, had already led to the transfer of the federal treasure from Delos to Athens. To reconcile internal factions, Pericles determined to come to an adjustment with Cimon. On his motion (probably late in the year 452) Cimon was recalled. The latter then concluded, in the autumn of 449, an armistice with Sparta for five years. Sparta seems to have declined to make a definite peace, in order to avoid acknowledging the political destruction of Aegina, but was shrewd enough to render Argos harmless by concluding a thirty years' peace.

Nothing now hindered the Athenians from striking one more blow at the Persians, again lending a hand to the Egyptians, and winning back their lost position on Cyprus. In the spring of 448 Cimon sailed with an allied fleet of 200 vessels for the eastern Mediterranean, sent sixty ships to the Delta, steered with the main force for Cyprus, took a number of cities, and commenced the siege of Citium. Here a wound, followed by a severe illness, put a premature end to the life of the brave general in the spring of 447. But the terror of his name still helped his troops to win glorious victories. The Athenian staff concealed his death for the present, and for thirty days orders were given in his name. His lieutenant, Anaxicrates, sought the fleet which Artabazus, then satrap of Cilicia, had led to the Cyprian Salamis. The Athenians with their old vigor crushed the far greater fleet of the Phoenicians and Cilicians, and won soon afterwards on the coast a victory over the Persian land troops, who had crossed over to Cyprus. Then the ships were recalled from the Delta, and the victorious fleet returned to the Piræus. Herewith ceased for a period of thirty-seven years the conflicts between the Athenians and the Persians. But that a treaty was struck between these two powers, — a treaty that figures largely in the ora-

tors — seems to be a fiction of a later time. According to this treaty, the autonomy of the Greek states on the west coast of Asia Minor was acknowledged. The Persians, on their part, pledged to keep their troops at a distance of three marches from the coast, and not to allow their war-ships to pass the heights of Phaselis in the south, or the Cyanean islands at the mouth of the Bosphorus in the north, while the Athenians gave up Cyprus and their connection with Egypt. The Athenians seem to have made proposals to this effect a short time before, at Susa; but they were rejected, although the discouragement of the Persians allowed this state of affairs actually to exist.

At any rate, the foreign policy of Athens was now dominated by Pericles, who sought above all to cultivate peace, to increase the trade of Athens, to hold together the resources of the city for the maintenance of her position in Greece, but to avoid everywhere far-reaching undertakings which did not promise sure and solid results.

Perhaps at this time,—the exact date is uncertain,—acting in a spirit of broad and far-seeing statesmanship, he induced the Athenian assembly to send twenty ambassadors to invite all the Greek states to a Pan-Hellenic congress at Athens, where they were to take counsel concerning the restoration of the Greek temples destroyed by the Persians, about the performance of unfulfilled vows made for Hellas at the time of the national war, about the security of the sea, universal commerce, and peace in general. But the jealousy of the Spartans, Peloponnesians, and Thebans made the execution of this plan impossible, and immediately afterwards other tasks required attention.

The quarrel between Athens and Sparta was rekindled as early as 448, by the attempt of the Phocians to supplant the Delphians in the management of the Temple of Apollo. The Spartans sent an expedition to Parnassus, by which the temple was restored to their Delphic friends. But scarcely had they marched away when the Athenians re-established the authority of the Phocians in Delphi. Before Sparta could make her counter-move the whole Athenian continental alliance began unexpectedly to totter. The new democratic government which had succeeded to the authority of the old patrician rule in Boeotia, after the battle of Oenophyta, was notoriously bad and insufficient, and oppressive toward the old masters of the land. Except in Plataea, Thespieae, and Phocis, this new order of things was largely regarded as a despicable foreign rule. Incited probably by Sparta, the expelled Boeotian patricians, many Locrians and Aeginetans, some Phocians and other enemies of Athens, finally collected a strong force, invaded Boeo-

tia, and surprised the cities of Orchomenus and Chaeronea (447 B.C.). The Athenians underestimated the danger; and, in spite of the warnings of Pericles, Tolmides, with only a thousand hoplites, mostly young volunteers from good families, and a few allies, hastened to the scene of action. He was surprised near Coronea by a superior force of the enemy. His army was defeated with great loss; he himself was slain; many were captured. In order to recover the prisoners, the Athenians had to agree to give up all Boeotia except Plataea, and to permit the old aristocracy to return to power. The defection of Boeotia drew after it that of Phocis and Locris; central Greece was lost to Athens, and in 446 the revolt extended to Euboea. When Pericles hastened thither with a strong force, Megara also rose in revolt behind him. And now the five years' truce arranged by Cimon having come to end, the young Spartan King Plistoanax and his adviser Cleandridas led a strong army of Lacedaemonians and Peloponnesian allies to Attica.

It looked now as if the whole proud structure of the Athenian power had been levelled at a single stroke. But the prudence of Pericles, and perhaps the judicious use of bribes with the Spartan commanders, averted for a moment the most pressing danger. The Peloponnesians withdrew from Attic territory without a battle. Pericles now led 5000 hoplites and 50 ships of war to Euboea, subdued the island completely, and placed in Oreus and the district of Chalcis thousands of new Attic settlers. At Sparta there was the greatest resentment against the generals who had been bribed. Both were banished. Pericles and his agents, however, were successful in arranging a treaty of peace with Sparta, though only on terms distinctly disadvantageous to Athens. Except Plataea, Naupactus, and the supremacy over Aegina, Athens gave up all advantages won within the last dozen years, especially all possessions in the Peloponnese. Even Pegae and Nisaea were restored to Megara, against whose faithless people the Athenians from this time cherished the bitterest hate. Thus was bought the 'Thirty Years' Peace, during which all differences were to be settled by arbitration. Sparta formally recognized Athens and her confederation as a political group, and Athens in turn recognized the Spartan alliance. Neither league was to enlarge itself at the expense of the other, and defection from the proper head of the one was to receive no support from the other. But any state that did not belong to either was at liberty to join one or the other. The year 445 B.C. marks, therefore, an epoch in the history of Greece, inasmuch as by this treaty for the first time national dualism is openly recognized and proclaimed.

It had been shown that Athens's power was not sufficient at the same time to dominate the Greek seas and to maintain the supremacy on the mainland. It was further evident that on the mainland the aristocratic elements were too strong, sympathy for Sparta and aversion to Athens and her democracy too prevalent, to permit Athens to hope to supplant Sparta in her old position. Under these circumstances Athens confined herself more and more to her maritime interests. Still the Boeotians and Peloponnesians never forgave the Athenians for the short intoxication of a sway of almost Pan-Hellenic character, nor for the destruction of the navy of Aegina. The maritime states of the Peloponnese, and the patrician governments from Locris to Tænaron, were consumed with jealousy when they saw how Athens after 445 continued to develop more and more brilliantly in the domain that remained to her. It did not help the Athenians that they systematically avoided all conflicts with the continental states of Greece. This unfortunate attitude of the Greek world must not be forgotten in the contemplation of the new splendor of Athens during the period that immediately follows; it enables us to understand the genesis of the Peloponnesian war.

After the conclusion of peace with Sparta, Pericles had a hard struggle at home in defending his administration. The conservative elements, which could now point to the inglorious and ruinous issue of the last war, to the growing dissatisfaction of all classes at the increasing preponderance of the urban element in the state, had again found an able leader in Thucydides of Alopece, son of Melesias, a universally esteemed relative of the house of Cimon. Skilful in parliamentary conflicts, he was able to unite the groups of his party that had been divided since the battle of Tanagra and Cimon's reconciliation with Pericles. His most violent attacks were directed, after the rage of the Athenians over the peace of 445 had subsided, against Pericles's policy concerning the Delian Confederation, especially his expenditure of the surplus of the federal treasury in building the splendid structures with which the city was to be adorned. This time, also, recourse was had to the ostracism; and now again (perhaps in 442) the great majority of the Athenians took sides with Pericles. From this time the conservative party retired into the background, not to become prominent again till the Peloponnesian war. Meanwhile the energy of its most violent elements found vent in intrigues. United in various clubs, or 'hetaeriae,' whose object was partly social, partly at elections and on other public occasions to assist the different leading politicians, their influence was

easily recognized later in the attacks on different personal friends of Pericles, and in the support of the demagogues who began to try their strength against him. But for some years Pericles was able to impress, in various ways and without restriction, the imperishable stamp of his influence on the city of Athens.

Under his influence, Athens became the point on which focussed the creative genius of Hellas in the most various departments of higher intellectual activity, — a school of the noblest culture, of the arts and sciences, as indeed she remained amid all her vicissitudes for nearly a thousand years afterward. If to-day the name of Athens still has a magic sound for the educated among all civilized peoples, it is largely owing to the administration of Pericles. Under his patronage, the most celebrated representatives of all departments of Greek philosophy then known came together at the foot of the Athenian Acropolis. The exchange and the conflict of the most widely differing views produced, under the influence of Socrates and his school, a new and splendid growth in Greek philosophy. Various practical studies even now took new directions, e.g., astronomy, under Meton especially; medicine, in which the school of the physicians of Croton was overshadowed by the great Hippocrates of Cos; and jurisprudence, under the influence of the requirements of the numerous courts of justice. The influence of the courts, the senate, and the assembly caused oratory to flourish, in which Pericles was reckoned an unapproachable master. As advocate, Antiphon enjoyed great fame till late in the Peloponnesian war. Under the impressions of the Persian wars and the new growth of Athenian power, as well as under the effects of the Periclean administration, historical composition produced works like that of Herodotus of Halicarnassus, who in his description of the great national struggle was the first to pass from logography to real historical composition, and later that of Thucydides. Among the poets of the fifth century was Aeschylus (525–456 B.C.), who, by the introduction of a second actor, first gave tragedy its proper form; and in his “Eumenides,” in 458, once more celebrated in magnificent style the ancient dignity of the Areopagus. An Athenian Eupatrid, he probably sympathized too closely with Athenian life as developed under Aristides and Cimon to find any real pleasure in the time of the young democracy. But the younger poet, who gave to his people the most perfect creations of the dramatic art, Sophocles (born 496 B.C., son of a well-to-do citizen) moved under the direct influence of the great statesman. His art has been called by a recent historian “the glorified expression of Periclean

Athens and of her culture." He increased the possibilities of the drama by the addition of a third actor. Aeschylus and Sophocles (Fig. 136) eclipsed the fame of the former poets, the immortal Homer excepted, even that of the great Pindar of Thebes (522–447 B.C.), who with his choral songs and hymns, with his glorification of the victors in the national games, once more intensified the ancient Doric-Aeolic spirit.



FIG. 136.—Sophocles. Ancient marble statue in the Lateran Museum, Rome. (Photograph.)

Pericles exercised a very direct influence upon architecture and the plastic arts, which, in his age, gave to the exterior of Athens the character which it bore for centuries. Athens, which had been since the advent of Pericles the greatest and strongest city of the Hellenic world, was now to be the most beautiful. The circumference of the city was nearly five miles (7912 metres), or, with the space enclosed by the Long Walls and the fortifications of the harbor, about eight leagues. The population consisted of 100,000 free-born people — including from 20,000 to 30,000 male citizens — and over 200,000 slaves. In military strength the highest point was reached when Pericles built in 440 a third Long Wall, which ran parallel with and about 550 feet south of the northern wall to the Piræus, and was intended to meet the difficulty, that neither Phalerum nor the coast between it and Munichia was fortified.

The natural centre of the upper city, the Acropolis (PLATE XIII.), continued to be the citadel, under many vicissitudes, down to the year 1827 A.D. Cimon had built on the southern and eastern side of the Acropolis, which was not naturally so strong as the steep northern side, a colossal wall, which required the throwing up of an extensive embankment on the sloping ground of the southeast corner. A comprehensive embellishment of the city proper was rendered impossible by the irregular nature of the many narrow and crooked alleys. But

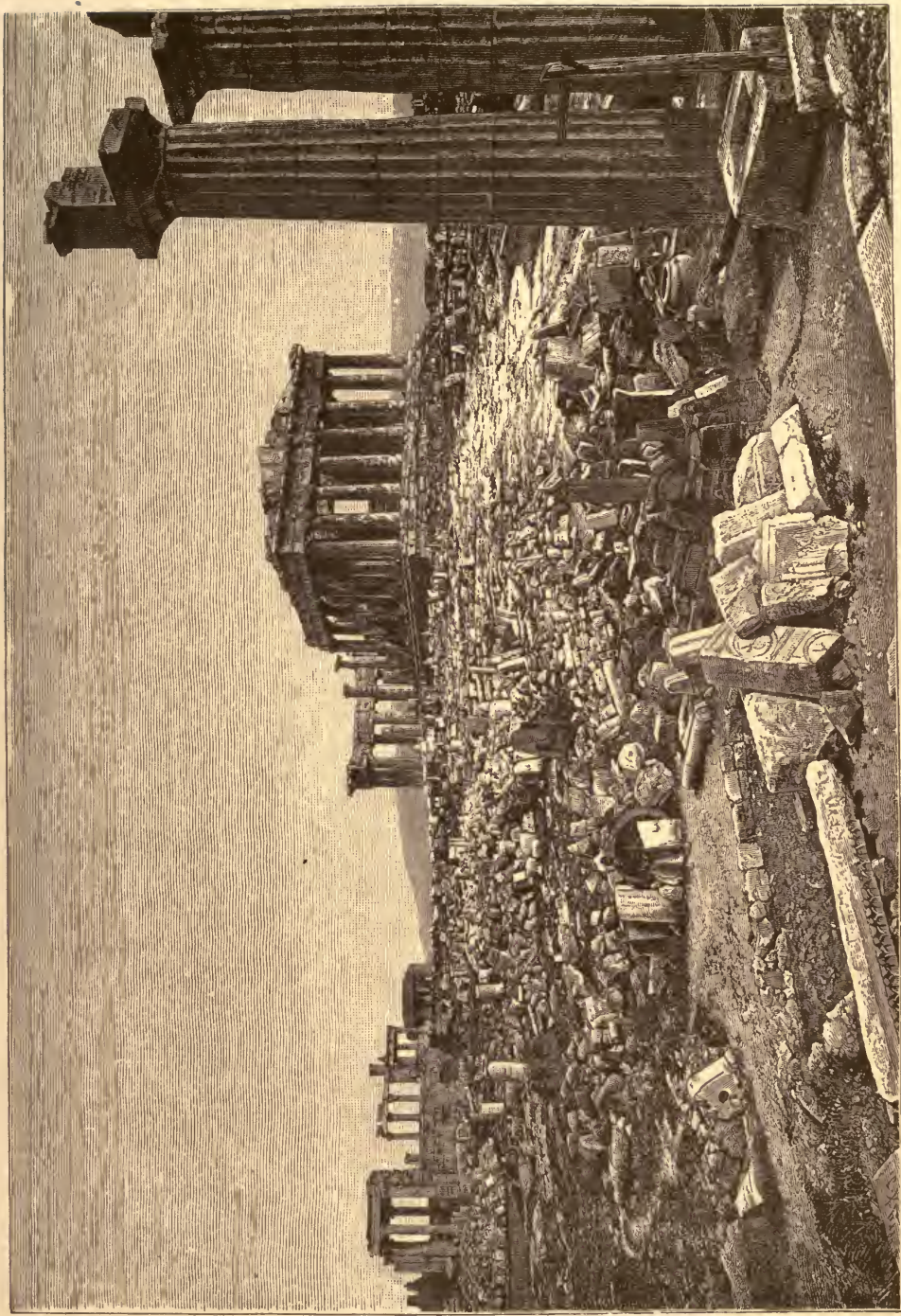

General view of the Monuments of the Acropolis of Athens. (From a photograph.)

Pericles had the new city at the Piræus carefully and artistically laid out (soon after 445) by the celebrated architect, Hippodamus of Miletus, and transformed into a really beautiful city. The port itself was surrounded by stately buildings, due in part at least to Pericles's influence. It was at once the great navy-yard of Athens, and the goal and starting-point of countless merchant ships. These latter, the instruments of a mercantile activity equalled at that time only by Carthage, were engaged in the ceaseless exchange of the products of Attic silver-mines and agriculture, of Attic art and industry, for the



FIG. 137.—Temple of Athena at Sunium. (From a photograph.)

corn of the Bosphorus, Egypt, and Sicily, the raw products of Thrace, Macedonia, and Italy, the metal wares of the Etruscans, and the products of the industry of the Orient. Ship-houses, wharves, docks, magazines, arsenals, formed the necessary outfit of the great harbor. The environs of Athens were now to be made more attractive, and structures erected on the Acropolis which should mark Athens as the capital of a proud empire. To this period belong the new temple of Pallas Athena¹ on the southern cape of Sunium (Fig. 137); the temple of Nemesis, near Rhamnus, on the strait of Euboea, north of Marathon, with the marble statue of the goddess; and above all the sanctuary of Demeter at Eleusis, the rebuilding of which was begun under the

¹ A recently found inscription indicates that this was a temple of Poseidon.

superintendence of Ictinus, and completed by the cupola of Xenocles. Cimon had already begun to beautify the immediate environs of the city in another way, namely by turning the place called the 'Academy,' northwest of the city, where one of the gymnasia was situated, into a charming park. Pericles now caused the gymnasium called Lyceum, on the more quiet east side of the city, and south of Lycabettus, to be fitted out in like splendid style. In the city, Cimon had begun the works which Pericles now continued. The Agora, or chief market, in 'the inner Ceramicus,' at the northern foot of Mars' Hill, directly north of the ascent to the Acropolis, was adorned on the south side



FIG. 138. — So-called Temple of Theseus from the northwest side. (From photograph.)

by Cimon with stately plane-trees, and it was probably at his suggestion that various Ionic porticos were erected along the sides of the Agora. The largest and most beautiful of these porticos, on the east side of the market, was built by Cimon's brother-in-law, Pisianax, and from its fresco paintings—including the battle of Marathon by Polygnotus—was called the Pœcilé. Not far from the Agora, and more to the northwest, stood a beautiful temple (Fig. 138), now popularly known as the Theseum, but probably a temple of Hephaestus and Athena, built of Pentelic marble about 440 B.C. It is the best preserved of all Greek temples. To the time of Cimon belonged, on the Acropolis especially, the colossal bronze statue of Athena Promachus, which was made by Phidias

230¹



The Parthenon, viewed from the roof of the Propylaea. (From a photograph.)

230²

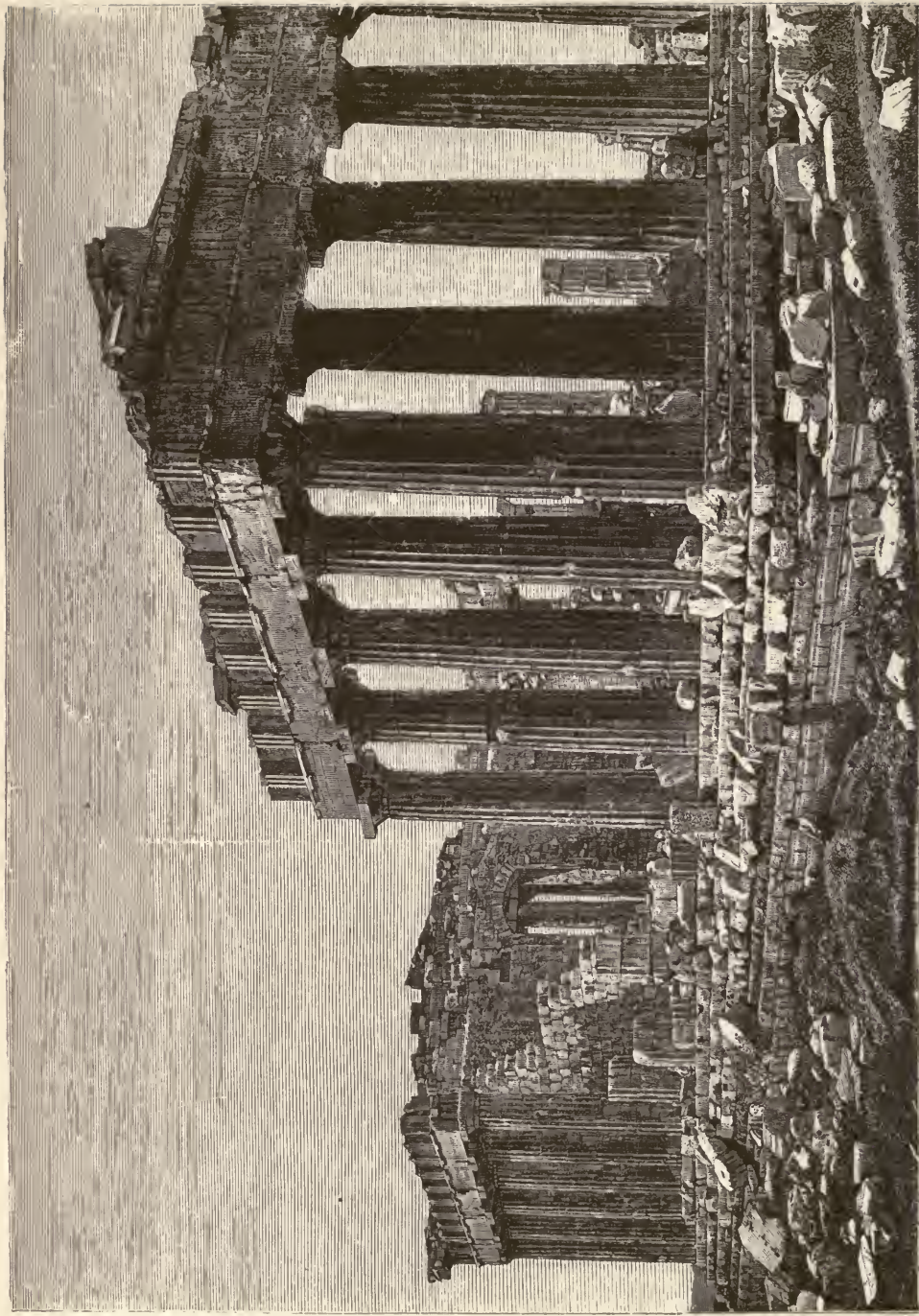

The south side of the Parthénon. (From a photograph.)

from the booty of the Persian war, and stood under the open sky between the gates of the Acropolis and the Erechtheum, rising to the height of twenty-five (with the pedestal thirty) feet. The golden point of her lance could be seen by seafarers as they sailed up from Cape Sunium.

Pericles had chosen the Acropolis as the special field of work for himself and the artists attached to him. The most brilliant of the latter, the Athenian Phidias (born about 495 B.C.), appears to have been, like the great artists of the Italian Renaissance, a man acquainted with various arts, and of the most extensive culture. At first a painter, he won his greatest fame, as pupil of the celebrated Ageladas of Argos, by his immortal works in sculpture. In all branches of this art a master, he had at the same time such knowledge of architecture that he became the most trusted adviser of Pericles. The architects and sculptors, who at this time created a new school of art in Athens, made great progress by the union of the Ionic and Doric styles of architecture, and by breaking away from the typical forms and stiffness which had hitherto prevailed; but Phidias was personally invaluable to Pericles, being a sort of minister of public works and art, and having under his direction the greatest masters, to whom the special execution of the different works was confided. The first completed work of this period seems to have been the Odeum (finished before 444), which was situated at the base of the eastern declivity of the Acropolis, and intended for the musical performances at the Panathenaea. But the most important new structures were those on the Acropolis, and the most magnificent building ever reared on this classic spot was the Parthenon (PLATES XIV., XV., Fig. 139). The so-called Hecatompedon of Pisistratus had been destroyed by the Persians; and Pericles conceived the plan of restoring this structure in new and splendid style. An attempt had previously been made, perhaps by Cimon, to replace this building by a new temple on the site afterward occupied by the Parthenon, but for some unknown reason work upon it was discontinued soon after the foundations were laid. Under Pericles the new temple was soon begun, and its splendid ruins testify even to-day to the ideal height to which Phidias and his associates had developed Attic art. It was constructed under the direction of Phidias, by Ictinus, the architect of the Eleusinian temple. From the year 447 the Parthenon was pushed forward rapidly, and in 438 completed. In its perfect state it amazed contemporaries, and generations of Greeks and Romans in after times admired it. It was a Doric eight-columned peripterus; i.e., it had eight Doric columns on the fronts and seventeen

on each of the sides (counting the corner columns twice). Built of white Pentelic marble, which in the course of time gradually became of a golden-brownish color, it measured from the lowest step to the summit of the roof 69 feet, in breadth 101 feet, and in length 228 feet on the top step. On the east side there was a shallow pronaos with six columns; from this a high bronze door led into the regular cella of the Parthenon, which was 100 Attic feet deep, and filled with costly votive presents. Its noblest ornament was the colossal statue

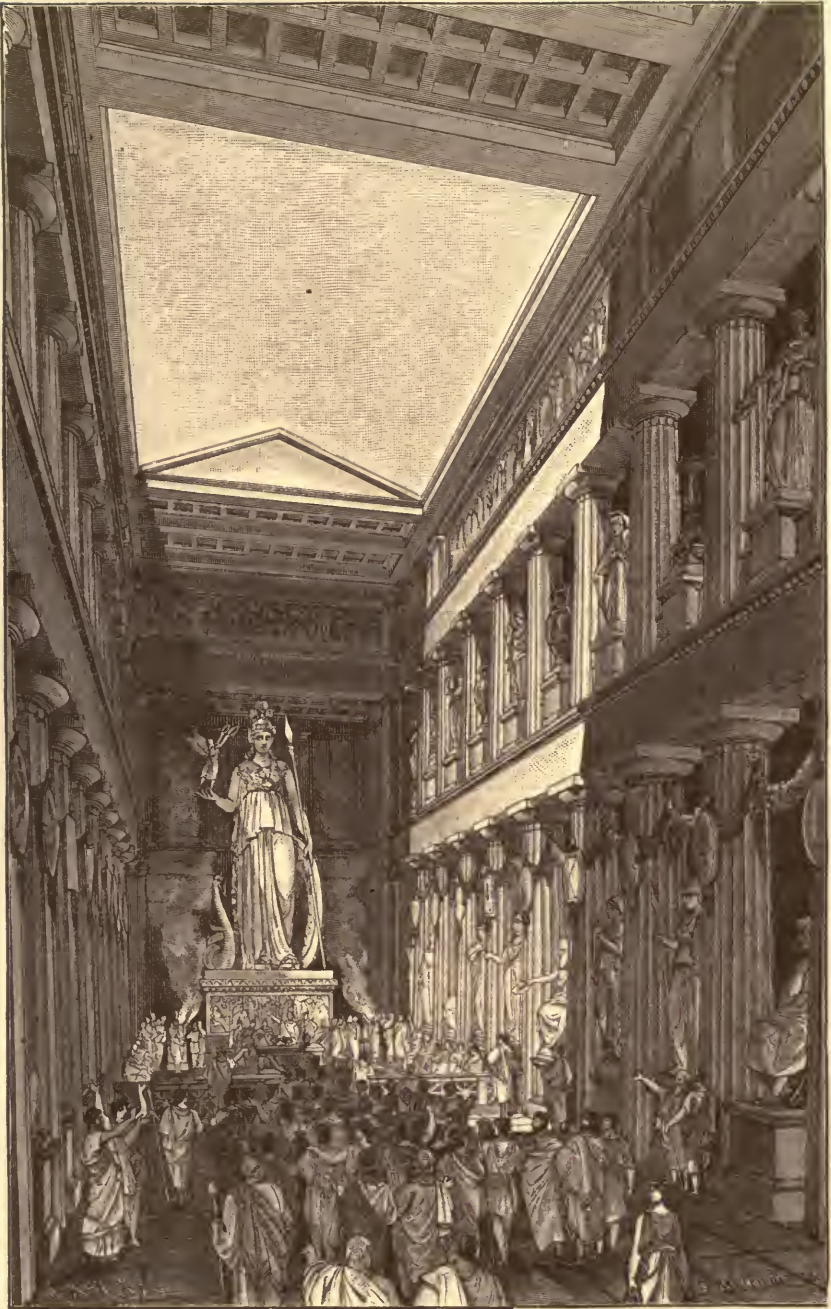

FIG. 139.—The Posticum of the Parthenon.

(39 feet high) of Athena (PLATE XVI.), made by Phidias, of gold and ivory, with the completion of which in 438 B.C. the work on the Parthenon was ended.¹ The space adjoining the cella on the west, the so-called Opisthodomus, with four columns, served as a treasury. The pediments and the 92 metopes of the outer frieze represented mythological scenes; but the celebrated frieze over the walls of the temple represented in bas-relief, covering a space about 525 feet long, the Panathenaic procession (Figs. 140, 141).

¹ An inscription has been found which shows that the commissioners who had charge of the work were still in office in 432.

PLATE XVI.



The Cella of the Parthenon, with the colossal statue of Pallas Athena, by Phidias. (Restoration by G. Rehlender.)



FIGS. 140, 141. — Two Groups of Sculptures. From the Frieze of the Parthenon. (British Museum.)



FIG. 142. — The Propylaea, entrance to the Acropolis; view from the southeast side. (From a photograph.)



FIG. 143. — The Propylaea and the Pinacotheca. (From a photograph.)

The real entrance to the interior of the Acropolis was the Propylaea (Figs. 142-144), the new gateway of Pentelic marble, 300 feet from the Parthenon, erected by the architect Mnesicles, 437-432 B.C. It consisted of a middle hall and two wings of unequal size. The middle structure formed the entrance; one passed through a row of Doric columns with temple-shaped gable into a hall fifty feet deep, with six Ionic columns where a cross-wall with five doors barred the entrance to the Acropolis. Through these one passed by way of a six-columned Doric hall into the court of the Acropolis. Immediately after — possibly before — the completion of the sanctuary of Athena, it was deter-



FIG. 144. — Interior View of the Propylaea. (From a photograph.)

mined to reshape entirely the western declivity of the Acropolis. The immense Niké-bastion at the end of the south wall of the Acropolis, which commanded the entrance to the citadel, was cut down to its present dimensions, and adorned with a beautiful Ionic temple of Athena Niké (Apteros), or of Victory. How this weakening of the fortifications of the west side was made good is still a matter of dispute. The last new structure undertaken here by Pericles was the restoration of the oldest sanctuary destroyed by the Persians, the ancient place of worship of Athena Polias, the so-called Erechtheum (Figs. 146, 147), north of the Parthenon, the ancient olive-tree of Athena, and the fountain of Posidon. The disturbances of the Pelo-



FIG. 145. — Temple of Athena Niké (Apteros). (From a photograph.)

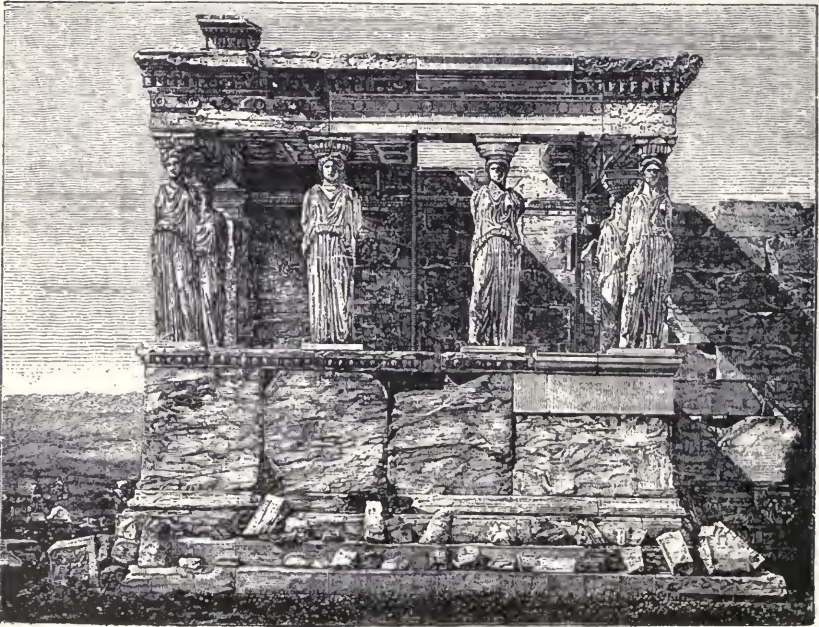

FIG. 146. — Southern Porch of the Erechtheum. The Porch of the Maidens (Caryatides). (From a photograph.)

ponnesian War, however, interfered with the progress of the building, which was not completed until 408 B.C.

The growing hate of most of the Hellenes for the capital of the Delian alliance could not hinder Attic art, at least, from winning new triumphs even in the Peloponnese and in other parts of Greece. Phidias and other Attic artists were invited about 435¹ to adorn with sculpture the great Pan-Hellenic sanctuary at Olympia (plan, Fig. 149);² and here he completed (before 432) his great masterpiece, the sitting figure



FIG. 147. — The Erechtheum. From the East. (Photograph.)

of the Olympian Zeus. This wonderfully majestic colossal statue, made of gold and ivory, about thirty-seven feet in height, remained until near the end of the fourth century of our era, a visible proof to the ancient world of the artistic greatness of the Periclean age (cf. Figs. 66, 148). Ictinus was called, after the first storms of the Peloponnesian war had died away (probably in 419), to the Arcadian Phigalia, to

¹ According to a recent view the work of Phidias in Olympia antedated his plastic work on the Parthenon, and his death (see below) occurred directly after 438 B.C.

² The Olympic Temple, a Doric peripterus, measured on the stylobate or flat surface of the highest step 91 feet in width, 210 in length, and 66 to the summit of the roof. Each front was adorned by six, and the sides by thirteen columns (each column 34.22 feet high).

build in a sublime forest solitude, near the village of Bassae, a splendid temple to Apollo, who had rescued this valley from a terrible pestilence. This temple is still in part preserved (PLATE XVII.).

The great creations of Pericles required very considerable sums of money. A modern estimate reckons the costs of all the various public works constructed at his suggestion in Attica after B.C. 448 at about 6300 talents (or nearly \$7,000,000), a sum which, according to present money values, would be increased three- or four-fold. The money was at hand in great abundance. The yearly revenues of the Athenian empire — comprising about 300 states and cities — may be estimated for that time at about 1000 talents (over \$1,000,000), of which about 400 talents were specifically Attic revenues, derived especially from



FIG. 148. — Elean Coin of Hadrian's time. — Coin with the Head of the Olympian Zeus.

custom duties and privileges, and from the products of the Laurian silver-mines and the Thracian gold-mines. About 600 talents came from the federal taxes and tribute;¹ and the surplus went into the federal treasury, which by B.C. 438 contained 9700 talents, but the amount decreased considerably afterwards. Pericles expended on his great public works, first the surplus of the purely Athenian revenues over the regular expenses of the government; later (especially after 445), partly a certain proportion of the current

federal tribute, partly larger sums from the federal treasury which were applied to the same purpose. But the possibility of applying federal means to Athenian public works was the result, first, of the continued peace with Persia, whereby the activity of the Attic-Ionic fleet was limited to yearly manoeuvring expeditions in Greek waters, and to maintaining an excellent maritime police; second, of the gradual change of the Athenian hegemony into a relation which, for most of the allies, differed little from a thinly veiled sovereign authority. When the federal treasury was transferred from Delos to Athens in 454, the synod of the alliance was also transplanted thither. As the management of federal matters took on more and more an essentially Athenian character, most of the allies probably neglected to attend the synod, while its proceedings were merely formal. The change from contingents of ships

¹ The extension of the alliance had since about 465 increased the annual federal revenues to 460 talents. Later, especially after 454, when the contributions in kind had been in effect replaced by money payments, these revenues gradually increased, although there was no lack of reductions of federal taxes by decree of the Athenians.



Temple of Apollo at Phigalia; Mt. Ithome in the distance.
(From a photograph.)

and men to contributions of money had become so general that after 454 only the great insular states, such as Samos, Chios, and Lesbos, which were in return entirely relieved of taxes, maintained fleets and crews of their own for federal purposes. Athens thus became the capital of an empire dominated as well as protected by its fleet, while the most of the allies appear as tribute-paying subjects.

Pericles maintained, with full conviction and in open conflict with the conservative party at Athens, the principle that, while the Confederation of Delos was established for the protection of all allies against the Persians, and the members of the alliance had the full right to demand this protection from the Athenians, on the other hand, so long as Athens fulfilled this duty, and did it by the maintenance of a great fleet, and by the whole power of the Athenian empire, so long had the Athenians the free disposition of the federal revenues in taxes and tribute. It is to be considered also that not a few of his public works, apart from the strengthening of the fortifications of the capital, partly served directly the purposes of the alliance, — e.g., the Parthenon was a federal treasure-house, — partly stood in indirect relation to the alliance and the proper worship of the federal goddess, Athena. It was a much greater annoyance to all elements in the allied cities that placed a high value upon autonomy, especially to the aristocratic and timocratic elements, that the Athenians gradually compelled most of the allied cities to renounce higher legal jurisdiction, and have all important processes tried before the Attic dicasteries. First, probably with the decay of the federal synod, the right fell to Athens, as leading power, and to the Attic courts, of deciding the frequently occurring quarrels between the different members of the alliance. Next, the right of adjudging independently the death penalty, even against their own citizens, seems to have been withdrawn from the subject places, and a preliminary investigation and sentence at Athens became necessary. Finally, it seems, only the lower courts remained usually in the hands of the allies. From our modern point of view it may be presumed that the transfer of the higher courts had in the main a good effect. That this relation could be, and prob-

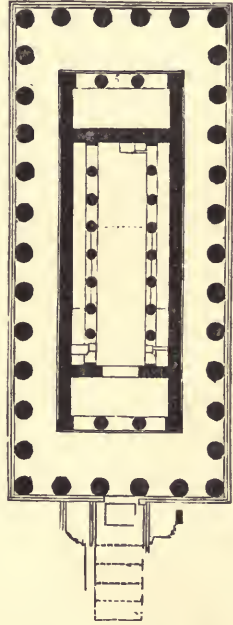

FIG. 149. — Plan of Temple of Zeus at Olympia.

ably often was, misused by Athens is not to be disputed. But, on the whole, with the passionate disposition and the party factions of the Greeks, it was certainly very well that most of the small cities were deprived of the right of passing sentence in the matter of property or of life upon their citizens.

In its present extension, divided into a number of taxing districts, — the Carian, with Lycia, comprising 68 cities; the Ionian, with southern Aeolis, 36; the Hellespontic, with Aeolis, Propontis, and Bosphorus, 44; the Macedonian and Thracian, 61; and the Island district, 28, — the Confederation of Delos was the real basis of the political and mercantile greatness of Athens. Yet it was evident that the foundations of Athenian power could not endure serious military disaster; for the desire to recover full autonomy was ineradicable in Greek minds. The opposition of many allies to the earlier contributions in kind attached unavoidably to the taxes which took the place of the former. The planting of cleruchies, or colonies of Athenian citizens, on the various islands that had revolted and been subdued, gave offence likewise. But insurrectionary sentiments were nourished in the main only by the patricians; as a rule, the commons in the several cities were well disposed to the Athenians, partly on account of the similar form of the constitution, but still more because of the profitable trade with the capital, and the great advantages of the federal flag for merchants and seafarers. All desires for revolt seemed permanently checked when an uprising of the strongest allies was put down. Samos, the most independent and powerful member of the alliance, had got into a dispute with Miletus about Priene, then into open war (B.C. 440), and declined to submit to Athenian arbitration. Pericles, with forty ships, now interfered; Samos received an Attic garrison and a democratic constitution, and a hundred hostages were taken to Lemnos. But scarcely had Pericles reached Athens before Samos was again in open revolt. Secretly supported by the Persian satrap in Sardis, Pissuthnes, the Samian aristocracy renounced their allegiance to the alliance. Pericles resumed the conflict with great energy. Athenian perseverance and superior military resources brought the Samians in the summer of 439, after a hard conflict, into complete subjection. They had to give up their fleet, change their constitution to suit the wishes of the Athenians, and allow the island of Amorgos, which had hitherto been subject to them, to enter the list of the immediate allies of Athens. The Samian war had cost 1276 talents, and still more serious was the fact that during this war the Samians had asked in Sparta

for help against Athens, and only Corinth's fidelity to the treaty had finally caused the Peloponnesians to refuse the help. Pericles could not fail to note that there was little prospect that peace would be preserved with the Spartan league for the stipulated thirty years, and to feel, in consequence, that it was his duty duly to prepare Athens for the inevitable death-struggle. To this task he devoted himself during his few remaining years. He greatly strengthened the military and mercantile position of the Athenian empire by founding Amphipolis at the most important strategical point on the Thracian-Macedonian coast, one league above the mouth of the Strymon and the port of Eion (437 B.C.). Besides, numerous Athenian cleruchies were established at points conquered directly for the state: e.g., on Seyros, Imbros, Lemnos, and (452) on the Thracian Chersonese; on the territory of conquered allies — for example, on Euboea, Naxos, and other islands, as well as within the bounds of friendly states, where the land was obtained by purchase. The finances were managed with care and economy. Notwithstanding the costly buildings and other expenses, Pericles was able to lay up, from the surplus of the federal revenue, a sum which, after the completion of the works finished by B.C. 432, and after the recapture of Potidaea in 429, amounted to 6000 talents (over \$6,000,000), not reckoning the numerous costly votive offerings of the Acropolis, which could be coined if necessary. The fleet was kept in the best and most efficient state; the arsenals were filled with weapons and war supplies of every kind. The best part of the war force, the troops to be levied from Attica itself, were excellent; but, unfortunately, they were by no means numerous, even for wars in Greece. With 300 sea-worthy triremes, Athens could at this time raise (from about 21,000 full citizens of all classes and numerous *Metoei*, who shared the service) 1200 horsemen, 1600 bowmen, and 13,000 citizen-hoplites for active service, besides 16,000 men capable of bearing arms (among these 3000 hoplites of the *Metoei*) for guard and garrison duty, when not required on shipboard.

But unfortunately a worthy successor to the line of great statesmen who had hitherto guided Athenian policy was wanting. It was not until much later, it is true, that there was a lack at Athens of able generals and of excellent politicians of the second and third rank. But men like Themistocles, Pericles, and, in the next century, Demosthenes, are born, not made at pleasure. The new generation of politicians included mostly men of the middle class, who personally stood much nearer to the commons than had patricians like Pericles and Cimon. This in itself

was not an evil; but it was a most baneful fact that these new leaders shared all the prejudices and all the superstition of the masses, and developed a wild radicalism, which made them savage assailants of Pericles (Fig. 150), and promised little good for the future. So the fateful question remained, Who should in future rightly direct the splendid powers which had now reached maturity in Athens, but which showed also various dark sides? The commons, or Demos, under Pericles represented an imposing appearance. The citizens were intelligent to a high degree; they were, in the main, true to a proved leadership; they were well qualified for a debate in their Boulé as well as in their popular assemblies. Their dicasts performed the duties and bore the burdens of the courts not only willingly, but as a rule with insight and judgment. The Athenian was above all other Hellenes susceptible to great ideas and ideal thoughts. Restless, ambitious, alert to everything new, the Athenians of this period displayed an astonishing activity, an incomparably persistent energy, and submitted at the same time to very strict discipline. But there were not wanting evil influences. Apart from the danger that the feeling of power might seduce them to engage in undertakings that were enticing, eccentric, or of uncertain issue, there was a still more hazardous possibility that the influence of demagogues of lower rank and doubtful character might some day change the new democracy into a despotic rule of the masses (with 'ochlocratic' character), and press hard upon the conservative and aristocratic elements of the people. Besides, there was the danger that the strongly developed taste for litigation might grow into a passion, and degenerate into a base tendency to use the courts as a political weapon against unpopular citizens and suspected allies.

The development of public life called forth further a new phenomenon, whose effect was in many ways unwholesome, and which added to the existing political elements of discord a new and more intellectual one, the influence of the so-called Sophists. From the schools of the Greek philosophers, who applied their scepticism to nature, religion, the whole sum of traditional ideas in the world of thought as well as in that of action, there had sprung up, first in the Ionian Siceliote and Italiote cities, representatives of the modern enlightenment of unrest, which proposed to subject everything existing to the test of reason and philosophy. Various new rational or doctrinary theories about the state and the civil status of citizens, independent of historical development, were proposed and explained. These so-called Sophists were highly cultivated men, who despised the contradictory systems of the different philo-



Fig. 150.—Antique marble bust of Pericles, as strategus. Traceable to an original by Cresilas. (British Museum.)

sophical schools, and sought rather to prove from these contradictions the impossibility of a knowledge valid for all. They displayed a two-fold activity as teachers. As the medium of all modern culture and of the intellectual progress of the time, they were able to widen considerably the intellectual horizon of their hearers. Besides their great importance for the development of Attic prose, their readiness in thinking and speaking, their habit of discussing with perfect freedom all questions, from all sides, for and against, made them welcome teachers, especially for the young Athenians, who, on account of the increasing importance of rhetorical skill, wished to acquire the mental training, readiness, and fluency that were necessary for the business of the dicasteries. It was inevitable that the lack of all valuable thought in the sophistic training, and the new habit on the part of the young Athenians of discussing all existing moral, social, and political relations from purely subjective points of view, would work harm in many ways. The new art of asserting the right of the individual as over against the public, regardless of consequences, and the disorganizing principle of sophistic criticism, stood in sharp contrast to the old Athenian character. But as the Athenian youth, of the higher classes, in particular, grouped themselves about the Sophists, a new and sharp distinction was developed between these and the mass of the people, who observed with indignation that the caustic, destructive criticism of the sophistically trained minority was directed with peculiar relish against the many comic phases of popular activity, and especially against the existing democracy. This opposition of the young aristocracy to the commons, based on the ground of higher culture, was at first ironical, then openly hostile. Even the dialectic school of the great Attic opponent of the Sophists, Socrates, who opposed to their formalism a new intellectual system and profound moral ideas, was seen to raise up no friends for the democracy. As, further, sophistic culture very evidently weakened the attachment of many to the old popular religion, the Sophists became more and more unpopular with the mass of the people, who, besides clinging to the old Greek ideas, were displeased that they made moral and intellectual teaching a source of profit. As the common folk in their stubborn, often bigoted, conservatism, made no distinction between earnest philosophers and sophistic dialecticians, all new theories that were in any way directed against the spirit as well as against the traditional forms of Greek popular belief were especially repugnant to them.

The position of Pericles, during the time immediately preceding the outbreak of the new Pan-Hellenic war, had gradually become less

secure. Before his strength of mind and power of speech everything seemed still to bend. His absolute devotion to the public service, his simplicity, his honesty in money matters, his strict mode of life, were unassailable. His political position seemed to be so. He exercised the strongest influence on the administration of the finances, especially by causing the most important financial offices, such as he did not himself manage, to be filled with able men devoted to him and to his ideas. Personally he filled for many years, without interruption, the most important of the elective offices at that time, that of first strategus, or general. For this position not only was required extensive military and financial ability, but to it was committed the control of foreign affairs and diplomatic intercourse with foreign states, as well as the right to summon the popular assembly, or in critical junctures to forbid its coming together. Besides, Pericles repeatedly filled the office of superintendent of public works, as well as that of manager of the great Attic democratic festivals. It was, however, inevitable that the extent of his power and his system of administration should always find new opponents. The greatness of his personality angered too many not to sharpen continually the weapons of those who were ready to attack him with all the resources available in a democratic state. Thus, the Attic comic poets had long been assailing him with increasing vehemence.

Greek comedy, like tragedy, had grown out of the festivals of Dionysus. The rough buffoonery of the country, which had gradually developed out of the merry scenes of the vintage, was in the early part of the fifth century transplanted to the city, and here transformed into a new species of Attic dramatic art, which in matter and form stood always in the closest conceivable relation to the history of the time and to the daily life of the Athenians, — in the ruthless freedom of its mockery a legitimate outgrowth of democratic development. With its outspoken tendency to lash with sharp wit whatever was foolish, weak, or ridiculous in Attic life, Attic comedy of the fifth century, the creation of Crates and Cratinus, but receiving its perfect artistic form from Eupolis and Aristophanes, was as a rule on the side of the conservative party. It was directed especially against Pericles, whose 'Olympic' greatness incited it to caricature, for the mockery-loving Athenians, the weaknesses of his personality and of his situation. The Athenian practice of unrestricted freedom of speech, on the stage and elsewhere, gave comedy the right to attack unsparingly by name, not only well-known and prominent persons, but also men of less importance; and these were often caricatured with as much malice as wit.

Much worse was it that the hostility of the radical demagogues to the embittered aristocratic elements did not prevent them from uniting with these in very dangerous attacks upon Pericles. It was not, it is true, till long after the end of the Peloponnesian War that the politicians from the middle classes actually won full equality with the statesman of noble birth. But the former early appear in the rôle of 'demagogues,' stump-speakers (much after the manner of representatives of the opposition press in modern constitutional states), party leaders without public office, confining themselves to the part of voluntary accusers of officials. Although the ambition of most of these new men did not at first go beyond membership in the Boulé or one of the many offices decided by lot, still there were politicians bold enough to oppose the policy of Pericles, men who even speculated on his political inheritance. Far the most conspicuous among these at that time was Cleon, son of Cleaenetus, from the deme Cydathenaeum (south of the Acropolis) of the old city. Mockingly called the 'tanner' by his opponents, but in reality the owner of a large tannery, he was the most violent, but also the ablest, politician of the rich handicraftsmen of the middle class, and the real leader of the radical opposition. That Pericles gradually lost the favor of the radical elements is not strange. He remained a nobleman of proud, reserved, and austere bearing, and did not, like the affable Cimon, become popular by his jovial manner. His whole position seemed to many a new kind of tyranny. Besides, after the fall of Thucydides, the character of an aggressive party leader became less prominent in him, and he probably was not inclined to favor claims of the democracy beyond the limit already fixed. It was fully in accord with his views, and with the demands of the political situation, that the Attic citizen-troops, who were after B.C. 460 continually employed as hoplites and on the fleet, received compensation, which in daily pay and cost of maintenance amounted to four obols (about twelve cents) for the hoplites, twice that for officers, three times as much for cavalrymen: while the ordinary marine got on the average only three obols, and the picked men of the two Athenian government despatch boats four. But it is doubtful to what extent, if at all, Pericles had a share in the measure of Callistratus Parnytes, by which the Athenian citizen was to receive an obol for each attendance at the numerous meetings of the popular assembly. Of like nature was the introduction of the daily pay of a drachma (about twenty cents) for the members of the Boulé. How far Pericles agreed with or opposed the radical elements in the extension of such innovations is hard to determine. But

it is not wonderful that, as usual then and since, the politicians, who went farther than he did, turned the more bitterly against him in proportion as his greatness and his authority became disagreeable to them.

So at last against the common antagonist there grew up a union of oligarchs, bigoted priests, and radicals, who at a politically dangerous moment turned their attacks against men who stood near Pericles. The first effort was made against the aged Anaxagoras, who was hated for his scientific theories. He was accused of atheism, 432 B.C., shortly after a general decree had been adopted by the commons that every one was to be prosecuted as a state criminal who denied the religion of the land, or advanced new doctrines about heavenly things. Anaxagoras saved himself by fleeing to Lampsacus. Still harder was the blow that was aimed at Phidias, who, after a charge of embezzlement of gold in making the statue of Athena had failed, was accused of atheism, because he had placed in a group on the shield of Athena two figures which bore the features of himself and Pericles. Phidias was arrested¹ and thrown into prison, where he died before the process was ended. His opponents next directed their attacks against the house of Pericles, and, indeed, against his (second) wife, with whom he had lived since 445, and who was, though not by Attic law a member of the citizen class at Athens, intellectually his equal, the beautiful, highly gifted, and highly cultivated Milesian woman, Aspasia. She was accused of atheism and of playing the procuress for Pericles.² He pleaded her cause himself, and secured her acquittal. But the next blow was aimed directly at his own person. Dracontides made a motion in the Ecclesia, that Pericles should give to the prytanes, under especially solemn forms, a full account of the public moneys that had passed through his hands. On motion of Hagnon the affair was to be decided by a jury of 1500, to whose judgment it was left, so general did the crafty mover make it, whether trial should be instituted for embezzlement, bribery, or quite generally for transgression of the law. This attack, also, made early in 431, which was probably intended to force a public statement of various expenditures which Pericles had made "for necessary purposes," that is for secret, especially foreign, political ends, failed. It was not pushed, because just at this time the long-expected war with Sparta blazed up.

For several years, the smouldering fire of discord had been breaking out again at different parts of the Greek world, this time to grow into

¹ Unless the death of Phidias is to be placed earlier, see p. 229.

² Recent investigation shows that she has been wrongly classed among the Hetaerae.

a great conflagration. The immediate cause of conflict was a struggle between the commonalty and patricians, in the Coreyean colony of Epidamnus on the Illyrian coast. The commons having appealed in vain to Coreyra for help, turned to Corinth. Here the appeal found a ready hearing, since Corinth wished to regain her old position among the Greeks of the west, and troops and fresh settlers were immediately despatched. But the jealous Coreyreans now took up arms and demanded the withdrawal of the Corinthians from Epidamnus, and blockaded the city. Thus war arose between the two kindred Dorian states. When, at the end of the year B.C. 435 or the beginning of 434, the Coreyreans had beaten a Corinthian fleet, and forced Epidamnus to capitulate, and Corinth was making immense preparations, the Coreyreans thought to secure the help of the Athenians by availing themselves of the clause in the treaty of 445, which allowed any independent Greek state to join at pleasure the Attic or the Peloponnesian alliance. Now, however, it was clear that, notwithstanding this clause, an alliance of the Athenians with Coreyra would probably involve the former in war with Corinth and thereby also with the Peloponnesian league. But in spite of this, and in spite of the strong opposition of the Corinthian ambassadors, Pericles and the Athenian commons could neither allow Corinth to overthrow Coreyra, nor renounce the advantages to be derived from the addition of the Coreyrean fleet to the Attic. They concluded, therefore, with Coreyra not a general alliance or symmarchy, but an 'epimachy,' an alliance which bound both sides only to mutual protection. First the Athenians sent (end of July, 434) a squadron of ten ships to do guard duty in the Ionian Sea. Under these circumstances Corinth made greater preparations, and fought in September, 433, with 150 triremes against 110 Coreyrean ships, a great battle at the Sybota Islands, which the Athenian vessels, having been sent only to protect Coreyra, did not at first engage in. In a hard struggle the Corinthians had won a very considerable advantage, and were already preparing to strike the last blow against their shattered antagonists, when suddenly twenty new Athenian ships appeared. At sight of these the Corinthians gave up the conflict, but, aided by the Aeginetans, began everywhere to stir up war against Athens. While Sparta still hesitated, a new conflict broke out in the north, which involved Athens and Corinth indirectly. The Corinthian colony of Potidaea, which, although a member of the Delian alliance, annually received its highest magistrates from Corinth, was required by the Athenians, who now considered themselves at war with the Corinthians, to pull down

its city walls on the side next the sea, and give up its connection with Corinth. The Athenians were the more unyielding, as the King of Macedonia, Perdiccas II., who, after his father Alexander's death (454), had gradually made himself sole ruler at the expense of his brothers, was working against Athens at Corinth, as well as stirring up discontent among the cities of the Attic alliance on his coasts. The Athenians had already sent an army against Perdiccas, when in the spring of 432 Potidaea openly revolted from Athens; the Bottiaean and the citizens of many smaller cities of Chalcidice, under Macedonian influence, followed her example, and at the suggestion of Perdiccas assembled in Olynthus. Athens now opened the war against Perdiccas, while Corinth threw 2000 men into Potidaea. The Athenians thereupon sent new troops to Macedonia, and turned with all their might against Potidaea, under whose walls they won, late in the summer of 432, a victory over the Potidaeans, Corinthians, and Perdiccas, and laid siege to the city.

Now, however, the Corinthians vehemently urged at Sparta a general war against Athens. The rulers of the Spartans first called on all who had charges against Athens, to bring them forward (late in 432). Especially loud were the complaints of the Megarians. The hate which the Athenians had cherished since 446 against their tricky neighbors had lately led them, it seems, to take advantage of some local disputes, and on motion of Charinus, a confidant of Pericles, to forbid the Megarians, on pain of death, all trade and intercourse with Athens and with all ports of the Athenian alliance. This was meant to ruin the Megarians, whose main support was their trade with Athens. The popular assembly of the Spartans, in November or December, 432, which was to determine, first, whether there was real ground for war with Athens, decided for war under the influence of the stinging speeches of the Corinthian ambassadors, and against the advice of the aged King Archidamus. The Delphic Pythia, too, added her voice; and the synod of the allies that was summoned to Sparta was induced by the Corinthian and Spartan war-party, which did not wish any understanding with Athens and hoped easily to break her power, to give likewise a majority for war. While preparations were being made everywhere against Athens, Sparta sought, by a diplomatic ruse, to bring the Athenians into the wrong. Probably in collusion with Athenian opponents of Pericles, who wished him removed at any cost, they called upon the Athenians to purge away the ancient Cylonian guilt, and to drive from the city the guilty Alcmeonidae, to whom Pericles belonged on his

mother's side. When this demand was met only by the counter-demand that the Spartans should first purge themselves of the sacrileges committed in their own land, Sparta made three political demands that encroached directly on Athens's power,—to give up the siege of Potidaea, restore the independence of Aegina, and repeal the decree against Megara. When these demands also were quietly and rightfully refused, the Spartans pronounced their ultimatum: Athens must restore the independence of her allies. This was decisive. Pericles, whose opponents began to play the *rôle* of peace-party, now considered the conflict unavoidable, and convinced the Athenians, in earnest deliberation, that the war thus forced upon Athens must be accepted, and that the prospects of success were on their side. They might, indeed, declare themselves ready to submit all points of dispute to arbitration, in accordance with the terms of the treaty; they might even restore autonomy to their allies who were independent at the time of the last treaty of peace; but in that case the Spartans must do the same for the Peloponnesians. They must expect the conflict, in order to repel it with vigor. Thus all the bridges were broken down. Early in B.C. 431, then, war was on all sides determined on. Athens was anxiously awaiting the first blow of the Peloponnesians, when Thebes of her own accord opened the war by a sudden attack upon Plataea, Athens's faithful ally. The attempt failed; and before Athens could prevent it, the captured Thebans were killed in a manner as cruel as it was foolish. The whole episode prefigured the spirit in which the new Peloponnesian War was to be waged.

PART IV.

FROM THE BEGINNING OF THE PELOPONNESIAN WAR TO THE BATTLE OF MANTINEA.

(431-362 B.C.)

CHAPTER XII.

THE PELOPONNESIAN WAR.

WHEN the war had been opened by the bloody scenes at Plataea few certainly of the Hellenes believed that the contest would last twenty-seven years. On the contrary, both leading powers hoped to be able soon to force their enemies to accept such a peace as accorded with their wishes and interests. From the beginning, the plans of the Spartans were far more wide-reaching and much more malicious toward Athens, than *vice versa*; and in many points of the greatest importance the situation of the Athenians was decidedly more unfavorable than that of their enemies. The plans of the Spartan war-party and of their allies all looked to the destruction of the power of Athens, and to securing for Sparta the hegemony of all Greece. They were aided by a wide-spread jealousy and by the hate of almost all the Greek aristocratic communities for the Athenian democracy; and it was indeed a strong card which they played against Athens, in the demand to restore independence to all members of the Delian alliance. Public opinion now saw in the red cloaks of Laconia only the saviours of Greece from a hard despotism; and stormy hopes awoke, not in Aegina and Potidaea alone, of the speedy victory of the principle of local independence. The Spartans had these further advantages,—in Attica a not inconsiderable party had accepted the war unwillingly, and the artificial structure of Athenian power could be shattered from Sparta much more easily than that of Sparta from Athens. The Peloponnesian war-party hoped

at first to overthrow the Athenians in a few campaigns; they had no conception of Athens's power of resistance, nor did they gain it even after the Syracusan catastrophe. The Spartans depended on the large heavy-armed force which the Peloponnesians could furnish; they reckoned on the excellent warriors of Boeotia, at that time the most irreconcilable of all the enemies of Athens, with whom, too, now stood the Opuntian Locrians, and even the Phocians. In view of the 60,000 picked men which their alliance could easily raise, it is very clear how the Spartans came to begin by a violent attack upon the central position of the Athenians; for it was likely that the latter, when they saw their rich land laid waste, would accept battle, in which the Spartans would almost certainly win a victory that would give the allies and subjects of the Athenians courage to revolt. But when this calculation failed, the Peloponnesian military authorities were confounded; and a time of uncertain experiments began, as well as of underhand treating with Persia for help against Athens,—things which did not lead to success until the Spartans had learned generalship from their opponents themselves, had secured the aid of an Athenian traitor, and finally had found means to oppose the Athenians effectively on the element where the latter had so long been undisputed masters.

The situation of the Athenians, on the other hand, was always far more precarious than that of their enemies. With the exception of Argos, and of the Thessalians, who had lately become again friendly to them, and also of a few states and tribes of minor importance, the whole Greek people, from Taenarum to Amphipolis, was hostile to them. Only Plataea, Naupactus, and the Acarnanians held inflexibly to them. Their mainstay was the allied islands and coast cities of the Aegean, to which were added Coreyra, Zacynthus, and (some months after the war began) Cephallenia in the Ionian sea. With all the advantages of their organization and military experience, with their excellent fleet and material resources, the Athenians were in the main permanently restricted to waging a defensive war on a great scale, with occasional incidents of an offensive stamp. In other words, the position of their chief opponent was such that a stab to the heart could not be attempted. Pericles, who sketched the outlines which were afterwards followed by the Attic commanders until the repulse of the attacks upon the Athenian power on the eastern side of the Aegean Sea, had to resolve to abandon the territory of Attica to the enemy, in order to let them recoil from the walls of the capital, while he repaid them by blockading the harbors and ravaging the coasts of the Peloponnesians. The

Athenians were then to win points of support on different sides of the peninsula, and thus gradually so wear out their antagonists that they would finally agree to a peace favorable to Athens. As yet there could be no serious thought of breaking up the Peloponnesian alliance or laming Sparta in a military way. History shows that after the sudden death of Pericles, that part especially of his plan of war was forgotten which concerned the strict holding together of Attic resources. The Athenians repeatedly gave undue attention to the struggles on the edge of the theatre of war, with the result that the conflict was constantly spreading in new directions. Finally the unhappy idea of out-doing the Peloponnesians by a gigantic diversion led to the Sicilian catastrophe, from which Athens never recovered.

It was only natural, moreover, that at the beginning only a small number of Greeks on either side looked upon this war as a life-and-death struggle. Not only in Athens, but even in Sparta, the hate of their opponents had not become so universal and so deeply rooted as not to leave room for more peaceful thoughts. Only in the last few years, when all political and all race antitheses stood in armed array against each other, when all the civilized countries along the Mediterranean, from Carthage to the courts of the Thracian princes and to the seats of the satraps of Anatolia, had put their fleets and their land forces on the scene of action, did the fierce fratricidal hatred between the Hellenes blaze up to such height, that only the complete extinction of Athenian power would satisfy their adversaries.

At the beginning of B.C. 431 the troops of the Athenians and their allies held Potidaea closely blockaded. The Spartans, some months after the butchery of Plataea, called out their forces against Attica, two-thirds of the full Peloponnesian army and proportionate contingents from the rest of the allies. King Archidamus led this army, in June, 431, into Attica, and began the systematic laying waste of the country, which was at that time in a state of prosperity never again reached. But in vain did the Spartans hope by this means to force the Athenians to accept battle. At Pericles's command the whole country population had withdrawn into the fortifications of Athens. These walls and the other strongholds of the country were well garrisoned. But, with the exception of some skirmishing of the cavalry, Pericles — now clothed as commander-in-chief with extraordinary powers — kept the troops behind the walls. Now, however, the dissatisfaction of the landlords and peasants, who beheld with grief the destruction of their country seats, their fields, vineyards, orchards, and olive groves,

rose to a dangerous point, stimulated as it was by demagogues, such as Cleon, who jeered at the 'cowardly' conduct of the war. But Pericles held the reins firmly, and put in readiness a fleet of a hundred ships; these, as soon as the enemy had begun to retire after ravaging northern Attica for five weeks, sailed to the Peloponnese, laid waste, with the help of the Coreyreans, its west coast, and won Cephallenia for Athens. At the same time a smaller fleet ravaged the coasts of the Opuntian Locrians, and occupied and fortified the island of Atalanta. The Aeginetans were forced to abandon their island (receiving from the Spartans new homes in the Peloponnesian Thyrea), which was now occupied by Attic cleruchs. Finally, in September, Pericles fell upon Megaris, and laid waste the little district. Soon afterwards he formed a reserve fund of a thousand talents (over \$1,000,000), which should on pain of death be touched only when a hostile fleet should attack the Piræus and there should be no other means of defence. The war fever was now in full glow in Athens. Matters were still favorable, on the whole, for the Athenians, and the influence of Pericles was as yet unshaken.

At this point, however, there fell upon this brave people the first of those misfortunes before which they gradually gave way. It was a wasting pestilence, an eruptive typhus fever, which usually soon slew its victims. It had spread from the upper Nile to Egypt and Libya; then to the Asiatic provinces of the Persian empire, as well as to Rome and Sicily. From Lemnos it had reached the Piræus, then Athens itself, where everything favored its ravages. The city and its fortifications were crowded with excited people; and the sanitary condition of the fugitives from the country was in many respects unfavorable, so that Attica suffered an immense loss in human lives. The pestilence, which raged for two years without interruption, and then ceased for eighteen months, only to visit the city again for a whole year, carried off three hundred knights and nearly forty-five hundred hoplites; that is, a large part of the flower of the citizens. Of the poorer citizens and of the slave population, uncounted thousands died. These losses made great gaps, which could be only imperfectly supplied. From this time the decline of the ancient stock could not be stayed. Gradually a physical change was observable, as the aftergrowth of half-breed elements; and the *Metœci* became more and more prominent, producing a visible effect on the political spirit of the body politic. The direct effect of the pressure of the year 430 was to shake the position of Pericles. When he returned from a cruise against the east coast of the Peloponnese, he found

the people as much embittered against him personally as depressed by their sufferings. The popular leaders, Cleon, Simmias, and Lacratidas were now able to bring a successful suit against him "for bad management of the public moneys." He was suspended from his public offices, and condemned to pay a fine of fifteen talents. As he was not able to pay it, he had, for a season, as public debtor, not even the rights of an ordinary citizen. At the same time, too, the pestilence was playing havoc in his family and among his friends. But public sentiment soon changed. The Athenians soon saw that no substitute for Pericles could be found; and, as the spirit of war revived, they turned to him again. The judicial decision was repealed, his political disability removed, and he was placed for the next year again at the head of public affairs with extended powers. But he was able to attend to the duties of his new position only a short while. He lived to see Potidaea taken in the winter of 429 B.C., and occupied by Attic settlers. But while the next year the Peloponnesians avoided the pest-visited Athens, and joined instead with the Thebans in besieging the brave Plataea, while on the west side of Greece, where the conflict now also began, the excellent admiral Phormio won successes at Naupactus, and the Acarnanians fought with good fortune at their capital Stratus against Ambraciotes, Epirotes, and Spartans, Pericles, who had been suffering for some time from a slow and wasting disease, died at the end of September, B.C. 429. With him vanished the superior statesmanlike spirit and breadth of view that alone could carry out a plan of campaign covering the whole of a constantly widening theatre of operations, while turning to account diplomatically all new incidents.

Unfortunately, there were in Athens no longer a permanent council of state with fixed traditions, no strong magistracy—except in the finance department—with sure political training and definite routine, and no popular aristocracy. Thus it was inevitable that there should be a fierce struggle among those who were ambitious to succeed Pericles. New importance was now won by the moderate aristocracy, which passed almost without visible line of demarcation into the numerous group of prudent democrats, the latter including most of the elder and wealthy citizens. These parties furnished a very noticeable array of talents for the public service, especially for the army. To the former group belonged Thucydides (Fig. 152; cf. Fig. 151), son of Olorus, the historian of this war, himself a nobleman. Through his father he was a descendant (probably great-grandson) of the Thracian prince Olorus, who had about 515 B.C. married his daughter, Hegesipyle,

to Miltiades, afterwards victor of Marathon. Thucydides's mother, Hegesipyle, through whom he was a blood-relative of the house of Cimon, was probably a granddaughter of the victor of Marathon. This young statesman, who was born about 460 B.C., had come by inheritance or marriage into the possession of important gold-mines at Scapte Hyle on Mt. Pangaeum, and his Thracian connection brought him into relations with the court of the Odrysian king Sitalces.

The real leader, however, of those elements was a general of noble birth and great wealth, Nicias, son of Niceratus, who reminds one, in some respects, of Cimon. He looked upon the present war as a great misfortune, and considered an honorable peace with Sparta possible, without hoping or wishing for the complete overthrow of the hostile



FIG. 151. — Herodotus.
(After Visconti.)



FIG. 152. — Thucydides.
(After Visconti.)

power. Though he did his full duty in the field and on the fleet, he could not be compared as a general with Cimon, whose vigor and daring were foreign to Nicias. Though he was repeatedly successful in war, and long enjoyed the confidence of the commons, this was owing, in addition to his undeniable military talent, mainly to the fact that he proceeded always with extreme caution, and prepared for his undertakings as surely and methodically as possible. As statesman, however, he won few laurels. He was loyal to the constitution, honorable, conscientious, and in office painfully diligent; but, though in critical moments true to his convictions, he lacked charm of speech, and, with his slowness and want of self-confidence, had neither tact nor inclination to deal with the people. His stubborn orthodoxy, his bigoted, superstitious nature, which caused him to be much influenced by the priests, was a bond between him and the people; but his political influence rested mainly

on his riches, of which he made a very generous use, and with which, moreover, he was glad to buy himself free from the attacks of demagogues. At all events, he was, with his passivity and his lack of ideas, only a weak support of his party, and little qualified to cope with the radicals, the demagogues from the ranks of the business men, who now for many years ruled the popular assembly.

Among the latter, Cleon attained to very great influence. It is not easy to give a correct historical judgment of this person. It is not fair to adopt as historical all the accusations against him which can be found in the comedies of his enemy, Aristophanes; nor can his image be sketched after the model of the men of the French Revolution or of social-democratic demagogues. The true analogy for Cleon is found in the history of the popular leaders, who in the Middle Ages, at the head of the democracy in the cities of Italy, Germany, and Flanders, waged fierce war upon the patricians. Cleon is the type of the passion and the ambition with which, after Pericles's death, the more talented men of the Athenian middle-class entered the lists against patrician statesmen and generals. He united with shrewd Attic sense, supported by the voice of a lion, very considerable oratorical talent, which had been trained in the *Ecclesia*, in the *Boulé*, and in the *dicasteries*, until he had come to be universally feared for his sharp and ready tongue. His strength lay in the fact that he perfectly understood and shared the feelings, temper, interests, and prejudices of the commons, and knew how to give the most reckless expression to these, preserving at the same time a defiant independence, and, when occasion required, not hesitating to say hard things even to the people. No defender of Cleon will ever be able to make him agreeable; that is not a characteristic of politicians in opposition who seek to win power by means of ceaseless petty warfare. He cannot, however, be reproached because he strove with increasing success to attain to power. The misfortune for Athens was that the apprentice years of these new middle-class politicians fell just in a time of the greatest danger, and that there was no longer any superior political leadership opposed to them. It was Cleon's personal misfortune, that, with all his talent and genuine patriotism, he had a very limited horizon, and narrowly followed only two political principles. On the one side he was governed by an extinguishable mistrust of the aristocratic elements in Athens, which he often opposed, it is true, with good reason, but often, also, with blind hate. The result was, that he brought into the *Heliaea*, the *Boulé*, the *Ecclesia*, a tone of vulgar spite and partisan extravagance. He saw

everywhere only the evil, and recognized, in everything evil that he saw, only malicious and tricky hostility to the people. Thus party life at Athens gradually won a character, hitherto unknown, of irritation and of virulence. Cleon's opponents did not fall behind him; especially one of the most gifted young men of this time, the celebrated comic poet Aristophanes, himself from the deme Cydathenaeum (born about 444, died 380 B.C.), and at that time in constant intercourse with the noble youth of Athens (Fig. 150). During a number of years he attacked in several of his comedies the detested 'tanner' with a combination of rancorous wit and biting satire, the like of which is hard to find in the literature of any time. On the other side, Cleon was the personification of the popular hate against Sparta. According to his view, the war ought not to be ended without the complete defeat of

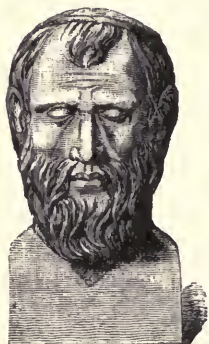

FIG. 153. — Aristophanes.

the Peloponnesians. He was rightly opposed to any premature peace, and in this respect might very well have found support from good generals who did not belong to his party. But Cleon was not a character to win support from his political opponents; he was far too ready to believe them traitors, and to express this belief. In this direction, indeed, he was not without grounds. The peace-party at Athens consisted, at least in part, of oligarchic elements, which would have been quite ready to make very dangerous concessions to the Spartans. But it was ruinous for him and for Athens that this upstart 'of the people,' in whom excellent traits are intermingled with foolish

and bad ones, lacked entirely the political training, — rarely to be supplied by natural endowment, — as well as tradition and experience, necessary to the management of foreign relations. With the commons Cleon acquired permanent influence, especially by carrying through (probably in B.C. 425) a measure which increased the pay of the dicasts to three obols. The annual expense for the pay of the dicasts is reckoned at about 150 talents. In what position Cleon carried through this and other financial measures is a matter of dispute. According to the old view, he was, until he became strategus, only an opposition orator without any other office than the annual one of member of the Boulé; but lately the view is becoming more prevalent, though not without contradiction, that Cleon held for a time a high financial office. In the foreign policy Cleon's influence becomes very manifest in 427 B.C., at which time he first appears as a member of the Boulé.

The discord of the various parties on the great theatre of war was perceptible as early as B.C. 429. King Perdiccas had, during this year, supported the attacks of the enemies of Athens on the Acarnanians, as well as the Bottiaean and the Greeks of Chalcidice in their successful struggles with the Athenians at Spartolus (June, 429). But Sitalces, king of the Odrisian Thracians, who had made an alliance with Athens in 431, now began operations, together with an Athenian army, against Perdiccas and the other enemies of Athens on Chalcidice. He collected at Doberus, on the Macedonian frontier, an army of 100,000 foot and 50,000 horse, with which he advanced early in November as far as the Axios. But the Athenians now became anxious themselves at the too great force of their ally, and determined to get rid of this dangerous help. Sitalces was induced to give up the expedition after he had been thirty days on Macedonian soil. In 428 the interests of the hostile parties concentrated especially on two points. The Athenians were greatly startled by the news that the greatest part of the island of Lesbos, which had been considered especially loyal and in federal affairs had nothing to complain of, had revolted. The timocratic government of Mytilene, the so-called 'thousand,' had already, before the outbreak of the war, entered into secret relations with Sparta, which now through the influence of their kinsmen, the knights of Thebes, took on a more earnest character. Much against the will of their own commons, they openly broke with Athens when Archidamus invaded Attica for the third time. The Spartans took the island into their alliance, but allowed their measures of assistance to be completely outstripped by the energy of the Athenians. To meet this new danger the latter called into service all their financial resources, even imposing, in the already somewhat depleted state of the treasury, a property tax, or *eisphora*, of 2000 talents, and increasing the burden of the allies in like manner. The Attic troops, under Paches, at the beginning of winter blockaded Mytilene as closely as possible. At the same time the Athenians were concerned about the fate of the faithful citizens of Plataea, who, after removing their women and children to Athens, had now, to the number of 400, defended their walls since 429 with the greatest obstinacy and bravery against the Boeotians and Spartans, but were gradually reduced to great straits. The trying year 427 B.C., brought the crisis at both these points. When at last the starvation of the beleaguered Mytileneans caused the nobility to arm the commons with a view to making a vigorous sally, the latter, as soon as they got the weapons into their hands, forced the patricians to give up the city to Paches. The captive

aristocrats were sent to Athens, where their fate was to be decided by the people. The latter were fearfully embittered; and the now apparent insecurity of the Attic alliance, besides the great costs of the Lesbian war, incited them to a cruel punishment of the conquered Mytileneans. On a vote, in spite of all the efforts of the moderates, the horrible decree was passed, with Cleon's energetic help, that all men capable of bearing arms, 6000 in number, should be killed, and the women and children sold as slaves. Already the ship was under way which was to bring to Paches this fateful decree, when public feeling began to change and milder sentiments to prevail. It seemed a great piece of folly to exterminate the commons of Mytilene, which had really caused the surrender of the city. The change of sentiment became so strong that the Athenian authorities, contrary to traditional usage, summoned a new assembly of the people on the next day to reconsider their action. This time Cleon exerted the whole power of his eloquence, though in vain, to induce the Athenians to stand by their bloody decision. A second boat was despatched to countermand the first decree, and by almost superhuman effort arrived in time to save the doomed city. But the sentence was still very severe. Mytilene lost her walls and fleet; the lands of the rebellious part of the population were divided into several thousand lots, which remained in the hands of the Lesbians, but for which these paid an annual rent to 2700 Athenian citizens. The captive aristocrats, 1000 in number, were executed. The answer of the enemy to this deed of blood was given not long after at Plataea (mid-summer, 427). The small remnant of the garrison was finally compelled to surrender. The ancient glory of this town did not save it. After the forms of a military trial, the brave warriors were condemned and butchered, the city destroyed by the Thebans, and its territory added to that of Thebes.

This mode of warfare found its parallel in the party struggles which took place the same year at Corcyra. Here a strong aristocratic party, which had been won over by Corinth, attempted, not long after the fall of Mytilene, to overthrow the democracy then in power, and to bring over the island to the Peloponnesians. Sanguinary conflicts took place between the two parties; but the arrival of the Athenian Nicostratus, with twelve ships and five hundred Messenians from Naupactus, decided the victory of the democracy and the formal entrance of Corcyra into the Athenian league. But when, soon after, a Peloponnesian fleet won a victory over the Coreyreans, nothing but the bravery of Nicostratus, the irresolution of the Peloponnesians, and

finally the arrival of sixty Attic ships under Eurymedon, prevented the fall of Coreyra. The retreat of the Peloponnesians gave to the democrats opportunity, with the help of many freedmen and debtors, to fall upon their opponents, and hold a carnival of murder for seven days. But five hundred aristocrats escaped, cut off the supplies for the city from the Epirote coast, and finally fortified themselves on Mt. Istone on Coreyra, in order to damage the democrats as much as possible from this point. Similar horrors ruined many Greek cities as the war went on, and the more so in proportion as everywhere the contrast between aristocrat or oligarch and democrat coincided with that between Spartan and Athenian, and gradually began to assume the shape of opposition between 'rich' and 'poor.'

In the year 427, also, the Ionian and Dorian cities in Sicily in their feuds began to be involved with the great race war of the mother-country. Gelon of Syracuse was succeeded in the regal power in B.C. 477 by his brother Hiero, celebrated for his wealth, his brilliant court, and his patronage of the poets Aeschylus, Simonides, and Pindar, and the philosopher Epicharmus. In 474 his fleet inflicted on the Etruscans, then lords of the Tyrrhenian Sea, a defeat from which their power never recovered. Agrigentum came under his sway in 472. But after Hiero's death, in 467, the cruel reign of his brother Thrasybulus led to a revolt in the following year, by which he was driven out of Sicily. After this a long period of internal confusion and aimless strife ensued among the Sicilian cities, which at last (from about 432) resulted in something very like a race conflict between most of the Dorian cities, headed by Syracuse on the one hand, and on the other the Ionian cities Leontini, Naxos, Catana, together with the Dorian Camarina and Rhegium in Italy. In the summer of 427 B.C. the Leontinians were so hard pressed that they appealed to Athens for help. The brilliant eloquence of their ambassador, the philosopher Gorgias, induced the Athenians to interfere directly in the Siceliote quarrels, — an extension of the theatre of war which divided the strength of Athens, and weakened her defensive resources at home, at an unfortunate moment. The Athenians were at least wise in this respect, that the force sent to Sicily in 427 was not large. This enterprise, carried on from Rhegium as base, produced no considerable result. When finally by the spring of 424 the Athenian fleet at Rhegium had been increased to sixty ships, the Siceliotes became anxious, especially in view of the great advantages just then won by the Athenians in the Peloponnese. But the shrewd Syracusan statesman, Hermocrates, leader of the moderate

aristocratic party then dominant in his city, succeeded in bringing the Siceliotes in congress at Gela to an agreement among themselves, and to the great chagrin of the Athenian demagogues, the fleet was politely dismissed.

But the transfer of a part of the Athenian forces to the Ionian Sea had resulted in very considerable advantages in the Peloponnese, and to a very important extension of the old Periclean plan of campaign. During the year 426, Spartans and Athenians had only experimented, as it were, in Greece. The former, at the wish of the people of Doris and of the Malian Trachis, fortified Heraclea, about five miles from the western entrance to Thermopylae, a point of great strategical importance. On the other hand, the energetic and able Athenian general, Demosthenes, sought, in agreement with the Messenians of Naupactus, to bring under Attic supremacy the rude tribes of Aetolia, who dwelt still in Homeric simplicity in the mountain villages between the Ache-loüs and the sources of the Sperchius. His underestimation of the difficulties of this campaign, and his undue haste, resulted in a severe defeat for the Athenians, and carried the Aetolians, for the present, over to the side of the Peloponnesians. But Demosthenes soon won great reputation by several successful feats of arms. A strong Peloponnesian army, under the Spartan Eurylochus, went, toward the end of the year, to the aid of the Ambraciotes, who were about to engage in war with the Acarnanians. Against this superior force, Demosthenes placed himself at the head of the Acarnanians, Messenians, and a small body of Athenians, and won, near Olpe, a great victory, which was followed, after the retreat of the Peloponnesians, by a new and great blow against the militia of Ambracia. The Athenians paid little attention to the predatory incursion of King Agis II. into Attica in 425 B.C. They sent in the spring of that year the generals Eurymedon and Sophocles, with about forty ships, to the Ionian Sea, who, after relieving the Corcyreans from the pressure of the aristocrats, were to cross over to Sicily. With them went Demosthenes, who had been permitted, at his own request, to accompany the fleet, in order to occupy suitable points on the coasts of the Peloponnese. It was his happy idea, suggested probably by the Messenians, to garrison the excellent, but then completely deserted, harbor of Pylos, on the Messenian coast. With some difficulty he persuaded the generals to carry out his plan. A fortification was erected opposite the northern entrance of the bay, before which lies the little wood-covered island of Sphacteria, and this fortress was guarded by five ships and two hundred hoplites. The

Athenian fleet sailed on. But the news of Demosthenes's descent in Messenia caused the Spartans, who comprehended instantly the consequences of this move, to take very energetic steps. King Agis left Attica without delay; and a Peloponnesian fleet which had been sent against Coreyra was recalled, and led against Pylos. About the position of Demosthenes, who had been able, in the last moment, to despatch two boats to Eurymedon, a bitter conflict now raged. There was little danger to the Athenians from the land side. But on the sea side the Peloponnesians occupied first the island of Sphacteria, and then sought to take the fort by way of the bay. But the Athenian fleet now returned, fifty sail strong, forced its way into the bay of Pylos, defeated the Peloponnesians, and compelled them to draw their ships up on shore. Thus several hundred picked men of the Peloponnesians were cut off from all help, as well as supplies, on the island of Sphacteria.

Under these circumstances, the Spartans lost courage. They began to think of peace, concluded an armistice with the Athenian generals on such terms as they could get, and sent, without delay, an embassy to Athens, in order to effect a treaty of peace. It was a great moment for the Athenians; but, unfortunately, they had no statesman who knew how to utilize the opportunity. Cleon made himself spokesman of the people, which was intoxicated with success, and caused the latter to demand that the warriors shut up on Sphacteria should be brought as captives to Athens, and that all the places in the Peloponnese and Megara, which they had lost by the peace of B.C. 445, should be restored to Athens. The latter would then restore the captives to Sparta, and enter into negotiations about an armistice. When the ambassadors, in view of these extraordinary demands, proposed that the Athenians should appoint a commission, with whom they could discuss each point, Cleon attacked them with his usual bluntness. In his distrust of Sparta and of the moderate elements in Athens, he feared, however proper the proposal, the negotiations of a commission. He would hardly be able to control it himself, and was anxious lest Nicias and his friends might grant the Spartans too favorable conditions. Therefore, he demanded that all negotiations be conducted before the assembly. This the ambassadors could not possibly agree to; and so the attempt at peace failed, and the conflicts at Pylos and Sphacteria were renewed. As the blockade of Sphacteria was protracted beyond expectation, and it was feared at Athens that on the approach of winter the fleet would be obliged to withdraw without success, Cleon

found it hard to maintain himself before the people and his opponents. When he once expressed himself in a very dogmatic and boastful manner about affairs at Pylos, he was forced to undertake himself the chief command. Whether he was really surprised, or whether he had consciously acted with great demagogical shrewdness, he now put on a bold face, and actually promised within twenty days either to kill the Spartans on Sphacteria, or to bring them captive to Athens. While his enemies at Athens were indulging the hope of seeing him ruined, Cleon went to work. He took with him some hoplites from Lemnos and Imbros that were at Athens, some Thracian light-armed troops, and four hundred bowmen. Demosthenes, with whom he probably had already an understanding, and whom he knew to have been long anxious to strike a bold blow at Sphacteria, was appointed as assistant commander. Thus Cleon was able to make good his promise. A well-laid plan of Demosthenes, which was finally supported by Cleon's fresh troops, succeeded completely. Making a good disposition of his superior force of light troops, he stormed the island with his land and naval forces, and after a long combat forced the enemy to surrender, 292 in number, including 120 Spartans.

It was a heavy blow for Sparta. With the memory of Leonidas no one had heretofore thought the surrender of Spartan troops even possible. Cleon's influence now rose to the zenith, so that the Athenians rejected the Spartans' renewed proposals of peace, which clearly did not go far enough for them. They were later bitterly to repent this action. At this time their prospects were extremely favorable. The captive Spartans served as hostages to secure Attica from new devastations. Pylos was garrisoned with Messenians from Naupactus, who from this fortress kept the country insecure, and incited the Helots to revolt. Quantities of money were raised in order to push the war with energy; this time by ruthless treatment of the allies, whose tribute had been so increased, on Cleon's motion, that the sum total was something over 1200 talents. But in Corcyra party rage was at this time enacting the most horrible scenes. Eurymedon had, after the fall of Sphacteria, again turned his attention to Corcyra, and forced the aristocrats on Istone to surrender, but unjustifiably delivered them up to the commons of Corcyra, who murdered three hundred of them in cold blood. For the Spartans and their friends no end of their misfortunes was in prospect. Nicias completed on the east side of the Peloponnese the system which Demosthenes had so successfully begun on the west side. He conquered now the volcanic peninsula of Methana, which

furnished a strong base of operations for attacks on the territories of Epidaurus and Troezen. And when, in the spring of 424, he occupied also the island of Cythera, and on his return dragged many Aeginetans, captured in Thyrea, to Athens to be cruelly put to death, the Spartans were in despair.

The fortune of war, however, now began to turn against Athens. On Demosthenes's suggestion, an attempt was made to conquer Boeotia and Megaris. The attack on Megara failed at the last moment, through the quickness and skill of the Spartan Brasidas; only Nisaea remained in the hands of the Athenians. The plan of a triple advance against Boeotia was betrayed to the Boeotarchs, and completely baffled (October, 424). The defeat of Hippocrates (nephew of Pericles) at Delium was an especially severe blow. He marched, with 7000 hoplites and more than 20,000 light-armed troops, into the territory of Tanagra, occupied and fortified the important strategical point of Delium, and then sent most of the light-armed troops home. He was, however, forced by the Boeotarch Pagondas to accept a battle, in which the Athenians sustained a severe defeat from the superior force of the enemy. Meanwhile, in the northernmost part of the great theatre of war, things had taken a turn far more unfavorable still for Athens. Since the beginning of 424 B.C. the Greeks of Chalcidice, who were hostile to Athens, had, supported by Perdiccas, urged the Spartans to send them a Peloponnesian army with a resolute leader, to be maintained at their expense. In the depression of the Spartans, the boldest general and shrewdest statesman of the time among them, Brasidas, who had already been proved in many ways, took the matter in a measure into his own hands. He was convinced that Sparta could be relieved from her difficult position if the war should be transferred to a new quarter, where at the same time the roots of Athenian power could be threatened. With a number of Helots and 1700 hoplites, whom, by means of remittances received from the Chalcidians, he enlisted in the north of the Peloponnese, he reached by forced marches, near the end of the summer 424, the Macedonian city of Dium. The Athenians underestimated the new danger, and thought it unadvisable to make any great effort in the rough and late season of the year. They accordingly left to their own resources their generals, Eucles in Amphipolis, and Thucydides, son of Olorus, who was near Thasos with seven ships of war. The latter's personal authority in these regions, and his influence at the Odrysian court, seemed to offer sufficient security against the critical state of feeling in Chalcidice. It was not yet known that at that very

time King Sitalces had, after being defeated in an expedition against the Triballi, lost his own life, and that his nephew (and perhaps murderer), Seuthes, an enemy of the Athenians, had seized the crown. The first expedition of Brasidas was with Perdicas against the Lyncestian prince Arrhabaeus. But he soon adjusted the quarrel by a treaty, and gave his attention to the Hellenic southern coast of Macedonia. Everywhere he displayed a faculty of eloquence and diplomacy unusual among the Spartans of that time. A man of genuine knightly ways, displaying a mildness and forbearance unknown in war at that time, the programme of 'true freedom,' which the Spartans were to restore to the Greeks oppressed by Athens, had in his mouth such a magic effect that even the commons did not resist. Soon Acanthus went over to his side, followed by Stagira and Argilus. Not long after the battle of Delium, Brasidas made a bold attempt on Amphipolis. Whether and how far Eucles, who commanded at Amphipolis, and the general, Thucydides, can be reproached with negligence is, from our present knowledge, impossible to decide. At any rate, on a winter's night Brasidas surprised the city, and Thucydides came a few hours too late to save for the Athenians the pearl of the garland of allied cities; he was able only to maintain the port of Eïon. In the anger of the Athenians over the heavy loss, Thucydides was accused of high treason, by Cleon, it is said, on the ground that he had injured the public interests, whether by negligence or conscious treachery, and was (as it seems) found 'guilty.' At any rate, he did not then return to Athens, but spent twenty years in banishment, which he employed in collecting materials for his immortal history of the Peloponnesian war. Under the double effect of the news from Delium and from Amphipolis, the revolt in the north became general; the cities on the peninsulas of Acte (except Sane and Dium) and Sithone all went over to Brasidas, and at the beginning of the year 423 the star of Athens was decidedly on the decline. (For the dependencies of Athens and Sparta, see PLATE XVIII.)

Still, oligarchic jealousy at Sparta saw in the conqueror of Amphipolis only a successful adventurer. Whoever did not envy him yet considered his success only as means to secure the release of the captives from Sphacteria. Besides, the king, Plistoanax, whose recall from exile had been brought about through the influence of the Delphic priesthood, was working, with Delphic help, for the restoration of peace, which might secure his position, and which he hoped to inaugurate joyfully by bringing back the captives. In Athens similar senti-



W. J. ...
...





Dependencies of Athens and Sparta.



ments prevailed. The peace-party of the older and more moderate, the rich and conservative citizens, won the upper hand; in March, B.C. 423, a truce was concluded for one year, each side to retain for the present its possessions. This was looked upon as the preparation for a definitive peace, but it did not come to that immediately. Before the news of the truce reached Chalcidice, Brasidas had induced the cities of Scione and Mende on Pallene to revolt from Athens. The Athenians immediately attacked these cities with a strong force, while Brasidas quarrelled with Perdicas, and saw in consequence the king become reconciled with the Athenians, and the march of Peloponnesian troops through Thessaly made impossible. Mende fell into the hands of the Athenians, who then closely besieged Scione. When the truce ended, the Athenian war-party, Cleon at their head, carried through a proposal to undertake another great expedition to Macedonia, in order to restore here the honor of Athenian arms and interests and to take revenge for the fall of Amphipolis. But unfortunately it was Cleon—since the affair at Pylos a member of the college of strategi—that sailed with 1200 hoplites, 300 horsemen, many allies, and 30 ships of war, probably about the first of August, 422, to Chalcidice, and this time without so excellent an assistant as Demosthenes. A great part of his troops wished him no success, and their confidence in him was small. Still, he met with some success at first. But an attack could not be made on Amphipolis until the expected auxiliaries from Perdicas, and the friendly Odomantes should arrive; and Cleon had not influence enough over his troops to keep them together inactive for any length of time. He allowed himself, therefore, to be led into making a great reconnoitring expedition against Amphipolis. On his way back he was attacked at a very critical moment by Brasidas, and forced to accept a fight, which he was incompetent to direct. Brasidas himself fell in the beginning of the battle; but Cleon was killed in flight, and the Athenians were driven back to Eïon, with a loss of 600 men (autumn, B.C. 422).

Thus the two chief representatives of the war-parties in Athens and Sparta disappeared from the stage. Nicias (from whom the peace afterwards took its name) and Plistoanax found no longer any difficulty in inaugurating negotiations for peace. Everybody wished to see an end put to the murder, party rage, and disorder in all departments of civil life. Not all Greek states, indeed, were inclined to adopt the conditions agreed upon by Athens and Sparta; for the main clause, that each party should give up what it had conquered during

the war, was imperfectly carried out, and roused great dissatisfaction at various points. Finally it was agreed that peace should be concluded for fifty years, and new differences should be peacefully settled. Amphipolis and the Chalcidian cities were to revert to Athens as tributary, but autonomous, cities. The captives were to be restored on both sides. Peace was concluded by the two leading powers toward the end of March, 421, and in April solemnly ratified by oath. But Thebes, though she was permitted to hold Plataea, did not recognize the treaty, because she was unwilling to give up the recently taken Attic border-fortress of Panactum; nor did Corinth, because she would not renounce her claim to Anactorium. These two cities, however, also presently ceased hostilities, though their vexation was so bitter that their connection with Sparta was in effect broken. It did not lessen their mistrust that the treaty of peace contained the final clause, that Athens and Sparta arrogated to themselves the right of supplementing the treaty on the basis of a mutual understanding.

Unfortunately this peace bore in itself no assurance of permanence, since there had been no decision of any question, either as to possession or principle, and no real reconciliation had been effected. Besides, many details of the treaty offered to the war-party in Sparta, as well as in Athens, the means of stirring up fresh trouble. In Athens the war-party—the younger men and the most unsettled elements of the city, and still more of the Piræus—had found new leaders. The real heir of Cleon was one of his former associates, Hyperbolus, owner of a large lamp-factory, a man inferior to him in character and ability, and of even narrower political horizon, who sought now to take the place of leader of the ‘people’s party.’ He, too, was attacked with concentrated wrath and bitter scorn by the comic poets, especially by Eupolis, Hermippus, and Plato.¹ Just then Alcibiades (Fig. 154), one of the most brilliant young knights of this period, placed himself at the head of the war-party. A section of the ancient nobility, but of democratic leanings, a near relative of Pericles, and brought up in his house (born in 451 B.C.), he was, with his rich and brilliant gifts, a striking figure. Great personal beauty, boldness, defiant self-confidence, which mocked at all discipline, long characterized this spoiled favorite of the people and of the ladies. He was highly cultured, but savage and whimsical, even tyrannical, as a youth a leader among the young and dissolute men of high birth. At the same time, he was capable of the noblest impulses, so that it was possible for him to en-

¹ Not the philosopher.

joy for some time an intimate friendship with a man like Socrates. Such was he in the early days of the Peloponnesian war. Men who observed his valor as a soldier, his political, and especially his diplomatic talent, fondly hoped that when once his youthful folly had spent itself, as in the case of Themistocles and Cimon, he would develop into a genuine statesman. But his arrogance, his frivolity, and his unscrupulousness prevented that. Gradually in him ambition developed into an all-controlling passion, in the service of which he displayed as occasion required, not only a winning amiability, but an astonishing facility in adapting himself to the habits and pet ideas of the different peoples with whom he came in contact. Finally this trait, which was directed by selfishness, became hurtful to all Greece, while the lack of all moral principle proved fatal to himself, causing him to act with perfect recklessness toward not only individuals, but even whole parties.



FIG. 154. — Alcibiades. (After Visconti.)

Alcibiades had been, as his origin and station required, an enemy of Cleon until the conclusion of the peace with Sparta; but now he was jealous of the great influence and reputation which Nicias had just won. Thus his conduct was determined for the moment by selfish feelings. Hitherto eager to renew, by many services and attentions shown to the captives of Sphaacteria, the friendly relation existing in the time of his grandfather between his house and Sparta, he found, when the Spartans overlooked him in the negotiations for peace, and gave their confidence to Nicias, that he could depend far better on the warlike popular party. It was with joy that these saw a young man of an ancient noble family, handsome and brave as Achilles, an elegant and charming orator, full of new ideas, assume the leadership. It still had a magic effect on the common man when a Eupatrid shared the best as well as the most dangerous tendencies of the people, and knew how to express them in elegant form. Alcibiades soon had opportunity to prove himself an opponent of Nicias and of the Spartans, not less dangerous than unscrupulous. The refusal of the Boeotians, Megarians, and Corinthians formally to ratify the new peace, led the Spartans to enter into close relations with the Athenian government, and to make with it an alliance for fifty years, which pledged both states to mutual

support against every hostile attack, and Athens to render aid to Sparta in case of an insurrection of the Helots. The exchange of prisoners, even of those from Sphacteria, followed. But an alliance was now formed between several states hitherto allied with Sparta, which complained of disregard of their interests. The ever-restless Corinth made an alliance with Argos, which during the thirty years of peace that it had enjoyed had thoroughly reorganized its army. Elis and Mantinea likewise joined Corinth, to which further the Chalcidian cities, which had been remanded by the treaty of peace to a sort of half-dependence on Athens, attached themselves, — the latter frightened by the fact that just then Scione had been taken by the Athenians, who, after butchering its inhabitants, supplied their place with homeless Plataeans. Meanwhile considerable misunderstandings arose between Athens and Sparta. As the Boeotians did not vacate Panactum, and the Spartans were not able to restore reluctant Amphipolis to the Athenians, the latter refused to surrender Pylos; and soon the ambiguous policy of the Spartans undermined the party represented by Nicias at Athens, and opened the way for the radical democracy. The Spartan elections in the autumn of B.C. 421 gave a majority to the war-party in the council of the ephors, who concluded at the beginning of 420 an alliance with the Boeotians. This act was rightly received with disapproval at Athens, and did not appear in a better light when the Spartans declared that this had been done only in order that they might finally restore to the Athenians Panactum and those captives that were still retained in Boeotia. As the Thebans had levelled meanwhile the fortifications of Panactum, no one thought any longer of giving up Pylos. This disagreement between the two leading powers enabled Alcibiades to come to the front. At his suggestion ambassadors from the democracy of Argos, as well as from Elis and Mantinea, appeared in the spring of 420 at Athens, to form an alliance. The effort of the Spartans to prevent this, and on any proper terms to restore the good understanding, was frustrated by the wiles of Alcibiades. He persuaded their ambassadors to commit the folly of representing themselves before the Ecclesia, on the second day of the negotiations, in contradiction to what they had stated on the first day, as not having plenipotentiary power, and promised them in return to effect the evacuation of Pylos. He then took advantage of the contradiction of which he himself had been the cause to attack them most bitterly before the popular assembly, and to emphasize the impossibility of an honorable treaty with people who spoke differently every day. Athens now formed an alliance with

Argos, Mantinea, and Elis. Alcibiades, who in the new elections supplanted Nicias, and received his place at the head of the college of strategi, undertook, early in 419, an expedition to the Peloponnese. His force, however, was small; for the Athenians needed a part of their troops to fight the Chalcidian cities and Amphipolis. On the other hand, the peace-party was much too strong to allow so soon again open war against Sparta. Since similar conflicting sentiments prevailed at Sparta; the contest between the two leading powers was carried on for several years only indirectly, as it were. Alcibiades effected in 419, in the Peloponnese, only the alliance of the old Achaean town Patrae with Athens, which with Naupactus made it possible to exclude the Corinthians from the gulf of that name. The next year (418) the peace-party prevented the election of Alcibiades; and the Spartans, in order to relieve Epidaurus, which was threatened by Argos, sent in the summer a large army of Peloponnesians and other allies, under Agis, against Argos. The armistice which Agis, for reasons not known, granted under the walls of the city to the old enemy, caused the bitterest dissatisfaction on both sides. And when, some time later, 1000 hoplites and 300 horsemen from Athens arrived at Argos, led by Laches and Nicostratus, and accompanied by Alcibiades as political agent, and when Argives, Mantineans, and Eleans joined with the Athenians in a renewal of the war in Arcadia, Agis had to submit to the presence of a war-council of ten men, who from this time were kept at the king's side to watch his actions. The hesitation of the Athenians during this year seems to have been caused by internal factions. It was probably now that the parties of Nicias and Alcibiades tried their strength by an appeal to ostracism. The result was surprising: the leaders united in directing the blow against the demagogue Hyperbolus, who was an abomination to the peace-party, as well as an annoyance to Alcibiades. On the new theatre of war, just after the Eleans had gone home, King Agis appeared at Tegea with five-sixths of the whole Laconian military force, won over the Arcadian contingents, and gained under the walls of Mantinea a great victory. This battle restored the glory of Spartan arms in the Peloponnese. In Argos the democracy collapsed; the oligarchy accepted, in the winter of 418-417, the peace proposals of Sparta, broke off the relations with Athens, concluded an alliance with Sparta, to which also Chalcidice and Macedonia became parties, and by a revolution overthrew, toward the end of the winter of 417, the democratic constitution. This turn in affairs seemed to be a great blow to the policy of Alcibiades; but, as his luck would have it, the arrogance of

the oligarchy in Argos called forth a new democratic revolution within eight months. Athens interfered in favor of the democrats. Alcibiades himself went to Argos, had the road to the coast — a distance of nearly three miles — protected by walls, and renewed the former alliance.

The subjugation and cruel punishment in B.C. 416 by the Athenians of the Dorian island of Melos, which, hitherto neutral but friendly to the Spartans, had refused to join the Athenian alliance, showed very clearly how war was developing a strain of savagery. But the wails of the Melians died away amid the noise of the mighty preparations of the Athenians for their unfortunate expedition to Sicily. The peace of Gela had not led to permanent quiet in that island. Hostilities had again broken out between Syracuse and Selinus on the one hand, and Leontini and Egesta on the other; and the overwhelming superiority of Syracuse threatened to bring the whole island under Dorian rule. Late in the summer of 416 the Egesteans sent ambassadors to Athens, to seek help. The thought of a great military expedition to Sicily found a dangerous response with a considerable part of the Athenians, who were enticed and intoxicated by the charm of distance, having, as they did, a very indistinct idea of the difficulties of a Sicilian campaign, and unfortunately Alcibiades was the most eloquent representative of this idea. However plausible the arguments in favor of it, the affair was criminally foolish. Extraordinary difficulties opposed the success of an expedition for conquest beyond the Ionian Sea. It was impossible, even in case of an initial success, from so small and distant a basis as Attica, to maintain such a conquest against Sparta and Corinth, the Etruscans, and the Carthaginians. Finally it was monstrous folly, with the Peloponnesians on their flank and in the rear, to strain to the utmost the already much exhausted military and financial resources of the Athenian empire, by plunging into a new conflict of incalculable dimensions. All this, it seems, must have been apparent to Alcibiades. But he was influenced by unscrupulous selfishness; he saw that if he brought this war to a successful issue, his supremacy would be undisputed in Athens and over a great part of Greece. The still large number of prudent men in Athens could do nothing against the enthusiasm of the public for this war. The ambassadors whom the Athenians sent to Egesta allowed themselves to be only too willingly deceived by the cunning Siceliotes, and brought back the most favorable reports of the resources of the Egesteans. In vain did Nicias, who much against his will was appointed with Alcibiades as one of the leaders of an expedition which he could only contemplate with horror, use every means to cause a repeal

of the declaration of war. The tragic irony of his fate willed that all the opposition of this prudent soldier only resulted in the granting of still greater forces than even Alcibiades demanded. When the fatal decree had been irrevocably adopted by sessions of the popular assembly, on March 19 and 24, 415 B.C., preparations began to be made with energy.

Before the fleet set sail, however, the greatest consternation was caused by the discovery, on the morning of May 11, 415, that the numerous marble statues of Hermes, in Athens, were found, with few exceptions, to be mutilated or destroyed. The religious feelings of the Athenian people were most deeply injured; mortal anxiety at the wanton insult offered the gods, and terror of their anger, seized the populace. It seemed, for the moment, as if in the horror aroused the Sicilian expedition would be given up. If that had really happened, the malicious intriguers, who had committed under cover of darkness this wanton impiety, would have unintentionally deserved well of the city. But on the contrary, that night was the beginning of a chain of political moves which soon threatened the very existence of the power of democratic Athens. The mutilation of the Hermae was probably no accidental result of the drunken wantonness of a troop of young debauchees. It must rather be considered the underhand work of a group of embittered antagonists of Alcibiades, who had made very many enemies among the demagogues of the lower class, still more among the young oligarchs. Many such young men had in their clubs come to be uncompromising partisans, knowing no higher interest than that of clique, before which even the welfare of the country had to give away. Among these men were the most violent opponents of Alcibiades, who had nothing more to fear than the power which a victorious Sicilian campaign would give to this renegade from their own class. It is probable, therefore, that the mutilation of the Hermae originated with these, the prime object being to deter the Athenians from the expedition to Sicily.

The Boulé, in common with the Ecclesia, sought to reach the impiety by a criminal investigation. Demagogues, like Pisander, Charicles, and others, who several years afterwards threw off the mask as revolutionary leaders, caused rewards to be offered for informers, and finally, with the aid of ultra-democrats and fanatical priests, secured an extension of investigation so as to cover all impieties lately committed in Athens. Thus it became possible to turn the rage of the people against Alcibiades, whose morals were by no means unassailable. Informations of every kind and condemnations followed thick and fast, in which not a

few oligarchic leaders came to grief. The democrat Androcles now formally accused Alcibiades before the Boulé with forming a club whose designs were hostile to the constitution, and of celebrating with club-mates a parody of the Eleusinian mysteries. In the meeting of the popular assembly called to take cognizance of the matter, Alcibiades, depending on the sentiment of the troops and seamen, and of the friendly Peloponnesians, who through his influence were present as mercenaries, emphatically demanded that the case should be tried at once before the departure of the fleet. His enemies, however, cunningly induced the commons, under the false idea that they were doing Alcibiades a favor, to postpone the trial until after his return from the Sicilian expedition. The fleet put to sea, accordingly, early in July, 415. Immediately afterwards the investigations were renewed, being directed especially against the mutilators of the Hermae. The vast number of arrests and condemnations largely contributed to the growth of the dissatisfaction with the existing form of the democracy. And when at last the real authors of the sacrilege were, as it was thought, discovered and punished, it was determined, contrary to the agreement, to proceed against Alcibiades. Ever since his departure public sentiment had been cultivated most maliciously against him; and when the accusation of violation of the mysteries was now renewed by the oligarch Thessalus, Cimon's son, the commons voted to recall Alcibiades to answer the charge at Athens.

The government despatch ship "Salaminia," which was to bring back Alcibiades from Sicily, found the Athenian army, in the middle of August, at Catania. The Athenian armament, which made rendezvous at Coreyra, consisted of 136 ships of war (100 being Athenian), 30 freight-ships, 100 smaller boats, and 6430 soldiers, of whom more than 2000 were Athenians, — the most brilliant armament that Athens had ever fitted out. But in the western waters it met with unexpected difficulties. Its magnitude excited the suspicions of the friendly Italiote and Siceliote cities, and information from Egesta made it clear that the Athenian ambassadors had been deceived as to the resources of that city. The proposal which Nicias made in a council of war, held at Rhegium, under these circumstances, merely to show the Athenian flag on the Sicilian coasts, and to effect a reconciliation between Egesta and Selinus, did not prevail. Unfortunately, too, even Alcibiades did not side with the energetic Lamachus, whose sensible advice was to proceed immediately against Syracuse, now totally unprepared, and torn by internal factions. Thus the plan of Alcibiades came to be

adopted, which was, by means of extensive negotiations, to draw away the Siceliotas and Sicels from Syracuse and Selinus, and only when the Athenians had won a broad basis to try an attack upon Syracuse. Naxos and Catana had already been secured, when the "Salaminia" came for Alcibiades. It was not his intention, of course, to appear before a court where his condemnation was easy to foresee. He followed the "Salaminia," therefore, on the return, only as far as Thurii in Italy, where he suddenly disappeared, to appear again sometime later at Cyllene in Elis. Not presenting himself at Athens, he was condemned to death in his absence, and his property confiscated, while the whole of the priesthood of the land had to invoke the curse of the nation upon the 'arch-traitor and blasphemer.' When Alcibiades heard this, he gave way to the passion for revenge, and did his best to bring the heaviest misfortune upon Athens. He resolved to throw himself into the arms of the Spartans, that he might use them as instruments of his hate. Appearing near the close of B.C. 413 at Sparta, he proved to be the teacher whom they needed to develop the boldness, the far-reaching wisdom, and the unscrupulousness with which they finally shattered the power of Athens. Alcibiades urged upon the Spartans the energetic support of the Syracusans. His recall had at first brought the operations of the Athenians in Sicily to a standstill. But Nicias at last roused himself, and brought Syracuse, after the beginning of the year 414, into such straits, that the city, already almost surrounded by the Athenian walls of circumvallation, was at the point of surrender. Just then a move, suggested by Alcibiades, changed everything against the Athenians. Not long after his arrival in Sparta, ambassadors came from the Syracusan Hermocrates, and from Corinth, seeking help for Syracuse. Alcibiades frightened the Spartan authorities by showing them that the ultimate object of the Athenian expedition was the overthrow of the Spartan power. By his urgent advice they sent their best general, the energetic and skilful Gylippus, toward the end of May, 414, with a Corinthian fleet to Sicily. In July, Gylippus made his way into Syracuse with 2000 men. Here he took command immediately, succeeded in preventing the completion of the circumvallation of the city, and then within a short time brought the Athenians into a very critical plight. Lamachus had long since fallen. Nicias had not the moral courage to resolve promptly to give up a lost cause, and expose himself to the anger of the Athenian people. When now, in the middle of the second winter, he frankly described in a letter his wretched situation, saying that it was necessary either to recall the

army or to send out re-enforcements equal in strength to the original force, and asking, at the same time, to be relieved of command, the Athenians, with a firmness that was worthy of respect, but in its consequences inexpressibly calamitous, determined to continue the war. Demosthenes was commissioned to get ready, before spring, a new armament, on the most extensive scale.

This was accomplished under dangerously altered circumstances. With Macedonia, indeed, good relations had continued since 415. When Perdiccas died in 413, his illegitimate son, Archelaus, first as guardian of his legitimate brother, who was under age, and then, after the vile murder of the latter, as king, continued the friendly relations to Athens. But the case was different in the Peloponnese. In the course of the perpetual friction between Argos and Sparta, the Spartans had, in the summer of 414, laid waste a large part of Argolis. At the appeal of the Argives, the Athenians appeared with 30 ships, and gave to the Spartans a welcome pretext by ravaging Prasiæ and Epidaurus-Limera. Considering that the right was now on their side, Sparta declared open war against Athens; and in April, 413, King Agis again led a Peloponnesian army across the Isthmus, this time to establish in Attica a fortress with a standing garrison. By the crafty advice of Alcibiades, Decelea (now Tatro), only about fourteen miles northeast of Athens, was selected as the best point from which to cover Athens, as well as overlook and ravage the whole country. This move, unfortunately, did not prevent the departure of the new fleet for Syracuse. Before the eyes of the garrison of Decelea, Demosthenes set sail with 73 triremes, 5000 hoplites, and many light-armed troops for Sicily, where he arrived just after the hard-pressed Athenians had been beaten in open fight at sea by the Syracusans, who had been trained by Corinthian seamen. The arrival of the new armament restored the courage of the army of Nicias. But after the plan of Demosthenes to recapture by storm the heights which commanded the city had failed, by reason of untoward accidents, and through no fault of his, and the battle had ended in a defeat of the Athenians, this prudent leader insisted on leaving at once the untenable position before Syracuse. Nicias stubbornly refused, nor did he yield until the evils of the climate and the re-enforcements received by the Syracusans made a longer delay impossible. The night of August 27, B.C. 413, was appointed for departure; but an eclipse of the moon occurred, and sudden terror seized the superstitious army. Nicias, who in his unfortunate bigotry depended entirely on soothsayers, now lost several days more, and with them the

only chance of rescue, for the Syracusans now did everything to prevent the escape of the Athenians from Sicily. Even when by a last naval defeat retreat by sea was cut off, a full day was lost before they set off by land. On this desperate march into the interior, the goal of which was probably Camarina (possibly Catana), they were pursued by the Syracusans; the two columns of Nicias and Demosthenes were separated, and practically the whole army was destroyed or captured. Of the captives, most perished or were sold as slaves. Nicias and Demosthenes were put to death in Syracuse.

This terrible catastrophe, by which the Athenians lost 200 ships and nearly 60,000 men, really decided the issue of the Peloponnesian war. For now when the strength of the Athenians seemed broken, not only did the Spartans and Corinthians prepare for the last stroke, but the Syracusans sought revenge for the three years of danger they had endured, and even the Persians began to hope again to plant their banner everywhere on the coast of Asia Minor. And finally, within the Athenian empire, the disposition to revolt began to grow stronger, and in the heart of the capital city itself the tendency to an oligarchic revolution became more manifest. Above all, the Athenians felt the significance of the Spartan occupation of Decelea. Safe only within the immediate vicinity of the city walls, they were obliged to import the products of Euboea, their storehouse for corn and meat, around Sunium to the city, and 20,000 slaves seized the opportunity to steal away to the Spartans. It was soon evident that along the whole line from Syracuse to Sardis, preparations and intrigues were on foot for the destruction of the remnant of Athenian power. And yet this wonderful people, after they had overcome the overwhelming grief of the first moment, resolved once more to continue the life and death struggle to the last drachma and the last man.

The news from Sicily in the autumn of 413 caused the Persian satraps in Asia Minor, the chivalrous Pharnabazus at Dascylium, the intriguer Tissaphernes at Sardis, as well as the oligarchs of the Ionian districts, especially of the island of Chios, to enter into direct alliance with Sparta. It was Alcibiades, again, who induced the most influential Spartans to begin the destruction of the Athenian league, hand in hand with Tissaphernes, first in Ionia, where they could count on the fleet of the Chians, and where the revengeful exile himself had most political connections. The Spartans hoped in the campaign of the summer of B.C. 412 to overthrow the whole colonial power of the Athenians. In the winter of 413-412 Chios and Erythrae were admitted — at first

secretly — into the Peloponnesian alliance. The Spartans, now aware that they could destroy Athens only by the help of ready money and a strong fleet, decreed for themselves and their allies the fitting out of a hundred ships. But the Athenians also, in spite of the severe financial stress, made new preparations, and with wonderful energy struck a successful first blow in the new campaign. The Spartan expedition to Asia Minor was to set out in the spring of 412 from the eastern ports of Corinth. When the Athenians learned that, they drove with twenty-eight ships (April or May) twenty-one hostile vessels, which had put to sea from Cenchreae, into the deserted port of Piraeum, on the Epidaurian frontier, inflicted a severe defeat on them, and finally held them closely blockaded. Among the Spartans this caused such consternation that they even thought of giving up the Ionian expedition. Then the destroyer of Athens, Alcibiades, prevailed with the ephors to make the attempt on Ionia, even with the smallest force; and sailed himself with the admiral, Chalcideus, with only five ships, reached Chios, and brought this island, with its sixty ships, then the cities of Erythrae and Clazomenae, and finally Teos and Miletus, to open revolt from Athens. That was the beginning of a new phase of the war. At Athens it was necessary now to lay hands on the financial and naval reserve created by Pericles. In Ionia, however, Alcibiades and Chalcideus without scruple concluded for Sparta with Tissaphernes the first of those shameful treaties which already were to indicate the meaning of the new 'freedom' which Sparta proposed to give to the Greeks. Provisions and high pay were demanded for the Peloponnesians; in return, it was agreed that the Great King should have all the land and cities that he now owned and that his forefathers had possessed. Immediately the Chians brought Lebedos and Erae, then all Lesbos, to revolt from Athens. The fleet that was blockaded at Piraeum finally cut its way out, and was led over to Chios by the Spartan Astyochus, the incumbent of the new annual office of navarch, or chief admiral, which had been made independent of the power of the kings.

On Samos, too, the aristocracy began to bestir themselves; but the commons of this important island declared for Athens, and with the help of the crews of three Athenian men-of-war put down the nobility. Samos, which now adopted a strongly democratic form of government, received in gratitude from Athens full autonomy and the freest federal relation; and to the last it held most faithfully to the Athenians. Thus the Athenians won, in the midst of the revolted territories, a broad and

sure basis for the war. When their new fleet had, in the latter half of the summer, attained respectable strength, they won back, in quick succession, Teos, Mytilene, Methymna, Clazomenae, laid waste Chios, and, after a successful battle in September, threatened even Miletus. The arrival of the hostile fleet of 55 ships, including 22 Sicilian triremes, under Hermocrates, and the haste with which Alcibiades directed these to Miletus, caused the Athenians to withdraw at once to Samos. The Athenian generals knew well that Athens could not now raise another fleet. A defeat would have been fatal to Athens, while even the severest losses at sea would not have crushed the Spartans. Just then the Spartans began to exhibit a slackness and want of system which was as unexpected as welcome to the Athenians. It was the result of the sudden alienation of Alcibiades from the Spartans. The brilliant successes of the latter had roused the strongest jealousy among a large party at Sparta. Now that his diplomacy and energy had won for Sparta a firm foothold in Asia, he was unnecessary, and, with his influence in Sparta and with the Persians, very much in the way. He must, therefore, according to the approved custom of the Lacedaemonians, be murdered before he could become dangerous. But Alcibiades — warned in time by a friend — escaped from Miletus to the Persians (October, 412), and found at the court of Tissaphernes a very cordial welcome, especially as he displayed astonishing skill in acquiring the language, customs, and manners of the Persian nobility. He soon became the most influential and trusted adviser of the satrap. Alcibiades proposed to regain the favor of the Athenians by breaking off the alliance between the Persians and Peloponnesians, and effecting one between the former and Athens. But here he overestimated his strength. The only permanent result of his activity at the satrap's court was, that he showed the Persians how to take advantage of the dissensions of the Greeks. Alcibiades made clear to Tissaphernes that it was not to Persian interest to bring the war to a speedy issue. He should rather let the two combatants mutually weaken themselves, and especially not furnish the Peloponnesians too much money, since the complete triumph of the Spartans might easily become more dangerous than that of the Athenians. The satrap heeded this advice, and held back his subsidies and re-enforcements. Beyond that Alcibiades could not persuade him to go. Still, the cunning fugitive had already attracted the attention, and to some extent even the sympathy, of various elements in the Athenian station at Samos. Alcibiades knew that not a few prominent men in the camp on Samos wished to change the

constitution into an oligarchy, thinking thereby ultimately to secure better terms from Sparta. He entered, therefore, into negotiations with the most prominent oligarchs, and promised to secure for them considerable sums of money from Tissaphernes, and even the friendship of the Great King, in case they really succeeded in overthrowing the democracy. The oligarchic conspirators sent, at the beginning of the year 411, Pisander to Athens, in order to secure the consent of the commons to the negotiations with Alcibiades and Tissaphernes, and secretly to unite the clubs of oligarchic sympathies for a great blow against the democratic constitution. Phrynichus, who was strongly opposed to the plans of Alcibiades, was removed from the command at Samos, and at the end of January, 411, negotiations were opened with Tissaphernes. But the satrap now showed himself by no means inclined to break with the Peloponnesians, nor could Alcibiades induce him to consider seriously the proposals of the Athenian oligarchs. In order therefore not to let it be seen that he had greatly exaggerated his influence with Tissaphernes, Alcibiades resorted to the base means of announcing such extreme demands on the Attic commissioners as the price of the Persian alliance, that the negotiations necessarily fell through.

Meanwhile the oligarchic conspirators, who had already entered into an alliance with the Samians, had gone much too far to stop; they proceeded now, regardless of consequences, to overthrow the democracy at Athens. For this purpose several politicians were working with some skill. Antiphon, the shrewdest counsellor of the party, the highly gifted Theramenes, Phrynichus, the resolute antagonist of Alcibiades, and many others, strove to agitate the people and to confuse the public mind. The defection of many men, who had previously passed for radical demagogues, from the cause of the ancient constitution; the lukewarmness of many wealthy citizens who had been turned against the democracy by the events of recent years; finally, the murder of several troublesome demagogues, — made the mass of the Athenian commonalty, the flower of which was at the time in the camp at Samos, defenceless and passive. When Pisander arrived at Athens from the Cyclades, where he had established oligarchies at all points (April, B.C. 411), with a troop of young patrician warriors, the people were easily forced, without scenes of violence, to abolish the old constitution. In the new constitution the Ecclesia was to consist of 5000 of the wealthiest citizens, public pay for all kinds of civil duties to cease. A committee of five men chose a new oligarchic Boulé of 400 men.

But there they stopped for the time; the 5000 seem not to have been chosen. But soon the oligarchs suffered reverses on all hands, which opened the way once more for a display of the strength of the demos. The oligarchic revolution that was preparing in Samos was crushed by the commons with the help of the strategi, Leon and Diomedon, the trierarch Thrasybulus, and the influential hoplite Thrasyllus. As soon as the news of the state of affairs in Athens reached Samos, the army, under the lead of Thrasybulus and Thrasyllus, openly revolted from the oligarchy, allied itself with the commons of Samos, replaced all suspected officers by tried democrats, and on the advice of Thrasybulus summoned Alcibiades to Samos. This armed democracy was so influenced by the magic of his eloquence, and by his promises of Persian gold, that they elected him commander-in-chief. Having now the dangerous alternative, either to follow the will of the army and to take the field against the oligarchy at home, leaving Ionia for the moment to the Peloponnesians, or to continue the war in the face of every danger to which Athens might meanwhile be exposed through the policy of the revolutionary party, Alcibiades decided with monstrous audacity for the latter course. This time fortune favored him in an unhoped-for manner. Tissaphernes had, in March, 411, concluded at Magnesia, with the Spartan Lichas, a new treaty, whereby a separate treaty with Athens was prohibited. The Peloponnesians guaranteed to the Persians only the territory then possessed by them in Asia, while the satrap bound himself to furnish them pay according to the treaty until the arrival of the Phoenician fleet. Still, he did not summon the Phoenician fleet, and paid the money as badly as before. Finally, to save appearances, he betook himself, June, 411, to Aspendus, in Pamphylia, on the pretext of bringing up the Phoenician fleet anchored there, Alcibiades following him with a squadron of observation.

On his return to Samos, Alcibiades found the situation entirely changed. At Athens the short-lived oligarchy had collapsed. The attitude of the army, and the loss of all hope of peace with Sparta, had split the dominant party at Athens into a radical minority under Antiphon, Phrynichus, and Pisander, and a more moderate majority under Theramenes. The oligarchy broke down when a Spartan fleet of forty-two sail under Agesandridas overpowered the Athenian fleet under Thymochares in the straits of Euboea, and then caused the island of Euboea (except Oreus), which was almost indispensable to Athens, to revolt. The commons in the city now rose (middle of June), over-

threw the oligarchic fanatics, restored the Boulé of 500, and decreed that public service should be without compensation, and the Ecclesia limited to citizens who could, from their own means, furnish a complete hoplite outfit. On motion of Critias, Alcibiades was recalled, and peace made with the army (early in July, 411). Meanwhile the external power of Athens was seriously threatened at another critical point.

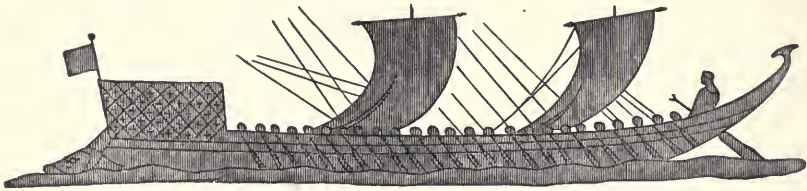

FIG. 155. — Penteconter; from a vase painting. (After Panofka.)

As soon as the Spartan navarch Mindarus had learned that Tissaphernes had no thought of leaving the Pamphylian coast with the royal fleet, he turned toward the Hellespont that he might co-operate with the more reliable Pharnabazus, and possibly cut off Athens entirely from the Euxine, which had been, since the fall of Euboea, her most important source of supplies. Early in the summer, Dercyllidas, starting from Miletus, wrested Abydos and Lampsacus from the Athenians, and soon after the able Clearchus took Byzantium. In July, Mindarus also set off from Miletus for the Hellespont with the main fleet of seventy-three sail. Thrasybulus and Thrasyllus followed the Peloponnesians without delay, and won, about the end of July—for the first time since Syracuse—at Cynossema, near Abydos, a brilliant naval victory over the enemy. This victory, and the destruction of Agesandridas with fifty ships (cf. Figs. 155, 156) in a terrible storm at Athos,

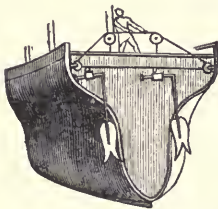

FIG. 156.—Construction of the hull. (After Graser.)

put a stop to the advance of the Peloponnesians on the Hellespont.

Alcibiades returned to Samos not long after the battle of Cynossema, and learned there the good news from Athens and of the victory of Thrasybulus. But he was hindered from carrying on the war effectively by a cause which repeatedly crippled Athenian action, namely, lack of money. The Athenian finances had naturally fallen into considerable disorder; and a practice discreditable to the Attic flag had come into use, namely, that the Athenian naval commanders themselves collected the tributes, which thus acquired more and more the charac-

ter of taxes. Alcibiades had to spend several months cruising with twenty-two ships in the Carian waters, and collecting from revolted territories money for carrying on the war. Turning now, in October, 411, to the Hellespont, he won immediately a great success. At Abydos a hot fight was raging between the Athenians and a much larger hostile fleet covered by the land army of Pharnabazus. Toward evening the situation was critical for the Athenians, when Alcibiades arrived from the south with eighteen ships, and by his energy and quickness won a speedy victory over the foe. The hostile fleets now lay again watching each other near Sestos and Abydos. But at the beginning of March, 410 B.C., Alcibiades followed the enemy to the Propontis, where, with Pharnabazus, they had occupied Cyzicus, and with brilliant tactical skill won there over Mindarus, who was himself slain, the Syracusans and Persians, the most imposing victory of the war (cf. Fig. 154). At Athens the democracy, as it seems, was now restored as it had been before the revolution in 411, including the pay of the dicasts and ecclesiasts, and money for the theatre. The radical demagogues also recovered their influence, especially Cleophon, who prevented the acceptance of the peace proposal, that each power retain its present possessions, which Sparta now offered. Alcibiades and the other generals were meanwhile turning their victory to account. The former, establishing himself at Lampsacus, collected toll from the passing vessels, and plundered the territory of Pharnabazus. And when in the year 409 he had wrested Chalcedon from the Peloponnesians, soon afterwards surprised Selymbria, concluded a truce with Pharnabazus, and late in the autumn had taken even Byzantium by storm, the war in this region was for the present at an end. Pharnabazus granted safe conduct to an Athenian embassy, which was to treat with the king at Susa about an alliance. Alcibiades went to Athens, conducted his splendid triumphal procession in June, B.C. 408, and atoned for the old guilt toward the mysteries by protecting the sacred procession to Eleusis with his soldiers against the Spartans at Decelea.

But full atonement for his political fault toward Athens was denied him. When he left the Piræus, toward the end of September, 408, with 100 ships of war, clothed with new military powers, and again made Samos the basis from which to reconquer Ionia, he found the situation on the theatre of war changed for the worse, and himself



FIG. 157—Trophy.
Token of victory
on a Boeotian
coin.

opposed to two such antagonists as Athens had not yet had to contend with. In Susa the policy just now was to hold fast to the alliance with Sparta. And late in the summer of 408 the younger son of Darius II., Cyrus, a highly gifted, impetuous youth, who displayed the genuine traits of the ancient Achaemenidean house, and shared in full measure the deeply rooted aversion of his people for Athens, appeared at Sardis as *caranus*, or viceroy, and commander-in-chief for all satrapies west of the Halys. His shrewd mother, Parysatis, of whom he was the favorite, had secured his appointment. She wished to see a close alliance made with the Spartans, with whose help he might, on the death of his father, seize the crown. Under these circumstances even Tissaphernes could do nothing with his shrewd see-saw policy against the strong sympathies of Cyrus for Sparta, which a new navarch, likewise just arrived in Ionia, understood how to arouse, and to turn to the fullest advantage of his government. This man was Lysander, son of a Heraclide and of a Helot woman. In his outward bearing the type of an austere, rigid Spartan of the olden time, he was animated by a burning ambition, which aimed at nothing less than to extend Sparta's authority over the whole of Greece, and then to win for himself the leading place in the state. Lysander was the ideal type of the Spartans as they were developed by the war. Perfectly indifferent to the racial connection with his Athenian opponents, and to the national Hellenic idea; thinking only of destroying Athens at any cost,—he united with the discipline of the olden time and with a fearful consistency of action, a rare gift of easy intercourse with people of every sort. Besides, he was cold-blooded, self-controlled, crafty, grateful for real favors, as well as revengeful, and utterly indifferent to the nature of the means he employed. An able statesman, quick and energetic, and an excellent general, he became the destroyer of Athens. This Lysander, who with seventy ships now made Ephesus headquarters for the new war, prepared the way for his own and Sparta's final victory, and the ruin of the Athenians and of democracy, by bringing into connection with one another and with him, all the oligarchical clubs, open and secret, in all parts of the Greek world, but especially on the islands and in Asia, and by establishing new clubs everywhere. Thus the power of Athens was undermined, and all Greece surrounded with a network whose threads he alone held in his hands. He established in every city won by him those oligarchical governments, which, under the name of decarchies or decadarchies, were composed of the wildest fanatics, and were sustained by Lacedaemonian harmosts, with the help

of Peloponnesian garrisons. Thanks to the personal friendship of Cyrus, he received considerable sums of money with which he could keep the pay of the Peloponnesian seamen higher than that of the Athenian, and thereby cause many mercenaries to desert the latter. With such a dangerous antagonist abroad, it was of evil import for Alcibiades that his enemies at home remitted not in their hatred and distrust, and only waited for the moment when the popular feeling for him should cool down. The Athenians, who overestimated his strength, were quite ready to ascribe every failure to his personal fault. Ill successes were not wanting. Lysander avoided battle, and only enticed Athenian seamen by higher pay. The disillusion put the army at Samos out of humor, still more the Athenians at home, who believed everything that the enemies of Alcibiades told of his reputed frivolous and luxurious ways. When, finally, during his temporary absence, Antiochus, whom he had left in charge, contrary to his express command, attacked the Peloponnesians at Notium and lost fifteen ships, the popularity of Alcibiades was gone forever. The commons did not renew the chief command for him, but elected, in the spring of 407, ten new strategi, among whom Conon was the most capable. Alcibiades retired to some castles on the Thracian coast of the Propontis, which he had recently built for such a contingency.

Conon reduced the fleet to 70 of the best ships with excellent crews, but for the present could only continue the war in the form of plundering expeditions. The Spartan Callicratidas, commander of the Peloponnesian fleet in B.C. 406, aroused Chios and Miletus to such efforts that with 140 ships he was able to defeat Conon, and to shut him up in the harbor of Mytilene. It would probably have been well for Athens if the war could have ended with this humiliation, and instead of Lysander, Callicratidas, a man of honorable, chivalrous disposition, who still regarded even his opponents always as Greeks, could have dictated terms of peace. But the commons of Athens roused themselves once more with wonderful energy. Exerting themselves to the utmost,¹ and with the help of the Samians, they fitted out within four weeks 155 ships, with which the strategi Thrasyllus, Pericles (son of the great Pericles), Protomachus, and Aristogenes sailed to Conon's relief, and in September, B.C. 406, met, in the strait between Lesbos and Aeolis, at the islands called Arginusae, the 120 ships of Callicratidas, and destroyed all but 43. The brave Spartan himself fell; the flag of Athens once

¹ The whole Peloponnesian war cost Athens in direct public expenses fully 35,000 talents, or about \$37,000,000.

more waved victorious over the waters. Sparta now proposed peace, each side to retain its present possessions; but the Athenians, intoxicated with success, rejected the offer. The glory of the victory was clouded by a sad incident. A storm, which came on directly after the battle, made it impossible to rescue most of the seamen from the wrecked vessels of the Athenians, and to collect for burial the floating corpses, a sacred duty of ancient generals. The Athenians were so enraged on hearing of this that they immediately deposed the commanders, and summoned them to Athens. Only two, who recognized the greatness of the danger, were shrewd enough not to obey. The remainder were arrested, tried before the Ecclesia, condemned, largely through the efforts of the oligarchs, and executed.

The Spartan government was induced, by the requests of the oligarchies of Asia Minor and of Cyrus, to place Lysander again, for the year B.C. 405, in command of the fleet. As no one could twice hold the office of navarch, Aratus received the nominal appointment, while Lysander, as *epistoleus*, or second in command, had the real authority, and was supplied by Cyrus with abundant means for his new armaments. First, Lampsacus was captured, at the opening of the campaign, by Lysander; and, as a result, the Athenian fleet was obliged to station itself in a most unfavorable position, at the brook Aegospotami, near Sestos. The Athenians grew careless as the Peloponnesians refused their repeated offers of battle; and their commanders neglected and despised the warnings of Conon and of Alcibiades, who came from his neighboring castles to urge them to be on their guard. Lysander was thus able (in August, 405), to surprise the Athenians, and easily destroy their fleet, only Conon and 12 ships (out of 160) escaping. Lysander had 3000 captives put to death by decree of his military court, and, contrary to all precedent, did not even allow the bodies honorable burial. Then he proceeded systematically to destroy the remnants of the gigantic structure which Cimon and Pericles had built. Everywhere Athenian authority and democracy were overthrown, and oligarchical decarchies and Lacedaemonian harmosts substituted. All Athenian troops and cleruchs were compelled to return to Athens, that she might the sooner be reduced by famine. Scione, Melos, and Aegina were restored to the posterity of their ancient inhabitants. Finally the hosts of all Hellas gathered around Athens itself. King Agis advanced from Decelea against the eastern and northern side of the city; Pausanias, son and successor (since 408) of Plistoanax, led the whole land force of Sparta and her allies against

the west side of Athens; while Lysander, with nearly 200 ships, appeared late in the autumn before the Piræus.

The resistance of the Athenian commons could even now be only gradually broken down. The oligarchy secretly made away with some of the demagogues, and secured an extensive amnesty in their own interests. Hunger worked still more effectually. The Athenians were finally so disheartened that they were willing to renounce all possessions outside of Attica, and even thought of acknowledging the Spartan hegemony. Only the destruction of the Long Walls they would not consent to. But just this was the purpose of the Spartans and of the oligarchy. Theramenes purposely idled away, as ambassador at Sparta, almost four months, while famine played havoc at home. In the decisive negotiations which he and nine colleagues conducted at Sparta, the attitude taken toward the prostrate Athenian people was that of a penal court. Only Spartan interest prevented Athens from being simply extirpated, as the Boeotians and Corinthians demanded. The conditions which the starving Athenians finally accepted, in April, B.C. 404, were, that they should restrict themselves to Attica, level the Long Walls and the fortifications of Piræus, join the Spartan alliance, render military service to the Spartans, and deliver up all but twelve ships. The walls were immediately levelled, the arsenals destroyed, the city of Athens reduced to the humble position it had occupied before Themistocles and Cimon, only its existence preserved. The wish of the Hellenic people was fulfilled, — the empire of Athens was completely destroyed, and Sparta was now the only Greek power. Democracy was considered dead in Hellas. Even the stubborn Samos had to yield toward the end of the summer of 404, and accept an oligarchical form of government. Greek freedom triumphed; that is, the Spartan conception of it prevailed.

The Attic oligarchs and Lysander did not rest till they had stamped out the democracy in Athens. As soon as the fleet was delivered up, Theramenes and his friends, by false accusations, got rid of several able leaders of the moderate democracy, and were strengthened by the many returning oligarchic exiles, among whom Critias was the most prominent. The latter was a man of the ancient nobility, cultured, shrewd, and clever, but in the highest degree ambitious and a most unscrupulous partisan. He was the most influential member of the five 'ephors' (as the directors of the oligarchical clubs were called) who for the moment were at the head of affairs. The time for action was not deemed ripe until after the retirement of the Peloponnesian army. Then, in June, B.C. 404,

Lysander at the call of Critias and Theramenes returned from Samos with a strong force to the Piræus and by threats forced the Ecclesia to adopt the proposal of Dracontides, to commit the government to the hands of thirty men, who were to manage the business of state until they had drawn up a new constitution. These 'Thirty,' nominated forthwith, partly by the ephors, partly by Theramenes, partly by the fragment of the Ecclesia, were the counterpart of the decarchies of Lysander, and consisted of the chosen leaders of the Athenian oligarchy. Their appointment was approved by Sparta; and, for their protection, seven hundred Lacedæmonian hoplites under Callibius took possession of the Acropolis, in October, 404.

Meanwhile unhappy Sicily fared but little better than the great state whose power she had broken. On the failure of the Athenian expedition, the terrified Egæsteans applied to Carthage for aid, which was readily and effectually granted. The Syracusans, disheartened by military disasters and torn by dissensions, fell an easy prey into the hands of the ruthless tyrant Dionysius I., who in 404 concluded a disgraceful peace with Carthage. By the terms of this treaty, Himera, Selinus, Agrigentum, Gela, and Camarina were to be without walls and to pay tribute to Carthage. Messana, Leontini, and the Sicels remained free; and Dionysius was recognized as prince of Syracuse.

From the ruins of Himera to the Bosphorus, Hellas presented, in the summer of 404, a sad spectacle. Her power was terribly weakened; many thousands of soldiers and sailors had fallen in battle, or been murdered after defeat; the material loss which the contending powers had inflicted on each other, and the barbarians on both, amounted to untold millions of drachmæ. Great and apparently hopeless was the demoralization which this horrible fratricidal civil war had brought into almost all the communities of the great Hellenic people. But such was the energy of this incomparably gifted nation that it was yet too early to talk of exhaustion. Above all did unhappy Athens challenge admiration, where, notwithstanding the strain of the war, spiritual and intellectual interests—religion, art, poetry, and science—were cultivated with unabated energy. The flourishing period of poetry, especially of the dramatic art, was by no means over (Fig. 158¹). The

¹ Every important Greek city had its theatre, which was used for dramatic representations and for certain public meetings. From the ruins, from works of art, and from the statements of ancient writers, the restoration of the typical Greek theatre is a matter of no great difficulty. According to a theory lately urged—but not without meeting opposition—it is highly probable that the theatre of the Fifth Century had no stage, and that actors and chorus performed their parts on the same level. — Ed.

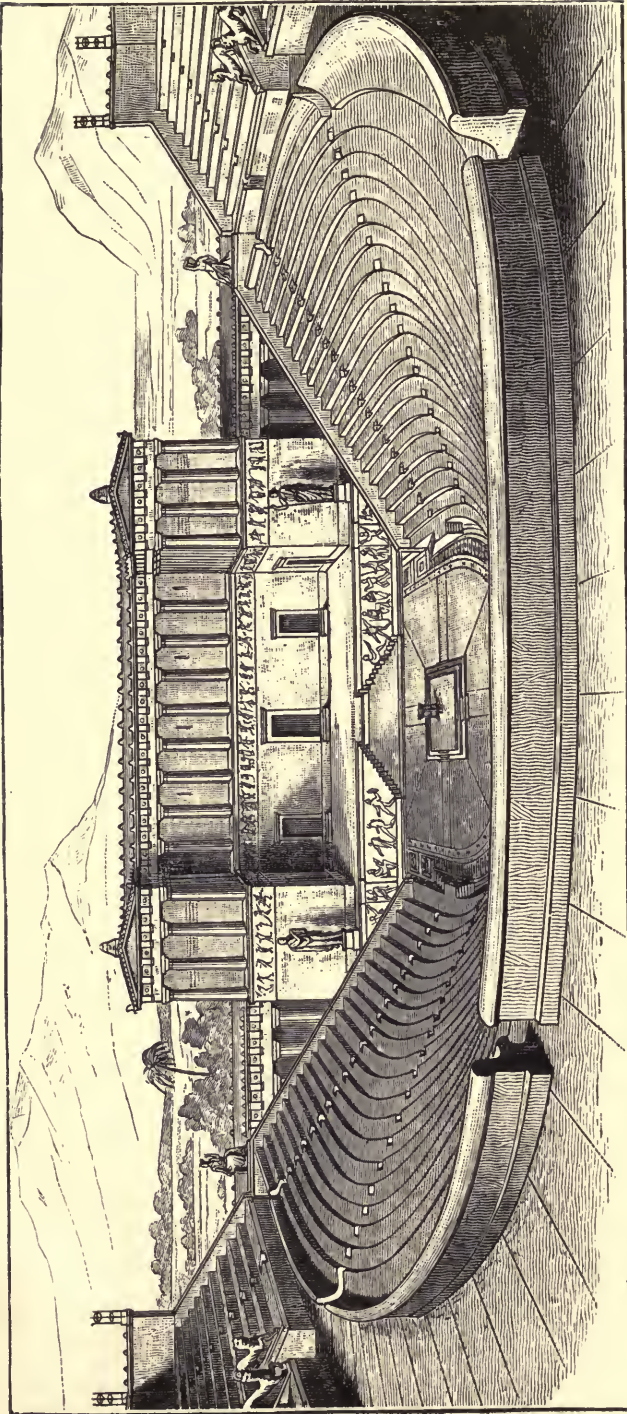

FIG. 138. — Theatre at Egesta in Sicily, with stone seats. (Restoration.)

“naughty favorite of the Graces,” the gifted Aristophanes, had with his muse uninterruptedly followed the events of the time in numerous comedies, until at last his “Frogs” point to the time when politics no longer furnished the motive for the comic stage. Especially rich was the development of tragic poetry. Besides Sophocles, who until his death (406–405) remained the honored favorite of the Athenians, a number of younger poets appeared, native Athenians, and foreign Greeks who had settled at Athens. The best of these tragic poets of the second rank was Agathon, son of Tisamenus, prominent after B.C. 416, rich, talented, schooled in the teachings of the Sophists and in rhetoric. But the same age enjoyed also the creations of a poet of the first rank, whom the Greek world placed with Aeschylus and Sophocles in the canon of the great triad. This was Euripides (Fig. 159),



FIG. 159. — Euripides. (After Visconti.)

born of humble parents on the day of the victory of Salamis, a pupil of Anaxagoras, later an intimate friend of Socrates. His art, which, though attacked by the biting criticism of Aristophanes, won more and more the favor of the public, exhibited deep and sympathetic knowledge of the human heart, and with rich inventive power and great originality united reflection and philosophy with brilliant poetic fire. Euripides, who died shortly before Sophocles, closed his life in Macedonia, whither he had gone in 408 on the invitation of king Archelaus, who, in that semi-barbarous land, posed as

a patron of civilization and culture. Here also we should mention the representative of the purest ethics of this period, the already aged Socrates (born about 470 B.C.), the father of the new philosophy, the glory of which began from this time to rival that of Athenian poetry, and at last surpassed it.

With such means, Athens, even in her ruins, towered high above her brutal enemies and conquerors. But from the verdict of the god of battle there is no appeal. The blunders of the Athenians themselves and the superior power of their antagonists had overthrown all save a feeble remnant of the material empire which was the creation of Themistocles, of Cimon, and of Pericles. Victorious Sparta was now undisputed mistress of Hellas. What use would she make of her exalted position?

CHAPTER XIII.

SPARTAN SUPREMACY UNTIL THE PEACE OF ANTALCIDAS.

(B.C. 404-387.)

WHEN Lysander returned home in triumph, after the conquest of Samos, with the conquered Attic ships and with a treasure of 470 talents, his state occupied a higher position than ever before. Far and wide there was no power which Sparta need fear, or even respect. But the Hellenes soon found that they had hitherto neither really known Sparta, nor had they observed how much her old excellent character had changed during the war. The Spartans proved entirely incapable of making any other use of their new position than that of a brutal and selfish despotism. Their friendship with Persia hindered them from maintaining the independence of the Greek states of Asia. What the new freedom meant under Lysander's supremacy was soon apparent. One heard only of deeds of revenge of the Spartans upon such communities as had held to Athens long and faithfully, or had not held to Sparta. One heard only of violent and base acts of the Lacedaemonian harmosts. And against such things, as well as against the wantonness of the Lysandrian decarchies, there was no legal protection at Sparta. The former allies of Athens had, even after the close of the war, to pay to Sparta the hateful tribute. States of lesser power, such as Thebes and Corinth, were forced to recognize that where Sparta no longer needed their help she paid no regard to their special interests, wishes, and views. So there soon grew up, along with the intense hate of the crushed democracy, a deep and general aversion to the new supremacy of Sparta. Not yet, indeed, did the old or the new enemies of Sparta know that the internal strength of this state was seriously threatened by the new expansion. Spartan discipline rarely stood firm abroad. The command of enormous sums of money had a corrupting influence on the Spartans, among whose most influential men bribery had long been a common evil. The oligarchical elements in Sparta abridged more and more the remains of monarchical power, a tendency clearly shown in the separation of the navy from the juris-

diction of the kings, and in the subordination of the harmosts to the ephors. As the rule of the oligarchs became more strict, dissatisfaction dangerously increased at home as well as abroad, and not only among the Perioeci and Helots, but even among the Spartans themselves. Here a strong opposition had gradually developed between the proud *Homoioi*, or full citizens, and the numerous Spartans who, on account of their poverty, could no longer participate in the *syssitia*, and were therefore excluded from full citizenship (the *Hypomeiones*). Sparta needed a reformer of the highest order to master the mighty evils that were consuming the marrow of the state. But her greatest statesman, Lysander, though an incipient revolutionist, was no reformer. The immense power which he possessed, through his reputation and his connection with the oligarchic clubs, was opposed to all Spartan precedent. And now the jealousy shown by the kings and ephors for his superior power caused the destruction of a part of his work, and at the same time weakened considerably the Spartan supremacy which he had established.

That was apparent in the year B.C. 403, when the Attic democracy again raised its head. The provisional government of the Thirty, — whom later writers termed the “Thirty Tyrants” — formed in the summer of 404, exercised an intolerable despotism. They abolished the dicasteries and the Areopagus, filled the offices and the Boulé, to which criminal jurisdiction was now given, with adherents of their own, placed the Piræus under a college of ten men, and, supported by the young knights and the foreign troops, inflicted at pleasure exile, confiscation, or death upon all suspected citizens. Alcibiades also became the victim of the hatred and fear of his enemies, — the Thirty, his enemies in Sparta, and the Persian court at Sardis. After the final victory of the Spartans, he had placed himself under the protection of Pharnabazus, and hoped to warn king Artaxerxes II. (Mnemon) of the plot of his brother Cyrus, and so win him for Athens. Pharnabazus was induced, as it seems by commands from Sardis, to have his guest-friend murdered, on his journey to Susa, in the Phrygian village of Melissa, toward the end of the year 404. The character of the oligarchic despotism at Athens became more and more malignant after Critias secured the condemnation of Theramenes, who had come to take a more moderate attitude. The oligarchs, however, to give an appearance of greater strength to their position, actually took steps to organize an *Ecclesia* of 3000 citizens. Under these circumstances numerous Athenian exiles and fugitives assembled on the borders. By the end of the year 404

the feeling against Sparta was so strong, that not only Argos, but even Thebes, roundly disobeyed the injunction of Sparta not to protect such fugitives. In Thebes the boldest fugitives assembled, under the celebrated general Thrasybulus and the tanner Anytus. At first only seventy-three in number, they seized and fortified (late in 403), the border castle Phyle, on Mt. Parnes, only about twelve miles from Athens. As their number grew, the oligarchs — the knights and the 'Three Thousand' — made an assault upon them, which failed completely. A new victory, which Thrasybulus won with seven hundred men at Acharnae, brought to him increasing numbers; and he was soon able to capture the Piraeus, occupy Munichia, and in this position brilliantly repel an assault of the oligarchs. As Critias was slain in this battle, the oligarchy divided into two groups. The extremists among the Thirty, and the Three Thousand, withdrew to Eleusis. In Athens the power passed over to a new college of Ten, who, contrary to expectation, proved to be quite as bad as the Thirty had been, and continued to carry out their narrow policy. It was natural, therefore, that this new government at Athens, as the men at Eleusis had already done, should call upon the Spartans for aid (early in 403). Matters looked unfavorable for Thrasybulus when Lysander, as harmost, with 1000 mercenaries, appeared at Eleusis, while his brother Libys with forty ships blockaded the Piraeus. The kings and the ephors in Sparta now finally agreed no longer to leave the ordering of Athenian affairs exclusively to Lysander; and a Peloponnesian army advanced into Attica under king Pausanias. In the mean time the Ten had been succeeded by a Second Ten, thoroughly patriotic men, who were able to effect a reconciliation between the Piraeus and the City parties before the arrival of Pausanias. This is what the best men on both sides had been looking forward to. A peace was thus finally concluded at the end of the summer of 403, which rescued democracy for the Athenians. This was the first great defeat of Lysander and his policy. The Thirty, the former decarchy of the Piraeus, and their hangmen, the so-called 'Eleven,' were to be driven from Athens. On the other hand, the parties in the city and in Piraeus concluded peace and friendship with one another; universal amnesty — in Greek revolutionary conflicts hitherto almost unknown — was proclaimed; all exiles were allowed to return. Pausanias led the division of Callibius and the rest of the troops back to the Peloponnese. Thrasybulus and his army, however, on September 21, amid the rejoicing of the people, entered Athens, where, after solemn ratification of the amnesty, the democratic constitu-

tion was renewed, though with important restrictions. When the new archons were chosen, a series of wise reforms was carried through. Besides a systematic revision of Athenian law, a part of its old political power was restored to the Areopagus, the duty being assigned to it to see that the newly arranged laws were exactly observed and preserved unfalsified. The now useless commission of the Hellenotamiae was abolished; and instead, the new offices of war-treasurer and of manager of the Theoric fund, i. e., the fund for the state festivals, were created. Both funds were to be supplied from the surplus of the yearly revenue. After this time there was in Athens no oligarchical party. But the people were tired of bloodshed; and all attempts of the more violent democrats to evade the amnesty, by private suits or other means, failed completely.

Unfortunately, however, the attempt closely connected therewith — the removal of Socrates (Fig. 160) by legal process — succeeded in



FIG. 160. — Socrates. Herme in Naples. (Photograph.)

399. Although averse to party politics, always a brave soldier, and as citizen faithful in the discharge of his duties, as steadfast an opponent of the lawlessness of the oligarchy as of that of the commons, the philosopher of three-score and ten had aroused strong antipathies. The democratic masses confounded him with the Sophists, and disliked the man who had no sympathy for democracy and its forms, and had been intimate some years before with Critias. Finally, he who had been declared by the Delphic oracle the wisest of all Hellenes, was accused of opposition to religion. A trio of accusers—the influential democrat Anytus, the orator Lycon, and as nominal chief accuser the poet Meletus—brought Socrates before a dicastery, on the charge of “apostasy from the religion of the

fathers, introduction of new gods, and corrupting the youth.” His high-spirited defence, which ran counter to all Attic precedent, and seemed even to exult in the prospect of death, so enraged the dicasts that they pronounced sentence of death, which was executed in May, 399. The Athenians did not then suspect that for many centuries afterwards the city would acquire new glory from the name of Socrates, that even its material prosperity would depend upon the schools of philosophy afterwards founded by his disciples. At this time their

whole effort was directed toward preserving what was left of their prosperity, and opening new sources of material welfare. But it cost endless trouble to make their ruined lands again profitable. Attica never bloomed again as before; there was only a partial restoration of the agricultural class. Main stress was laid upon trade and industry, and in this direction a great future was before the city.

The supremacy of the Spartans remained unshaken only until about the time of Socrates's death. Lysander was not able long to maintain his personal authority. The jealousy of the kings and ephors prepared for him still other humiliations, so that as early as 403 he found himself completely thrust aside. Still, the policy of the Spartan government remained ruthlessly selfish. Soon its vengeance fell upon the Eleans, who during the Peloponnesian war had repeatedly been insubordinate. The war which King Agis II. opened in the spring of 401 against Elis ended in the summer of 400 with the complete ruin of this state. The Eleans lost Triphylia, and had to give up the high land on the east of their capital to Arcadia, to surrender the port of Cyllene with their fleet, and acknowledge the autonomy of the small states north of the Alpheus. Not long afterwards Agis died. In the question of the succession Lysander's influence was again felt. He induced his friend, the universally beloved step-brother of Agis, Agesilaus (born 442-441 B.C.), a man of small stature, insignificant appearance, and lame, but recognized as a Spartan of the best type, and withal of brilliant military talent, to attack the legitimacy of Leotyehides, the apparent heir, and himself claim the throne. Lysander's cleverness secured the election of Agesilaus (summer of 399); for when, at the last moment, the enemies of the latter brought forth an old Delphic oracle, which warned Sparta against a 'lame reign,' Lysander won the majority of the assembly by the clever interpretation that the warning was not against a king bodily lame, but against allowing any man to ascend the throne who was not sprung from the royal blood of the Heraclidae. Lysander now exulted, for he felt perfectly sure of the new king. He was, however, completely deceived. Agesilaus, who soon attached the people to himself by his sociability and pleasant humor, and won the oligarchy and the ephors by his shrewd flexibility and respectful attitude, thought only of securing to the name of king a good portion of royal power. The differences between the two men came to a head in the next campaign, which was to be directed against Persia, now hostile.

This change in Persian policy was the result of the relations of the Spartans to their friend Cyrus at Sardis. This able prince, who made

everything contribute to his ambition of usurping the throne of the Achaemenidae, had been, since 404, assiduously trying to deceive the court of Susa with regard to his plans, and, under various pretexts, collecting a strong army. His main effort was to acquire a strong Greek auxiliary corps; for, free from Persian prejudices, he had learned to value properly the superiority of Greek troops. Disbanded mercenaries, exiles, and other adventurous spirits flocked to his standard. Coming in different bands, under Clearchus the Spartan and other able leaders, they were assembled at Sardis at the end of February, B.C. 401, under the pretext of marching against the mountaineers of Pisidia. Cyrus had, since 402, been in negotiation with the Spartan government. The Spartans were well disposed toward him, but they did not come to an open resolution to furnish generous help. They were only concerned to find out how it might be possible for them, indirectly and in a manner that would least excite suspicion, to support the pretender and retain his favor, and still not embroil themselves with Artaxerxes in case the expedition of Cyrus failed. This tricky policy bore its well-merited fruits. Through the spring and summer of 401 the columns of Cyrus — 100,000 Asiatics and nearly 14,000 Greeks — moved steadily eastward, supported in the passage of the Cilician and Syrian passes by the presence of a Spartan fleet, until in September the numberless hosts of Artaxerxes were met at Cunaxa, forty-one miles northwest of Babylon. The Greeks were victorious; but Cyrus, rashly exposing himself, perished. The Greek generals were invited to the Persian camp to treat for an armistice, and treacherously put to death. Their followers were rescued by the courage, military skill, and inventiveness of the Athenian Xenophon, who had joined the expedition as a volunteer. Born perhaps about 444 (according to a more probable reckoning, 431), a zealous adherent of Socrates, he induced the Greeks by his vigorous eloquence to elect other commanders immediately, and, under his leadership, to take the fearful risk of a retreat northward in the direction of the Black Sea. In spite of all opposition from the Persians and the mountain peoples, they cut their way through the highlands of Armenia, and in February, B.C. 400, still nearly 10,000 strong, reached the Greek Trebizond.

This brilliant campaign produced important results. The experiences of the retreat of the Ten Thousand led to reforms in Greek tactics, which, by rendering the art of war more complicated, gave increased advantages to professional or mercenary soldiers over citizen troops. Above all, the weakness of the Persian empire was made man-

ifest to everyone; and from this time the idea of oriental conquest, so splendidly carried out two generations later by Alexander, became more and more familiar to the Greek mind.

The Spartans were the first to have occasion to make use of the experiences of Clearchus and Xenophon. Their cunning had not deceived Tissaphernes and the Persian court. Tissaphernes, to whose satrapy that of Cyrus and the viceroyship had been added, began in the year 400 B.C. to make war on the Ionian cities, which, after the year 404, had gone over from him to Cyrus. When these cities begged the Spartans for protection, the diplomatic remonstrances of the latter were coldly disregarded. The hostility of the Persians was, in fact, so manifest that the Spartans resolved to anticipate it by declaring war. They thought that they could carry on the conflict with a moderate demand on their own resources, and sent therefore, in the spring of 399, to Ephesus the general Thibron, with only 1000 *neodamodes* (emancipated Helots), 4000 allies, and 300 Attic cavalrymen, former soldiers of the Thirty. Disappointed in the hope of strong re-enforcements from the Ionian cities, Thibron took into his service (March, 399) 6000 of the former mercenaries of Cyrus, who, having traversed the southern shores of the Euxine, and fought a short campaign in Thrace, with more glory than booty, had at last reached the Hellespont. Xenophon delivered the veterans to him at Pergamum, and returned to Athens. In spite of this valuable re-enforcement, the incapable Spartan leader accomplished little. Under his successor, Dercyllidas (late in the summer, 399), matters took an upward turn. This shrewd commander in some measure restored Spartan popularity by conniving at the overthrow of the hated Lysandrian decarchies. Then, availing himself of the enmity between Pharnabazus and Tissaphernes, he made a separate armistice with the latter, and attacked the former so successfully that in a few weeks all Aeolis and the Hellenized Mysian territory far beyond Ida had been wrested from the Persians, and the satrap was forced, at the end of the year 399, to conclude an armistice which allowed the Greeks to go into winter quarters in Bithynia. Now, however, the embittered Pharnabazus stirred up a great war against the Spartans (398). He went to Susa, and recommended most earnestly that a strong fleet be fitted out, and put under command of the Athenian Conon, who, after the battle of Aegospotami, had taken refuge with Evagoras of Salamis (king after 410), the faithful and successful promoter of Hellenic civilization on Cyprus, and had interested him in his plans for the restoration of the naval power of Athens. Artaxerxes

was easily won for Conon's projects; and Pharnabazus received 500 talents to fit out a fleet, the building of which was to be kept secret for the present. When Dercyllidas, in the spring of B.C. 397, by order from Sparta, attacked Tissaphernes in Caria, Pharnabazus went to the aid of the latter at Sardis; and the satraps, with 20,000 foot and 10,000 horse, faced in the valley of the Maeander the 7000 Spartans. Recollecting Cunaxa, however, Tissaphernes avoided a battle, and concluded again a long armistice, of which the Spartans took advantage to send home all their troops except the Cyreans. But at the beginning of the year 396 they were frightened out of their security by certain information about the great naval preparations in Phoenicia and Cyprus. This led to the expedition of Agesilaus and Lysander, to which we have previously referred.

The allies showed little enthusiasm. Still, they furnished 4000 men. Agesilaus took also 30 Spartan citizens, to act as a council, and 2000 *neodamodes*. Wishing to give to the war as much as possible the character of a national struggle against the barbarians, he stopped on the voyage out at Aulis, on the Boeotian coast, in order to offer here, before crossing over to Asia, a stag to Artemis, as Agamemnon had done before the siege of Troy. The Boeotians forcibly disturbed the sacrifice in the most brutal manner. Agesilaus never forgave the Thebans this insult. He landed about the end of April, B.C. 396, at Ephesus. In his military weakness and difficult position, it was not unwelcome that Tissaphernes proposed immediately an armistice of three months, during which he was to persuade the court at Susa to grant the demand of Agesilaus, namely, the freedom of the Asiatic Greeks. The viceroy, of course, did not keep his promise, but hastened to collect new troops from the interior, while Agesilaus trained his army, enlisted the Cyrean mercenaries, and sought to raise money from the Ionic Greeks. Meanwhile he came to a clear understanding with Lysander, whose presumption as well as ascendancy in Asia were alike intolerable to him. With the cunning that he had learned from Lysander himself, Agesilaus so completely undermined the authority of his old patron that the latter sought to cover his humiliation by accepting a post on the Hellespont, whence in the following year he returned to Sparta, thirsting for revenge. Agesilaus found an excellent military substitute in Xenophon. Agesilaus also now developed his own great military talent. He had not, it is true, the genius of Brasidas; and, as a Spartan of the old school, he unfortunately neglected very much the maritime side of the war. Although inferior to Xeno-

phon in tactical and strategical invention, as likewise to Iphicrates and Epaminondas of later times, he produced excellent results with the means at his disposal, and as military organizer, as well as general, won well-deserved renown.

Scarcely had Tissaphernes collected the necessary forces before he proclaimed the armistice at an end. Agesilaus opened the war at once, deceived Tissaphernes as to his immediate object, and hurled himself upon the province of Pharnabazus, which he laid waste close up to

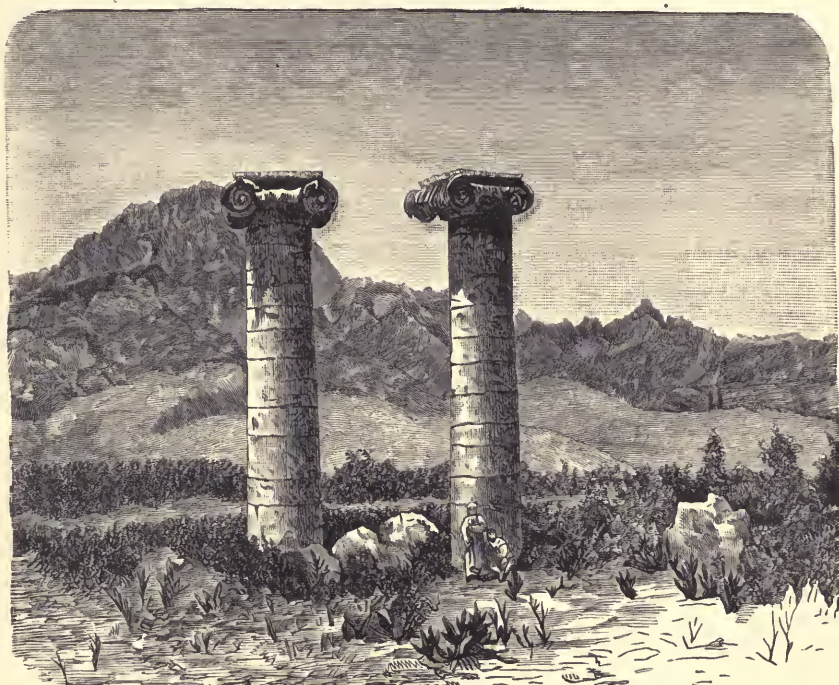

FIG. 161.—Site of Ancient Sardis. (After E. Reclus.)

Daseylum. Strongly re-enforced at Ephesus during the winter, Agesilaus the following spring led his 17,000 men, not, as Tissaphernes feared, against the infantry of the enemy in Caria, but against Sardis (Fig. 161), where, thanks to the tactics of Xenophon, he routed on the Pactolus, under the very eyes of the satrap, the splendid and numerous cavalry of the latter (spring, 395). This defeat, and the hostility of the powerful Parysatis, the mother of Cyrus, led to the deposition and execution of Tissaphernes. Tithraustes, his successor, proposed that Agesilaus should leave Asia, on condition that the Great King should acknowledge the freedom of the Asiatic Greeks, stipulating only that

the latter should pay their ancient tribute to the Persians. As matters then stood, that would have been a very sensible basis for the restoration of a secure and honorable peace; and such prospects were not offered the Greeks again until the time of Alexander the Great. But Agesilaus, to whom the Spartans now committed, contrary to precedent, the conduct of the naval warfare also, declined these proposals, but concluded an armistice for eight months, reserving the right, however, to make war meanwhile on Pharnabazus. A series of diplomatic and military moves now began on both sides, which, contrary to the expectation of most Greek contemporaries, led to the defeat of the Spartan policy. Agesilaus, who invaded the satrapy of Pharnabazus late in the summer of 395, thought it then feasible to attempt a great campaign against the interior provinces of Persia, and to force the king to accept such a peace as the Spartans wished. His purpose was to cause the satraps and tribes west of Armenia to revolt from the Persians, to extort the complete independence of the Asiatic Greeks, and to force back the Persians permanently beyond the Halys.

As Agesilaus, in the spring of B.C. 394, was on the point of setting out from Adramyttium into the interior, he received from the ephors an urgent summons to return home. Half of Greece had taken up arms against Sparta. Tithraustes had made only too good a use of the leisure allowed him by Agesilaus since the summer of 395. He knew that since the dismemberment of Elis the lesser Greek states had been filled with distrust of Sparta. Thebes and Corinth, where the democratic elements had come more to the front, made an alliance, and offered the hand to the Athenians and the Argives. These states, except Athens, went energetically to work when Tithraustes, in the summer of 395, sent the Rhodian Timocrates with fifty talents to Greece to win them to an alliance with Persia and to furnish them means for war. The centre of the new war was Thebes. A feud broke out between Phocis and the Opuntian Locrians late in the summer of 395; and the Thebans, who probably had instigated the quarrel, went to the aid of the latter. At the summons of the former the Spartans interfered. They, and especially Lysander, gladly seized the opportunity for a thorough chastisement of the Thebans; while the Athenian democracy, in spite of their military weakness, concluded an alliance with Thebes. Lysander, who collected an allied army in Phocis, and was to unite at Haliartus with 6000 Peloponnesians whom Pausanias was leading from the Isthmus, advanced into Boeotia; but in an assault upon Haliartus he was killed and his army scattered. Pausanias was not able to recover the ground

that had been lost, and was accordingly banished as 'traitor and coward' (autumn, 395) to Tegea, his young son, Agesipolis I., remaining under guardianship. The Spartans lost during the winter of 395-394 almost everything which they had won in many years beyond the Isthmus. A federal council met on the Isthmus, and called upon all Greeks to revolt from Sparta. Leucas, Ambracia, Acarnania, the Ozolian Locrians, Euboea, the Chalcidian cities, and almost all Thessaly, joined the new alliance. Only Phocis and Orchomenus held to the Spartans. In this desperate state of affairs, Agesilaus had to leave the protection of the Greek cities in Asia to the fleet under his brother-in-law, Pisander.

He himself, with an excellent army of neodamodes, mercenaries, and Asiatic Greeks, crossed the Hellespont at Abydos in July, 394, and advanced along the old route of Xerxes to Thermopylae, against his new Greek enemies. On the march through Thrace and Macedonia he received a welcome message. The allies, through the influence of the Corinthians, who wished to see a war so hurtful to their mercantile interests decided as quickly as possible, had united in a tremendous effort against Sparta's Peloponnesian supremacy. They had assembled at Corinth, in the spring of 394, an army of 20,000 hoplites, besides many horsemen and light troops. To these the Spartans opposed an equally strong Peloponnesian hoplite force, making Sicyon their base of operations, and in the middle of July, 394, severely defeated the allies at the brook Nemea, on the boundary between Sicyon and Corinth (Fig. 162). Though the defeat was not decisive enough to force the coalition to abandon the passes of the Isthmus, it prevented the uprising from spreading to the Peloponnesians, and hindered the allies from checking Agesilaus on his march through northern Greece. Thirty days after his departure from the Hellespont the king crossed (August 14) the Boeotian frontier; and strengthened by re-enforcements from Phocis and Orchomenus, as well as from Sparta, he attacked, on the plain of Coronea, the united forces of the Argives, Corinthians, Athenians, Euboeans, Locrians, Aenianians, and Boeotians. His enemies could not withstand the picked troops of the king, and his and Xenophon's superior tactics. They were beaten with considerable loss, though Agesilaus was severely wounded in a terrible hand-to-hand struggle with the Theban hoplites. He deemed it unwise to attempt to force the Isthmus, but, instead, marched through Phocis and crossed the Corinthian Gulf, thus reaching the Peloponnesus in the autumn of 394 without further opposition. He was greatly discouraged, for just at this time all his work in Asia Minor was irremediably undone.

Conon, in company with Pharnabazus, had opened the maritime war in the summer of 394, and in a sea-fight at Cnidus, early in



FIG. 162. — Grave-relief of Dexileos, who fell in the Corinthian war. (Drawing from a plaster-cast in the Museum at Berlin.)

August, in which the brave but inefficient Pisander lost his life, completely destroyed the Spartan fleet. It was his revenge for Aegospotami. Immediately afterwards Pharnabazus, by Conon's advice, played

the card that never failed of its effect: he declared that he had come to give the Greek cities complete autonomy, without foreign commandants and garrisons! At the end of the year 394 Lacedaemonian authority in the east of the Aegean had been utterly swept away, as if by a hurricane; from Rhodes to the Hellespont the Spartan flag waved only at Sestos and Abydos, where Dercyllidas held out. Pharnabazus and Conon sailed now, in the spring of 393, across the Aegean, where the Cyclades revolted from Sparta. The Persian flag showed itself on the coast of Laconia. Cythera was conquered; and then the expedition turned to the Isthmus of Corinth, and greeted, in May, the federal council of the coalition. Pharnabazus turned over considerable sums of money to the allies, who were now able to put into the field a strong mercenary force. He then returned to Asia, and left Conon to restore Athens. So wonderfully had things changed in Greece, that Persian gold and Boeotian strength now helped to restore the Long Walls of Athens and the fortifications of the Piraeus, which ten years before had been pulled down amid wild rejoicing. The crews of Conon, the Athenians, and the rest of the allies, especially the Boeotians, worked with extraordinary energy. They restored only the two walls between the city and the Piraeus, and were content for the present simply to make the walls impregnable to assault. Not till the following year were the Long Walls entirely finished. But Athens was again ready for action, and could hope now gradually to win back the sovereignty of the sea, which Sparta had taken from her. It was very opportune for Athens that in Sparta, after Lysander's death, the new hatred of the Thebans outweighed everything else. But in a military sense it was well for them and for the Boeotians that the Spartans did not succeed in taking the passes of the Isthmus.¹ Against the latter the coalition arrayed, after 393, a mercenary corps also, which was led by one of the

¹ The Spartans had introduced, apparently during the Peloponnesian war, the new arrangement of the Laconian hoplites, but it was not perfected till the year 404. An important fact now is, that the Spartans and Perioeci are united in the same larger divisions, so that the Spartans, the number of whom capable of bearing arms was already greatly diminished (there were, perhaps, only about 3000 hoplites for field-service), formed only the framework of the larger bodies of troops. Apart from the neodamodes and Helots, there were of the Spartans six morae or regiments, subdivided into lochi or battalions, of an average strength of (at most) 500 men, as it seems; two battalions each for field-service, and two of older warriors for service at home. The lochus was further subdivided into four companies, or pentacostyes, and each of the latter into two enomotiae, or sections. There seems to have been no normal strength prescribed for these divisions; rather, they were levied according to the necessities of the Spartans and Perioeci, so that the strength of the morae and of their subdivisions varied much at different times.

best Athenian officers of the period, the young Iphicrates, the son of a shoemaker, who established his reputation at that time by carrying on the tactical reforms of Xenophon, essentially changing the arms of the troops, and abandoning the old heavy defensive weapons of the citizen hoplites. The new branches of the service, which he developed and trained in an exemplary manner,¹ were partly infantry of the line, having smaller and lighter shields, tin-garnished felt hats, more comfortable boots, but longer spears, partly regular light troops, spearmen or javelin hurlers, provided with small shields, heavily quilted linen jerkin and boots, and armed also with a long dagger. (Fig. 163.)

From B.C. 393 there were two different theatres of war. First the struggle became more and more stubborn in the neighborhood of Corinth, where the Spartans waged bitter warfare with the Corinthians and their allies, especially with the Athenians, for the passes of the Isthmus.



FIG. 163. — Greek Peltast. From a vase-painting. (After v. Stackelberg.)

Then there were feuds on the frontier of Argos, and military struggles for the possession of the Gulf of Corinth. The Spartans directed their attacks with especial violence against the long walls, by which the Corinthians had, after the Attic model, united their city with the western port, Lechaëum, thus closing against their enemies also this best way to the Isthmus. The murder, in the spring of 392, of a hundred Corinthian citizens of Spartan sympathies, which was incited by the Corinthian democracy, but perpetrated by soldiers from Argos, and the union of the cities of Corinth and Argos in one community, was offset by brilliant movements of Agesilaus (391 and 390), whose last success, however, was at once counterbalanced by a victory of Iphicrates. But these struggles led to no decision. This was reached on the second theatre of war, the sea.

The Athenians, since the rebuilding of their fortifications by Conon,

¹ They were generally called peltasts, the name applied hitherto to a kind of Thracian light-armed troops, standing midway between hoplites and bowmen.

had sought to restore also their navy, and to recover a part of their old maritime dominion. That was hard to accomplish. When Persian gold ceased to flow, and home resources failed, while on the other hand, demagogues, like Agyrrius, very inopportunately revived the custom of paying the ecclesiasts and dicasts, as well as furnishing the theatre money, the naval commanders had repeatedly to fall back upon the evil method of forcibly collecting money abroad. Still, they exerted themselves zealously on the old scene of their glory. The occasion of these new maritime conflicts, however, was Sparta, where the conviction prevailed more and more that it would be impossible to continue the war with Persia and at the same time effectually contend against half of Greece. When in the year 392 Tithraustes was replaced at Sardis by Tiribazus, hitherto satrap of Armenia, who still thought it the proper Persian policy to maintain the old connection with Sparta, the Spartan ambassador, Antalcidas, found means to bring Conon into suspicion with Tiribazus as a man who sought the interests not of Persia but of Athens. His influence was the greater because just at that time the relations between Conon's friend, Evagoras of Cyprus, and the Persian court, had begun to assume a hostile character. The satrap was far more pleased still with the new political programme with which Antalcidas thought to ingratiate himself and his state with the Persians. Sparta was willing to give up the Asiatic Greeks completely to the king. Antalcidas recommended, further, that for the rest of the Greek world absolute autonomy, the sovereign independence of all cities, be proclaimed. With this system collapsed not only every combination that might be troublesome to Persia, but also — though the satrap did not see this — the Boeotian league, the alliance of Corinth with Argos, and every prospect of re-establishing the Athenian alliance, while Sparta was not weakened thereby, because her old allies in the Peloponnese were nominally independent. Against these proposals protests were, of course, made by the ambassadors of the Athenians, Thebans, Corinthians, and Argives, who had gone immediately to Sardis, under Conon's guidance, and there had met with Antalcidas. Under these circumstances no peace was effected; but Tiribazus caused Conon to be arrested on the ground of abusing the confidence of the king, and hastened to Susa to win the court for the new policy. But the king was still so embittered against Sparta that he replaced Tiribazus by the energetic Struthas, who again followed the course of Pharnabazus and Tithraustes, and, as it seems, freed Conon from arrest. Conon then betook himself to Cyprus, where he seems to have died, without effecting anything

further for Athens. So the war broke out afresh on the Asiatic side of the Aegean. Thibron, whom the Spartans had sent early in 391 with a considerable force to Ephesus, was defeated and killed by Struthas. But Teleutias, the able half-brother of Agesilaus, won Samos, and with 27 ships conquered 10 triremes, which the Athenians were sending to the support of Evagoras. Under these circumstances the Athenians exerted all their powers, and fitted out forty ships, with which Thrasybulus, in the year 390, had at first considerable success, recovering for Athens Byzantium, Chalcedon, and Lesbos. Finally, however, as he was plundering the cities on the coast of Caria and Pamphylia, he was killed at Aspendus (389). The Athenians now recalled Iphicrates from the Isthmus, by whom the Spartan Anaxibius was badly beaten at Abydos. The Spartans and Aeginetans now opened in turn from Aegina a very annoying privateering war against the Attic ports and coasts, in the course of which one of the future heroes of Athens, the young Chabrias, first displayed his talent. But in the universal exhaustion, even the naval war lagged, until the shrewd diplomacy of the Spartans, who had in B.C. 388 appointed Antalcidas navarch, effected a speedy conclusion.

Artaxerxes wished peace in order that he might more readily enlist Greek mercenaries against the revolted Egyptians; and he disliked the Athenians because of their friendship for Egypt and Cyprus. Antalcidas was, therefore, very cordially received at Susa. His whole political programme was approved, and peace and alliance were concluded between Persia and Sparta. In the spring of 387 Tiribazus and Antalcidas returned to Sardis with the conditions dictated by the king to the Greeks; and Antalcidas, by Persian gold, increased his fleet to 80 ships, to which the Athenians had at the time only 32 to oppose. The closing of the Hellespont, and the cutting off of supplies from the Pontus, so terrified Athens, that she, without hope of further help, determined to yield. On the summons of Tiribazus, a congress of representatives of all the parties to the war assembled in the summer of B.C. 387 at Sardis, where the satrap communicated the terms fixed at Susa, as the new basis of Graeco-Persian international relations. The whole of Asiatic Greece, including the island of Cyprus, was now for the first time proclaimed the property of the Persian crown. Further, the new system of the universal autonomy of all Greek cities beyond the Persian boundaries was now loudly proclaimed. Until after the battle of Chaeronea this was the basis of all treaties of peace. Athens was, indeed, formally released from the military service due to Sparta, as

imposed in 404, and was allowed to retain the islands (apparently lately reconquered) of Lemnos, Imbros, and Scyros, but there was to be no further thought of a new Athenian maritime alliance. Further, the Argives and Corinthians were to give up their new coalition, and Thebes the supremacy over the Boeotians. The king of Persia assumed the guaranty of this treaty, committing to the Spartans the task, as far as Greece was concerned, of directing and watching over the performance of the conditions of the peace. The Greek ambassadors were directed to report to their governments, and then to meet again in Sparta for the final decision as to acceptance or rejection of the conditions. This is the Peace of Antalcidas, which has been always rightly considered one of the most shameful episodes of Hellenic history. The common fault of all the Greeks had brought matters to such a pass, that the same king whose myriads had fled before the phalanxes of Clearchus and Xenophon, before the small army of Agesilaus, whose kingdom was



FIG. 164. — Corona of the tomb erected at Athens in memory of those who fell in the Corinthian War. (Drawing from the plaster cast in the Royal Museum at Berlin.)

hurrying toward dissolution, and whose generals sought more and more eagerly for the help of Greek mercenaries and officers, was now not only undisputed ruler of the Asiatic Greeks, but could speak the final word in all internal questions in Greece proper.

Persia won both glory and profit from the peace, but an even greater share of the practical advantages came to Sparta. Not Artaxerxes, but Agesilaus, became the master of the Hellenes. As an enemy of the Persians he had indignantly held aloof from the negotiations with Susa; but he recognized at once how easy the execution of the terms of this treaty would make it to re-establish the supremacy of Sparta on new foundations. The course for Sparta now was to foster the spirit of home rule and of state sovereignty, and to declare every federal relation a breach of the treaty. Sparta could thus break up every strong power which might become in any way dangerous to her. The warlike king now took the direction of the foreign policy completely into his own hands.

The opponents of Sparta did not dare to reject the peace of Antalcidas. When their ambassadors appeared in Sparta, in the summer of 387, to ratify the treaty, Agesilaus showed them at once how he understood the future, in that he most bluntly defeated the Theban purpose of taking the oath for all the Boeotians. Orchomenus was recognized as an independent state, and Plataea restored. Before his threats the Argives now retired from Corinth. Thus the so-called Corinthian War ended (Fig. 164). The two new allies, Persia and Sparta, held the field alone.

CHAPTER XIV.

CULMINATION AND SPEEDY DECLINE OF THE SPARTAN POWER.—
RISE OF THEBES.—THE SECOND ATHENIAN CONFEDERATION.

IN Sparta the authority of Agesilaus was practically undisputed. All who had in any way opposed the interests of Sparta had now to tremble. The new policy of Sparta was, in the name of the autonomy of all the smaller communities in Greece, to take revenge, first in the Peloponnese, on such states as had in any way transgressed against Sparta or her adherents within their walls. With this was connected a shameful indifference to natural right, and toward all foreign rights and interests. To the indignation of the Hellenes, the citizens of Mantinea were, after a long siege (385–384), forced to break down their walls, and to disperse into several villages under aristocratic magistrates. This was the most flagrant misuse of the peace of Antalcidas.

For Greek politics in general it was far more hurtful still that in the distant north the development of a promising new combination was checked. Since B.C. 393 the powerful state of Olynthus, in alliance with Potidaea, had greatly increased its power at the expense of Macedonia, forced most Chalcidian cities to recognize its hegemony, and had lately (B.C. 384) made an alliance also with Athens and Thebes. At the request of Amyntas II., king of Macedon, and of the cities Apollonia and Acanthus (B.C. 383), the Spartans interposed, and began a tedious war, which ended early in 379 in a complete victory for them. The Olynthian alliance was dissolved, and the different cities forced to enter into an alliance with Sparta. Thus was overthrown a power that might have served to balance the growing strength of Macedon. A short time before, Spartan policy had won two other great successes. As the polemarch Phoebeidas, in the summer of 383, was leading strong re-enforcements to Chalcidice, he seized the opportunity, in agreement with Leontiades, the leader of the oligarchy at Thebes, to surprise the Cadmea, and thus not only to establish the rule of the oligarchy in Thebes, but to bring the city at the same time under the supremacy of Lacedaemon. Agesilaus was able to have this illegal measure approved

by the Spartan government. Phoebidas was recalled, it is true, but the Cadmea was permanently garrisoned.

Still worse was the fate of the city of Phlius, which had adopted a democratic organization during the last war. Tedious disputes between the commons here and the numerous aristocracy were the cause of Agesilaus's interference (381). When the famished city surrendered to the Spartans, after a siege of many months, among other hard terms, a garrison was imposed upon it that served as a support for the strictly oligarchic constitution, which was restored.

Phlius surrendered about the same time with the fall of Olynthus, early in B.C. 379. Sparta was now at the highest point of her power. Excepting Argos and Athens, Sparta under Agesilaus held undisputed sway from the Eurotas to Chalcidice. Democracy had, as it seemed, played out its part in Greece. As in Laconia itself the oligarchy had closely allied itself with the regal power, so beyond the Laconian borders Spartan supremacy depended partly on the oligarchy, partly on kings and tyrants. The Great King at Susa, the king of Macedonia, the chief of the Epirote Molossians, and the tyrant Dionysius of Syracuse, were allies of the Spartans, who now, having once for all given up Asia, seemed to have established their supremacy over Greece more firmly and securely than ever before. It was, however, an illusion. Even though considerable elements in the Greek world rejoiced in the new power of Sparta, neither Sparta nor Agesilaus was able to conciliate the vast democratic majority of the Greeks. Spartan rule had no foundation, except bare military supremacy. There were no material and mercantile advantages; there was, since the alliance of the Spartans with Persia, and since the sacrifice of the Asiatic Greeks, no longer the shadow of a political idea, for the sake of which the Greeks could for a moment be content with their subjection to the ephors and harmosts, and to the oligarchs in their own cities. The shrewd politicians on the Eurotas did not suspect how deep-rooted in all Greece was the hatred of the democrats for their rule; the same year in which Olynthus yielded to Sparta was to be the beginning of the decline of their own power.

The first blow against their supremacy came from the city which had been most deeply humbled, Thebes. The severely oppressed democratic party of this state counted just then in its ranks a number of able men, such as Thebes did not possess before or after. These, the majority of whom were high-minded men of noble families, bore with deep indignation the double yoke of their native oligarchy and of the Spar-

tan commandants. In Thebes, however, nothing could be attempted at present, and the leaders of the suppressed party could only quietly watch their opportunity. Among these Epaminondas (born about 418 B.C.) was the most gifted, and at the same time morally the purest of all the statesman and generals of this epoch in Greek history, a man of the broadest culture, and thoroughly saturated with the idealism of the Pythagorean doctrines, which were already completely detached from their connection with oligarchic theories. Theban exiles, many in number, impatiently longed for the day when a decisive blow might be struck. The main body of these fugitives had found refuge in Attica, where they received active sympathy from all parties. Their leader was a younger friend of Epaminondas, the rich and brilliant Pelopidas, son of an old patrician family, of high talent as a soldier and statesman, an aspiring and ardent nature, long devoted to the cause of the commons in the sense of the ideal school of Epaminondas, which was in sharp contrast to the brutal and coarse-grained character of the average Boeotian democrat. He was eager to become the Theban *Thrasylulus*. Communication was maintained with friends in Thebes, who had skilfully developed the art of preparing conspiracies, allaying the mistrust of the oligarchical leaders, and insinuating themselves into the confidence of the latter, and even obtaining office under the government. The conspirators at Thebes and the fugitives at Athens attempted a bold stroke in December, 379, since at that season a rapid advance of the Spartans into Boeotia was hardly to be expected. One winter night, amid wind and snow, Pelopidas and a small troop of fugitives slipped into Thebes, where their associates first put to the sword a part of the oligarchic leaders, who had been invited to a banquet. Pelopidas and a few attendants slew Leontiades in his own house after a fierce struggle. The captives were then released, and the people of Thebes called upon to strike for freedom. The next morning the commons appointed Pelopidas, Melon, and Charon as Boeotarchs, and applied themselves with all their might to the siege of the Cadmea, in which they were joined by many Athenian volunteers. The 1500 Peloponnesians in the Cadmea did not hold out long. Surprised, and therefore poorly provisioned, and burdened with oligarchic fugitives from the city, the harmosts lost their senses, and capitulated after a short time on condition of being allowed to depart unmolested.

The question now was, Could the Thebans — who immediately set to work to weld the league of Boeotian cities into a well-organized state under their leadership — maintain themselves? Sparta determined

to crush the revolt in Boeotia as quickly as possible. The Spartans sent, in B.C. 378, a Peloponnesian army under King Cleombrotus I. (king since 380), to Boeotia, who, on account of the unfavorable season of the year and his own military inexperience, did nothing except intimidate the Athenians, whose sympathies with the Theban revolution were well known. When he withdrew from Boeotia, at the end of three weeks, he left behind the harmost Sphodrias with a strong force and with money for the enlistment of mercenaries, so as to keep the Thebans at Thespieae constantly annoyed. The situation of Pelopidas and his friends was therefore not an easy one. The Spartans, by a piece of folly, now turned against themselves the full energy of the Athenians. Sphodrias, who did not doubt that a successful blow against Athens would be approved at Sparta, learned that it would be possible, by a *coup de main*, to surprise the Piraeus; and in the spring of 378 made this bold attempt. He failed, and was mad enough to plunder several Attic villages on his retreat. He was removed from his command; but when he was acquitted before the Gerusia in Sparta through the influence of Agesilaus, the storm broke forth in Athens.

An alliance offensive and defensive was soon made between Athens and Thebes, and every energy exerted to form a new maritime alliance. The most prominent statesmen of Athens now united (378–377) in the patriotic effort to win back a part of their former prestige. It was necessary to raise by direct taxes the means to collect a fleet of 200 triremes and a considerable army. A general assessment was made, and a progressive income-tax introduced. Every one who had an income of more than 100 minas (about \$1800) was now compelled to pay a full fifth to the state. The remainder of the citizens (except the poorer ones, perhaps those whose property was assessed at less than 25 minas, or about \$450) were divided into 20 symmories or tax-unions (with 1200 citizens in all), under the oversight of the strategi, each representing a like amount of taxable property. The 300 richest men, 15 from each symmory, advanced the tax to the state, and it was refunded to them by the remaining members of the symmory. The strong feeling of the Greeks against Sparta, as well as the shrewdness and moderation of the Athenians, promoted the growth of the new alliance, the task prescribed to which was to secure the freedom and independence of the Greeks against the Lacedaemonians. Under the influence of Callistratus of Aphidnae (nephew of Agyrrhius) the greatest public orator of this period, Athens established the principle that the autonomy of the allies should not be threatened, and should

even be restricted only in so far as federal interests required. Athens renounced all claim to new cleruchies, and proposed to be only the leading power among free communities. In accordance with the terms of the federal constitution agreed upon with Chios, Mytilene, Rhodes, Byzantium and other states, the federal tax was no longer called by the hated name of *phoros* or 'tribute,' but *syntaxeis*, or 'contributions.' All Hellenic or non-Hellenic communities could be members, provided they were not under Persian supremacy; all allies were to be represented in the Synedrion, or Federal Council, in which every state, without regard to size, had one vote. The Synedrion itself was to be an advisory council to the Athenian federal administration, and the Athenian Ecclesia was to have the final decision of all matters laid before it by the Athenian Boulé and the Synedrion. Athens had the right to admit new members, to exclude those that were negligent in the performance of federal duties, and finally to send and receive ambassadors for the alliance. At the beginning of the year 377 the Athenians called upon all the Hellenes to join the new confederation; and, besides Thebes, a number of Greek coast and insular cities, and especially Euboea and many of the Cyclades, at once gave in their adherence. The brave Chabrias, Conon's brilliant son Timotheus, and Callistratus were the first leaders of the new allied fleet.

The Spartans for a time looked quietly on the new naval growth of the Athenians, for the embittered Agesilaus was above everything intent upon overthrowing Thebes again. The whole land force was now reorganized, the territory of the Lacedaemonian alliance being divided into ten districts, and the army into ten corps. Still, fortune refused to favor the aged king. Two expeditions which he himself led against Boeotia, in 378 and 377, and a third under Cleombrotus, in 376, accomplished nothing. The allies of the Spartans now insisted upon opening the war by sea especially and against Athens, and fitted out 60 triremes, which, under the Spartan navarch Pollis, blockaded the Piraeus. But the Athenians fitted out 83 ships, with which Chabrias repelled the blockaders, and then won, September, B.C. 376, in the strait between Naxos and Paros, a brilliant and decisive victory over the Peloponnesians, in which the young Phocion, destined to play an important part in later history, served as sub-commander. It was the last day of Spartan supremacy on the sea, and the first day of the new Athenian naval supremacy. In order to take full advantage of their victory, the Athenians fitted out two new fleets. With one Chabrias sailed eastward, at the beginning of the year 375, in order to extend

the alliance in the northern archipelago and on the Thracian coast, where he relieved Abdera from an incursion of the barbarous Triballi. Still greater successes were won by his colleague Timotheus (born not long before 405 B.C.), on the west side of Greece. He was attended on his expeditions by the orator Isocrates, and with 50 ships laid waste the Laconian coast, reached the Ionian Sea, and largely by his mildness won for the alliance the islands of Cephallenia and Coreyra, the cities of Acarnania, and the Molossian chieftains. These successes of the Athenians, and an appeal for help from Leucas and Ambracia, induced the Lacedaemonians to fit out 55 ships, which, under the Spartan admiral Nicolochus, met the Athenians at the Acarnanian town of Alyzia, near Leucas. In June, B.C. 375, a great battle was fought, in which Timotheus won a brilliant victory.

Spartan power in northern Greece was also threatened by the hostility of Jason of Pherae, the *tagus* or generalissimo of Thessaly, a ruler of great ability, and the commander of 50,000 soldiers. Thus the Spartans were driven back beyond Oeta; and under such circumstances it was agreeable to them that the Athenians began to be weary of the expensive war, and in 374 to negotiate for peace. On the basis of the peace of Antalcidas, it was agreed that all garrisons should be withdrawn from foreign territory, Sparta recognized as leading power of the Peloponnesian alliance, and Athens of a maritime league. Thebes also, as it seems, recognized the peace. But it was scarcely concluded before new difficulties, connected with internal feuds on the island of Zacynthus, once more led to war between the Athenians and Spartans (373), a war that resolved itself finally into a struggle for the possession of Coreyra, wherein Athens finally prevailed. The Spartans now sought, with the help of the Persians, to bring about a general peace. The wish was readily met by the court at Susa, which was again anxious to enlist Greek mercenaries against Egypt. Even the Athenians were glad to let their arms rest, especially as they were jealous of the rising power of Thebes, which had recently once more destroyed Plataea, and driven its citizens into Attica, and taken Tanagra and Thespieae besides.

As Thebes made no opposition, a great pan-Hellenic Congress met in Sparta in June, B.C. 371, at which Persia and Macedonia were also represented, to conclude a general treaty. After long and interesting negotiations, the peace of 387 was re-established. The autonomy of the cities was to be realized in a sensible way. Sparta promised to give up her policy of expansion, and to recall her harmosts and garri-

sons everywhere. The duty was not assigned to any single state to see that the terms of the treaty were carried out; but every state was at liberty, according as it thought best, to go to the help of any community that was injured. With this last condition Agesilaus hoped to be able at last to isolate and crush Thebes. On June 16, B.C. 371, the treaty was signed and ratified by Persia, Sparta (for her Peloponnesian allies), and Athens (and with her the individual allies of the Athenians). But on the next day the Boeotarch Epaminondas, the brilliant representative of Thebes, positively refused to allow the Boeotian cities to sign separately, and demanded that Thebes should take oath for all. This meant the recognition of the new position of Thebes in Boeotia, and made at the last moment a breach between Thebes and Sparta.

Agesilaus now exerted himself with fierce energy for the last war, as he hoped, against Thebes. Cleombrotus, who was at the time guarding Phocis with four Lacedaemonian morae and various contingents of the allies, received strong re-enforcements from Sparta, and was ordered, with further re-enforcements from Phocis and Heraclea, to invade Boeotia. Unfortunately, Agesilaus was aware neither of the military capacity of the rejuvenated Boeotian people, nor that in Epaminondas the Spartans had a formidable opponent. Hitherto his people had known him as a statesman of ideal moral purity, the Aristides and Pericles of Thebes. He now appeared as the discoverer of a new kind of military tactics. His system of the so-called 'oblique order,' substantially an extension of the reforms of Xenophon and Iphicrates, consisted in a division of the army into a defensive and an offensive wing. The former was to hold itself in an attitude of observation only, and carry on the conflict with the enemy, if possible, only by means of cavalry and light troops; the latter was made as strong and efficient as possible, and with it the opposing hostile wing was to be assaulted and crushed. Epaminondas now tested this system on the field of battle.

Cleombrotus advanced with 10,000 infantry (4000 being Lacedaemonians), and 1000 cavalry from Phocis, by way of Thisbae and Creusis, to the hill country between Thespieae and the ruins of Plataea, where he was met at Leuctra by 6000 Boeotians, under Epaminondas and Pelopidas, July 6, 371. The Spartans arranged their army in their old order,—the infantry twelve deep, the Lacedaemonians on the right, the allies on the left wing. Thus the troops descended into the plain before their camp, and the cavalry and peltasts began to manoeuvre before the line of hoplites. Epaminondas sent against them his excel-

lent cavalry; and these hurled back the hostile cavalry upon the centre of the army of Cleombrotus, so that for the time only the wings of the latter could advance. Then the plan of the Theban general became manifest. He had arranged his right wing in line after the old manner. This was to hold back, not following the assaulting movement of the left. The left, or offensive wing, was drawn up in the form of a thick mass of hoplites, fifty deep, including the picked 'Sacred Band' of three hundred, under Pelopidas. As Epaminondas advanced at double-quick against the right wing, which was under Cleombrotus, the king sought to outflank him. Thereupon Pelopidas broke away from the column with his three hundred, and threatened the right wing and rear of the Spartans. At this critical moment, as Cleombrotus was endeavoring to extricate his wing from this situation, the full weight of the Theban storming column fell upon his front, and a murderous hand-to-hand conflict between Spartans and Thebans followed. Not until the young king and many prominent Spartans had fallen, did the Thebans succeed in breaking the ranks of their enemies. Then, however, all gave way, and fled for refuge to the camp near by. It was a decisive defeat, such as the Spartans had never experienced in open field, and their losses were ruinous: of 700 Spartan citizens in the army, 400 had fallen, besides 1000 Lacedaemonian hoplites. For the present the sound of arms was hushed. But while Epaminondas was watching the hostile camp, and the Spartan government was directing the whole fighting force of Laconia in all haste northward, under the command of Archidamus, son of Agesilaus, Jason of Thessaly, to whom it was important that Thebes should not become too powerful, arranged an armistice, under which the beaten army could march away to Megaris, whence Archidamus led it back home.

The catastrophe of Leuctra was the beginning of the fall of the Spartan power. The immediate fear of the Spartans, who numbered now not much more than 2000 Dorian citizens, was a war of revenge from the Thebans. But this was not to take place for some time; for Epaminondas was forced to great caution by the policy of the Thessalians, as well as of the Athenians, and proposed first to establish firmly the hegemony of Thebes in Middle Greece. Jason was an object of the greatest suspicion to the Thebans, because he secured at that time the possession of Thermopylae, and was making great preparations by land and sea. In the summer of 370 his plans assumed a threatening shape. But just then he was murdered by some young men from motives of private revenge; and Thessaly, where for the present two

brothers of the prince divided authority, ceased to be dangerous to Thebes. More troublesome to them was the diplomacy of the Athenians after the battle of Leuctra, who, following the lead of Callistratus, and working against Thebes as well as against Sparta, invited representatives of all the states that were inclined to ratify once more the peace lately concluded to meet for negotiations in their city, in the spring of B.C. 370. On this basis they operated very successfully against the Theban plans for winning the hegemony, and shattered at the same time the ruins of Sparta's Peloponnesian power; for, with the exception of the Eleans, ambassadors of the Peloponnesians united with Athens in an agreement to repel with united forces every attack upon the independence of any one of the states that had become a party to the peace. But the rough hand of the Boeotians, and of the new elements springing up in the Peloponnese itself, soon tore to pieces the nice web of diplomacy. The Thebans had, since Leuctra, completely subjugated Boeotia. Then the energetic Epaminondas extended without opposition the hegemony of Thebes over the whole of central Greece. Even the Euboeans recognized the supremacy of Thebes, into whose hands, after Jason's death, Thermopylae also fell. In the second half of the year 370 Thebes was already at the head of an immense military force, which was to be directed against Laconia. After 370 and 369 circumstances in Thessaly and Macedonia repeatedly called for the interference of the Thebans. It would have been of great benefit to the Hellenes had Epaminondas been content with hurling the Spartans back upon the Peloponnese, and with the supremacy over the countries from Acarnania to the east coast of Euboea, so as to direct now the strength of Thebes to the north of Greece. But entirely controlled by the thought that the unity of Boeotia and the freedom of Greece could only be secured by completely crushing Sparta, it seemed to him imperative to extend the Boeotian power to the Messenian Gulf. An overstraining of Boeotian resources resulted. First, however, the Spartan power, even in the Peloponnese, received a deadly shock, especially through the plan of Epaminondas to restore Messenia to the number of independent Greek states. The immediate occasion of his decisive expedition to the south of the Peloponnese was an appeal for help from the Arcadian city of Mantinea.

Beginning with the second half of the year 371, after the Lacedaemonian garrisons had withdrawn to Sparta, in accordance with the terms of the treaty, terrible uprisings of the hitherto repressed democratic factions occurred at many places in the Peloponnese. Scarcely

surpassing other scenes of horror, was the *scytalismus* at Argos, when 1200 of the wealthiest citizens were clubbed to death by the rabble.

The Mantineans first rose (371) in the most defiant manner against Sparta, and began to build a wall for a new general city, which became the starting-point for a mighty movement for Arcadian unity. In the district of Arcadia, hitherto significant principally as the home of brave allies of Sparta and of mercenaries, there was now a democratic party, which wished complete separation from Sparta and the creation of a strong and united Arcadian state. Mantinea and Tegea were the strongholds of this party, which was manifestly directed by Epaminondas, and stood in direct opposition to the Spartophile patrician families of Tegea and Orchomenus. The most conspicuous of its leaders was Lycomedes of Mantinea. In the autumn of 371 it was agreed to create a general government, a legislative body, and an allied army for Arcadia. The so-called Ten Thousand (representatives from all the Arcadian cities) were to meet at definite times in the metropolis, and to choose the magistrates, who were to reside in the capital, and be supported by a standing army of 5000 men (the so-called Epariti). The new capital, Megalopolis, was to be built in the fertile plain of southern Arcadia, a league from the Alpheus, on the river Helisson, not far from the northern border of the valley of the Eurotas, as a bulwark against Sparta. In the year 370 an Arcadian synod met at Tegea, where this plan was approved, and a commission of ten men chosen, who now, apparently under the protection of a thousand Thebans under Pammenes, were to inaugurate the building of the new city, the circular wall of which was to be about six miles in length. But great difficulties were encountered among the Arcadians themselves, not only in supplying the city with inhabitants, but in carrying out the remaining decrees. Many peasant communities could be induced only with extreme difficulty, sometimes only by force, to give up their country comfort or their mountain homes, and remove to the new city. Likewise several towns where Spartan and aristocratic sentiments predominated, such as Orchomenus and Heraea, opposed any connection with the new enterprise, and armed themselves against their countrymen. Fierce and bloody scenes were seen in Tegea, where, in the summer of 370, the insurrection of the strong aristocratic party, under Stasippus, and of many other citizens who did not wish to give up the autonomy of their city, was crushed in open street conflict by the opposite party, and their friends from Mantinea and about 600 prisoners were murdered.

Under such circumstances it was inevitable that the Spartans

should take up arms again. Agesilaus, late in the summer of 370, invaded the region about Tegea, and laid waste the neighborhood of Mantinea. The Arcadians sent to Thebes for assistance, and meantime avoided a battle. But upon Laconia a fearful storm was soon to burst, whose perceptible advance probably induced the king, late in the autumn, to return in all haste to Sparta. The Thebans, Epaminondas and Pelopidas at their head, were finally in a position, military and political, to open the war of revenge in grand style against Laconia. They crossed the Isthmus in December, 370, 6000 strong, besides numerous allies from central Greece, and united at Mantinea with the contingents of the Arcadians, Argives, and Eleans. Urged by these to invade Laconia, even at this late season, they were still more encouraged to the step by the deserters, who came in crowds from Laconia, bringing information that the Perioeci were ready to revolt from Sparta, that the frontier passes were weakly guarded, and that the insurrection in Messenia was already in full blaze. Hope of plunder and of revenge gathered in southeastern Arcadia a mighty host, who proposed to punish the Spartans for the oppression and cruelties of centuries. Epaminondas and Pelopidas found themselves at Tegea at the head of 70,000 men, 40,000 of these being hoplites. In the last days of the year 370 they advanced in four columns from Tegea across the Laconian border. They moved down the valley of the Eurotas, laying waste the country as they went, while Helots and Perioeci came over to them in great numbers. Agesilaus, whose anti-Theban policy had almost proved the ruin of his country, was now her saviour. Avoiding a battle, and abandoning the open country, he gathered all his forces within the unwallied town of Sparta, where he presented so formidable a front that Epaminondas, after an unsuccessful skirmish, recoiled. The Thebans wasted the valley of the Eurotas to the sea, destroyed the naval arsenals at Gythium, and then withdrew into Arcadia, where they assisted at the building of Megalopolis. Hence they presently made another forward movement, this time into Messenia, where, with the zealous co-operation of the Argives and Arcadians, Epaminondas founded Messene (March, 369), as the central point for the restored Messenian people, who now flocked thither from all parts of Greece. Escaped Helots and others strengthened the new state. The capital city, Messene, which had the old renowned Ithome as acropolis, rose at its western base behind walls of imposing strength, and was long protected by a Boeotian garrison; not before the spring of 365 did the Thebans return to central Greece. For the first time since Cimon's

fall the Athenians had taken up arms for the rescue of Sparta. They had despatched a corps toward the Peloponnese under the command of Iphicrates. But when the great army of Epaminondas approached the Isthmus, Iphicrates, who knew that Sparta was now safe, did not seriously oppose their passage.

In Epaminondas all must admire a statesman who never did anything by halves, and who carried out all that he undertook with a high purpose, with practical tact, and irresistible energy. On his creations, however, rested no blessing for Greece. Messenia never rose to a higher conception of her mission as a Hellenic state than uncompromising hatred toward Sparta. Megalopolis rose to no eminence until long after the downfall of Greek freedom; Sparta was humiliated and infuriated, but not crushed. There was no security for the new order of things, except in the power of Thebes, which, as the event proved, was in great part dependent on the single life of Epaminondas.

The overtures of Sparta were scornfully rejected by Persia, as Artaxerxes believed that she was ruined forever. From Dionysius I., of Syracuse, however, valuable re-enforcements were received. The Lacedaemonians, with these troops, their Peloponnesian allies, and the Athenians, 20,000 men in all, sought by guarding the Isthmus to break the connection between the Thebans and their new *protégés* in the peninsula. Epaminondas, advancing in the summer of 369, with only 7,000 foot and 600 horse, against the Peloponnese, stormed one of the passes, Lechaëum as it seems, and broke through the lines of the enemy; but he won this time only one considerable advantage, namely, the possession of Sicyon, which secured to the Thebans, at all events, a safe passage into the interior of the Peloponnese. The results of this campaign did not satisfy the Thebans, urged on as they were by the radical element in their midst and Epaminondas was deprived of the Boeotarchy. This gave the bold Lycomedes of Mantinea opportunity to stimulate by his demagoguery the self-confidence of the Arcadians to an extraordinary degree. In the year 368 this warlike and plunder-hungry mountain people made in various directions strokes as bold as they were successful. But success at last visited the Spartans under Agesilaus's able son, Archidamus. Spartans, mercenaries, and Celtic auxiliaries from Syracuse, inflicted a great defeat upon the combined Arcadians and Argives at Midea, in the southernmost part of Arcadia (summer, 368). Not a single one of the Spartans fell in this fight, which they therefore called the 'Tearless Battle.' Still Sparta experienced new and painful humiliations. The next winter Pelopidas

went as ambassador to Susa, and won the Persians completely for the policy of Thebes. Boeotia was recognized as the leading power in Greece, the relations established since 370, especially the independence of Messenia, were to stand, and Athens received the humiliating command to dismantle her fleet, and draw it up on land.

Thebes made now the discovery that the decrees of the Great King were heeded in Greece only when the power favored by him had itself the means to retouch with Grecian colors the picture outlined at the Persian court. The attempt of the Thebans to have their hegemony, thus sanctioned by Persia, formally recognized by all Greece, failed. To say nothing of Athens and Sparta, the Arcadians especially opposed it in the most defiant manner. Not until the death of Lycomedes (366) did the commotions in the interior of the Peloponnese begin in some measure to subside.

In the meantime much of the strength of Thebes was employed in northern Greece, where in B.C. 369 the encroachments of Alexander of Pherae compelled the other Thessalian nobles to appeal to Thebes for aid. An expedition under Pelopidas settled the affairs of Thessaly, and also of Macedonia, where the son of King Amyntas, Philip, afterwards so celebrated, was taken as a hostage to Thebes. Pelopidas was, however, next year treacherously captured by Alexander at Pharsalus. Epaminondas ultimately compelled his restoration to freedom; but Pelopidas remembered the insult, and was only too glad to be again summoned (in 364) to act against the tyrant of Pherae. With a vastly inferior force he met Alexander at Cynoscephalae. His impetuosity proved fatal to himself. Like Cyrus at Cunaxa, he was slain while striving with a handful of followers to reach and cut down the person of the opposing leader. But the Thebans won a brilliant victory; and Alexander, completely humbled, was compelled to confine himself to the immediate domain of Pherae, and to enroll himself as a subject ally of Thebes.

Jealousy of the maritime progress of the Athenians, who, under Timotheus, had since 368 recovered Samos, Sestos, Methone, Pydna, Potidaea, and other points, led to an enterprise neither justified by the demands of the time nor consonant with the character of the Boeotians. A fleet of 100 triremes was equipped, and sent into the Aegean in 364, under the command of Epaminondas. This, the first and last expedition of the Thebans by sea, led to no result save the freeing of Byzantium from Athenian supremacy. When Epaminondas returned, he was greeted by the news that the radical element at Thebes had taken advantage of his absence to destroy, on a trivial pretext, the ancient

Boeotian city of Orchomenus, to murder the men, and sell the women and children into slavery.

The Peloponnese now required all the care of Epaminondas. Since 365 a breach had occurred between the Arcadians and the Eleans, the latter of whom were displeased at the annexation of Triphylia to Arcadia, and seriously feared that the Arcadian democracy, in their greed for the Olympic temple treasures, would seize also the territory of Elis. Thus resulted a bitter feud, in which the Eleans were supported by the Achaeans and the Spartans, and in 364 an unheard-of scandal: in place of the ancient sacred peace-festival, the rivals fought a bloody battle on the very soil of the Olympic sanctuaries, in which the Arcadians were victorious. But when the Arcadian central government at Megalopolis seized the Olympian treasures, in order to pay their troops, there was such indignation, even in Arcadia — beginning with Mantinea — against the central government, that in 363 the Arcadian union was in effect dissolved. Mantinea was the stay of the aristocratic and separatist elements, while Tegea, under the protection of a Boeotian garrison, was the bulwark of the democratic elements that favored unity. From this state of affairs resulted the last great Boeotian-Arcadian war. The central government begged help from Thebes, while the Ten Thousand, a majority of whom were now aristocratic, forbade the Thebans to interfere, and proposed to make peace with the Eleans, restoring to them the protectorate over Olympia. But when a meeting was held at Tegea for the purpose, it seems, of ratifying by oath the treaty of peace with Elis, and celebrating the formal reconciliation of the quarrelling Arcadian parties, the over-hasty chiefs of the democratic-centralizing party fancied, apparently, that they had detected a plot of their opponents to stir up in Tegea an oligarchic revolution, and play the city into the hands of the Spartans. They therefore persuaded the Theban commandant to arrest their opponents *en masse* on the evening of the festival (April, 362). On the bitter protest of the Mantineans, the Theban officer released his prisoners; but the avalanche was already in motion. The insulted Arcadian party made bitter complaints at Thebes, and demanded the death of the commandant as an atonement. But Epaminondas, who was convinced that this officer had really forestalled treachery, gave a curt reply, and proposed now to leave the question of the future to be settled by arms. The majority of the Arcadians in favor of local independence at once made alliances with the Eleans, Achaeans, and Spartans, and begged the Athenians also for help. Epaminondas, on the other side, called

out the Boeotians, Euboeans, Thessalians, Locrians, Malians, and Aeni-
anians *en masse*. Only the Phocians refused to furnish him troops.
While the home-rule Arcadians, Eleans, and Achaeans assembled at
Mantineia, Epaminondas advanced to Tegea, where he was joined by
the Arcadians of opposite view, the Messenians, and the Argives.

After a vain attempt to draw his opponents at Mantineia into a
battle, the bold leader, on hearing that the aged Agesilaus, with the
whole force of the Peloponnesians, was marching northward, and had
already reached Pellene in the upper valley of the Eurotas, thought by
a sudden advance to surprise and destroy Sparta, and with 15,000 men
made, in a June night, a forced march thither from Tegea. But when
at daybreak he crossed the Eurotas to the north of the city, the Spartan
red-cloaks were already visible before him. A deserter had informed
Agesilaus of the danger, and made it possible for the old king to send
messengers on horseback to Sparta, and then to return himself with a
part of his troops before the Thebans could reach the Eurotas. When
Epaminondas forced his way into the city at nine o'clock in the
morning, he found himself involved straightway in a murderous street
conflict, in which the whole population, well directed by Agesilaus
and Archidamus, from housetop and barricade, fought with fearful bit-
terness, and finally drove from the city the Boeotians and their allies,
who had advanced as far as the main Agora at the eastern base of the
Acropolis. Epaminondas returned the following night to Tegea, and
sent his cavalry to make a sudden attack on Mantineia, which he sup-
posed to be ungarrisoned. But here, too, he was unsuccessful; for
6000 Athenians, under Hegesilaus, had just arrived, and their cavalry
in hot conflict repulsed the Thessalian and Boeotian horse. The
decision was to be made in a great battle. The great Theban had
30,000 hoplites and 3000 horse, to whom the enemy opposed 20,000
foot and 2000 horse. Epaminondas marched somewhat northwestward
above Mantineia, and began the battle with his usual masterly skill
(July 3, 362). A strong cavalry attack from his left wing, which
routed the Lacedaemonian cavalry, masked the advance of his infantry.
The right wing and the centre formed again the defensive part of his
army. The left wing, Arcadians and Boeotians, was arranged in the
form of deep assaulting columns. His enemies scarcely had time
to draw up in line in their old fashion, — across the plain with their
backs to the city, Mantineans and Arcadians on the right, then the
Lacedaemonians, Eleans, and Achaeans; on the left the Athenians.
The fearful shock of the Theban assaulting column shattered the right

wing of the enemy, and tore apart the Arcadians and Lacedaemonians. The battle was practically won for Thebes, when Epaminondas received a fatal wound; the prize of this victory had slipped forever from the hands of the Thebans. The dying hero advised his friends to make immediate peace. The long struggle for the hegemony in Hellas was now at an end. Sparta had lost it forever. Thebes was not able to maintain it. The Hellenic leaders concluded at once (summer, 362), on the basis of the present state of possession and of the independence of Messenia, a universal peace, which only the Spartans, on account of their Messenian claims, refused to sign; though even they observed it.

The glory of the great period of Thebes, from Leuctra to Mantinea, rested long upon the battlements of the Cadmea; and the state exercised for the present a perceptible influence in central Greece, and northwards as far as Pella. The Athenians, on the contrary, found just now many annoyances in their maritime domain; in the summer of 361, the fleet of Alexander of Pherae (who had now turned to piracy) surprised and conquered the Athenian fleet at Peparethus, and afterwards forced its way into the Piraeus, and plundered the bazars on the shore. This disaster overthrew the influence of Callistratus, who for some time previous had guided the foreign policy of the state. He was supplanted by Aristophon, who represented a more pronounced shade of the democracy. Foreign relations assumed a more favorable form. Alexander of Pherae was murdered by his wife's brothers in 359. In Thrace the hostile chieftain Coyts fell likewise in the same year, by a murderer's hand; and his son Cersobleptes concluded, at the beginning of the year 357, a treaty with the general Chares, who was personally favored by Aristophon, by which the Thracian Chersonese, except Cardia, was recognized as belonging to the Athenians. The latter, indeed, did not yet suspect how insecure was a great part of the foundations of their authority, now strengthened by the recovery to their alliance of the island of Euboea (spring, 357), although the revolt of Coreyra in B.C. 361 was already a warning in this direction.

In the Peloponnese, Arcadia's prosperity collapsed. The Spartans mourned the irremediable ruin of their proud state. Their aged Agesilaus still hoped, indeed, to be able to bring about a change for the better, and concluded an alliance with the Egyptian king, Tachus, who wished to take advantage of a great insurrection of the satraps and coast peoples of Asia Minor (since 362) against Persia, in order to conquer the Phoenician coast. This alliance was to secure to the Spartans abundant means to renew the Messenian war. Agesilaus

himself, as Spartan general, departed (360–359) for the Nile, with 1000 hoplites. Rewarded with 230 talents, Agesilaus was returning home at the end of the year 358, but died on the way, leaving his throne to his son, Archidamus III. He was spared the knowledge that only the previous year a prince, the Philip whom Pelopidas carried to Thebes as hostage, had become regent of Macedonia, before whom, within twenty years, all Greece was to lie bound and prostrate, and by whose son his own splendid schemes of Asiatic conquest were to be more than fully executed.

Of all the figures of the age that closes with the death of Agesilaus, only Epaminondas — as the admired and unattainable model — and Agesilaus permanently held their place in the popular recollection. The latter once more represented the old Spartan type in highest perfection, though with all the limitations of the Laconian character. In contrast with the great Alexander of Macedon, who in many parts of Greece was so long looked upon with aversion, he was revered as the last Hellenic hero who had fought victoriously against the Persians. Among the Athenians, Xenophon, the able leader of the ‘Ten Thousand,’ was honored by posterity. At one time banished because of his friendship with Agesilaus, he was finally reconciled (after 369) to his countrymen, and died at an advanced age (not before 355). After the end of the Corinthian war, Xenophon was very diligent as a writer on many subjects in his solitude at Scillus, in Elis, where the Spartan government granted him an estate, as well as later at Corinth. Posterity esteemed him as a historian, admiring him more for the simplicity with which he renders his own experiences and the grace of his language, than for any art of plan or largeness of conception. His preference for Sparta, especially for Agesilaus, and his failure to view dispassionately the course of events, so painful to him, since Leuctra, detract from the value of his work. Nevertheless, he stood, even as historian, incomparably higher than his contemporary, the vain physician Ctesias of Cnidus, who, from 415 to 398, was private physician at the court of the Achaemenidae, and in this position had access to rich material, of which, with his feeble sense for historic truth and fidelity, he made meagre and inaccurate use. The other noteworthy historians of this epoch, before the Iranian East was laid open by Alexander the Great, — men like Ephorus of Cyme, whose history of Greece came down to a point just before the consummation of the Macedonian hegemony; Theopompus of Chios (born about 380), of aristocratic tastes, who told the fortunes of Greece from the end of the Peloponnesian war to the battle of Cnidus, and

treated also the age of Philip; and the Syracusan Philistus, the contemporary and kinsman of Dionysius I., the historian of Sicily and of this tyrant—are all known to us only from fragments and from the judgments of later critics. The influence of the rhetorical schools becomes increasingly evident in all fields of literary composition.

After the great Periclean age, the art of political oratory continued to be cultivated in Athens earnestly and with success. The fondness of the Athenians for litigation, and their never-failing abundance of lawsuits, and also of political processes, caused the art of forensic eloquence to flourish. As models in this direction ranked the speeches of Lysias, a highly gifted foreign resident, born at Athens, the son of a Syracusan father, a famous witness of the downfall and resurrection of Athens, who handled Attic prose with extraordinary facility. The



FIG. 165. — Isocrates. (After Visconti.)

art of showy oratory, on the contrary, owed its brilliant development to Isocrates (Fig. 165), who lived to a great age (436–338 B.C.). A friend of Socrates and of Plato, not naturally a popular orator, he made a name especially as a “political writer,” as it would be called to-day. The artistic compositions which he wrote, in the form of speeches, for the cultured world of his time, were, like the literary productions generally from the time of the Peloponnesian war, made accessible to the Athenians and the rest of the Greeks by a special class of copyists and booksellers. They served as

political pamphlets, since Isocrates expressed in them his ideas on what seemed to him the most important issues of the time. Thereby, as well as through his energetic sympathy with the fortunes of his country, he is very clearly distinguished from the Later Sophists of the imperial age, the artificial and showy orators whose brilliant speeches were always based on the dead past, and had the effect merely of oratorical exhibitions. But artistically Isocrates is their ancestor, because he developed the cultivation of style, first insisted upon by the earlier Sophists, into a complete rhetorical technique. As to the other arts of expression, the flourishing period of tragedy was long since past. Comedy no longer received its strength and impulse from the movements of public life. It took its subjects from every-day life; gave freer room to the ever-new and ever-interesting motive of love,



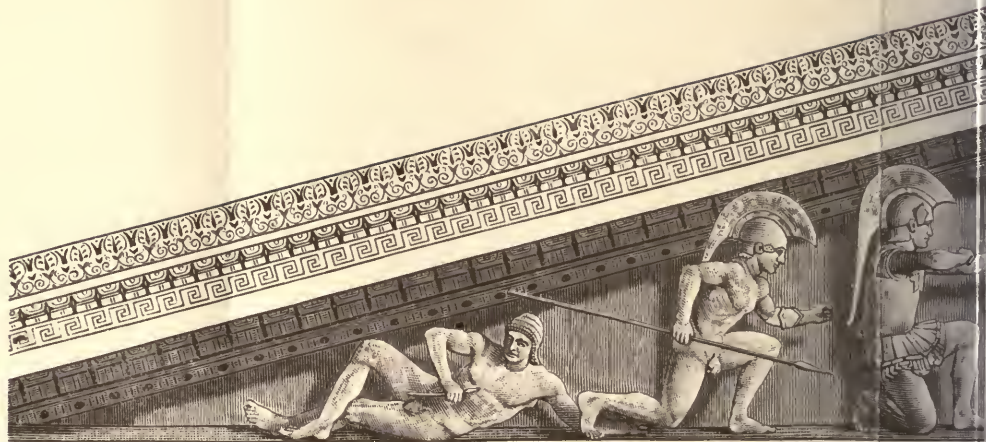
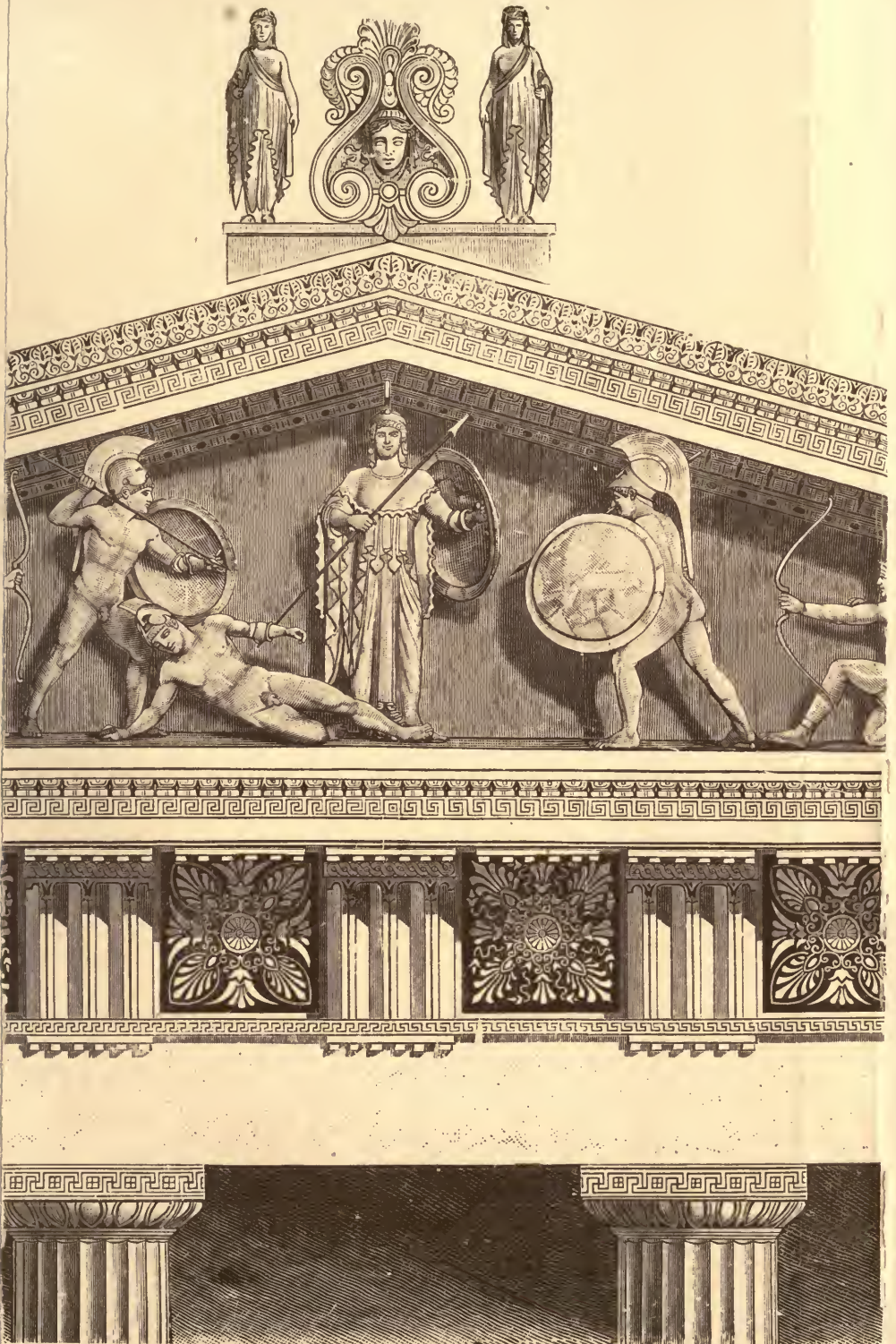
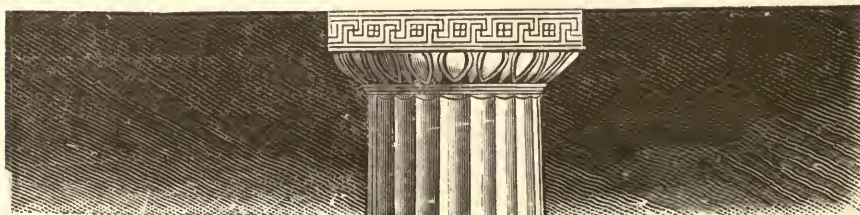
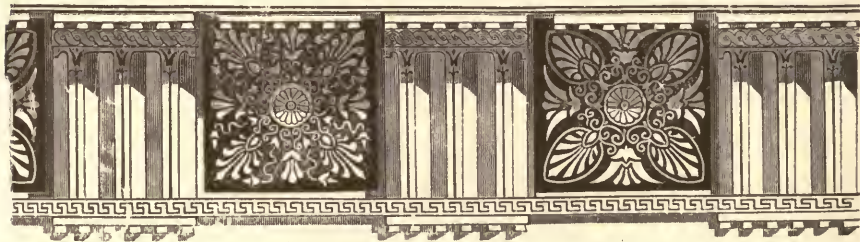
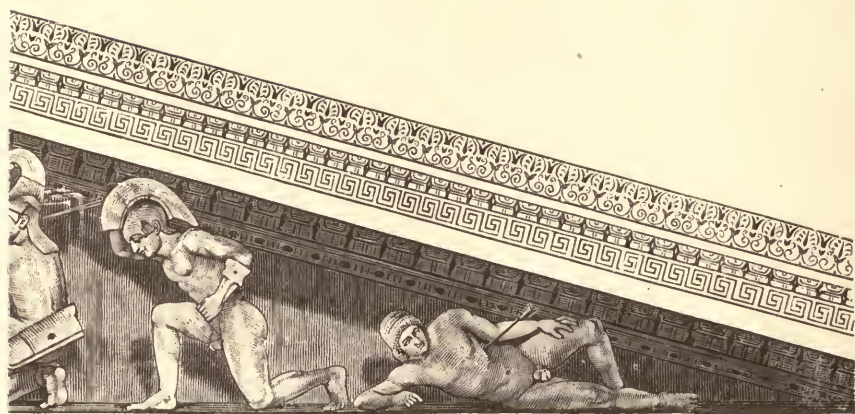

PLATE XIX.



Western pediment of the Temple at Aegina.

represent the struggle of the Greeks and Trojans about the body of Achilles, which Athena, armed with



lance and shield, protects.

created bright character-figures, and exercised its spirit of mockery on the poets and philosophers that were distasteful to it, on their peculiarities and errors, as upon everything that delighted, surprised, or vexed the public of a great city.

Incomparably more important was the position of the arts of sculpture¹ and painting. The many-sided Polyclitus of Sicyon, representing a naturalism ennobled by animated and beautiful conception, and the cultivation of moderation and graceful harmony of powers, had, until after 423, vied with the Athenian masters. Art followed, too, the changed spirit of the times, which demanded new incitements and charms. In architecture, where richer ornaments and new effective motives were sought, Callimachus, a younger contemporary of Ictinus, won great praise when he first set upon the shaft of the temple columns a basket-shaped cup of acanthus-leaves. This new 'Corinthian' style was applied with fine effect when the Parian Scopas, after the burning of the ancient temple of Athena Alea, at Tegea (B.C. 395), built for this city a new sanctuary, the most splendid work finished in Hellas since the erection of the Parthenon. Here he united an Ionian peripteros with a cella, which in the interior had a double arrangement of columns, below a Dorian and above a Corinthian. Scopas, whose prime belongs to the first half of the fourth century and later, followed in his repeated change of residence (first in the Peloponnese, after about 380 for a number of years in Athens, at the end of his life in Asia Minor) the growing inclination of Greek artists for a wandering life. He was at once architect and sculptor, and in Athens became the leader of a younger Attic school, which with grace and beauty, and a certain love of the sensuous and charming, united a high degree of animation and mobility, and great art in representing the emotions of the soul. The principal representative of this younger school was his somewhat younger contemporary, the sculptor Praxiteles of Athens, who in the creation of the graceful forms of women and delicate youths, in the expression of the emotions of the mind, especially in the execution of heads, and in the union of the highest grace and naturalness, seemed to posterity to be beyond rivalry. Praxiteles created during his best period (364–336) for Athens, Boeotia, Megara, Olympia (under whose ruins,² a few years ago, one of his original works was discovered, Fig.

¹ An earlier phase of Greek sculpture is exhibited in *PLATE XIX.*, which gives a reconstruction of the western pediment of the temple at Aegina, which was built in the first third of the fifth century. It was dedicated to Aphaea, a local goddess.

² The beautiful statue of Victory (Fig. 166), by Paeonius of Mende, set up near the great temple of Zeus, has also been recovered, though in a more fragmentary condition, from the ruins of Olympia.—*Ed.*

167), and for several Asiatic cities, a number of very celebrated works of art, especially statues of Apollo, Dionysus, Aphrodite, and Demeter. The statue of Eros of Thespieae, and that of Aphrodite of Cnidus, were in the time of the Roman empire still objects of universal admiration. The gifted naturalist, Lysippus of Sicyon, who wrought mainly in bronze, achieved his greatest successes in the time of Alexander the



FIG. 166.—The Niké (Victory) of Paëonius, found in Olympia. (From a Photograph.)

Great, through faithful representations of character in the portrait-statues of prominent personalities. His statues were marked, not only by perfect fidelity to nature, but by a thoroughly ideal character, uniting strength and grace. Above all, his portrait-statues were full of life and soul. Besides, he won great reputation as a sculptor of animals. In the judgment of the ancients, Lysippus reached the highest excellence conceivable, and, with Praxiteles, continued to dominate all later art.

Painting and the art of drawing, in which plastic forms prevailed, underwent — apart from the growing development of an important branch of artistic handiwork, i.e., vase-painting — a decided transformation at the hands of the Athenian Apollodorus. This artist, at the time of the Peloponnesian war, took the step from wall-paintings to easel-pictures; and by his coloring, and proper distribution of light and shade, achieved fine effects. He was surpassed later by Zeuxis of Heraclea, who was considered a master of coloring, and of faithful, but not at all slavish, observation of nature. In the ideal conception of his subjects, Zeuxis was unexcelled, and in the art of illusion was surpassed only by Parrhasius. The latter was born at Ephesus, but worked at Athens, and was distinguished for the life-likeness and character of his portraits. Besides Athens, there were at other places flourishing schools of painters, especially at Sicyon, where technique was brought to the highest perfection. Perhaps Sicyon's greatest artist at this time was Euphranor, famous also as a sculptor in bronze and marble. The great painter of Colophon, Apelles, who

has been well called the Correggio of antiquity, received his final training in Sicyon; but his prime belongs to the second half of the fourth century, and his art was devoted to the glorification of the martial princes of Macedon. Thoroughly trained, both in practice and theory, with perfect technique capable of achieving important effects with slight means, excelling in keen observation and comprehension of the characteristic, and exceedingly skilful in the treatment of what was in a narrower sense picturesque, this artist understood how to lend to his creations charm and grace.

The exact sciences also made more and more important advances. The science of war matured in the very next period, on the tactical side as well as on that of artillery, new and extraordinary inventions (Figs. 168–179). Medicine, which in the former period was cultivated with success at Croton and at Cos, was freed by Herodicus of Selymbria, and the gifted Hippocrates of Cos, his pupil, from its alliance with temple establishments, and, in connection with the philosophy of the time, placed on a scientific basis. Greek physicians play a conspicuous part from these times until the rise of the Byzantine empire. One of these men, the Cnidian Eudoxus (408–355), known as geographer, mathematician, astronomer, and philosopher, became the founder of scientific astronomy.

This man, like so many other leading spirits of the age, stood in close relation to the representatives of philosophy, which, finding in Attica congenial soil, afterwards won for Athens a new realm in the



FIG. 167. — Hermes of Praxiteles, found in Olympia. (From photograph.)

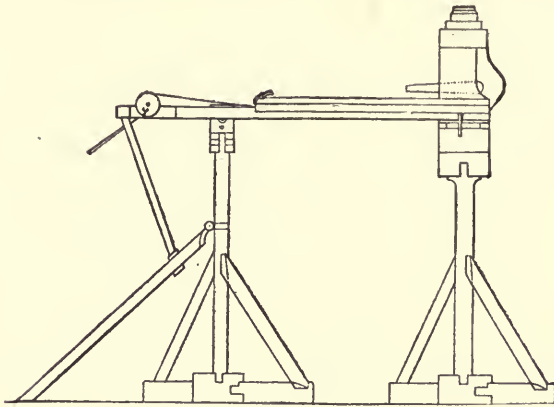

168.

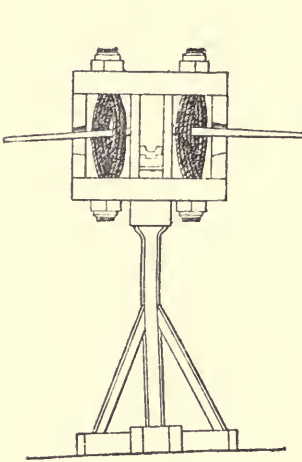

169.

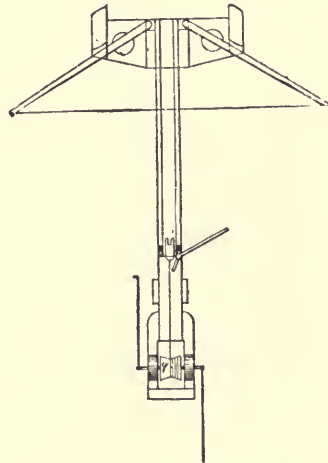

170.

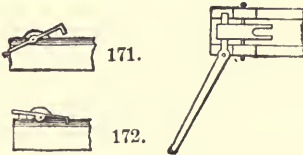

171.



172.

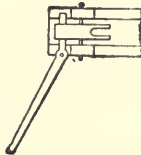

173.

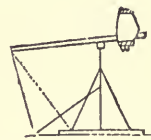

174.

FIGS. 168-174. — Greek Artillery.

FIG. 168. — Catapult, side view.
 FIG. 169. — Catapult, rear view.
 FIG. 170. — Catapult, seen from above.

FIGS. 171-173. — Pipe of the catapult.
 FIG. 174. — Catapult, with single beam.

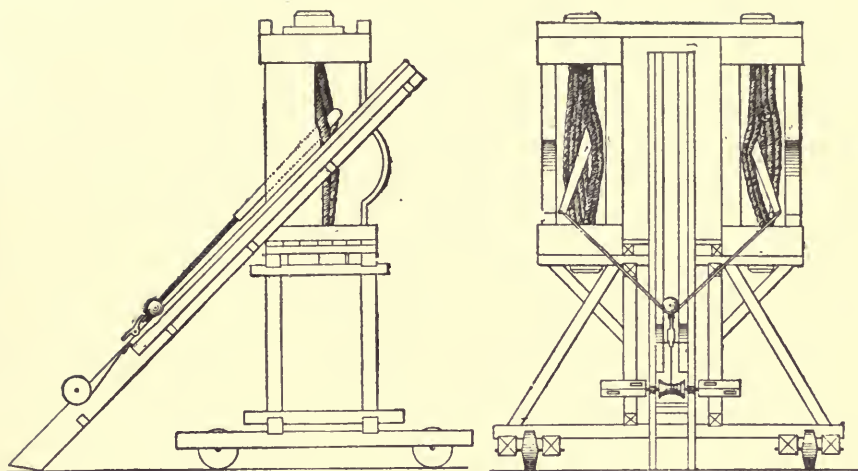

175.

176.

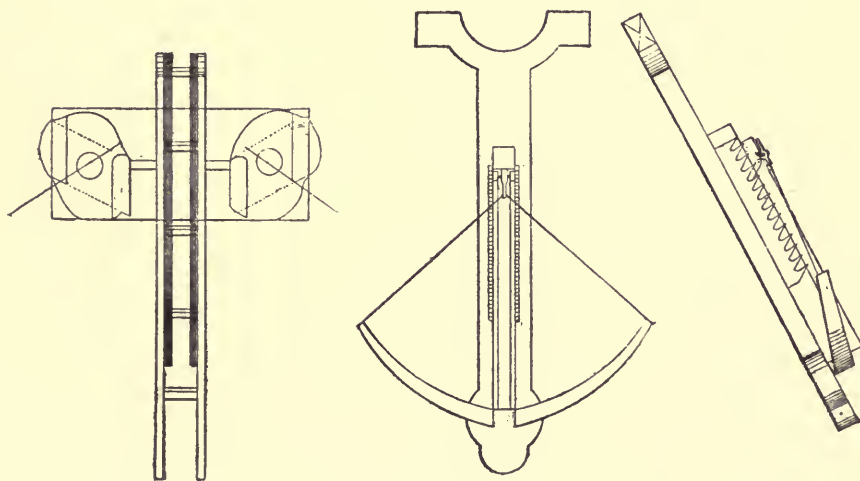

177.

178.

179.

FIGS. 175-179. — Greek Artillery.

FIG. 175. — Ballista, side view.

FIG. 176. — Ballista, rear view.

FIG. 177. — Pipe and projector of the ballista, seen from above.

FIGS. 178, 179. — Gastraphetes ('stomach-bow').

domain of mind. From the school of Socrates his Attic disciples had carried away very various impulses; and hence there grew out of the Socratic soil very different philosophical schools and systems, which afterwards multiplied, and continued to flourish in Attica as long as antiquity lasted. The foundation of the rich development of philosophy, which characterized the whole following period of Greece, was then laid. There we find the Athenian Antisthenes, who, at first a pupil of the sophist Gorgias, afterwards one of the most devoted adherents of Socrates, made Socratic virtue the central point of his system, laying chief stress, however, on the master's manly but roughly independent ideas concerning moral asceticism and renunciation of all outward good and enjoyment, even of such intellectual occupations as did not tend directly to exercise and strengthen in virtue. He taught in the Attic gymnasium Cynosarges, whence his disciples were called Cynics. Antisthenes stood in sharp contrast to the elegant Aristippus, who at the end of his period of study and of his travels, which took him to the court of Syracuse among other places, founded in his African home, Cyrene, the so-called Cyrenaic school, which considered philosophy more as an art of living, virtue essentially as moderation in enjoyment, and placed all knowledge and mental culture in the service of what was considered, though not in a vulgar sense, a 'happy life.' The followers of Antisthenes, among whom was Diogenes of Sinope, an original genius, who lived in the following period at Corinth, were in danger of carrying their asceticism to the point of actual coarseness and hostility to culture. In the later period of Hellenic civilization many of them played a part like that of the Indian penitents in Hindostan or the stylitae of the early Christian centuries.

Of quite a different character was that aristocratic spirit, who, endowed with brilliant gifts and a profoundly poetic nature, keen understanding, and a speculative sense to a degree rare even among this intellectual race, and revered as the greatest of all the disciples of the incomparable teacher, deepened and further developed in all direction the doctrine received from Socrates, arranged methodically the fundamental ideas of the Socratic system, and broadened them into a comprehensive conception of the whole moral world. This was the philosopher Plato, who (born May 21, 429) traced his descent from Codrus. From his twentieth year in close relation to Socrates, after the great teacher's death away for many years on his travels, on which he came into contact with the Pythagorean philosophy of Archytas of Tarentum, he opened, after his return to Athens (after 387 perhaps),

the philosophical school which was collected in and about the famous gymnasium of the Academy, — a name which received through him a never-fading consecration. A vigorous worker up to his death (348), Plato became, with his varied talents, his broad culture, and his skill in acquiring from the systems of other philosophers fruitful thoughts and germs, the progenitor of those philosophical schools, which, attaching themselves to his intellectual legacy, have vigorously maintained themselves wherever Greek civilization has reached, whether in the ancient or in the modern world.

334

BOOK III.

THE MACEDONIAN AGE.

(B.C. 362-217.)

336

PART V.

THE MACEDONIAN SUPREMACY AND
ALEXANDER'S SUCCESSORS.

(362-277 B.C.)

CHAPTER XV.

FROM MANTINEA TO CHAERONEA.

BEFORE taking up again the annals of continental Greece, we must ask the reader to accompany us for a moment to the island of Sicily, where events presently occurred worthy of the best days of Hellas. At Syracuse, Dionysius I. was succeeded, in B.C. 367, by his son, Dionysius II., an unpopular tyrant, with a taste for philosophy, whose interminable quarrels with his uncle, Dion (a pupil of Plato), and the Syracusan populace, exposed the island, almost helpless, to a great invasion of the Carthaginians, in 346. At this crisis the despairing Syracusans appealed to their mother city, Corinth, for aid. The Corinthians sent them Timoleon, born in 410 of a noble family, and so strongly republican that he had, twenty years before, caused his brother, Timophanes, to be put to death for endeavoring to enslave his country. Timoleon's character was in striking contrast to the spirit of the times. When all the institutions of liberty were falling, he held fast to republican traditions. He was known to be shrewd and energetic, possessing ability both as statesman and soldier; and the event proved the incorruptible integrity of his character.

With only ten ships and 700 soldiers Timoleon sailed, in the spring of 344, from Corinth to Rhegium, where he learned that the Carthaginians had conquered Syracuse, with the exception of the citadel, and were guarding the Strait of Messana with 20 ships. Eluding these, he landed at Tauromenium, where he was cordially received. Skirting Mt. Aetna, he won a victory over the renegade Hicetas of Leontini,

at Hadranum. The patriotic Sicilian Greeks flocked to his standard. Dionysius II. now made terms with Timoleon, gave up to him Ortygia, and withdrew to Corinth. While Hicetas with his African allies was besieging Ortygia, Timoleon succeeded in capturing (343) Mes-sana; and at a moment when the Carthaginian general, Mago, was absent from Syracuse, this also fell into his hands. Hicetas escaped to Leontini. Timoleon's glorious work now began, — the task of rebuilding unfortunatè Syracuse and training the people to self-government. The democracy was established on the basis of the old laws, and from various quarters a population of 60,000 was brought together. A heavy task remained in warding off the Carthaginians, who now, with more than 70,000 infantry and 10,000 cavalry, were preparing to avenge Mago's failure. With not more than 12,000 men, Timoleon met them near Entella, on the river Crimisus, and utterly defeated them. This was probably in the year 342. Later, a victory over Hicetas followed; and a peace was concluded with Carthage, by which the independence of Sicily was guaranteed. Crowned with the glory of these good deeds, Timoleon died in B.C. 336. Syracuse, for a considerable time, remained free and prosperous. Less fortunate were the cities of Magna Græcia, where, under the increasing pressure of the native tribes, only Tarentum continued to enjoy real independence.

On the same day that the Spartan King Archidamus III. fell in defence of Tarentum, did King Philip, on the plains of Chaeronea, gain the victory that forever ended Grecian supremacy. This result had been brought about within twenty years by the genius and activity of the young king, and as the effect of two fatal wars among the Greeks themselves. The history of Greece proper, during the period which we are now to consider, revolves more and more about a most extraordinary man, Philip, king of Macedonia. Regent in 359, as the guardian of the infant son of his brother Perdiccas III., slain in battle with the Illyrians, his abilities and the troublous condition of the state occasioned his acknowledgment as king within a few months, without violence, and by general consent. The young king now sought to gain breathing-space by mingled diplomacy and arms. Peace had already been concluded with the Athenians, who had prepared to support the claims of Argæus, a pretender to the Macedonian throne, in return for Amphipolis. They agreed (by a secret article) to give up Pydna, while Philip was to acknowledge their claim to Amphipolis. Now he turned upon the hostile Pæonians, defeated them, and forced them to acknowledge Macedonian supremacy. Then the

Illyrians were routed in a terrible battle, in which their leader Bardylis and 7000 of his men fell. By treaty the western boundaries of Philip's kingdom were now extended to Lake Lychnidus, so that the main passage to the Adriatic was in his hands.

But Philip was not content with these successes, and with each victory his horizon widened. He first set for himself a double task, — to push his kingdom to the limit nature seemed to have set for it, that is, to the sources of the Axios and the Strymon on the north, and to Mt. Rhodope on the east; then to break the power of the Greeks on the sea, and get possession of the harbors of the country. Thus brought into conflict with Greeks and barbarians, his plans were enlarged, and he further sought to bring into subjection the whole of the Balkan Peninsula as far as the Danube, and to win the leadership among the Greeks. For the accomplishment of this latter purpose, following out the political ideas of Cimon and Agesilaus, he revived the plan of an invasion of Persia.

Philip's first task was to organize into a strong military system all the power of the land. In this work he showed marked ability; and, copying the tactics of Epaminondas, he organized that army with which afterwards his son Alexander opened to the influence of Hellenism the Eastern world as far as the Jaxartes. The continual danger of war gradually accustomed Macedonia to a stricter monarchy. Both Philip and Alexander sought in every way to establish a military despotism. Military service was made binding and universal, and to the king belonged the duty of furnishing arms and pay. Yet a standing army was not organized; only the king's guard was always ready for service. The soldiers of this guard were called Hypastistae, and were in a manner hoplites, yet armed with lighter defensive weapons and with the pike of the Greeks. The youth of the noble land-owners formed the heavy cavalry. Thorough horsemen, protected by heavy armor, they carried sword and shield; but their principal weapon was the lance, with shaft made of the hard wood of the cornel-cherry. They were divided, according to the districts they came from, into squadrons, or *Ilæ*, of unequal strength. The *Agema*, or royal *ile*, the mounted guard of the king, consisted of the choicest riders, selected from various parts of the land. The heavy infantry came from the mass of the free Macedonian people. Successfully to meet the Grecian hoplites, Philip was led to the formation of the phalanx, which afterwards became world-renowned. The troops of the several districts formed regiments, or phalanxes; and these were subdivided into battalions of 512 men each.



FIG. 180. — Statue of Artemisia, Queen of King Mausolus of Caria. From the Mausoleum at Halicarnassus. (British Museum.)

These battalions were drawn up in actual conflict sixteen men deep, and the impetus of their attack was almost irresistible for Greeks as well as barbarians. Yet the inner ranks could be filled with raw recruits, provided only the outer were composed of drilled soldiers. The phalangites wore a broad-brimmed felt hat, leather jerkins covered with metal, and carried a heavy round shield. Their weapon of attack was the *sarissa*, a strong spear about 16 feet long,¹ which was managed with both hands, and was much longer than the lance of the Greek hoplites. But Philip's army, whose members were called *hetaeri*, i.e., 'brothers-in-arms' of the king, contained other divisions. Not every battle-field was adapted to the phalanx; and the flanks had often to be covered by light troops mounted or on foot. These were furnished by the subject Illyrians, Paeonians, and Thracians, and carried their own national weapons. Besides, there was the artillery, which embraced also the engineering force. Here Philip found skilled masters in the Thessalian engineer Polyidus, and his pupils, Diades and Chaereas. Finally, adopting a Persian custom, to encourage the growth of a soldier-nobility, and to furnish a school for the training of officers, a corps of pages was formed from the sons of the nobles, who at the same time served as hostages for their fathers' faithfulness. These pages formed an armed retinue in the palace, and in the field kept guard at the royal tent. Philip also made use of another weapon, which he knew how to wield with even more skill than the sword, namely, diplomacy. In knowledge and judgment of men and affairs, in the skill with which political preparation was made for military undertakings, in the art of patiently awaiting the proper moment, hastening not, nor yet delaying too long, finally in the dexterity with which he deceived and separated his antagonists, or even cast upon them the odium of acting unjustly, Philip was equalled by few and surpassed by almost none of the politicians of the ancient world.

He had, too, an advantage over the Greeks in his intimate knowledge of their excellences and weaknesses, while they for years underrated his power, and considered Macedonia as altogether beneath their notice. To carry out his plan for the conquest of the Macedonian coast, it was necessary for Philip to hinder any alliance between Olynthus, Athens, and Amphipolis. Happily for him, as he opened the war against Amphipolis in B.C. 357, the Athenians remained quiet, relying on his promise to deliver the city up to them. As soon as he had captured Amphipolis, however, he threw away the mask. This was the

¹ According to other accounts, 21 feet.

real beginning of the war with Athens, which he now prepared to prosecute with vigor. In the same year he conquered Pydna, the prize Athens was to have given him in return for Amphipolis. The next year he wrested Potidaea from the Athenian colonists, and turned it over to the Olynthians, who thereby were led to break completely with Athens. While in the camp at Potidaea the king received the joyful intelligence that the queen Olympias had borne him a son, to whom the name of Alexander was afterwards given.

The power of Athens had been constantly growing weaker since 357, on account of the defection of the strongest of her insular allies, through the intrigues of Mausolus, prince of Caria, whose tomb, the Mausoleum, erected by his wife Artemisia (Fig. 180), was one of the Seven Wonders of the World. These asserted and won their independence from Athens in the so-called Social War (B.C. 357-355), only to find a far worse oppression in local oligarchies, supported by Carian garrisons. The war was in every way disastrous for Athens. Chabrias was slain at Chios in 357. In 356 the Athenian commanders fell out. Chares procured the recall of his colleagues, and went off on a plundering expedition against the coasts of Asia Minor, which roused the anger of the Great King. The Athenians, terrified, hastily patched up a peace (355) by which the independence of all their principal allies was acknowledged. Their annual revenue from tribute was thus reduced from 350 talents to forty-five. The next year the generals recalled in 356 were tried for bribery. Iphicrates and Menestheus were acquitted; Timotheus, who relied on his innocence, and refused to humble himself before the judges, was fined 100 talents. He died in the same year; Iphicrates in B.C. 352; thus Athens lost her last able commanders. Worst of all, Aristophon and his vigorous foreign policy were discredited by the war; and his place was taken by Eubulus, who was elected public treasurer in 354, and was for several years the most influential man in the state. This politician was a skilful financier; but his plans, though at the moment seeming to be for the good of all classes, proved very damaging to Athens. The mass of the people was sinking into a proletariat. The great capitalists and land-owners, in whose hands rested the money of the country, were more and more disinclined to contribute their means for unproductive wars. The desire of evading the burdens of state grew constantly stronger, and led to wretched contests between the upper and middle orders. In public life, where the statesmen sprung from all the different classes had equal chance of sway, criminal processes played an important part. The usual charge was embezzle-

ment of public money, and the combats between influential orators were often fierce.

The new, and for a long time popular, system of Eubulus was, that Athens should now draw back, so to speak, within herself; devote her first energies to the restoration of her finances, to the fostering of trade, commerce, and other material interests. This was all good enough; but Eubulus and his friends overlooked the fact that a city such as Athens, whose traditional policy had embraced all Greece, could not at once settle down into such a *rôle* without great danger. With Philip of Macedon they failed to make peace, yet contented themselves with a lame defence against his aggressive measures; waited for him to attack their own possessions, disregarding entirely his acquisition of points which it was their own highest interest to protect. They were slaves to a policy which, content with the quiet of to-day, forgets that tomorrow action will be threefold more difficult. The restoration of Athenian finances was very successful, but was not used to provide state funds against a possible war. On the contrary, by disbursing the first year's surplus of his administration in celebrating the Dionysia, Eubulus encouraged the popular but dangerous practice of emphasizing the Attic festivals, and of using the Theoric Fund.

This turn in Athenian politics had an immediate consequence: for unwise purposes the king of Macedon, taking advantage of a war that had started in B.C. 355, effected for himself an entrance into middle Greece. After the Phocians had separated themselves from Thebes, on the death of Epaminondas, the latter people, supported by the Locrians and Thessalians, charged the Phocians before the Amphictyonic Council, in the autumn of 356, with occupying a portion of the sacred territory of the Delphic oracle. The Phocians were condemned; and it was decreed that their own territory should be forfeited, in case the fine was not paid within the appointed time. Hereupon the Phocian general, Philomelus, made a treaty with Archidamus III. of Sparta, who supported him with money and mercenaries, and, seizing Delphi, repulsed in bloody fight the Locrians, having promised, however, the Athenians and Spartans not to rob the temple. After fortifying Delphi, Philomelus advanced into Locris with an army of 5000 men, whereupon the Amphictyonic Council declared a 'Sacred War' against the Phocians, on behalf not only of the Boeotians and Locrians, but of all the Greek tribes between Olympus and the Phocian boundary. The allies, moved by race hatred and religious fanaticism, were guilty of every kind of violence; while the Phocians, driven to a struggle for existence, did

not hesitate to seize the very treasures of Delphi itself, and made their land the refuge for the most desperate characters that gold could buy. For some time the war continued with varying success. In the latter half of the year 354 Philomelus fell in battle, and the chief command devolved upon his brother Onomarchus. Turning the costly vessels of Delphi into money, he at first met with considerable success. He held the Thessalian nobility in check by uniting with the successors of Alexander of Pherae, the princes Lycophron and Pitholaus. In 353 he occupied Thermopylae, subdued the Ozolian Locrians, desolated Doris, and, pressing forward into Boeotia, laid siege to Chaeronea. At the same time his brother Phaëllus led 7000 men into Thessaly to support the princes of Pherae against Philip of Macedon, who had been called by the Aleuadae of Larissa to their aid. Here the exertions of Philip to attain supremacy among the Greeks take their beginning.

Since B.C. 356 Philip had used the embarrassment of the Athenians and the Phocian troubles for the furtherance of his own plans. He had extended his domain from Amphipolis eastward as far as the Nestus, had set up the strong fortress of Philippi on the northern side of Mount Pangaeum, which abounded in gold, and had established a mine here that soon brought him in a yearly sum of 1000 talents (over \$1,000,000). Then he began to equip a fleet, with which in 353 he captured the pirates' nest Halonnesus. In the same year he took Abdera and Maronea in Thrace, and the Athenian city Methone, on the coast of Pieria. Nothing now prevented his interference in the affairs of Greece, but his first attempt was not very successful. True, he defeated and repulsed Phaëllus; but Onomarchus, who had been forced by the Thebans to give up the siege of Chaeronea, now collected all his strength, and before the end of 353 inflicted two severe defeats on the Macedonians in Thessaly. But Philip was not discouraged. He busied himself with extensive preparations, and the following spring met and destroyed, with an army of 20,000 infantry and 300 cavalry, the Phocian army of almost exactly the same size. It was in thorough keeping with the character of this war that Philip, the 'champion of the gods,' caused 3000 of the sacrilegious prisoners to be cast into the sea, and nailed to the cross the body of Onomarchus, who had fallen in the battle. The strength of the Phocians was crippled; and it was some time before Phaëllus could, even by offering double pay, secure fresh troops. Philip had, indeed, won a great victory. Though the promptness with which the Athenians occupied Thermopylae hindered him from advancing southward, he yet gained,

besides the friendship of the Amphictyons, the supremacy in Thessaly. The princes of Pherae were driven out, and Pagasae and the promontory of Magnesia remained in Philip's hands. The rest of Thessaly he took under his protection, and thereby introduced that close union of Thessaly and Macedon which continued, with but few interruptions, till Rome's victory over the Macedonians at Cynoscephalae.

The year 352 was an epoch in Philip's history. In Thrace he subdued Cersobleptes, made treaties with Byzantium and Perinthus, and commenced diplomatic negotiations with Persia. Thus the king, who seven years before was struggling to maintain his little state, ruled now from the Gulf of Pagasae to the Bosporus.

From this time Philip begins to work earnestly for supremacy over Greece. From the standpoint of the later observer it is clear that after the fall of Sparta, the degeneracy of Athens, and the early decay of the greatness of Thebes, there could be only one issue of Hellenic history. By reason of the incapacity of the Greeks to stop their murderous feuds, and to establish in some measure political unity, it could only be a blessing that some stronger yet related power should force upon them peace and unity, and open new outlets to their energies. Macedon was no longer a stranger power; for Philip was himself thoroughly Hellenic, and had Hellenized his people. But none the less were these changes to cost hard struggles. History knows no case where a people of superior culture, and possessing historical fame, has willingly resigned its high position. Yet Philip could naturally expect that the Thessalians, who were more nearly related to the Macedonians in language and custom, as well as the Molossians — from whom about *b.c.* 357 he had taken the princess Olympias to be his wife — and the Aetolians would submit to him without difficulty. And as he did not wish to appear as conqueror south of Olympus, the Greek states, would they but acknowledge his hegemony, were in no direct danger from him. But Philip found that, at the very moment he began to carry out his plans, the old historic states, in the proud remembrance of their former glory, awoke, and roused themselves to a life and death struggle; and, naturally, the noblest and purest characters organized this resistance. In such men was the remembrance of the ancient glory of Hellas the liveliest; then, again, intelligent and high-minded Greeks could hardly be brought to intrust themselves to the leadership of a state that could any moment be thrown into anarchy by the thrust of an assassin's dagger. The noblest, too, were repelled by just those fea-

tures of Philip's character that prevent our ranking him with the great ideal figures of antiquity. His complete indifference to the moral character of his actions, provided only they brought success, his lying, deceit, and habitual bribery, make his personality no very pleasing one. Still deeper must it have stirred the souls of the Greeks to see this king, whose character otherwise shows no trace of cruelty, from purely political motives sweeping out of existence numerous flourishing Hellenic communities on the coast of his dominions. Besides, though it was not Philip's fault, all the traitors and cowards, the shameless, venal,

infamous scum of Greece, had pressed into his service. Thus it was that almost none of the Greeks east of Delphi and south of Thermopylae, with the exception of a few cities and parties that favored Philip for special reasons, joined the side of Macedon.

The war between the Phocians and Boeotians dragged along indecisively for years. Phalaecus, nephew of Phayllus, commanded the Phocians from 351 to 347, and met with considerable success. In the Peloponnese, the quarrels of the Spartans with Messenia, Megalopolis, and Argos continued; and thus it came about that these states became zealous partisans of Philip.

In the meantime a statesman was coming to the front in Athens as leader of a powerful opposition against the system of Eubulus. This was Demosthenes (Fig.



FIG. 181. — Demosthenes. Ancient marble bust. (Berlin.)

181), who with keen insight into the need of the Greeks, with enthusiastic patriotism, and with full appreciation of the might of Philip, nourished within his breast such a flame of conviction, and wielded such power of oratory, that finally he became the most dangerous enemy of Macedonian diplomacy. Born in B.C. 384, and therefore a little older than his royal opponent, son of a wealthy manufacturer of armor, at seven years of age left fatherless, he had passed a grievous and joyless youth. Though in early life eminent as a writer of speeches for the law-courts, it was with the greatest pains and by unceasing energy that he fashioned himself into a perfect orator. Schooled from childhood in Athenian law and life, thoroughly cultured by means of historical, rhetorical, and philosophical studies,

above all, a man of keen understanding, rare strength of character, high moral power, and indomitable energy of will, he began, in B.C. 354, to busy himself with affairs of state. With increasing emphasis he raised his voice against the many abuses in the state, and against the policy of Eubulus, which he saw played directly into the hands of Philip. In this direction, however, Demosthenes could advance but slowly. Eubulus still stood so firm in the favor of the people, that he succeeded in procuring for his scribe Aphobetus, at the elections in the summer of 350, the position of treasurer. He also brought it about that those who controlled the disposition of the Theoric Fund (at whose head he himself stood) should also have control of all the finances, so that they might use for theoric purposes funds from any quarter. He also got enacted the extraordinary law imposing the death penalty on any one who should ever propose using the fund for purposes of war.¹ But soon after this circumstances arose which awoke the better portion of the citizens out of their slumber, and enabled Demosthenes to win the upper hand, only in time, however, to save the glory of Athens, and to let her pass with honor, as a political power, from the stage of the world's history.

The Olynthians found their isolated position in the midst of the constantly increasing Macedonian dominion so uncomfortable that they concluded peace with Athens in B.C. 352, although such action was expressly forbidden by the terms of their treaty with Philip. As Olynthus could command 1000 cavalry and 10,000 hoplites, Philip began cautiously, and, to secure a pretext for war, demanded, in 349, the extradition of a noble Macedonian fugitive. Athens immediately made an alliance with Olynthus; but the help furnished was tardy and insufficient, owing to the state of Athenian politics, and the fact that the citizens preferred to stay at home and attend their festivities rather than undergo the toils of a campaign. The masterly and still extant orations of Demosthenes, who had just become a member of the Boulé, by which he tried to arouse the Athenians to a sense of their danger, derived strong support from the great success achieved by Philip in Chalcidice,—achieved, however, more through the influence of his gold than by his sword. In the summer of 348 Olynthus fell, betrayed by its own generals, before the fleet Athens had sent to its aid could arrive. In cold blood Philip now destroyed, not only Olynthus, but also thirty-two neighboring Grecian cities. When the news reached Athens, even Eubulus was roused for the moment, as was also his trusted agent,

¹ Doubt has been thrown recently on the actual passage of such a law.

Aeschines, brother of the treasurer Aphobetus, who, first a scribe, then an actor, now an orator of fine voice and stately presence, wielded a strong influence over the mind of the commons.

For many reasons King Philip was now desirous of making terms with Athens. To this Demosthenes was not disinclined, as he desired that Athens might collect her strength, and prepare for an earnest struggle. On the proposal of the orator Philocrates, who was already completely won for the king, eleven men, among whom were Philocrates, Demosthenes, and Aeschines, were sent, in February, B.C. 346, to Pella to effect a treaty with Philip. But Philip would hear to no terms save those based on the permanence of their respective possessions at that moment, whereby no advantage was to be gained by Athens. Worse than all, Aeschines was on this occasion completely won over to the king's side. This brilliant orator represents a rare class of Grecian politicians. The ordinary Greek traitor made no pretension to personal respectability, but sold his country, his conscience, and his service to the mighty king in Pella. But Aeschines would not pass for a traitor. He returned from Pella completely captured by the kindness of the king, convinced that it was impossible, and therefore foolish, to try to resist him. Afterwards, however, he became an unscrupulous tool of Philip, as it grew plainer that the king would spare no deceit or cunning to shake the power of Athens. But for the moment Philip persuaded all the ambassadors at Pella, even Demosthenes, that he was anxious for an honorable peace. On the appearance of a Macedonian embassy in Athens, an important debate was held in the general assembly on the 15th and 16th of April. The acceptance on the part of the Athenians of the *status quo* meant resigning themselves to their losses of the past eleven years; but there was nothing better to do. Demosthenes tried to improve the form of treaty presented to the assembly by Philocrates, and prevent the exclusion of the Phocians from the list of confederates for whom Athens was then acting. A clause was proposed granting "a space of three months within which admittance to the peace should be allowed to every other Grecian state." This would have given Athens the opportunity of becoming the centre of a strong confederation, and would have prevented Philip, for a time at least, from armed interference in the affairs of middle Greece. But this clause was rejected, and Athens had to content herself that the Phocians were not expressly excluded from the terms of the treaty. Since, further, the permanence of their possessions was guaranteed from the day on which the treaty should

be signed, Philip hastened to extend his Thracian dominions as far as Cardia; while the Athenian ambassadors, in spite of the warnings of Demosthenes, the only reliable man among them, were idling along, probably by previous agreement with the Macedonians. Finally they met with Philip in Pella, when he (June 17, 346) returned to his residence. The ambassadors further accompanied him to Pherae, in Thessaly, where peace was signed, but with the exclusion of everything definite in regard to Phocis.

On the 7th of July, 346, the ambassadors returned to Athens, and soon after followed the Phocian catastrophe. Although the Phocians themselves were sick of war, and of their mercenaries, to whom they had paid fully 10,000 talents (over \$10,000,000) out of the treasures of the temple, they still held possession of Thermopylae, and had recently dealt the Thebans some powerful blows. The latter therefore called on Philip for help, and concluded a treaty with him at the very time the Athenian ambassadors were in Pella. When everything was ready, the king ordered the Athenians to assist in re-establishing the authority of the Amphictyons at Delphi, which meant to leave the Phocians to their fate. The Athenians readily consented, being deluded by Aeschines, who persuaded them that Thebes, not Phocis, was the party really aimed at. But now, when the base Phalaecus saw himself isolated, he betrayed his people, made terms with Philip, and left Greece on the 17th of July with 8000 mercenaries. The Macedonian army then occupied Thermopylae, and soon after Phocis also. The old forms were restored in Delphi, and the Amphictyons, with the exception of the Athenians, were called together. The Phocians were ejected from the council; and their two votes were given to Philip, who had destroyed the walls of twenty-two Phocian towns, and distributed the people, stripped of their arms, into small villages. A heavy fine was also imposed upon them, until the Delphic treasure should be restored. The Athenians were now called upon to ratify the new organization of the Amphictyonic council, which even Demosthenes persuaded them to do, since a refusal would, without doubt, have brought upon them the vengeance of Thebes and her allies, as well as of Philip.

In the autumn of 346 Philip returned to Pella crowned with victory. He could now regard himself as the master of Greece. But he was soon to find that the humiliation to which Athens had been subjected in 346 had finally aroused the people, and made it possible for Demosthenes to become the leader of an energetic patriotic party.

The first work was to arouse the Athenian spirit, to form out of the young generation patriots of the old school, to put an end to the policy of large words and small deeds, thoroughly to demolish the system of Eubulus, to unite all their power for one decisive blow, and, as preparatory to that, to gain alliances in Greece, and thwart the plans of Macedon. But Demosthenes had already accomplished his most difficult task. Descended from no Eupatrid family, long dependent upon himself, his untiring activity and his superior political insight, he had to win, nay, rather create, his public. But the mighty orator understood how to develop the policy needful for Athens. Demosthenes was neither an idealist living in dreams of the past, nor a violent, inflammatory radical. The great statesman strove for what was practically attainable. He sought, in Athens itself, the adoption of a number of necessary financial reforms for the fleet and army, and the elevation of the citizens out of the dangerous curse of idleness; as concerned the relations of Athens to Greece, the revival of the sentiment of common nationality, and the renewal of the great alliance which had of old hurled Persia back beyond the Hellespont. Towards Philip he advocated a ready, watchful attitude; the avoidance of needless conflict, but an emphatic, firm stand whenever the interests of Greece or of Athens seemed in danger. In no case was resistance to be postponed until the wily and powerful enemy threatened definite Athenian interests or territory.

Thus Demosthenes succeeded, soon after the year 346, in making himself leader of a strong party, in overthrowing the prevailing system of politics, and in uniting to his cause several highly endowed statesmen. The most important one of these was Lycurgus, a scion of the ancient house of the Eteobutadae, an Athenian of the old stamp, true and frank, strict toward himself and others. He was especially adapted for the management of the finances. On the other hand, a brilliant and graceful orator was found in Hyperides, who helped to stir the people from their inactivity by his passionate eloquence.

The struggle which Demosthenes and his friends carried on from the year 346 against Philip bore a double character. Outside the city, it was at first only defensive. They sought merely to organize and give form to all the opposition felt throughout Greece to the policy of Macedon. In Athens itself, however, the contest was thoroughly offensive; and they sought constantly to win more influence in the Boulé and assembly, and to drive the party of Philip from the field. The partisans of the king made this exceedingly difficult. One great advantage

which Philip had over the democracy of Athens was that he matured his plans in secret, and was responsible to no one for his decisions, while at Athens all matters had first to be discussed in open assembly. Thus Philip's partisans, whether paid demagogues and adventurers or eminent orators, could hinder very effectually the national party at Athens. Among these partisans was Demades, a seaman's son, without education, but possessed of unusual oratorical talent, who had trained himself to be a perfect debater and extempore speaker. Of quite another kind was Phocion (Fig. 182), who was then fifty-six years old, and one of the best officers of the state. He had no exceptionally brilliant natural endowments; yet in strictness of morals, purity of life, unselfishness, and simple devotion to duty, he rivalled Lycurgus. But his pessimistic nature could not comprehend the idealism of Demosthenes, and only hoped for safety in preserving peace with Philip.

In spite of all difficulties, however, the national party succeeded in gaining a constantly firmer footing among the citizens, and in checking, at some points, the advances of Philip, who had been striving since the autumn of 346 to extend his power. In B.C. 344 Philip made treaties with the aristocracy of Elis, Messenia, Megalopolis, and Argos; but when he tried, in 343, to win over Megara to his side, using for this purpose the local oligarchy, his plans were frustrated by Athens. In Euboea,

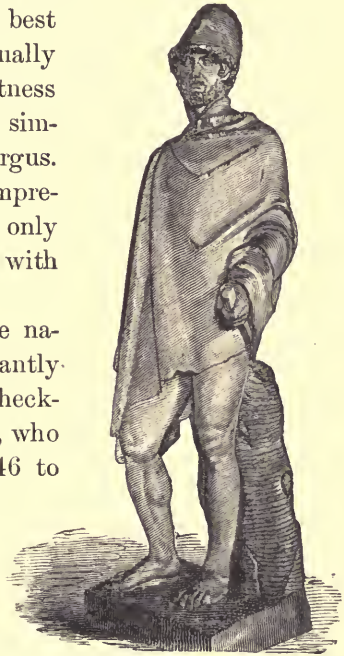

FIG. 182. — An Athenian general (Phocion?). Marble statue.

Philip gained Oreus and Eretria, while Athens succeeded in forming an alliance with Chalcis. About this time the king marched into Epirus, in order to overthrow the Molossian prince, Arybbas. At the same time he purposed forming an alliance with the Aetolians. The Athenians took the part of Arybbas, sent ambassadors through the Peloponnesus and the west of Greece, and despatched a body of troops to Acarnania. The relations between Philip and the Athenians thus became intensely critical, and the feelings engendered soon led to war. From the summer of 342 Philip began the conquest of Thrace, which he pushed as far as the Euxine, that he might have a secure basis of

operation in the future war with Persia, and, on the other hand, that he might command the grain-trade that passed through the Bosphorus and Propontis, and supplied Athens. Just as he reached the Black Sea in 341, the refusal of the Perinthians and Byzantines to submit to his sway gave the starting-point of the great Hellenic war.

Athens had already begun the conflict. The energetic *strategus* Diopithes, who was sent to strengthen and watch over the Athenian settlers in the Chersonese, began in 342 a conflict with the Greeks of Cardia, *protégés* of the king. When Philip sent them assistance, Diopithes made a successful irruption into the Thracian territory on the Propontis, which had been for years occupied by the Macedonians. Hereupon the king sent complaints and threats to Athens, though this bold stroke had been managed very much after the manner of Philip's conduct toward the Athenians. The assembly, on motion of Demosthenes, ratified the action of Diopithes. With this the diplomatic rupture with the court of Pella was decided. So stood matters in March, B.C. 341. In June, Demosthenes delivered his mighty Third Philippic, called upon the people to bestir themselves for war, and urged the formation of a Hellenic union for common defence against Macedon.

Demosthenes and his friends now possessed the leading influence in Athenian politics. By his own personal efforts peace was restored in 341 with Byzantium (hostile since the Social War), and an alliance formed. Persia could not be roused against Macedon. Hyperides succeeded, however, in arousing the Chians and Rhodians for the defence of Byzantium. In Greece proper substantial success was met with. In company with Callias of Chalcis, Demosthenes undertook journeys to the Peloponnesus and the west of Greece. Sparta held aloof; but Corinth, Achaia, Acarnania, Coreyra, Ambracia, and Leucas joined the alliance of the Euboeans, Megarians, and Athenians against Philip. A free confederation, under the leadership of Attica, was established at Athens, March 9, B.C. 340.

In the summer of 340, Philip appeared on the Propontis with a large force, and at once besieged Perinthus. The city, however, was strong, and all direct assaults failed. The king resolved to leave Antipater to continue the blockade, while with his main army he advanced against Byzantium. The Athenians had already declared war, and now sent Chares, with forty ships, and with mercenaries, to the Bosphorus. Strengthened by other re-enforcements, especially from the islands of Chios, Cos, and Rhodes, Chares and the Byzantines inflicted a heavy

blow on the Macedonian fleet, and drove it into the Black Sea. Then the Athenian fleet took position at Chrysopolis, and held the Bosphorus open to the Greeks. In the following February (339), the Athenians sent a second fleet under Phocion and Cephisophon, so that Philip had no more hope of success in that quarter. By deceit and diplomacy he succeeded in getting his fleet out into the Aegean, whereupon he withdrew his armies from Perinthus and Byzantium, and began to operate against the tribes of northern Thrace.

Demosthenes had given the king a severe blow, and at the same time established several important reforms in Athens. Immediately after the declaration of war he was appointed superintendent of naval affairs, and energetically introduced many important military measures. Of the greatest importance was his reform of the trierarchies and the symmories, which he organized in such a way that the naval services required of each citizen eligible to the trierarchy were proportioned to his property. About the middle of the year B.C. 339, Demosthenes secured important means for carrying on the war. There was no longer any hindrance in the way of using the theoric fund for war purposes. Since 347 the fleet had been increased to 300 vessels, and the construction of a magnificent naval arsenal begun under the direction of the architect Philon. At present the work was interrupted; and these funds, as well as the surplus amounts that had heretofore been expended on festivities, were turned to purposes of war. By the election of 338, Lycurgus was chosen treasurer. All this, however, had come ten years too late. The work of Demosthenes was nearing its tragic end. The victory of Byzantium could not be repeated. Where was the land force with which to strike an effective blow into the very heart of the enemy's country? For ten precious years Demosthenes had been struggling like a hero, with wind and weather against him. At last he had aroused the people, but the only glory he was to have was that of closing the history of Athens with an honorable downfall.

Had Philip returned direct to Macedonia, after the failures at Perinthus and Byzantium, his prestige and influence must have been seriously weakened. It was a master-move on his part when he led his army from its camp on the Propontis northward, over Mt. Haemus. Here he destroyed a powerful Scythian army, and established the Danube as the terminus of his kingdom. Then he moved westward through the country comprised in the present Bulgaria and Servia, overcame the Triballi, and marching along the valley of the Axios,

reached Pella towards the end of the summer of 339. In October of the same year there came to him from Delphi, where deceit and passion had been working in his behalf, the call that opened to him again the gates of Greece. While the people and leaders of Athens, with marked energy, had been effecting the deliverance of Byzantium, a small body of voters gathered together at the beginning of March, and made the mistake of electing Aeschines to go as representative to the meeting of the Amphictyonic Council to be held in Delphi soon afterward. Through the intrigues of the Thebans, perhaps also of Philip, the



FIG. 183. — Antique marble statue of Aeschines, at Naples. (From a photograph.)

representatives of the Ozolian Locrians of Amphissa charged Athens before the council with having set up afresh some golden shields won from the Thebans and Persians at Plataea in the temple at Delphi before its purification had been completed. Aeschines, in refuting this accusation, brought forward a counter-charge, namely, that the Amphisseans had appropriated the plain of Cirrha, a valuable piece of the ancient temple property. His speech excited the Amphictyons and the people of Delphi so much, that on the following morning they proceeded to lay waste the settlement of the Amphisseans. But as the fanatical rabble was returning home, the exasperated citizens of Amphissa fell upon and routed them. Hereupon an extra session of the council was called to meet at Thermopylae, and decide upon a war of vengeance against Amphissa. Athens and Thebes did not care for another

‘Sacred War,’ and sent no representatives. But the friends of Macedonia assembled, and commissioned the Thessalian, Cottyphus of Pharsalus, to open the campaign against Amphissa. This he did in the summer of 339; but, as he was not very successful, the Amphictyonic Council, which assembled again in October, committed the conduct of the war to Philip, who set out immediately for the south. In

PLATE XX.





Young warriors arming for battle with the assistance of their squires.

Painting on an Athenian cylix : early fifth century B. C.

the meantime the Locrians had equipped themselves (PLATE XX.¹) and formed a hasty alliance with the Athenians, who sent to their aid an army of 10,000 mercenaries, under command of Chares. But the generalship of Philip enabled him to win the passes that led between Parnassus and Mt. Corax without a fight. Reaching Amphissa, he destroyed it completely, and pressed forward to Naupaetus, which he captured, and delivered up the Aetolians. Then turning eastward, he seized Elatea in Phocis, the most important strategic point in middle Greece, situated at the intersection of all the great roads that traversed the country. Here he awaited the arrival of re-enforcements from Macedonia and Thessaly under Antipater.

This was in the autumn of 339, or early part of 338. The Athenians, thoroughly aroused by the news of this action of Philip, willingly

¹ EXPLANATION OF PLATE XX.

The picture in the centre shows a warrior arming in the presence of a white-bearded old man, his teacher or father. The old man bears a crooked stick; he is clad in chiton and himation, and a band is thrown around his head. He holds the young man's helmet in his left hand, and with his right extends to him an article of equipment, the purpose of which we cannot exactly determine. His glance is directed to something behind him not included in the picture. The warrior himself has already donned most of his armor. He is on the point of putting on the second greave, and attitude and countenance express the impatience with which he strives to complete his arming. His shield lies at his feet; his spear stands near him.

The outer pictures of the cylix represent similar scenes. In the first group of the upper row, as represented in the plate, a warrior is seen, with three figures busied about him. At the left a young, beardless man leans forward, supported by a staff, and offers a chlamys to the warrior. At the right of the warrior we have, first, a bearded, elderly man in short chiton, who hands him a sword and belt, and holds the greaves in his left arm; second, a beardless young man in a long himation, leaning on a staff. The warrior himself wears the short chiton. His eyes are fixed so intently upon the sword he holds in his hand that he seems to disregard entirely the one which is being offered to him. Wallet and lance are seen against the wall.

This row also contains a smaller group of two figures. A bearded man in short chiton is putting on his armor. A large shield stands at his left. A spear leans against the wall. At his right, a naked boy offers a string or chain.

In the lower row (the opposite half of the cylix) we have three scenes. At the left is a young warrior, who, having already donned his light armor, supports a shield with the assistance of a boy. Behind him is a low seat, on which a garment is thrown; above this, on the wall, is a wallet corresponding to that mentioned above.

The next group includes a bearded man, with head-band and short chiton. He has already put on his armor, and is at the point of girding on his sword. A small naked boy brings to him from the right his helmet and a large shield, on which is emblazoned a Centaur, bearing a tree-trunk. The next figure, a full-grown man, is probably the squire of the bearded man; he carries a spear and a mantle.

The youth at the right is putting on a greave, while behind him his convex shield, with the helmet upon it, lies on the ground. On the wall above hang sword and helmet, which, perhaps, indicate that the scene is to be considered to represent a sort of general armory.

[This vase was painted at Athens probably early in the fifth century B.C., and represents the armor worn in the Persian War. — ED.]

submitted themselves to the guidance of Demosthenes. All the citizens were called to arms, and marched toward Eleusis. Demosthenes himself hastened to Thebes to conclude an alliance of war against Philip. In the Boeotian assembly he succeeded, by the power of his eloquence and patriotism, in driving the ambassadors of Macedon from the field; and he moved the Thebans to accept all his propositions. Energetic preparations began on the side of the Greeks, who now showed a patriotism and unity of purpose which, if shown twenty years earlier, might have made Philip's career impossible.

When all was ready, the Athenians joined the Boeotian army at Thebes, and together they closed the passes along the Cephissus that led from Phocis to Boeotia. Philip's position was now uncomfortable, especially as the Greeks came off victorious in two considerable skirmishes. But, in the long run, it appeared that the Greek army was at a disadvantage, composed, as it was, of so many contingents. The commanders, too, — Theagenes for Thebes, Stratocles, Chares, and Lysicles for Athens, — were inferior in ability to Philip and his generals. After the king had received re-enforcements from Macedon and Thessaly and the districts of northern Greece, he despatched a part of his troops by mountain paths to the north and east of Boeotia, where they committed fearful depredations. Thereupon the Thebans turned eastward to protect their territory, and gave Philip an opportunity to wrench the pass of the Cephissus out of the hands of the other Greeks. The decisive battle was fought, probably on August 2, 338, on the plain near the Boeotian city of Chaeronea. The army of Philip was composed of 30,000 infantry and something more than 2000 cavalry, while the Grecian host was equally as large, possibly a little larger. On the Greek left were the Athenians, on the right the Boeotians, and in the centre the smaller contingents; on the Macedonian right Philip was stationed, and on the left Antipater, with Alexander, the crown prince, now eighteen years old. Demosthenes fought among the Greeks as an ordinary hoplite. The enthusiasm on both sides was great, but the thorough discipline of the Macedonians proved more than a match for the Greek tactics. The Athenians, on their side, repulsed the king; but Alexander, who here first displayed his incomparable genius as commander, drove back the Thebans, whose 'Sacred Band' was cut to pieces without yielding a foot. The prince now routed the centre and joined Philip, and together they drove back the Athenians. At the close of the day a thousand Athenians lay dead on the field, while double that number were captured.

Philip's victory was complete, and the Greek alliance was practically dissolved. The hardest fate fell on Thebes, whose glory and power were forever extinguished. The city was restricted to its old territory, the Boeotian confederacy was dissolved, its cities again made autonomous, and Orchomenus, Plataea, and Thespieae were restored. A Macedonian garrison was placed in the Cadmea, and the government of the city was put into the hands of fanatical partisans of Philip. The fate of Athens was different. The respect of the king for the spirit of the Athenians was only increased when he heard that, in spite of their severe defeat, they were preparing to continue the struggle to the death. Demosthenes, who was still held in confidence, guided every step with vigor and foresight. The siege of Athens was also not a matter to be undertaken lightly. Philip would have been exposed to a fate similar to that which befell him at Byzantium, and, even if successful, could hardly have undertaken the war against Persia, after destroying the home of the heroes of Salamis. He sent, therefore, the demagogue, Demades, to announce to the Athenians that he was disposed to grant them a favorable peace. This Demades was one of the prisoners who had been captured at Chaeronea. The hope of peace checked the efforts of the people, especially as Demosthenes was absent at the time, buying provisions and collecting contributions from the allied islands. Demades, Aeschines, and Phocion were appointed to treat with Philip in regard to prisoners, and consult for the best interest of the state. Philip freed the Athenian prisoners without ransom, and thus paved the way for the acceptance of his terms of peace, which were shortly afterward presented by Alexander and Antipater. The terms were favorable, considering the situation of affairs; and Athens accepted them. The Chersonese and Scyros fell to Philip, while Athens retained Attica and the islands of Salamis, Delos, Samos, Lemnos, and Imbros. But Athens had to resign her position as head of a confederacy, for all the other islands were made autonomous. Entrance was to be allowed her, however, into a new confederacy which the king thought of establishing; and, to win over the Athenians to this enterprise, he gave them back the city of Oropus, which Thebes had wrested from them thirty years before. Thus intense bitterness replaced the friendship of Athens and Thebes. As Demosthenes was still absent, the pro-Macedonian party held the reins of power, and all the proposals of the king were readily acceded to.

In the meantime, Philip had succeeded in appeasing the Phocians, in putting his adherents in power in Euboea, and in establishing a garri-

son in Chaleis, one of the most important strategic points in Greece. Then he set out for the Peloponnesus. Megara and Corinth opened their gates at once, and Acrocorinthus was supplied with a Macedonian garrison. The Argives, Arcadians, Eleans, and Messenians flocked to the king as he proceeded to desolate Laconia, in punishment for the obstinacy with which his commands had been rejected. All the boundaries of this ancient state were narrowed, and the entrances to the valley of the Eurotas were placed in the hands of the enemies of Sparta. And now, when even Byzantium had made terms, ambassadors assembled at Corinth, in the autumn of 338, from all the Greek world; a general peace was concluded; and terms were agreed upon, giving to the king complete supremacy in Greece.

But all forms of diplomacy could not hide this fact: that the old states of Greece ceased from this date to direct the historical movement of the times. Political unity was now forced upon the Greeks, — a people hitherto so far removed from unity of any sort that they could not even agree on common names for the months of the year. Philip created a Hellenic union, at the head of which was the Macedonian kingdom. By the Congress of Corinth the freedom and independence of all members, security of possessions, and the preservation of internal peace, were made the chief aims of the alliance. Feuds between the several states were forbidden, free intercommunication was to be allowed by land and water, the constitutions in force at the time of the formation of the confederacy were to be preserved, and a general council, whose members were taken from the various states, was appointed to carry out these regulations, and also to institute proceedings against any who might cause disturbance or seek revolution. The restoration of places that Philip had destroyed, as Amphissa, the re-establishment of governments which he had overthrown, and the recall of parties he had banished, were forbidden. The Amphictyonic Council, which was completely under the power of the king, was given supreme jurisdiction in all matters. Could it be expected that the proud Boeotians would endure their fall, Sparta her hopeless degradation, and Athens her loss of supremacy, without complaint? Philip hoped it. At least, he hoped that a national war against Persia would establish a new bond of union between the throne of Pella and the Greeks. He had himself appointed, by the council of the confederation, commander of the Greeks, with unlimited powers by land and by sea, and issued orders forbidding any of the Greeks to bear arms against him under pain of banishment and forfeiture of prop-

erty. The official register of the confederates showed that they were then able to bring into service 200,000 infantry and 15,000 cavalry, though it was never their intention to put all these in the field at once.

Two parts of his mighty plan had now been carried out by Philip. The Balkan Peninsula of the north, and the Grecian states of the south and in the Aegean Sea, were in subjection to him when he returned to Pella in the beginning of the year 337. But the supremacy over the Greeks had been dearly bought. The political principles of the king, his bribery, and treachery, and constant efforts to sharpen the local antagonisms that opened the way for his phalanxes, had created an impassable breach between him and the noblest spirits of Greece. It was long, indeed, before the Hellenes and the Hellenizing Greeks of Macedon could feel themselves members of the same great nation; and it was not till after many generations that the Greeks learned to treasure up the world-famed deeds of Alexander as part of their own history. To the genuine Greeks, Philip was at that time a foreigner; and it was to them a bitter feeling that the power of Greece should now be used for alien interests at the will of a foreigner. For, with the exception of a few ideal enthusiasts, there were few among the Greeks who felt any interest in a national war with Persia. The old hatred of Persia had long since died out. Not even Artaxerxes III. (Ochus), who had brought under his sway all Asia as far as the Aegean, and in 340 enslaved Egypt, could arouse their hatred. Many regarded Persia as their most available support in case of a new struggle with Macedon, especially as Bagoas, marshal of the court, had, in 338, murdered the Great King and all his sons save two, the youngest of whom, Arsēs, he raised to the throne. At Athens the commons were ready to receive the unholy present of Oropus from Philip's hands, yet they were not willing to declare that the great leader had done wrong in urging the contest with Philip. Though the logic of events decided against him, there was no charge of personal guilt. Demosthenes had nobly discharged his duty as guardian of Hellenic honor, and it was fitting that his voice should eulogize those who fell at Chaeronea, where their ashes were interred with honor in November, B.C. 338.

But the magic powers of the Greeks in art, science, and learning, remained their inalienable possession. These were the spiritual weapons with which they were soon to conquer the world of antiquity. One of the leading spirits of the age had already come in contact with that colossal figure whose military might was to complete the work of Philip. Aristotle (Fig. 184), a Greek from Stagira, a city of Chalci-

dice, which was later on destroyed by Philip, was born in B.C. 384. His father was the court physician of the Macedonian king Amyntas II. At seventeen years of age (367) he came to Athens, where he spent twenty years, and was one of the most distinguished pupils of Plato. After Plato's death he left Athens in 346, and betook himself to his



FIG. 184. — Aristotle. (After Visconti.)

friend, Prince Hermias, in Atarneus. On the death of Hermias, in 344, he removed to Mitylene. An original and universal genius, with enormous information in the most varied branches, Aristotle not only united the Socratic-Platonic idealism with a scientific realism, but by virtue of his method may almost be regarded as the founder and creator of the science and learning of the Greeks. He not only developed the theory of the syllogism and of logic, of ethics and of politics, but he was also regarded among the ancients as the founder of the theory of poetry, of rhetoric, and the philosophy of art. From him was derived the impulse to the anti-

quarian, philological, and literary study of subsequent periods; and he was the creator of the sciences of zoölogy, of comparative anatomy, and of botany. This was the man King Philip called in 343 to Macedonia, and to whom he intrusted the education of the crown prince, Alexander, then thirteen years old. Thus Hellenic culture was united with Macedonian strength, and the prince of Greek science trained the ablest ruler that the Greek world produced.

CHAPTER XVI.

ALEXANDER THE GREAT.—THE LAMIAN WAR.

WITH the founding of the Hellenic confederacy under Philip's supremacy, Greek military prowess, Greek science, and Greek intellect entered the service of the Macedonian rulers, and aided in pushing forward their conquests, until the Macedonians in turn gave place to the Romans.

It was Philip's purpose to commence the war against Persia as soon as possible. To this end he sent, in the spring of B.C. 336, two of his most trusted generals, Parmenio and Attalus, with 10,000 troops, to the southern part of Aeolis, to secure a base for operations in Asia. Although the Persians were surprised, they offered the Macedonians obstinate resistance. A faithful adherent of the Achaemenidae, Memnon of Rhodes, a man of unusual military and diplomatic talent, opposed them vigorously with 4000 Greek mercenaries. But now a catastrophe was hanging over the court at Pella. King Philip and his passionate, jealous spouse, Olympias, had become estranged; so that, in the summer of 337, he chose Cleopatra, the beautiful niece of his general Attalus, to be his wife. A few months later, as the wedding-feast of Philip's own daughter, also named Cleopatra, was being celebrated at Aegae, preparatory to his expedition to Asia, sudden death overtook the king. Pausanias, a noble youth, and favorite of Philip, had lately been deeply outraged by Attalus; and, as he could obtain no satisfaction against the mighty uncle of the young queen, he turned his hand against the king himself. Possibly he was encouraged by other powerful enemies of Philip. In the midst of the festivities at Cleopatra's wedding, August, 336, he slew the king with a sword-thrust, and was himself cut to pieces on the spot by the guards.

The news of Philip's death produced the profoundest impression on the whole world, from the Adriatic to Susa. In Persia a complete sense of security was restored; and the west passed all the more out of mind, inasmuch as the marshal Bagoas, just before the end of the year 336, had murdered Arses and his children, and had raised to the throne

a grand-nephew of Artaxerxes II., the amiable Codomannus, who assumed the title of Darius III. Bagoas soon after began intrigues against him, but was now in his turn put out of the way. Though Asia was quiet, Greece was mightily stirred from centre to circumference. The Hellenes underestimated Alexander completely, and thought the time had come to win their old freedom. Even Thessaly and Aetolia contemplated breaking loose from the court of Pella. The joy with which the national element at Athens, Demosthenes at the head, greeted the news from Aegae, was most excessive. Preparations were immediately set on foot, and ambassadors were sent to the several Greek states to urge them to a struggle for independence. But before it was possible to conclude new alliances, and get an army ready, the young hero who now wore the Macedonian crown appeared suddenly on the scene.

Alexander was born July 21, B.C. 356, at Pella. To the whole court, as well as to his teacher Aristotle, his rare endowments, his burning ambition, his heroic soul, were well known. The sensual nature of his family did not appear in his youth. In early life his mind was bent on great and high things, yet he was subject to violent emotions and passions. His first teacher, Leonidas, cousin of Olympias, accustomed him to simplicity and privation. In 343 he was placed under care of Aristotle, whose training was most beneficial to him, in view of his princely calling. An enthusiastic admirer of Homer and Hellenic culture, he gained, through contact with Aristotle, a deep and lasting fondness for Hellenic art and science, and a generous breadth of character which stood firm till undermined by the temptations of the Orient. The cosmopolitan bent, too, of the great teacher found its practical expression in the broad activity of Alexander. In the latter years of his father's reign, his studies were repeatedly interrupted; and during the war against Byzantium, B.C. 340-339, he held the reins of government for his father. After Philip's death, while his position was still by no means assured, the young prince showed that he shared his father's peculiar ability to seize and thoroughly use every opportunity offered. It was his good fortune that his principal enemy, Attalus, was at this time in Asia, and that the other generals, Antipater, Perdiccas, and Leonnatus, remained faithful to him. It was, therefore, very easy to win the troops. With unexpected energy Alexander now took steps to secure his throne, so that the intrigues of his antagonists were made thoroughly futile.

In Alexander were united thoroughly different traits of character,

inherited from parents very unlike each other. His wild, passionate enthusiasm, with a tinge of fanaticism and fantastic chivalry, and a stormy leaning toward the extravagant, he inherited from his mother. From his father was derived that astounding and restless energy which only widened its aims at every success. He also developed the same power of cold reasoning, the same calm clearness in introducing all his plans, in selecting all his agents and deputies, and the same energy in executing whatever he began, that characterized Philip. In spite of his princely self-consciousness, he loved to be affable, mild, confiding, generous; yet he understood only too well, when it seemed to the interest of the state, to show fearful ferocity, crushing his antagonists with the same ease with which he had formerly treated them kindly. These last mentioned qualities were the ones that were most clearly displayed during the early stages of his government. The people were quickly won by his decided, yet generous, procedure. A most politic step was taken in freeing the property of his soldier-subjects from land-tax and other burdens. On his would-be rivals fell crushing blows. Attalus, in spite of his popularity with the troops and an alliance with Athens, did not venture to resist the authority of Alexander, even when Hecataeus appeared in Asia with an army under orders from Alexander to capture or kill him. Deserted even by his own father-in-law, Parmenio, he was easily gotten out of the way.

Alexander (Fig. 185) held firm to his purpose of opening the war against Persia as soon as possible. His shortsighted friends advised him to leave the Greeks to themselves, and to quiet the barbarian vassals by voluntary concessions. But Alexander, who considered it of the highest importance to hold the Greeks in subjection, proceeded at once to overrun their territory. In the autumn of B.C. 336 he crossed the Thessalian borders before the Greeks had made any preparations to receive him. Thus he was enabled to assume the position of his father, and by his moderation he won the good will of the Hellenes. The assembly of the Amphictyons at Thermopylae recognized him as generalissimo of the Greeks. His sudden appearance in Boeotia prevented any



FIG. 185. — Alexander the Great. Antique marble bust. London, British Museum. (From photograph.)

stirring in Thebes; and a deputation from Athens, headed by Demades, succeeded in renewing the treaty concluded with Philip. The assembly of the confederate states at Corinth confirmed the terms that had been made with Philip; and the king, having concluded his brilliant campaign, returned to Pella.

The rapid subjection of Greece was followed by a campaign against the troublesome barbarian neighbors of Macedonia. Alexander penetrated even beyond the Danube, where an army of the Getae was destroyed. Hence he turned southward, passed the territory of the Agrianes, and hastened up the valley of the Erigon, seeking to come to Lake Lychnidus, that he might quell an uprising of several Illyrian tribes who had occupied Pelion, a city commanding the Devol pass. But while Alexander was still before Pelion, he received news of the outbreak of a dangerous war in Greece. The ill feeling of the Hellenes toward Macedon, which was not destroyed by the occurrences of the autumn of 336, had been constantly nourished by the court of Susa. The Persians saw at last that Alexander was fully as much to be feared as his father, Philip. Through Memnon they received trustworthy information as to the true state of affairs. This general proceeded in the spring of 335, with 5000 mercenaries, to attack the Macedonians under Parmenio. He succeeded in driving them out of Asia, defeated Calas, who commanded for Alexander in the Troad, in the open field, and drove him back to Rhoeteum on the Hellespont. At the same time the Persians were making vigorous preparations by land and sea, and were trying in every way to win over the Greek states, and urge them on to war against Alexander. The desire for combat burned most violently in the breasts of the Theban democrats, who looked back with longing to the time of their greatness, and bore with ill-concealed rancor the double burden of the oligarchy and the presence of the Macedonians in their citadels. The report, too, was brought one day that Alexander had fallen in Illyria. Then the Thebans thought their time of deliverance had come. On a summer night (335) a band of Boeotian exiles returned from Attica, and called the assembly together. With enthusiasm they declared their independence, and elected Boeotarchs after their former custom. Without delay, the Cadmea was beset, and requests for aid sent to Athens and the Peloponnese. But the Macedonian garrison resisted bravely, and the Greeks delayed so long with the help, that at last Alexander burst upon them, as a storm from the north, having marched from Pelion to Boeotia in the incredibly short period of thirteen days. The Athenians now kept

within their walls, and the Peloponnesians beyond the Isthmus. On the contrary, the army of the king — 17,000 strong — was re-enforced by the old enemies of the Thebans, the Phocians and the Boeotians from Plataea, Thespieae, and Orchomenus. Nevertheless, the Thebans refused to capitulate. On the third day of the siege, the Macedonians, aided by an attack of the troops from the citadel, effected an entrance. The conquerors, above all the Phocians and Boeotians, spared no one, so that 6000 Thebans were slain in the streets which they defended step by step with the most desperate valor, while thousands of others only saved themselves by flight. With cool calculation Alexander now destroyed the proud city, so as to secure, by this one example, quiet during his absence in Asia. Only the Cadmea was left as a Macedonian fortress, and 30,000 Theban prisoners were sold into slavery (September or October, 335). Further violence seemed to Alexander unnecessary, and he graciously granted peace to the other cities. Athens, through the influence of Demades and Phocion, escaped with the banishment of Charidemus, who thereupon, joined by many other Hellenes, entered the service of the Persians, and carried on the struggle against Macedon beyond the sea. Alexander was now at leisure to enter upon the war against Persia.

With the beginning of the spring of B.C. 334 he passed over to Asia Minor. For the protection of his kingdom, and the maintenance of quiet in Greece, he left Antipater as his representative at Pella, with 12,000 infantry and 1500 cavalry. The Asiatic army consisted of 30,000 infantry and 5000 cavalry. We remark here that, strange as it may appear, many seem even now to suppose that the conquests of Alexander were effected by this one army. Though we cannot tell in detail how the losses occasioned by marches, battles, sickness, and the garrisoning of captured points were supplied, yet it is clear that reinforcements came continually from Macedon, and that mercenaries were gathered from many sides. The army of the king fell into three great divisions, namely, the national troops, the Greek, and the barbarian allies. The national troops were composed of 1500 heavy cavalry, 3000 hypaspistae, or guards, and 9000 phalangites. The last-mentioned were under the command of Parmenio, yet divided into regiments, each under leaders taken from the Macedonian nobility. Parmenio's sons, Nicanor and Philotas, commanded the hypaspistae and cavalry. From the barbarian vassal-territories numbers of light troops, mounted and on foot, followed the king; among whom the spearmen of the Paconian Agrianes, from the upper Strymon, per-

formed excellent service. From his Greek allies Alexander had, in addition to his corps of engineers, 7000 hoplites and 600 horsemen, besides a force of 1500 Thessalian cavalry. He had, further, 5000 heavy-armed Greek mercenaries. All these troops were under command of Macedonian officers, and the chief command of the whole heavy infantry devolved upon Parmenio. The fleet, under command of Nicanor, consisted both of Macedonian ships-of-war and Hellenic squadrons. With help of this fleet, the army crossed the Hellespont without difficulty.

The Persians had made a mistake in not expelling the Macedonians from Asia, sending their fleet to the Aegean, and beginning the war on the Hellespont. The satraps of Asia Minor seem to have confined their exertions to the securing of Greek mercenaries. From his camp at Arisbe, Alexander opened those magnificent campaigns which, within eleven years, changed completely the face of the east. At the very start, through the fault of the Persians, Alexander succeeded in forcing a battle. Memnon had advised them to desolate the land, avoid an engagement, render difficult the sustenance of an army, and send their fleet to attack Macedon, and stir up trouble in Greece. This good advice was neglected, and the satraps hastened with 20,000 cavalry and 20,000 Greek mercenaries to engage Alexander. The battle was fought in May, B.C. 334, at the river Granicus. Through serious tactical errors on the side of the Persians, the Macedonians were enabled to rout the Asiatic cavalry, and almost destroy the Greek mercenaries. On this occasion the excellence of Alexander's tactics was clearly manifest. After the manner of Epaminondas, he divided his army into an offensive and a defensive division, giving always the attack to the right wing. The two wings were, therefore, not only differently organized, but also differently armed. On the extreme right were placed masses of light infantry, bowmen, and the Agriani, who opened the fight. Next came the heavy Macedonian cavalry, led by Alexander himself, on which devolved usually the strongest charges. On the left side of this division the hypaspistae fought. The left wing formed the defensive division, and was composed of the heavy infantry, both the Greek troops and the Macedonian phalanxes. The left flank was covered by the excellent Thessalian cavalry, to whom the remainder of the Greek cavalry served as reserves. The lighter cavalry and the rest of the infantry were divided between both wings, according to circumstances.

The victory of the Granicus had a most encouraging effect on the

Greeks of Asia Minor, and a most depressing one on the Persians. The Persian commander of Sardis, Mithrenes, surrendered voluntarily his strong citadel, which henceforth served as a basis for Alexander's undertakings. Greek enthusiasm was nourished in every way; and by restoration of the democracy, and the abolition of tribute to Persia, Alexander bound this part of the Hellenic world firmly to himself. But still the Persian rule was not to be broken with one battle. At the siege of Miletus, which was captured only after the most strenuous exertions, Alexander saw the great difficulties he had to overcome. The arrival of a strong Persian fleet of 400 ships, mostly Cyprian and Phœnician, led him to send his own fleet home, lest it fall into the enemy's hands. Alexander's plan, as it now developed itself, was to overrun all the coast from Miletus to the Delta of the Nile, so as to render the Persian fleet ineffective, by shutting it off from the land, and especially so as to prevent communication with the disaffected Greeks. Thereby he also won an extended base-line for future operations against the interior provinces which he was bent on conquering. But this plan had this immediate disadvantage, that unhindered communication was left to the Persians with the mainland of Greece. The sturdy resistance that Alexander met at various points on the coast gave also to the Persian king repeated opportunities of hurling fresh masses from the interior against the small Macedonian army. In Caria, Alexander had to face serious difficulties. Memnon, who now had chief command of the forces of the Great King in Asia Minor, by land and sea, had fortified the important stronghold of Halicarnassus, and forced Alexander, in the autumn of 334, to begin a long siege. During the winter of B.C. 334-333, while Alexander was employed in subduing Lycia, Pamphylia, and part of Phrygia, the bold Rhodian was busy collecting, by means of Persian gold, new hosts of Hellenic mercenaries. In the spring of 333 he opened the campaign in the Aegean with 300 ships of war, having for his final purpose an attack upon Macedon, and the incitement of the Greeks to revolt. The Spartans were especially inclined to unite with Memnon, who proclaimed everywhere the autonomy of the Greek cities. He even gained possession of Chios, and Lesbos, except Mytilene.

Alexander did not suffer himself to be delayed by these occurrences. Committing to Antipater the task of opposing Memnon, he set off from Gordium on the arrival of fresh troops from Europe, in the spring of B.C. 333, and marched eastward with 26,000 men, infantry and cavalry. Soon he learned that his great antagonist, Memnon, had died of a pes-

silence in the camp at Mytilene. Thereby the Persians lost their best man in the Aegean, and their operations in the west became aimless and vain. Yet all their friends counted with perfect assurance on the success of the army which they knew Darius III. to be leading from Babylon. Alexander, too, wished for nothing more eagerly than a battle with these myriads of the east. From Tyana he passed, without resistance, through the 'Cilician Gates,' which lead from Cappadocia, over the Taurus, towards Cilicia. After he had passed Issus and had already arrived at the Syrian city of Myriandrus (November, 333), he ascertained that the Persian army was in his rear, near Issus. Darius had gathered, at least, 250,000 infantry, including 30,000 Greek mercenaries brought by sea from the Aegean, and more than 60,000 cavalry. He committed, however, the unpardonable fault of hunting up Alexander in Cilicia, instead of waiting to attack him as he passed over the mountains that separated the Cilician coast from Syria on the east. The Persians crossed Mt. Amanus, and reached Issus on the very day that Alexander arrived at Myriandrus. Their army was now stationed in the plain south of Issus, on the banks of the river Pinarus, where the ground stretches out *only* a few miles wide from the Gulf of Issus to the slopes of Mt. Amanus. In this position it was impossible to move heavy masses of men, and small chance of retreat was allowed in case of defeat. Alexander left them no time to recede from this position, but prepared for the attack on the very morning after he received news of their arrival. The issue of the battle remained for some time undecided, owing to the valor of the Persian cavalry and the Greek mercenaries. But when Alexander, leading in person an attack against the left wing of the Persians, routed it and the cavalry guard of Darius, the battle was irretrievably lost (Fig. 186). Darius himself commenced the pitiful flight. The fleeing Persians were cut down in great numbers by the pursuing Macedonians. Only the smallness of the Macedonian army prevented the total destruction of the Persian host. A part of the army, including several thousand brave Hellenes, collected again around Darius, who had fled towards Babylon. The main body of the Greek mercenaries that had supported Darius now fought their way through Phoenicia, and, in number about 8000 men, returned from Tripolis to Cape Taenarum in Laconia, one of the greatest recruiting places of Greece at that time. Four thousand others perished as robbers in Egypt. The news of the battle of Issus shook the confidence of the successors of Memnon in the Aegean, the admirals Autophradates and Pharnabazus, who were even unable to drive the Macedonian fleet from the sea.

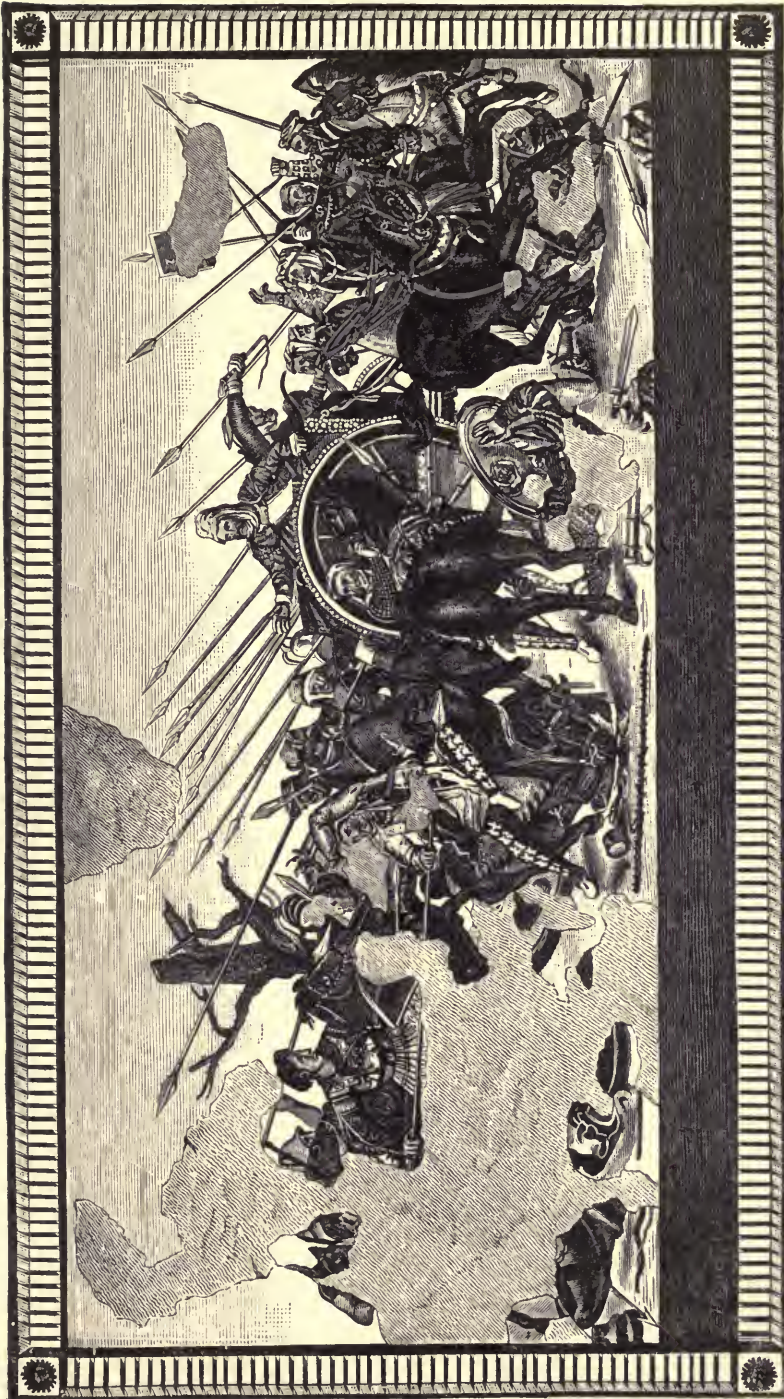

FIG. 186. — Battle of Issus. On a mosaic from Pompeii. (Naples, Royal Museum.)

Alexander, on his part, not caring to follow the Great King immediately, pursued his southward course in order to conquer the coast of Phoenicia, and weaken more quickly the Persian fleet. But here he met with an unexpected detention. The powerful island city of Tyre, the most important of all the Phoenician cities, refused to surrender. Thus Alexander was compelled, at the close of 333, to enter upon a siege, which, while it brilliantly displayed his soldierly perseverance and genius, detained him many months. His troops did not succeed in storming the town till midsummer of 332. The power of the rich and ancient Phoenician city was thus forever broken, and her importance passed over to Carthage. Alexander reaped his reward: the Persian fleet was dissolved, and for the most part went over to him. In spite of Tyre's fall, Gaza, in Palestine, which was in the hands of Batis, a faithful general of Darius, offered stubborn resistance to the Macedonians. Not until late in November was this place captured.

The conquest of the Delta of the Nile, which secured possession of all Egypt, was completed without a battle in the closing weeks of the year 332. The Egyptian populace, always restive under the Persian yoke, greeted the Macedonians as liberators; and Alexander understood well how to secure the sympathies of this ancient race by the nurture of their special interests and by entering into their peculiar religious ideas. Thus it is to be explained that the king, in the beginning of B.C. 331, visited the oasis of Siwah with its oracle and temple of the Egyptian Sun-God, Amun, called by the Greeks Zeus-Ammon, and allowed himself, after the manner of the old Pharaohs, to be consecrated as 'Son of Ammon,' or 'Son of the Sun.' It would also be of value in the approaching struggle for the Persian throne, if the Asiatic nations, who recognized in the Achaemenidae the earthly images of their deities, found in the Greek prince a man who stood in some mysterious relation to the gods. The Hellenes regarded the matter as a joke, but the Macedonians were rather displeased. This displeasure did not, however, become clearly visible until later, when Alexander began to place the Persians on an equality with the Europeans, and imitate the manner of living of an Oriental sovereign. More nearly in keeping with Alexander's character was the founding, on the Canopic mouth of the Nile, of the great city which still bears his name. One would err, if one ascribed to Alexander ideal aims for benefiting humanity in the truest sense. Yet with his large political plans he always united practical ideas, extraordinary administrative sagacity, and

creative force. He was not merely a mighty conqueror and a bold discoverer; he also aimed at organizing and governing the kingdoms he conquered. With his appreciation of the culture of the Oriental peoples, he desired not to force upon them Grecian authority, but, by means of Greek intelligence and activity, to infuse into their old system of satrapies new life and power. Of especial importance was the occupation of conquered lands with new colonies. Originally destined for military purposes, through their favorable situations they grew in nearly every instance to flourishing Greek or half-Greek cities, and were the centres from which Hellenic culture and civilization spread itself over a great part of the east.

With the subjugation of the Delta the plan Alexander had conceived at Miletus was finished. The Persian fleet had disappeared. Greece, except Sparta, was quiet. But heavy clouds were gathering in the east. As Alexander before and during the siege of Tyre had rudely rejected offers of peace made by Darius, new and extensive preparations had been constantly carried on in the Iranian and Turanian provinces of the Persian empire. With strong re-enforcements from Europe, Alexander now hastened, in the spring of B.C. 331, to leave Egypt. From Tyre he moved with his army of 50,000 men in rapid marches toward the Euphrates. Darius had determined to stake his all on one battle on the plains of the middle Tigris, so that Alexander had no difficulty in crossing the Euphrates at Thapsacus in July, in passing through northern Mesopotamia, or finally in crossing the upper Tigris, about seventy-five miles north of the ruins of Nineveh. From this point he began to seek the Persians, who had been encamped several weeks near the village of Gaugamela and the little river Bumodus, not far from the ruins of the old Assyrian capital. On October 1, 331, the decisive battle — known to history as the battle of Arbela — was fought, in which Alexander's army of 40,000 infantry and 7000 cavalry, after a long and arduous conflict, completely routed the monstrous host of the enemy, which, according to the least calculation, consisted of 400,000 infantry and 100,000 cavalry. The incapacity and cowardice of Darius, who himself set the example of flight, completely destroyed the confidence of the Asiatics. The Persian monarch succeeded in escaping to Ecbatana, but could not collect another army.

Babylon, the ancient metropolis of the Orient, fell without a blow into the hands of Alexander, who was welcomed with great enthusiasm. As he pressed farther eastward in the second half of

November, 331, Susa, the old and renowned residence of the Achaemenidae, became an easy prey. At this point Alexander was strengthened by fresh troops from the west, and, with an army of 44,000 infantry and 9000 cavalry proceeded, toward the end of 331, to attack Persis, the native seat of the Persians. Ariobarzanes, satrap of the district, boldly defended his native province with 40,000 soldiers, but fell in the defence of the Persian Gates, in January, B.C. 330. Alexander now descended to the glorious city of Persepolis, the ancient capital of Persis, and took fearful vengeance for the excesses of Xerxes in Greece. He wished, at the same time, to show the Persians that the day of the Achaemenidae was over, and that the monarch to be feared and served was now Alexander, "Son of the Sun." Persepolis was taken without a struggle, but was treated as a place captured by storm. The beautiful royal residence, on the marble terrace above the city, went down in flames, that were kindled, it was said, by Alexander himself.

In May, 330, Alexander started northward toward the Median capital, Ecbatana; but soon learned that Darius, who had now gathered 30,000 men, including 4000 Greeks, was retreating still farther to the east. So Ecbatana, the strongest fortress in the interior of the kingdom, fell without resistance into the hands of the Macedonians. Here Alexander halted for some time that he might have a secure basis from which to proceed to eastern Iran, and in order to arrange some important political and military plans. Ecbatana was chosen for the reception of the numerous treasures that had been acquired up to this time, which were estimated at 190,000 talents (over \$200,000,000). Parmenio remained at this point, which commanded all roads leading to the west, and was intrusted with supreme command in Media, having under him 16,000 infantry and 2000 cavalry. The army was also subjected to important changes. As the war of vengeance against the Achaemenidae was now concluded, Alexander sent back the Greek confederates richly furnished with presents, rightly judging them the fittest propagandists of his fame and politics. Greek mercenaries were, however, engaged in increased numbers, not hoplites, but light troops, both infantry and cavalry. The Macedonian national troops were distributed and organized purely according to military principles. After the departure of the Greek contingents, Alexander had at Ecbatana about 40,000 infantry and 8000 cavalry.

Alexander's purpose was now to prevent a protraction of the war, especially to forestall the struggle in the northern Iranian and Turanian

provinces. He sought, therefore, to overtake Darius, who was fleeing towards Bactria, in order to compel him to surrender. But so easy a conclusion of the war was not to be had. Alexander found, indeed, no resistance, as he passed eastward from Ecbatana towards Rhagae and through the Caspian Gates; but as he reached the western part of the province of Parthia, he received news that a decisive catastrophe had occurred in the Persian camp. Several of the Persian leaders had conspired to dethrone the incompetent ruler, to raise Bessus, then satrap of Bactria and commander of the Bactrian cavalry, to supreme power, and to continue the war in the eastern provinces. To this end the Great King was imprisoned at the village of Thara. When Alexander learned of this, he pushed forward in pursuit, in spite of the July heat, until all his army but the cavalry had to fall behind. One morning, at the head of a handful of horsemen, he came upon the Persians near where the modern Shahrud stands. The Asiatics fled wildly, but not until they had mortally wounded Darius, whose corpse alone fell into his enemy's hands. The hope of ending the war quickly and surely was thus at an end. Alexander, in whom almost all the Orient was ready to acknowledge the legitimate successor to the Achaemenidae, now assumed the right of avenging the death of Darius.

Alexander was careful not to press too recklessly after Bessus and his companions. He first collected his army, which had been much wearied and scattered through the forced marches of the pursuit. After considerable rest at the Parthian capital, Hecatompylus, he set out to conquer the districts along the southern shore of the Caspian Sea, and immediately north of Mt. Elbruz.

Alexander now received news from Antipater that the dangerous disturbances caused by Agis III. of Sparta had been quieted, though with much shedding of blood. In the summer of 331 Agis was compelled, by the movements of the Macedonian admiral, Amphoterus, to return from Crete, where he had been operating, to Laconia; and he now found, after the defeat of Darius at Gaugamela, that the supply of Persian gold was exhausted, through which alone he could hold together a force of mercenaries able to meet the Macedonians in the field. Yet of his own accord he now raised the standard of war, taking advantage of a severe defeat the Macedonian commander, Zopyrion, had suffered in northern Thrace, in the beginning of 330. With his mercenaries and militia, he routed the troops of the Macedonian Corragus, and called upon the Peloponnesians to join in the struggle. The Eleans, the Achaeans (except Pellene), the Arcadians (except Mega-

lopolis), answered his call; but beyond the Isthmus the Macedonian party kept even Athens from joining his standard. The resistance of Megalopolis delayed his progress so long that Antipater had time to come to terms with the Thracians; and then from the Macedonian and Greek allies to form an army of 40,000 men, with which he crossed the Isthmus. On the southern side of the plain of Megalopolis the battle was fought; and the army of Agis, 20,000 infantry and 2000 cavalry, was completely routed (June, 330). The Macedonians lost 3500 men, the Greek allies 5300, among them Agis himself. Agis's brother and successor, Eudamidas, concluded a treaty at once with Antipater, who granted favorable terms. From this time Sparta became completely subservient to the will of Alexander.

Outward quiet now reigned everywhere in Greece. Only at Athens there raged a violent war, not of arms, however, but of words. The foreign policy of the city was controlled by the Macedonian party, led by Phocion, supported by Aristotle, who, after the departure of his royal friend, in 334, had removed to Athens. He was now carrying on his scientific researches, assisted by collections continually forwarded him by Alexander, and, teaching in the Lyceum, had founded the school of the Peripatetics. Nevertheless, in the domestic policy the leaders of the old national party wielded a powerful influence. Just after the battle of Megalopolis, in 330, the people were assembled to hear a contest between Demosthenes and Aeschines. In the beginning of the year B.C. 336 Ctesiphon, a partisan of Demosthenes, had made a motion in the senate that Demosthenes should be presented publicly, in the theatre at the Great Dionysia, with a golden crown, as an acknowledgment of his unceasing activity for the good of the state. The motion passed the Boulé; but before reaching the assembly difficulties were met with, for Aeschines raised the charge of illegality, on the ground that Ctesiphon had neglected certain necessary formulas of the law. The matter came before the jury in August, 330. The trial proved to be a review of the political career of the two antagonists, and a contest between their opposing principles. The speeches of the two great orators on this occasion are preserved, though in a much revised form. The jury decided in favor of Demosthenes, and Ctesiphon was acquitted. The mortification of Aeschines at his defeat was so great, that he left Athens and went over to Ionia.

But the history of the world was not delayed by these victories of the national party at Athens. The number of Greeks that followed Alexander's army as hired troops, merchants, physicians, and artists

constantly increased. The charm of his tours of discovery, opening up lands seldom trod by the foot of a European, infused into the Greeks the same spirit that had once led them to spread over the coast of the Mediterranean. It awoke their bold daring, their romantic love of roving and adventure. No less did the representatives of Greek science, students of physics and geography, engineers and historians, whose pursuits were daily forwarded and benefited, sing the praise of Alexander.

Bessus now proclaimed himself the successor of Darius, under the title of Artaxerxes IV., and began to collect an army from Bactria, Sogdiana, and the wild Turanian tribes of the northern steppes. Alexander, first compelling the submission of Hyrcania, advanced eastward with 20,000 foot and 3000 horse, and during the second half of the year 330 overran the territories included within the modern Khorasan and Afghanistan, where he founded two 'Alexandrias,' which still survive as Herat and Kandahar. In the autumn, at Prophthasia in Drangiana, the dislike of the Macedonian officers for Alexander's growing haughtiness and Oriental tastes occasioned a conspiracy against his life, which he put down with savage cruelty. Parmenio, his son Philotas, and many others were put to death. Alexander's policy now became more and more cosmopolitan. The satrapies were mostly assigned to Asiatics, who received Macedonian or Greek lieutenants as military and financial administrators. From year to year, as we shall see, Alexander adopted other measures, having as their object the complete equalization and union of his European and Oriental subjects. With a breadth of view remarkable for his race and age, he desired to establish the colossal fabric of his world-empire, not upon the narrow though powerful base of Macedonian arms, but rather upon the surer basis of national acceptance and support.

In the course of the winter, which was spent at another new Alexandria, not far from the present site of Kabul, Alexander received strong re-enforcements from Media. Early in April, 329, he moved northward into Bactria over the mighty range of the Paropamisus (Hindu Kush), the march over which deserves to be ranked with the famous crossings of the Alps by Hannibal and Napoleon. Bessus proved quite as despicable an opponent as Darius, and fled, without a blow, across the Oxus into Sogdiana. Here he was betrayed by his own attendants into the hands of Ptolemy, commander of Alexander's advanced guard, who conducted him as prisoner to Zariaspa, or Bactra, the capital of Bactria.

The war with the organized forces of the ancient Persian empire was at an end; but now was seen the power of the rough native strength of the northern Iranian tribes and of the Turanian steppe-peoples, which, when once roused against the alien invaders, proved far more dangerous than had been the regular resistance of the incompetent Persian generals. Alexander crossed the Oxus, occupied Maracanda (Samarcand), the capital of Sogdiana, where he placed a strong garrison, and advanced as far as the Jaxartes, the farthest limit of the Persian kingdom, where he built and fortified Alexandria Eschate ('the farthest'). Here he received the alarming news that under Bactrian and Sogdian princes, especially the skilful Spitamenes, a general popular insurrection had broken out in his rear, which was spreading over the whole country, and threatening directly the troops in Maracanda. Spitamenes had destroyed a Macedonian detachment near Maracanda, and the jubilant insurgents fancied the invincibility of the invaders was gone. Surrounded by savage enemies, about 420 miles from Zariaspa, with only 23,000 foot and 4000 horse, cut off from all connection with his troops in Bactria, Alexander did not lose courage. He had first to secure the frontier against a great host of Scythians assembled on the right bank of the Jaxartes. Under the protection of his artillery, which operated here for the first time in ancient military annals in the open field,¹ he crossed the mighty stream, and by a skilful union of his bowmen and chasseurs with the cavalry, won a brilliant victory. Then he hastened madly southward, relieved at the last moment his comrades in the citadel of Maracanda, revenged the destruction of the Macedonian detachment by laying waste with fire and sword the central district of Sogdiana, and returned toward the end of the year 329 to Zariaspa. While wintering here he condemned Bessus to death. Preparations were made for the prospective Indian war, and the king found his army increased by strong re-enforcements from the west to 34,000 foot and 6000 horse. With these troops the Sogdian popular insurrection, which had burst out anew, was crushed completely during 328 and the early part of 327, five strong columns operating concentrically from the Oxus toward Maracanda against the Asiatics. During the halt at Maracanda, Alexander affixed an indelible stain to his name by the murder, at a drunken feast, of the trusty lieutenant Clitus, who had saved his life at the Granicus.

Alexander now turned his attention personally to taking several

¹ Except in an earlier campaign of Alexander himself, in a battle against the Illyrians near Pelion, in B.C. 335.—ED.

castles of Asiatic princes, situated on high mountain peaks, which were forced to surrender mainly by the Macedonian artillery. Gradually the resistance died out everywhere, especially after Spitamenes was murdered by his own wife. Alexander himself, early in 327, captured an almost impregnable fortress, called the Sogdian Rock, in the south-eastern hill country. Among the captives was Roxana, daughter of the Bactrian prince Oxyartes, the most celebrated beauty of the time, whom Alexander made his bride.

At the close of the Sogdian war, Alexander returned to Zariaspa, there to remain till the end of spring, 327. The next task before him was the Indian war. It had been the policy of the first Achaemenidae to control the whole course of the Indus to the Delta. But Alexander's plan went far beyond the recovery of the line of the Indus. With the Greek ignorance of the real extent of Asia, he conceived the wonderland of India to be a comparatively small territory, and hoped by its conquest to obtain for his new empire a frontier on the ocean. Political alliances were made with powerful chieftains of the Panjab, especially with Mophis of Taxila. Since 328 new enlistments in Greece and elsewhere in the west, great recruitings in Macedonia, and other preparations, were in progress, in order to strengthen the field army; but especially the king made the bold step of taking Asiatic troops into his army. Since 328 men had been enlisted in the countries south of the Hindu Kush, and now Bactria and Sogdiana had to furnish 30,000 men. Not only could Asiatic cavalry and light-armed troops be utilized under European officers, but these enlistments secured quiet in the provinces of the north, which had been conquered with so much difficulty. At Zariaspa was discovered a conspiracy of the royal pages, who were disgusted by the growing orientalization of the court, and especially by Alexander's requirement of the *proskynesis*, or bending of the knee, a usage abhorrent to the free Greeks and Macedonians. All suspected of participation in the plot were put to death or punished with terrible severity. Among the victims was Callisthenes of Olynthus, the nephew of Aristotle, himself a celebrated philosopher and rhetorician.

The wretched scenes of Zariaspa quickly retired into the background after the opening of the Indian campaign. Toward the end of the spring of B.C. 327, there were collected, on both sides of the Hindu Kush, about 120,000 men, among them more than 40,000 European warriors. With 90,000 foot and about 16,000 horse, the king set out from his colony, Alexandria, for the Panjab. The mountain tribes

were subdued by a series of brilliant operations, which, however, required considerable time. Not until late in the winter of 327–326 did Alexander reach the Indus, here to crown his successes by storming the rock fortress, Aornus. Early in the spring of 326 the Macedonian army entered the wonderland of India. Enjoyment of the new and strange soon gave way before the hardships of the Indian rainy season, and before the murderous battles and hitherto unknown terrors of war. In the war against the old Rajah Porus, the enemy of Mophis of Taxila and Alexander, a great battle was fought, on the left bank of the Hydaspes, in which the Macedonians were opposed by 30,000 foot, 4000 horse, 300 war-chariots, and 200 war elephants. The elephants, especially, played havoc among the Macedonians until the latter learned how to avoid their charge. Finally the victory fell to Alexander, who, by generous treatment, turned the proud Porus from an active enemy into a faithful ally. From the Hydaspes, the army moved farther eastward, neither the swollen streams of the Panjab, nor the brave resistance of the inhabitants, being able to check Alexander. When the troops reached the Hyphasis, and received more exact information of the extent of India, and of the vast armies and number of elephants which its kings could put in the field, they positively refused to go farther. Alexander, prudently, did not force the issue, but turned back, after marking the limits of his conquest by the erection of twelve colossal altars.

Turning westward, the Macedonians reached the Acesines (Chenab) in September. There a good fleet was built, on which the king led to the Indian Ocean a large part of his army, proceeding by way of the Acesines, the Panchanada (Panjnad), and the Indus, while strong columns, moving parallel with the fleet on either side, crushed all opposition.

The Macedonians reached, finally, the southernmost part of the Indus delta, Pattalene. Information from countries between the Kabul and Ecbatana of numerous disturbances and deeds of violence of bad governors, who, supposing that Alexander would hardly return from India, had wickedly misused their opportunity, induced the king to send, in July, 325, the most reliable of his confidants, the universally esteemed Craterus, with 30,000 men, to restore order in the eastern countries of Iran. Alexander, instantly recognizing the extraordinary commercial importance of the Indus delta, exerted himself to create here a basis from which the seaworthy vessels of his fleet—over 100 ships with 5000 men and some artillery, under his friend,

Nearchus—were to venture, later, upon a voyage of discovery from the Indus to the mouth of the Euphrates. The king himself began, with 60,000 men and a large number of camp-followers, toward the end of August, 325, from Pattala (at the mouth of the Indus) his return to Persia. On December 9, 325, the fleet arrived, without serious loss, at the mouth of the Carmanian river Anamis, near the city Harmozia (Minab). But Alexander fared much worse. His march led through the desert of Gedrosia, an uninhabitable waste of reddish drift-sand. The nature of the country, the glowing heat, the fearful sand, which, at the slightest breeze, filled the air and penetrated the eyes, ears, and nostrils, gradually, also, want of water and provisions for the army, caused fearful sufferings. When the army, after sixty days of horror, reached the pleasant country of the Gedrosian capital, Pura, half the soldiers and nearly all the camp-followers had perished. The march, after this, led through fertile and well-watered regions. At the beginning of December, 325, Alexander halted for a long rest in a Carmanian city, probably Salmus. Here he was rejoined by Craterus and several officers of lower rank from Ecbatana, and stood again at the head of 60,000 men. Here, too, he reopened connection with his fleet. Setting off, January 24, towards Susa, the king appeared everywhere as a fearful judge, revenging with pitiless severity the many wanton deeds which Asiatic and western governors, magistrates, and officers had committed against his subjects during his absence in India. Harpalus, the general director of finance, who had misused his position in the most reckless debauchery, and had stolen colossal sums from the treasury, fled with 5000 talents and 6000 mercenaries to Greece.

The return to Susa was signalized by a grand festival, at which Alexander made presents to the soldiers and officers in the most generous manner, and at the same time sought to put into effect the plan which he cherished and symbolically indicated by numerous marriages of prominent Greeks and Macedonians with young women of the best families of the Persian nobility; namely, the blending of the Asiatics and the Westerners. The Asiatic troops were now directly incorporated into the organism of the army. However expedient this was, the Macedonians took it very ill, because they felt that they would, by these innovations, be less indispensable to Alexander than before. This time even the veterans of the infantry grumbled at the king. When the latter had, toward the end of April, 324, left Susa, and led the army up to the city Opis, an important crossing-point of interior Asiatic highways on the middle Tigris, and from here proposed to send

home with honor a great part of the oldest warriors, a dangerous mutiny broke out in July, 324, among the Macedonian troops, who foolishly saw in the king's action a base humiliation. In this struggle with his veterans, Alexander, by his resolution and great art in handling soldiers, won the victory. There was a grand reconciliation; then 10,000 veterans, the oldest warriors, who had shared all the campaigns from the Granicus on, were selected out to be sent home, and covered with rich presents, as well as with splendid and valuable marks of honor. Craterus was to accompany them, and to take the place of Antipater as regent of Macedonia, while the latter was to lead large re-enforcements into Asia.

Alexander now pushed forward vigorously magnificent plans for the government and extension of his already immense kingdom, of which Babylon was selected as capital. Only the sudden death of the most intimate friend of his youth, the general Hephaestion, cast gloom over the splendor of his court at Babylon. New naval and land armaments were prepared. Numerous embassies came from the most various parts of the west, Carthage and Rome not excepted. For the short span of time still granted to him, Alexander's dream of universal dominion had become a brilliant reality. It seems probable that the object of his next expedition was to explore and conquer the Arabian peninsula, which projected unknown and unsubdued into the midst of the great empire. Toward the end of May funeral ceremonies, splendid beyond all conception, were held in honor of Hephaestion; and already the departure of Nearchus's fleet and of the army for the south was definitely determined on, when the king, fearfully exhausted by labors, hardships, and mental excitements of every kind, took a fever in consequence of excessive intemperance, which in a few days proved fatal. His death is usually placed on the 8th or the 11th of June, B.C. 323. It is possible that it occurred before the end of May.

Alexander left no legitimate heir to the throne. The generals, headed by Perdicas, to whom Alexander had given his signet-ring on his death-bed, wished to reserve the empire for the expected child of Roxana; the soldiers, on the contrary, greeted as king Philip Arrhidæus, the illegitimate half-brother of Alexander.

Finally, Alexander's former private secretary, the Greek, Eumenes of Cardia, the most attractive figure among the commandants, brought about an adjustment. The empire was to be jointly ruled by the two claimants. Antipater was to be the commander in Europe, Craterus regent, Perdicas marshal of the empire. Among the governors far

the most prominent in the following period were the adjutant-general, Ptolemy, son of Lagus, who received Egypt, and Antigonus, a shrewd politician of great ambition and bold decision, to whom was again assigned Greater Phrygia, where he had held sway since the beginning of 333, without taking part in the eastern campaigns. The latter received now from Perdiccas the command to put Eumenes in possession of Cappadocia, which had hitherto been for the most part independent, and of the Pontic coast belonging thereto. The prince Leonnatus, an especially trusted friend of Perdiccas (who now assumed the regency), was to take part in the campaign, then take possession of Hellespontine Phrygia, while Thrace was assigned to the adjutant-general Lysimachus. The provinces east of the Tigris remained in the hands of their present possessors. As many of the governors as were present in Babylon remained together till winter, to meet again, as a rule, only on the battle-field. The whole army greeted the birth of the boy Alexander, who was born to Roxana; and celebrated in common the funeral of the great king, whose body was taken to Memphis in Egypt for burial, and later removed to Alexandria.

The governors showed little inclination to obey the commands of Perdiccas, who, with Eumenes as his principal lieutenant, became involved in quarrels with Antigonus, Ptolemy, Leonnatus, and Antipater. In these quarrels began the bloody era of the Diadochi, or 'Successors' [of Alexander]. Antipater, in turn, found his hands fully occupied by an energetic and for a time successful revolt of the Grecian states.

Two ordinances of Alexander had caused great resentment in Greece. After his return from India the king had (in the first half of 324) required the Greek states to pay him 'divine honors,' which practically meant to introduce in their official intercourse with him a ceremonial corresponding to the oriental. Then Alexander had a decree proclaimed at the Olympic games of the same year, commanding the Greek states to receive back the fugitives who amid the storms of the past decades had been expelled from numerous cities. Alexander, who excepted from his rule only Thebans, murderers, and robbers of temples, hoped thereby to strengthen the Macedonian party by many thousands, while the communities had to fear, as the result, the worst confusion within their walls, and a flood of suits at law. The protest which the Athenians made at Babylon against the return of the exiles, Alexander seems to have respected as far as Attic possessions were concerned. Possibly it was because just at that time Demosthenes had, through a base intrigue, been expelled from Athens. The treas-

urer Harpalus had, on his flight from Ecbatana (324), escaped with 30 ships, 6000 soldiers, and 5000 talents to Attica. On the sensible advice of Demosthenes the citizens at first refused to receive him; and not until he had sent his mercenaries to Taenarum was he admitted to the city, bringing with him 700 talents. Some foolish politicians, supported even by Hyperides, were induced by his bribes to begin an untimely agitation, the object of which was to raise an insurrection against Alexander. This Demosthenes strongly opposed, and thereby ruined himself completely with the radicals and with Hyperides. When a demand came from Queen Olympias and Antipater that the Athenians should deliver up Harpalus, Demosthenes caused no attention to be paid to it. On the contrary, Harpalus was to be arrested, and his money kept on the Acropolis for Alexander. The treasure was counted, and it was found that only 350 talents remained. Demosthenes proposed to recover the other half from the receivers, while the Areopagus was to institute investigations of the bribery, with a view to punishment by the dicasts. Harpalus, who not long after escaped, met his death in Crete. In Athens, however, where the investigations continued, the resentment of the radicals against Demosthenes brought it about that every possible slander against the great man found credence. By some he was called a 'hireling of Alexander;' others regarded him as bribed by Harpalus, because he had not prevented his flight. Finally the Macedonian party, supported by the moderate radicals, drove him from Athens, as a propitiatory sacrifice, to the especial joy of the Macedonian rulers at Pella and Babylon. The Areopagus, in its report of the investigation, at the end of the year 324, declared Demosthenes, among others, convicted of bribery. Of real proof, however, there was no trace; nor was there afterwards in the trial before 1500 dicasts, where the fury of the hostile advocates won the victory. Demosthenes was declared guilty, and was sentenced to pay a fine of fifty talents. As the sum was far beyond his ability to pay, he was arrested, but escaped after a few days, and went as an exile to Aegina and Troezen.

When a few months later the news of Alexander's death reached Greece, it went like an electric shock through all the members of the Hellenic world, among whom new hopes of freedom awoke. The Rhodians at once expelled the garrison which had been on their island since 332; and their historic and mercantile greatness dates from that time. But the wildest fury of the storm raged through the Peloponnese and the mainland of Greece, and Athens naturally became the centre of the

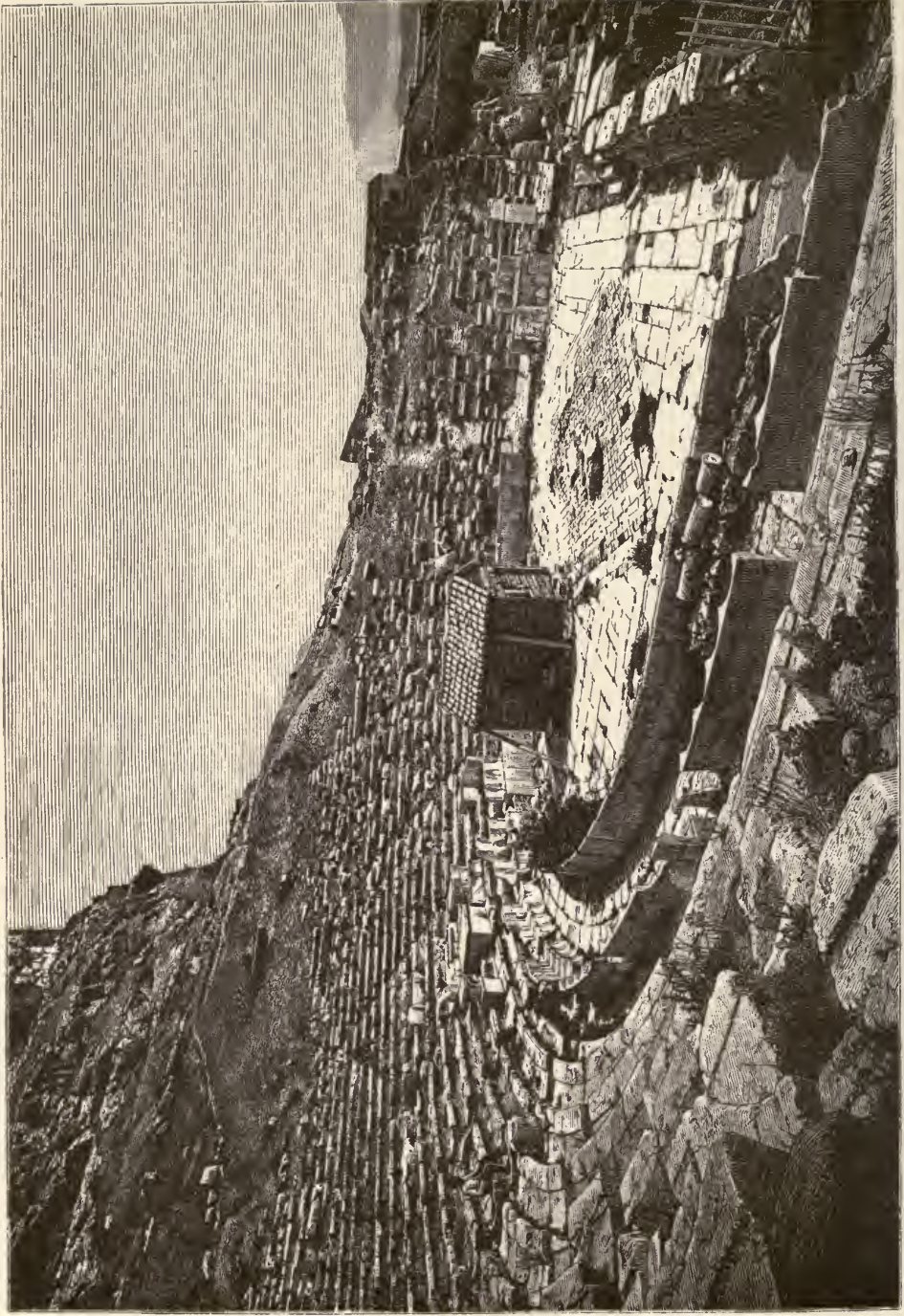

Theatre of Dionysus at Athens. (From a photograph.)

new commotion. Materially the city was now in good condition. Lyeurgus, who had until the summer of 326 directed the finances of Attica, had been able to raise the yearly revenues of Athens to 1200 talents. These means had been excellently managed. Among the public works of Lyeurgus, the rebuilding of the theatre of Dionysus (PLATE XXI. and Fig. 187), which was brought to a successful end in 330, and the completion of the great naval arsenal of Philon, were especially noteworthy. But unfortunately, at the critical moment, there was no statesman who possessed the insight to observe the inevitable



FIG. 187. — Marble seat of the high-priest in the theatre of Dionysus at Athens. London, Brit. Mus. (From photograph.)

dissolution in Asia, and the power to hold the Hellenes in check until the favorable moment to strike. The Macedonian party in Athens had now lost the reins from their hands. Lyeurgus died in the year 324, Demosthenes was banished, and the radicals, with Hyperides at their head, took control. The general Leosthenes, a friend of Hyperides and Demosthenes, collected in Asia Minor, in the year 324, many Greek mercenaries that had been dismissed by the satraps at Alexander's command on his return from India, and led them to Taenarum, where he kept together about 8000 men. When the announcement of Alexander's death was officially confirmed, Hyperides, in the summer of 323,

put through a motion in the Athenian assembly to open war against the Macedonians, and to call upon all the Hellenes for help. Alexander's former instructor, the aged Aristotle, was forced by a charge of 'atheism' to leave Athens, and remove to Chalcis, where he died toward the end of the year 322. It was decreed to make the most extensive military preparations, to turn the money of Harpalus on the Acropolis over to the war fund, to invite the co-operation of all the Hellenes, and give the chief command to Leosthenes. The Aetolians at once made an alliance with Athens, and Leosthenes hastened to open the war. As Boeotia and Euboea were in possession of the Macedonians, he led his 8000 mercenaries from Taenarum to Aetolia, enlisted 7000 of the wild mountaineers of this district, then hastened through Locris and Phocis, and occupied Thermopylae. Thence he moved southward again with a part of his army, united, in Boeotia, with 7000 foot and 500 horse of the Athenians, and routed at Plataea a Boeotian and Euboean army, re-enforced by the Macedonian garrisons. He now hastened back to Thermopylae, in order to oppose Antipater, who was hastening to the assistance of his Greek partisans. The Macedonian general could, at the moment, command only 13,000 foot and 600 horse, with which he marched in all haste to Thessaly. The Thessalians obeyed his summons; but when they saw the Athenian ensigns at Thermopylae, they went over, under the lead of Meno, without hesitation to Leosthenes and in a battle at Heraclea before the pass Antipater was so utterly beaten that nothing remained to him but to throw himself into the fortress of Lamia, where Leosthenes besieged him with great energy. This victory decided most of the Greek states to join the Aetolians and Athenians. The Athenians recalled Demosthenes in the most honorable manner toward the end of the year 323. Meanwhile the Greek army before Lamia grew to 30,000 men. Antipater was reduced to great straits. He was not even strong enough to avail himself of the opportunity offered by an untimely furlough *en masse*, which the homesick Athenians took in order to refresh themselves by the sight of their beautiful city. Antipater wished to make peace; but the Greeks, in their foolish desire for revenge, demanded his unconditional surrender. And now, as the evil star of Greece would have it, Leosthenes fell in a skirmish early in 322. For some time, however, fortune remained true to his successor, the able Athenian Antiphilus. Leonnatus, governor of the Hellespontine Phrygia, with 20,000 foot and 2500 horse, advanced to relieve Antipater, but was opposed by Antiphilus with 22,000 foot and 3500 horse at Melitea, completely defeated in a cavalry fight, and lost his own life.

During this battle, however, Antipater broke out from Lamia, drew to himself the troops of Leonnatus, and retreated to Tempe. While the Macedonian fleet drove the Attic from the sea, Craterus appeared with his veterans in Macedonia. Antipater was now able to lead 40,000 hoplites, 3000 light-armed troops, and 5000 cavalry, in the summer of 322, to Thessaly, to whom the Greeks could at the time oppose only 25,000 foot and 3500 excellent cavalry. In the battle of Crannon (on the anniversary of Chaeronea), the Macedonians won, indeed, only a half success. But Antiphilus and his colleague Meno could no longer control the timidity of the remaining leaders. When the Greeks proposed peace to their old Macedonian master, Antipater expressed a willingness to make terms with the individual states, but not with the allies collectively. Thereupon the Greek army dispersed; and when Antipater offered grace to all who would at once submit, the Greeks hastened to make terms with him. Everywhere, however, the harsh rule of the oligarchy, who were favorably inclined to Macedon, was restored. Only the Athenians, from whom Antipater demanded the surrender of Demosthenes, Hyperides, and other leaders, and the Aetolians still hesitated. Athens could have got better conditions, had it been possible to bring the people to bear themselves as bravely as after Chaeronea; for a long siege of the city, in view of the increasing complications in Asia, was not to the interest of Antipater and Craterus. But this time the citizens had lost both their courage and their senses. They threw themselves into the arms of Demades, and sent him, with Phocion and Demetrius of Phalerum, into the hostile camp at the Cadmea, where Antipater demanded that they yield themselves to his discretion. The leaders of the national party now fled in all haste from the city, which now lost forever its commanding position among the great cities of the ancient world. The Athenians retained only their own district, losing Oropus to the Boeotians, and Samos to its old inhabitants. All citizens who did not possess property amounting at least to 2000 drachmae (\$380) were henceforth to be deprived of all political rights. There were 12,000 of these, and only 9000 active citizens remained. Finally a Macedonian garrison was placed in the fortress of Munichia (September 16). In Athens, Phocion and Demades were now in authority; and the latter lent himself to the effort to have sentence of death pronounced against Demosthenes, Hyperides, and their associates, for 'high treason.' Macedonian hangmen and Greek scoundrels began a chase after the outlaws. Hyperides was seized on Aegina, and murdered, October 5, at Cleonae. Demosthenes took poison on the

island of Calauria, October 12, 322. Only the Aetolians held out bravely. Their valiant resistance was to be suppressed by 30,000 foot and 2500 horse, who advanced against them toward the end of the year 322. The severe winter had already caused great distress to these, when Antigonus came as a fugitive into the Macedonian camp, and Antipater and Craterus saw it necessary to concentrate their strength for the conflict with Perdiccas. The favor of fortune, which Athens had trifled away, thus secured for the Aetolians favorable terms of peace.

The war broke out with fury in the spring of 321,—Perdiccas and Eumenes against Ptolemy, Craterus, Antipater and Antigonus. Craterus fell; but Perdiccas was defeated, and then slain by his own officers. His troops went over to Ptolemy. Eumenes was outlawed; and the confederates, now joined by Seleucus, former commander of the royal pages, made a fresh division of the provinces, at Triparadisus in Syria, in the autumn.

Seleucus received Babylonia; Ptolemy retained Egypt. Antipater, who was chosen regent, escorted Roxana and the young sovereign to Pella. Dying in 319, he left the regency to Polysperchon. Antigonus in Asia Minor was at this time the most powerful of the generals.

The era of the Diadochi, or of the 'Successors' of Alexander, is now ushered in.

CHAPTER XVII.

THE AGE OF THE DIADOCHI.

HOWEVER confused appears the turmoil of war, which until the end of the fourth century fills the countries from the Ionian Sea to the Panjab, it is still easy to recognize its distinguishing characteristic. The conflict was between the representatives of imperial unity and those of dismemberment. After Antipater's death the blows of the great rulers were directed more heavily against the race of Alexander and against the champions of royal rights. When all these were finally overthrown, the idea of the empire was still so strong that the most powerful opponent of the old order, the ambitious Antigonus, could now lay claim, though indeed only on the ground of his superior power, to supremacy over the other rulers. After 315 the arms of the rest of the great Diadochi were turned, therefore, against him. But not until 306 had the disintegration gone so far that the most powerful governors assumed the royal titles, and not until 277 did a comparatively permanent system of great Hellenistic powers arise on the soil of Alexander's empire. The wars and struggles with which this long period was filled were, in a way, actually beneficial to the Oriental peoples, compelling the kings and generals to gain support by consulting more closely the interests and sentiments of their subjects, and hastening the amalgamation of European and Asiatic in the provinces of the East. In Greece, on the other hand, the incessant warfare of forty years had consequences most evil and disastrous. Here the conflicts were always most stubborn, most prolonged, and most bitter; for the fortresses and harbors of the country, and its supplies of mercenaries, were of great importance to the contending kings, while the furious party spirit in the cities was ready to blaze up in violence at the slightest excuse. A general had only to announce it his purpose to 'free' Greece from foreign domination to secure everywhere support for his own cause, which, if successful, proved, of course, only a different tyranny. Poverty and social and political demoralization spread irremediably; in many places tyrants arose, supported by ruthless guards of mercenaries, and misery and desolation covered the face of Hellas.

The beginning of the great commotions was made after Antipater's death, by his son Cassander. Embittered by Polysperchon's appointment as regent, he made a secret alliance with the Macedonian commanders and with the oligarchic leaders in Greece. In order to maintain the expected conflict, Polysperchon resorted to the most desperate measures, to which the imbecile 'King' Philip had to lend his name. He entered into intimate relations with the queen-mother, Olympias, and sought to ruin Cassander's position in Greece by a decree (May, 319) which restored to the Hellenic cities freedom and autonomy, and at the same time called upon the Greek democracy, in the name of the crown, to overthrow the oligarchy, put their leaders to death, and confiscate their estates. Thus began, under the strong co-operation of the men banished a few years before by Antipater, a series of outbreaks of the democratic spirit of revenge. In Athens the constitution was established as it had been before the peace of 322. The surprise of the Piræus (summer of 319) by Nicanor, Cassander's general in Munichia, which was made possible by the supineness of Phocion, roused the commons to such fury that Phocion, with several of his party associates, was accused of high treason; and when Polysperchon and King Philip entered Greece with their army to give emphasis to their decree of blood and 'freedom,' sentence of death was passed upon the aged man and four of his friends, and was carried out (May, 318). Immediately afterwards Cassander appeared in the Piræus, supported by Antigonus with thirty-five ships and four thousand men. Polysperchon continued the restoration of the democracy in the Peloponnese, until the resistance of Megalopolis forced him to a long and unsuccessful siege. Meanwhile Cassander made considerable progress, conquered Aegina and Salamis, and reanimated his party in Greece. When Polysperchon, after a defeat of his fleet at Byzantium, thought that an invasion of Europe by Antigonus was to be feared, and left the Peloponnese again, his power in Greece collapsed. The Athenians made, in November, 318, a tolerable peace with Cassander. They lost Salamis, and Macedonian troops remained in Munichia and Panactum; but the democracy was to continue, only the number of active citizens was limited to those who could prove a taxable property of at least one thousand drachmae. Besides, the Athenians were obliged to appoint as regent Demetrius of Phalerum, a friend of the deceased Phocion,—an excellent administrator, though of dissolute private life, who restored the prosperity of the community to an astonishing degree.

In Macedonia, Olympias got the upper hand in 317, and slew

Arrhidaeus, his wife, Eurydice, and many of their adherents; but was herself soon overthrown and captured by Cassander, who permitted the families of those she had murdered to put her to death. Cassander now married Thessalonica, a half-sister of Alexander, and began to think of putting aside the child of Roxana, and seizing the crown for himself. Antigonus now possessed the sovereign power over nearly all Asia. But his arrogance roused against him, in 315, a powerful coalition, which included Ptolemy, Seleucus, Cassander, and Lysimachus, governor of Thrace. Antigonus allied himself with Polysperchon, and proclaimed that the cities of Greece should be free, autonomous, and without garrisons. Ptolemy issued a counter proclamation to the same effect, and the internecine strife in the peninsula broke out afresh. The struggle dragged on in Greece and Syria without decisive results until 311, when the exhaustion of all parties caused the conclusion of a peace. The right of Roxana's son, Alexander, to the throne was once more recognized, and the present state of possessions maintained; but Seleucus was given up by his friends, the supremacy of all Asia conceded to Antigonus, and the complete autonomy of the Hellenic states declared.

This treaty was really only a truce. Cassander hastened now to rob the eastern world of the symbol most dangerous for him. Before the autumn of 311 he caused Roxana and her son to be murdered at Amphipolis, after the tried Macedonian and Persian custom. Antigonus was not able to take revenge; for it seems that he was engaged in an unsuccessful war with Seleucus, which led to his renunciation of the East in the latter's favor. Meanwhile the shrewd Ptolemy began, after the occupation of Cyprus (from 310), to carry out the article of the peace which declared the freedom of the Hellenes. Polysperchon, probably not with Antigonus's previous knowledge, invited to Greece the prince Heracles, a son of Alexander the Great by Memnon's widow, Barsine, and, with the help of the Aetolians, raised an army of twenty thousand foot and one thousand horse against Cassander. The latter again displayed his old art as a diplomat. To ward off the new danger, he bought Polysperchon with one hundred talents and great promises. The old general became a common ruffian, murdered in 309 the unhappy Heracles, the last male scion of the old royal house of Macedonia, and entered Cassander's service.

Ptolemy in 308 appeared in Greece, and won some successes. He was, however, soon called away to Africa. Antigonus now determined to win the Greeks to his side in the great struggle which he saw

impending, by driving out their Egyptian and Macedonian garrisons. With his son Demetrius, a young prince of great energy and romantic desire for action, and in the highest degree enthusiastic for everything Hellenic, he sent, in the spring of 307, two hundred and fifty ships of war, and abundance of money, from Ephesus to Athens. This city, which, with its country districts, still numbered twenty-one thousand citizens, ten thousand resident aliens, and 400,000 slaves,¹ and whose commerce had taken a new growth since the East had been opened by Alexander, enjoyed now, under the direction of Demetrius of Phalerum, brilliant prosperity. His able administration had again brought the revenues of the state to twelve hundred talents. Besides, Athens was, to her great material advantage, the much visited seat of philosophical studies. Even then the fame of Theophrastus of Lesbos, who, after the death of Aristotle, was the head of the Peripatetic school, collected about two thousand pupils. There was a parallel development in literature, especially in comedy. The especial aim of Attic comedy was now to put upon the stage clever pictures from social life, with increased prominence of the erotic element and of domestic intrigue, with witty, delicately caricatured types from the life of contemporaries, from the stiff *nouveau riche* and the dissolute or braggart captain of mercenaries to the spoiled scoundrels among the trusted slaves of the house, and the hetaerae. This form of art owed its development especially to two highly gifted poets. Philemon, a native of Syracuse, from about 329 resident at Athens, charmed especially by abundant and animated action, and by a delicate play of intrigue in his comedies. He first developed the art in the new direction. The brilliant rival of Philemon, who died at a great age in 263–262, was the Athenian Menander, son of the general Diopithes. Born in 341, contemporary and friend of the philosopher Epicurus, not less intimately connected with Theophrastus and Demetrius of Phalerum, a brilliant man of the world, with considerable means and a fertile mind, Menander, who died at the age of fifty-two, displayed a vast productiveness, making his first appearance before the public in 321. His art, which renounced personal satire and such means, made the action less prominent, and culminated in a deeply laid and perfectly sustained characterization of persons, did not win its proper place in the estimation of the Greeks until after his death. The elegance of his dialogue, the grace and smoothness, the charming fidelity and practical wisdom, which were shown in his pro-

¹ These are the figures commonly given. The number of slaves is probably grossly exaggerated. — Ed.

ductions, made his comedies afterwards the favorite reading of educated Romans and Greeks until the extinction of ancient life (Fig. 188).

The workshops of the sculptors, and of painters also, — conspicuous among whom, after the death of Apelles, was Protogenes of Caunus, — were overwhelmed with orders. Athens might be still considered, among the cities of Greece proper, that one where Greek life displayed the intellectually freest and most elegant forms. But everywhere the only guaranties of even partial security were now flattery and thinly veiled servility before the military despots. The Athenians, who had formerly been so chary with their marks of civil honor, are said to have erected three hundred and sixty statues to Demetrius of Phalerum.



FIG. 188.— Menander. (After Visconti.)

Prince Demetrius (Figs. 189–191) soon overthrew his namesake of Phalerum, and proclaimed to the people of Athens, now allied with his father, complete restoration of their ancient democracy and autonomy, and bestowed upon them rich gifts of corn, and building-material for 100 ships of war. The statues of the Phalerean were overturned,



FIGS. 189, 190. — Coin of Demetrius Poliorcetes. Niké blowing a trumpet, a trophy staff in the left hand, standing on the prow of a ship, on which the waves of the sea are indicated below. She is proclaiming the victory won by Antigonus and Demetrius at Cyprus in B.C. 306. Rv.: ΔΗΜΗΤΡΙΟΥ ΒΑΣΙΛΕΩΣ. Contending Posidon swinging his trident, protecting his outstretched left hand by a chlamys. Silver. (After Friedländer and v. Sallet.) [This coin, on the obverse, appears to represent a statue of Niké, which was set up by Demetrius on the island of Samothrace. Important fragments of the statue were discovered on the island, and have been brought to France. They are now in the Louvre. — ED.]

melted, and for especial mockery worked into utensils for household use. It was the turn of the new benefactors to be honored, and Attic servility accomplished wonders. To the ten old phylae of Attica two new ones were added, Antigonis and Demetrias. Both princes were represented as 'saviours' in gold or gilded bronze in quadrigae; their

statues were placed by the side of those of Harmodius and Aristegiton, and an altar was erected to them. Demetrius was soon called away by his father to the war against Ptolemy, which he prosecuted in Cyprus in 306 (Figs. 189, 190), showing especial skill in the siege of fortified places (whence his appellation Poliorcetes, 'besieger of cities'), and conquered the whole island. It was this success which led Antigonus and Demetrius to assume officially the royal title. Ptolemy answered at once by a like step, and was followed by Cassander, Lysimachus, and Seleucus.

The next great enterprise of Demetrius was less successful. Rhodes refused to aid in the war against Ptolemy; and in 305 he invested the city with a vast army and fleet. The heroic islanders held out against his attacks with unsurpassed bravery and determination. After exhausting all the resources of military science, during a siege of over a year, Demetrius, whose arms were needed elsewhere, concluded a peace with the Rhodians on honorable terms. He was called to Greece to meet a great invasion of Cassander, who was already besieging Athens. Demetrius raised the siege, and gradually pushed Cassander northward, until in 302 the hostile armies confronted each other in Thessaly. But the expected battle did not take



FIG. 191. — Demetrius Poliorcetes. (After Visconti.)

place. Antigonus, who was at the moment seriously threatened in Asia, recalled his son; and Demetrius, concluding for the present a treaty with Cassander on the basis of retention of present possessions, led, toward the end of B.C. 302, his army to Ephesus.

Seleucus, Ptolemy, Lysimachus, and Cassander had formed a new alliance against Antigonus. In 302 their armies invaded his territories on every side. The decisive battle was at Ipsus, in Phrygia, in the summer of 301. The two armies, the one under Antigonus, Demetrius, and King Pyrrhus of Epirus, the other led by Seleucus and Lysimachus, each numbered 80,000 men. Antigonus was defeated and killed, and with him perished the last hope of re-establishing Alexander's empire. Demetrius withdrew to Ephesus, where he waited for the victors to fall out over the spoils. This they did in a few months. Demetrius joined Seleucus against Ptolemy. The new alliance lasted, however, only until 298. Demetrius now made one more attempt (298)

to conquer Greece. But when he appeared before Athens he found it no easy task; for the patriotic democrats, such as Olympiodorus, Philippides, and Demochares, who had received money and provisions from Egypt and Thrace, and the present leader of the Cassandrian party, Lachares, held valiantly together against the assailant. But on the death of Cassander, in 297, the Macedonian crown fell to his eighteen-year-old sickly son Philip IV., who left it four months later to his brother Antipater; and in the absence of Demochares, Lachares, at the end of 297, made himself tyrant at Athens. Demetrius had, under these circumstances, better chances. A long siege and finally a fearful famine broke the courage of Lachares, and a commotion in the city itself at last caused him to flee. Athens now fell into the hands of the victor, who treated the city, indeed, with great mildness, but kept the forts garrisoned, and placed, moreover, a guard in the newly established fort on the Museum hill, opposite the Acropolis. Meanwhile Ptolemy won over the young and knightly Pyrrhus to his side, and put him (about 297) with money and troops in position to establish himself again in Epirus. Events now follow with the rapidity of the changes in the kaleidoscope. In Macedonia the sons of Cassander, Antipater and Alexander, quarrelled furiously. Alexander fled to Demetrius, who put him to death on the charge of conspiring against his life, won over the Macedonian army, drove out Antipater, and found himself, in 293, king of Macedonia without a rival. He now thought to repeat the career of Alexander the Great, and prepared immense armaments. This aroused the other kings against him. The Macedonians were disgusted by his debauchery; and when war broke out in 288, his army went over in a body to Pyrrhus, who seized the kingdom of Macedonia. Demetrius, after a vain attempt to capture Athens, escaped to Asia, where he was soon forced to surrender to Seleucus, who kept him in a kind of magnificent captivity until his death (283-282). Lysimachus, in 287, drove Pyrrhus back into Epirus, seizing Macedonia for himself. Antigonus, the son of Demetrius, retained control of many places in Greece.

Thus the conflicts seemed everywhere to have spent their strength. Even in the Hellenistic Orient matters had assumed a settled form. Seleucus had reorganized his extensive empire, dividing the great provinces into more than seventy smaller satrapies. Not less practically and solidly had Ptolemy (Fig. 192) organized his far more united kingdom, where Alexandria already extended its trade relations as far as Ethiopia and India. Here Ptolemy, in 285, two years before his

death, abdicated the Egyptian throne in favor of his second son, Ptolemy II. (Philadelphus). Nevertheless, the age of the Diadochi, as it had begun with scenes of horror in Babylon, was to close with conflicts which once more shook the world from the rivers of Mesopotamia to the Adriatic.

Sicily had for some years enjoyed comparative quiet under the able Agathocles (Fig. 193), who ruled Syracuse and its dependencies from



FIG. 192. — Coin portrait of Ptolemy I. (After Visconti.)

B.C. 317 to B.C. 289, first as tyrant, then as king. At one time defeated and besieged in his capital by the Carthaginians, he restored his fortunes by an unexpected and brilliant descent upon Africa, and concluded an honorable peace in B.C. 305. But Agathocles was murdered, in B.C. 289, at the instigation of his grandson Archagathus. The latter soon met a like fate; and for some years a series of petty tyrants struggled for the supremacy in Syracuse and the other cities of the island, while the

former Campanian mercenaries of Agathocles, calling themselves Mamertines, or 'sons of Mars,' seized the town and women of Mesana, and ravaged far and wide.

The aged Lysimachus, in 284, allowed himself to be prevailed on by the wiles of his second wife to have his son by a former marriage, Agathocles, murdered. The horrible occurrence called forth profound resentment, and not alone in the king's own realm. Seleucus finally yielded to the calls from Thrace, and war broke out toward the end of the year 283. Lysimachus was defeated and slain. Asia Minor was now incorporated into the monarchy of the Seleucidae; Thrace reserved for the children of Agathocles; while Seleucus, giving up to his



FIG. 193. — Agathocles, King of Syracuse. Head of Cora (Persephone.) With a wreath of ears of corn. ΚΟΡΑΕ. Rv.: Niké, with hammer and nail, fastening a coat-of-mail, shield, and greaves on the stem of a tree, and on this trophy fixing a helmet.

son Antiochus all Asia from the Hellespont to the Indus, laid claim to Macedonia for himself. But when he crossed the Hellespont, late in 281, Ptolemy Ceraunus, Philadelphus's elder brother, who had been, because of his dissolute and savage character, excluded by his father from the succession to the Egyptian throne, murdered the old king in

the Chersonese, and usurped authority in the European territories of Lysimachus. The murderer found himself threatened by the troops of Antiochus, while on the side of Greece the young king Antigonus united with the Aetolians, in order to seize Macedonia for himself. But Pyrrhus of Epirus, who under other circumstances might have been the most dangerous adversary of the usurper, was almost immediately called to Italy to defend the Tarentines against the encroaching power of Rome; and Ceraunus was permitted to enjoy his blood-stained throne, though only for a little space. In the first half of the year 279 a great horde of Celtic marauders, 200,000 strong, burst upon the Balkan peninsula. A band under Cerethrius threw itself upon Thrace; a second, under Brennus and Acichorius, upon Paeonia; a third, under Bolgius, on Illyria and Macedonia. Ptolemy Ceraunus, who madly attempted with his hasty levies to meet the invaders in the field, was completely defeated and lost his life (May, 279). All Macedonia, except the fortified towns, was exposed to horrible ravages. In 278 one detachment turned eastward, and ultimately settled in Asia Minor, where they became the Galatians of later history. The main body, under Brennus, advanced through Macedonia and Thessaly, in order to lay waste Greece. But here they met with brave resistance. One army was cut to pieces amid the mountains of Aetolia. Another, after flanking the pass of Thermopylae, by the same difficult path which the Persians had taken two hundred years before, was defeated with great loss at Delphi. Brennus himself fell, and the remains of the barbarian host withdrew into the unknown wildernesses of the far north. Antigonus, who had gained some prestige by a success on the Hellespont over the eastern section of the invaders, hastened to Macedonia, where, gladly received as king by the war-weary inhabitants, he established, in 277, the dynasty of the Antigonidae. Thus ended the stormy period of the Diadochi.

396

PART VI.

THE AGE OF THE EPIGONI.

(B.C. 277-217.)

CHAPTER XVIII.

THE STATES OF THE EPIGONI.

THE Diadochi, the 'Successors,' who partitioned the realm of Alexander, were followed in their several kingdoms by the princes known in history as the Epigoni, the 'Afterborn' (from their having had no part in Alexander's campaigns), whose period extends to the interference of the Romans in the affairs of the East.

The main part of the old Persian empire was now in the hands of the Seleucidae, who, from their capital, Antioch in Syria (founded about 300), reigned at first from the Hellespont to the Indus. Their dominions were loosely knit, and the northern and eastern provinces showed a constant and finally successful tendency to drop away. On the other hand, vast numbers of Greek settlers flocked into Asia Minor, Syria, and Mesopotamia, giving to these lands an appearance of Hellenic culture and civilization which was much more than a mere veneer. Antioch, with imposing architectural monuments and a vast commerce, became one of the great cities of the world. The most distressing feature in considering the history of this kingdom is the character of the sovereigns, who were, almost without exception, dissolute, treacherous, bloodthirsty, and madly ambitious; and in the end — though not until after the period with which we deal — utterly incapable.

Ptolemy organized his Egyptian kingdom much more solidly. The old religion, the hierarchic arrangement of the Egyptian people, the caste system, so far as it existed, the division of the provinces, and the old laws were carefully respected; but so much the more vigorously the royal power developed. Great care was shown for trade, commerce, and general prosperity. The finances were strictly and ably managed.

Under Ptolemy Philadelphus the yearly revenue was \$14,000,000, and the treasury surplus amounted to \$650,000,000. The capital was Alexandria, which became the chief commercial and literary centre of the world. A powerful standing army was maintained, composed largely of Greeks and Macedonians. The mixture of Egyptians and Greeks was zealously favored. Universal religious toleration was practised; the Jews settled at Alexandria in large numbers, and the kings on their accession were consecrated by the Egyptian priests as 'sons of the sun.' With the extraordinary prosperity of the valley of the Nile, with the help of a great war-fund, a mighty fleet, and an excellent army, the Ptolemies secured peace at home and respect abroad; and during the troubles of the period, gained possession of many islands and cities in and around the Aegean and the eastern Mediterranean.

The third great state of the Epigoni, Macedonia, had been in the past fifty-six years greatly depopulated,—an evil which could not be again wholly overcome until late in the period of the last Macedonian kings. The Antigonidae were favored by a necessity felt everywhere in Greece, namely, a strong power established again north of Olympus, as a protection against the northern barbarians. The foreign policy of the Antigonidae was, above all, to control the Hellenic countries, which were partly held by garrisons, partly secured by friendly tyrants. While a not inconsiderable part of the Greeks became reconciled to the Macedonian supremacy, gradually new forces came to the front in the Achaean and Aetolian leagues.

In the midst of this new expansion of Greek life, to which when occurring in non-Hellenic countries the name Hellenistic is applied, the connecting bond was Greek science and literature. The men of science, and especially the philosophers, represent the universality of Hellenic culture, which in this age had begun its triumphant march to Bactria and Iran, and later to Rome. Besides other elements, the exact sciences especially now attain higher development. Geography, mathematics, astronomy, natural sciences, and military tactics enjoyed especial favor. Closely connected with the transfer of a large part of the Greek people to the east, was the rise of a new peculiar centre of the universal culture which was arising on Greek foundations, namely, Alexandria. The house of the Ptolemies ever generously patronized the sciences. Alexandria controlled the new Hellenistic culture, and gave the tone to the intellectual life and scientific efforts of the succeeding centuries. Under the zealous co-operation of the first two

Ptolemies, two institutions of the highest importance were established here, the Library and the Museum. The great library was founded by the elder Ptolemy, on the advice of Demetrius of Phalerum. Situated in the quarter Brucheum, with a branch in the Serapeum, this gradually covered the whole literature of the Greek nation, with Greek translations of the literary treasures of other peoples,—Egyptians, Persians, Chaldeans, and Jews,—and from the beginning employed a great number of eminent men of letters. Of the librarians, the first six especially won high reputations,—Zenodotus of Ephesus; Callimachus of Cyrene, poet and philologist; Eratosthenes, a man of encyclopaedic knowledge; Apollonius Rhodius, the epic poet; and, most conspicuous of all, the grammarians and critics, Aristophanes of Byzantium, and his pupil, Aristarchus of Samothrace, whose activity belongs to the second century B.C. Directly connected with the Library was the celebrated Museum, a community of learned men, like the fellows of the English universities, to whom, by the generosity of the Lagidae, an honorable support was provided in the form of yearly pensions and the privilege of freedom from public duties and burdens. Its official head was the high priest of the Muses. Besides the Library and the Museum, the city had surgical institutions, zoölogical and botanical gardens, and observatories. Alexandria thus became the centre of an encyclopaedic culture, such as corresponded to the character of the new time, and, until the period of the Roman empire, set the fashion of the literature written in the Greek language, a literature which grew upon the soil of learning. The most brilliant side of the Alexandrian literary era must, therefore, be sought in the domain of the exact sciences and of philology. The natural sciences (especially medicine, astronomy, geography, and mathematics) flourished greatly. Philological study was greatly stimulated by the treasures of the library. Grammar received its finished form from Aristarchus; the lower and higher criticism, lexicography, metric, exegesis, investigations in the practical branches of antiquity, really grew first on Alexandrian soil. It was owing to the diligence of the scholars and of the strictly philological school at Alexandria, and afterward of those at the library at Pergamum, that later antiquity received the classic masterpieces in correct form, and with the necessary helps to their proper understanding. Aristophanes of Byzantium, Aristarchus, and Crates of Pergamum, are the most brilliant names in this line.

Poetry in this soil took on the character of a hothouse plant. The learned Callimachus won fame by his hymns, elegies, and epigrams.

The author of the epic "Argonautica," Apollonius Rhodius, who wrote in the time of the second and third Ptolemies, has the art of pleasant narration, graceful description, and fine delineation of psychological moods. Really noteworthy results were reached in the line of the epigram and of the idyll. The most charming of these creations are the celebrated bucolic poems of the Syracusan Theocritus (born about 295), who made frequent sojourns in Alexandria. Going back to the simple motives of the Sicilian popular poetry, he created pictures of the shepherd, peasant, and lower-class life of his native island, which are characterized by rare sweetness and fidelity to nature. The technical works of this period, on the contrary, paid no attention to artistic form. The philosophers, in creating their harsh terminology, had only the school in view, not the larger public. Instead of eloquence, rhet-



FIGS. 194, 195.—Zeno. Epicurus. (After Visconti.)

oric dominated, especially in the schools of Asia Minor, where the bombastic 'Asian' school long prevailed. The historians of the period have little real ability; but we must mention the Siceliote Timaeus, of Tauromenium (356-260), who, in his history of Sicily, first made extensive use of the reckoning by Olympiads.

Athens still maintained her old rank as the main seat of the different schools of philosophy. Here the schools of Plato (Academics) and Aristotle (Peripatetics) had regular organizations, and their real-estate at the Academy and at the Lyceum was handed down from one scholarch (head master) to the next. It was not long before the Academy and the Lyceum found competitors. Zeno of Citium (Fig. 194) in Cyprus (340-267) early settled at Athens, and at first attached himself to the ethics of the Cynics. Advancing further, in his effort to reach a satisfactory view of the world, and to establish a practical philosophy of life, he studied the theories of the various other Socratic

schools and those of older philosophic systems. Not long after 308 B.C. he founded the new school of the Stoics, who took their name from the fact that he and his followers taught in the celebrated 'Stoa Poecile' at the Agora.

Almost at the same time with Zeno's coming appeared another philosopher, whose theory stood in sharp contrast to the Stoic. Epicurus (Fig. 195), born 341 B.C., the son of an Attic cleruch on the island of Samos, after 306 made his permanent residence at Athens, and fitted up, near the gate Dipylon, an extensive 'garden,' with all the appurtenances for his family and his numerous philosophic friends, where as a fruitful writer and head of a new philosophic school, retired from public affairs, he led a pleasant and cheerful life. Dying at the age of seventy-two, he left a reputation for purity of morals, moderation in enjoyment, and real goodness of heart. His ethics were founded on the earlier system of Aristippus, which they deepened and ennobled. Happiness with him was perfect self-sufficiency, the highest calmness of soul, the highest inward peace, the highest inward freedom and independence. The more unworthy of his followers misunderstood his doctrine, and interpreted it to mean the philosophic encouragement of mere sensual pleasures.

The development of the Stoa, however, especially under Chrysippus of Soli (280-210), was quite different. The Stoics won their importance by their ethics. According to their view there could be nothing higher for man than to live in the universal, for the universal, in agreement with universal nature. Therein is man's highest and only good and happiness. Reasonable or virtuous action, in their view, was that which has conformity to nature as the single motive and measure, and in good conduct finds its only satisfaction. By such a life man fulfilled, in their view, his natural purpose; this was to be, therefore, the highest good and the way to happiness, which with them consisted only in the moral life as such. Virtue was, for the just and perfect Stoic, the only good. Only the morally good had value. It alone was for its own sake desirable. Stoic ethics effected, it is true, no universal shaping of moral life; and the moral ideal of the wise man placed in its stead led in fact to a subjective abstraction absolved from all the conditions of real life. Defective and crude in theory, Stoicism in practice led to noblest results. At bottom it was an effort of excellent and noble natures to prevent the disintegration of the elements of antique morality. Moral heroism, ethical idealism, austerity of manners, were in manifold ways the mark of excellent men of this school, who often

also exhibited, indeed, self-sufficiency, consciousness of their own wisdom and excellence, and pride in their own virtue.

Greek schools of art, as also artistic handiwork, displayed in this century great activity. For, owing to the rise of the new Hellenistic states, the commissions to artists were greatly increased. It is noteworthy that in the age of the Diadochi and the Epigoni a double tendency toward the realistic and the monstrous prevailed, which found expression in the preference for the passionate and pathetic, for representations of horrible sufferings and mighty displays of strength. The school of Rhodes especially, where the bronze colossus of Helios, 105 feet high, stood at the harbor, was interesting from its tendency towards the colossal.

The interminable wars of the Epigoni, save perhaps those of the Antigonidae in Greece, are without interest or importance, except as, by



FIG. 196. — Coin-portrait of Antiochus I. (After Friedländer and von Sallet.)



FIG. 197. — Coin-portrait of Ptolemy III. (After Visconti.)



FIG. 198. — Coin-portrait of Ptolemy IV. (After Visconti.)

weakening the Hellenistic world, they prepared the way for the easy triumph of Rome in the East. For a long time after the death of the first Seleucus, Egypt steadily increased in power and influence, while after the death of Antiochus I. (Fig. 196), in 261, Syria, weakened by incapable rulers, as steadily declined. During this period two new states arose in inner Asia, — the Hellenistic Bactria, and the native power of Parthia, founded by Arsaces in 250, which represented the reaction of the Oriental spirit against the dominant Greeks. The reign of Ptolemy III., Euergetes (Fig. 197), which extended from B.C. 247 to B.C. 221, marks the culmination of the glory of the house of Lagus. Then the scale turned. Egypt declined, and Syria recovered much of her former power, until the intervention of Rome, on the death of Ptolemy IV. of Egypt (Fig. 198) in 205, against the Macedonian and Syrian kings, who wished to divide the inheritance of his

heir, showed that henceforth a new and stronger power than that of the Epigoni was to guide the destiny of the Greeks.

Among the smaller states of this period, outside of Greece proper, we need mention only Bithynia; Pergamum, a small but singularly well-ordered realm in western Asia Minor; and the great commercial republic of Rhodes.

CHAPTER XIX.

THE ANTIGONIDAE.—THE AETOLIAN AND THE ACHAEAN LEAGUES.

ANTIGONUS I. of Macedonia, notwithstanding his ability, secured for his kingdom only with difficulty the position of a great power. The Lagidae of Egypt were persistently hostile; the barbarians on the north and east were troublesome; but his most formidable foe was Pyrrhus of Epirus (Fig. 200), who returned from his Quixotic wars in Italy and Sicily in 274, and to keep his hand in immediately attacked his Macedonian neighbor. The erratic king was killed in a street-fight in Argos, in 272. Antigonus now thought to have a breathing-space in which to restore the internal prosperity of his kingdom, wasted by ninety years of almost continual warfare.



FIG. 199. — Coin-portrait of Ptolemy II. (After Visconti.)

In 266 a desperate revolt in Greece against Macedonia was brought about through the intrigues of Ptolemy II. (Philadelphus) of Egypt (Fig. 199), who had won great influence at Athens by his gift to the city of a magnificent library building, the Ptolemaeum.

The Athenian general Chremonides, from whom this struggle is known as the Chremonidean war, caused an uprising of the people, who entered into alliance with the Spartans, Achaeans, Eleans, Arcadians, and with Ptolemy, "for the security of the general Hellenic freedom." Antigonus advanced at once with a strong force against Attica, and Athens was invested by land and sea. The Egyptian fleet was defeated at Cos in 265. The Peloponnesus was subdued; and, after a most prolonged and stubborn resistance, the Athenians were finally forced to yield. They surrendered, in 263–262, and accepted all the conditions of Antigonus. A series of Macedonian military posts was established in Attica, one, indeed, even on the Museum Hill in Athens. The independent political significance of Athens was gone forever. From this time the kingdom of the Antigonidae was securely established as a great power. In Greece, however, it soon found its

supremacy threatened by the last phase of free Hellenic political life, the federal leagues of Aetolia and Achaia.

The Aetolians we have already become acquainted with. They appear in the time of Alexander politically and socially in still comparatively primitive conditions. They were a warlike people of shepherds and peasants, tried warriors, light-armed horsemen, later also bold seamen, spread out in open towns, villages, and farms in the territory between the Achelous and the sources of the Sperchius. In their most flourishing period, their bold and warlike nobility manifested once more the old Greek spirit of chivalry and delight in adventures by land and sea. The storms of the age of the Diadochi compelled the Aetolians to organize more thoroughly their old federal union. The political centre of the alliance was the open city of



FIG. 200. — Coins of Pyrrhus. — 1. Head of Artemis with ear-rings and necklace, the quiver protruding beyond the neck, in the field at the left a burning torch. Rv.: ΒΑΣΙΛΕΩΣ ΠΥΡΡΟΥ. Hovering victory, holding in her right hand the oak garland of the Dodonean Zeus, in her left hand the trophy. In the field on the left, the thunderbolt. Gold. — 2. Head of the Dodonean Zeus with oak garland. Rv.: ΒΑΣΙΛΕΩΣ ΠΥΡΡΟΥ. Enthroned goddess (probably Hera), with a sceptre and a high headdress. Silver.

Thermon, on Mount Panaetolicum. Here met every year, at the end of September, the Aetolian federal assembly or 'the general assembly of the land,' the 'Panaetolicum,' where all free citizens of the allied towns could appear, to decide about war and peace, and to appoint new federal officials. In case of necessity extraordinary conventions were summoned. The conduct of current business, and the preparation of proposals and matters for discussion for the assembly, were in the hands of the standing federal council, the Apocleti, who were composed of representatives of the different allied towns and districts. The chief among the annually elected federal officials was the strategus, the president of the alliance, who presided in the federal council and in the general assembly, and in war was commander-in-chief. Next was the hipparch, who commanded the cavalry in war. Besides these, there was a *grammateus*, the chancellor or state clerk. With all their prim-

itive simplicity and essentially soldier-like ways, the Aetolians had made this advance over the old forms of federal alliance, that the different districts remained autonomous only in internal matters, while in foreign relations all their sovereign rights were delegated to the whole body and its representatives.

The bearing of the Aetolians in the Lamian and in the Celtic war, the capacity for civilization, the tireless activity, readiness to fight, and delight in war, of this youthful branch of the aging Greek nation awoke at first among Greek patriots strong hopes for Greece, which, however, were only partially fulfilled. Warlike, energetic, and favored by their situation, the Aetolians attracted to their alliance many states of continental Greece, and even some places in Asia Minor. Their fatal weakness was their inveterate and unconquerable tendency for freebooting expeditions, which wasted their strength, raised them up enemies everywhere, and in general made them wholly unreliable and unserviceable in any enterprise requiring general co-operation and persistent effort.

The really national spirit of Hellas is represented, after the fall of Athens, not by the Aetolians, but by the league of the Achaeans, on the northern coast of the Peloponnese, who became the last representatives of independent Greek policy before Roman authority became dominant in the East. The Peloponnesian Achaeans suffered severely in the time of the Diadochi; their old confederation was broken up, and at the time of the Celtic invasion the Achaean cities were in the hands of Macedonian garrisons or tyrants. But a strong patriotic feeling still survived; and four cities in western Achaia — Patrae, Dyme, Tritaea, and Pharae — expelled, in 280, their garrisons, and made among themselves an offensive and defensive alliance. King Antigonus, who was then sufficiently occupied at other points, had no opportunity to subdue them again; and the chief place of Achaia, Aegium, in whose territory the federal sanctuaries lay, was able, in 276, to expel its garrison. The five communities proposed to form a federal state, the members of which were to be independent in internal administration; and every state that might join the new alliance was to have equal rights with the others. The old idea of the 'hegemony' was thus given up entirely. It was soon possible to free also the remaining old cities of the canton, — Bura, Cerynea, Leontium, Pellene, and Aegira, — so that now there was a small 'Achaean League' of ten cities. The little league gained new importance from the accession of the great and brilliant city of Sicyon and its excellent statesman Ara-

tus, in 249. Aratus was elected president of the league, in March, 245; and, as the Macedonians began to show hostility, Egypt grew friendly in like measure, and sent money to use in spreading the confederacy. Nearly the whole Peloponnesus, except Sparta and Messene, was won over.

Antigonus I. died in 239. His successor, Demetrius, though fully occupied by a Dardanian war, succeeded in so exasperating the Aetolians that they united with the Achaeans against him. Macedonian power south of Olympus on the whole steadily declined. In the course of the Dardanian war Demetrius was killed (229); and the regent, Antigonus Doson, who administered the realm in the name of the boy-king, Philip, had no leisure to devote to the affairs of Greece. This same year was marked by the withdrawal of the Macedonian garrisons from Attica, — which, however, still held aloof from both the Achaeans and the Aetolians, — and the destruction by the Romans of an Illyrian corsair fleet, which, instigated by Demetrius, had been plundering the west coast of Greece. The Corinthians granted the Romans admission to the Isthmian games, while the Athenians conceded to them the right of participation in the Eleusinian mysteries, as well as equality before the laws. The Achaean league was joined, after the death of Demetrius, by several states which hitherto had held aloof, and about 228 attained its greatest strength.

In the constitution of the Achaean League the sovereign power was represented by the federal assembly, which regularly met twice a year, May and October, at Aegium. To it every citizen of every league city, without distinction of class or of property, had access as soon as he had reached his thirtieth year. The citizens present from each city voted among themselves, city by city, so that not a majority of heads, but of cities, decided. By the side of this assembly stood a permanent federal council (the ten demiurgi), which, composed probably of paid representatives of the different places, managed the current business, and prepared the more important questions for the decision of the general assembly. The federal officials, who were chosen annually, in May, were the strategus, or league-president, who commanded the army, presided in the federal council, and on occasion also in the general assembly; a hipparch, and a grammateus. When it is further considered that to a great degree the magistracies and laws of the various cities, which moved for the most part within the forms of a moderate democracy, as well as their coins, weights, measures, and trade-rights, were arranged uniformly, and that, according to all probability, there

was a federal court for the adjustment of internal differences, the league of the Achaeans seems more firmly and uniformly organized than any of the older Greek alliances. The real weakness of the league was its attempt to stretch over a large territory a constitution really municipal or at most suitable only for a small province. As for the majority it was impossible to go twice a year to Aegium, the poorer part of the people was practically excluded from participation in important decisions. This circumstance, and the predominant influence exercised by the prominent wealthier citizens, gradually created permanent dissatisfaction among the masses, who were in great part impoverished by the sad state of affairs that had prevailed for several generations in the Peloponnese, as well as in Athens and many other parts of Greece. It was, moreover, unfortunate that the league had during this century no greater leader to direct its resources. Even Aratus, though a true patriot, an able diplomat, and not devoid of military skill, lacked the strength of character and breadth of view demanded by the times, and besides committed the fatal mistake of distrusting the common people, in whose elevation alone was there any real possibility of national regeneration.

New dangers to the Achaeans now arose, at first not from Macedonia, but from Sparta and Aetolia. In Sparta the old constitution had stiffened into an ultra-oligarchy. In the midst of a numerous and prosperous community of Perioeci and Helots, the patrician Dorian community numbered only 700 men, and of these most were impoverished. All land tended more and more to accumulate in great estates. In the middle of the third century these were in the hands of not more than one hundred Dorian families, given over, in spite of outward forms, to a luxurious Asiatic sort of life.

Agis IV. attempted, on his accession to the throne (245), at the age of twenty, not only to restore the old discipline, morals, and soldierly energy of the people, but even to rejuvenate the state by a general remission of debts and a new distribution of lands. But in 241 he was overthrown by a victorious reaction of the oligarchy, arrested by the ephors, and executed. The idea of a complete renovation of Spartan affairs was now taken up by Cleomenes III., of the other royal line, who was won over completely to the revolutionary views by his wife, the widow of the murdered king. Obtaining power about the year 235, when nineteen years of age, he concealed his plans from the oligarchy for several years. A powerful man, who united prudence to lofty enthusiasm and unusual strength of will, he saw that his only chance of

success lay in securing first a strong military position. This he could win only by war with the Achaean League. Soon after 228 Cleomenes showed the league the lion's claws, by bringing over to himself the cities of Mantinea and Orchomenus, without objection on the part of the Aetolians. Further aggressions resulted in open war, in which at first he won considerable successes. He then marched with his victorious army to Sparta (B.C. 226). He had the ephors cut down in their office, expelled from the land eighty men out of the hundred great families of the oligarchy, restored the full power of a military kingship, abolished the ephorate, substituted for the ancient Gerusia the council of Patronomi, which was dependent on the crown, carried through the abolition of debts, and effected a really new and complete equal distribution of the old Spartan lands. At the same time he supplemented the ruling class from the Perioeci until the number of the 'Spartan' hoplites reached 4000, renewed the old discipline of Lycurgus, and re-organized the army, which he armed with sabres, after the Macedonian fashion. These troops he led again, in 225, against the Achaeans, among whom the masses greeted with acclaim the social revolution in Sparta, while the higher classes lost all confidence in the generalship of Aratus. After a great victory at Hecatombaeum, near Dyme (in the spring of 224), Cleomenes offered the allies peace on condition that the hegemony in the Peloponnese should be transferred to Sparta. There can be no doubt that on the whole he represented the cause of freedom and unity; but the Hellenic mind again showed itself incapable of comprehending that these two ideals might be combined. A part of the Achaean cities at once went over to Sparta. The others, under the leadership of Aratus, called on Macedonia for help. Antigonus Dason led the forces of the allies against Cleomenes, and defeated him at the fatal battle of Sellasia, in Laconia (July, B.C. 222). The Spartan king fled to Egypt, and all his reforms came to nothing.

Greece, with the exception of the Aetolian League and of Athens, was now again permanently attached to the court of Pella. The new alliance united the different states as sovereign and with equal rights with Macedonia, which did not formally claim the hegemony. Nevertheless, Macedonian influence was dominant. Antigonus Dason died in 220, and the young king, Philip V. (Fig. 201), henceforth governed without a regent. The Aetolians, who, in their jealousy, had neglected to strike for Hellenic independence in the Cleomenean war, now, full of indignation, opposed the re-established power of the Antigonidae. Their plundering bands carried devastation as far as Messenia. In the

autumn of 220 the Achaeans declared war, appointing Philip generalissimo. The war was prosecuted with great savagery on both sides. Aetolia was fearfully laid waste by Philip, in 218. Gradually the strength of the Aetolians declined. And when in the early summer of 217 the news came from Italy that in the gigantic struggle that had recently broken out between Rome and Hannibal the mighty Carthaginian had almost completely destroyed the Romans at Lake Trasimenus,



FIG. 261. — Coin portrait of Philip V., of Macedonia. (After Friedländer and v. Sallet.)

the Greeks began to feel that compared with such decisive battles their own feuds appeared 'like contests at the games,' and that the self-destruction of the Graeco-Macedonian powers must not be carried further. They foresaw that the victor in this second Punic War would hardly halt at the Adriatic. It was an Aetolian, Agelaus of Naupactus, who, at the congress held in that city in the summer of 217, gave expression to the general sentiment of the Greeks. Philip was to be now protector of all Hellenes, and, as his proud spirit hoped, to interfere at

the proper moment in the Italian war. The peace of Naupactus, concluded on the basis of retention of present possessions, was the last which the Greeks made independently among themselves. Here we close the history of Hellas, and pass to the Romans, to the Italian nation, which just at this time was contending with Carthage for the empire of the world.

APPENDIX.

CNOSSUS AND PHAESTUS.

THE discoveries made at Cnossus, which have proved so important for our knowledge of Mycenaean times, were not the result of chance. The site has been well known to scholars who have long been desirous of excavating it, but the political conditions of the country have been such that this was not possible until Crete became independent of Turkish sovereignty. Since Evans acquired possession of the land systematic excavations have been carried on with the greatest possible success. A huge palace has been uncovered which dwarfs by comparison the palaces of Tiryns and Mycenae, and far surpasses in size the somewhat similar palace recently found by Italian archaeologists at the Cretan town of Phaestus; and in the palace there is hardly a room which has not added much to our knowledge of the civilization of this early period. Fortunately Cnossus was not inhabited after late Mycenaean times, and the ruins, although only four miles from the modern town of Candia, had been very little disturbed.

The walls of the palace consisted of foundation walls of large gypsum blocks rising a yard or more above the ground, and above them a rubble wall covered with a coating of painted stucco. The common use of stucco gave the artists of Cnossus an opportunity, which they did not neglect, of covering the inner walls of the palace with paintings of different kinds, sometimes with landscapes, again with scenes of every-day life, or in some cases with rosettes and other similar designs. The west wall of the palace, which is well preserved to a height of about three feet, has on its outer side a projecting plinth perhaps intended to serve for seats, for it faces a roughly paved area which extends for some distance west of the palace (Fig. 202, *A*). It has been suggested that this was the meeting-place of the citizens, the ancient agora, where king and people might come together. A well paved causeway, as yet unexplained, runs from the southwest portico of the palace out into this paved area at an angle with the palace wall. On the west side of the palace at Phaestus there is a similar paved space and causeway.

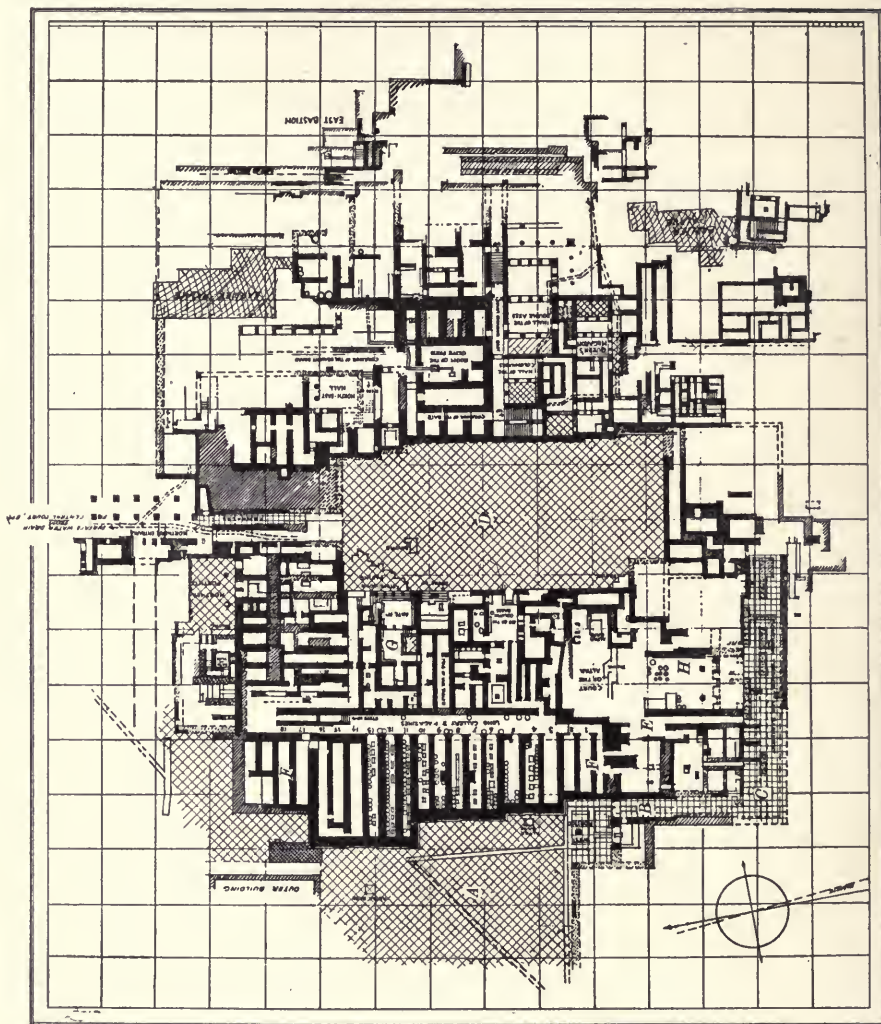

FIG. 202. — Plan of the palace at Cnossus. *A*, paved area. *B*, corridor of the procession. *C*, south corridor. *D*, central court. *E*, corridor of cup-bearer. *F*, *F*, magazines. *G*, throne room. *H*, south propylaeum.

In the southwest part of the palace there is a corridor (B) about eleven feet wide paved with limestone slabs and a border of blue slate originally covered with red stucco. The walls on both sides of this corridor were covered with life-size figures, apparently marching in a procession. Turning the corner into the south corridor (C) the procession continued as far as the great central court (D). The upper part of the figures is gone, but from fragments on the floor two have been reconstructed. These represent youths wearing richly embroidered loin-cloths and belts of blue and yellow adorned with spirals. One carries a vase. In a narrow corridor (E) leading from that of the procession another painted figure was found similar to the two just mentioned. It is a youth who wears a silver necklace and ear-rings, but in other respects is dressed like the two others. The features are almost classical—dark eyes, black curly hair, and a short head. The fact that the eye is painted in profile shows that the Mycenaean painters had solved a problem which Greek art did not solve until it reached its prime.

On either side of the great central court is an intricate series of corridors and rooms of different sizes and shapes. Close to the west wall of the palace are eighteen long chambers, side by side, which served as store-rooms (F, F). These still contained the huge jars in which oil, wine, and grain had been kept in Mycenaean times. In the floor of several of these magazines were rectangular receptacles, which originally held oil or wine for every-day use. Beneath them, and so arranged that it was necessary to remove a considerable portion of the pavement before they could be reached, was a second series of similar receptacles. As bits of gold-leaf were found in some of these it is not unlikely that the palace treasures had once been hidden here, but that they had been removed by their owners before the destruction of the building.

The most remarkable of all the rooms is the throne-room (G), reached by an antechamber from the northwest end of the great central court. On the south side of this room is a sort of cistern with steps leading down to a tank. The object of this is not yet clear. In front of this cistern and on two other sides of the room are stone benches projecting from the wall. In the middle of the north wall stands a throne of gypsum upon a square plinth. It has a high back of leaf-shaped outline bedded in the wall. The throne itself is about three and one-half feet high and the seat twenty-two and one-half inches above the floor. An elaborate design in red paint adorned the front of both back and seat. The paved floor and the benches were originally covered with red and white stucco. On the north and east walls landscapes were painted. There is a stream of water

in which an eel is visible. Rushes and flowers are growing on the banks, and hills are seen in the distance. Such scenes are suggestive of Egyptian art. There can be no doubt as to the character of this room. Here the king must have sat with his councillors to receive embassies and carry on other business of the state.

Quite as interesting as the throne-room were the clear evidences in several places of upper stories. On the south side of the palace the south propylaeum (H), which led from the corridor of the procession, must have served as the approach to a broad stairway leading to a series of large rooms on the second floor. But east of the central court part of a second floor was actually found still in position (PLATE XXII.), with stairs leading to a third story (PLATE XXIII.), and indications of a fourth above it. Quite as remarkable was the drainage system in this part of the palace. Ducts or shafts of stone provided with flush pipes ran from the upper floors down into conduits beneath the pavement. Light was introduced into the inner rooms of the palace by means of light-wells.

Everywhere in this great building were found proofs of the artistic skill of these early Cnossians. Frescos with human figures, both life-size and smaller, abounded. Among the smaller frescos is the head of a girl shown in PLATE XXIV. She has a large eye, very red lips, and black curly hair. She wears a dress looped up at the shoulder into a bunch of blue with red and black stripes and the fringed ends hanging down. Narrow red and blue bands run down the dress, which shows the white flesh beneath.

Still more remarkable are the miniature frescos found north of the central court. They represent scenes of every kind in which men and women are depicted, sometimes in great crowds, or again conversing in courts and gardens, or on balconies. In one case a number of people are collected before a brilliantly colored shrine; in another, ladies are looking out of a window which has a very modern curtain. These ladies wear high puffed sleeves joined across the neck by a narrow band. Their waists are slender, and they wear flounced skirts. The men are clean shaven, wear the loin-cloth and buskins, and have rings about their necks. This seems to have been their usual costume. All these figures are well drawn, and have a distinctly modern appearance. The method followed by the artist was to draw an outline first and then fill it in. The flesh of the men was colored brown and that of the women white, a practice followed by Greek painters in classical times.

In the eastern part of the palace there were found fragments of frescos representing a bull fight. There have been put together parts of two

PLATE XXII.



Pavement of Second Floor still in Position, the Palace, Knossos.

History of All Nations, Vol. III., page 414

PLATE XXIII.



Corridor of Second Floor, with Staircase leading to a Third Story, the Palace, Cnossus.

History of All Nations, Vol. III., page 414.

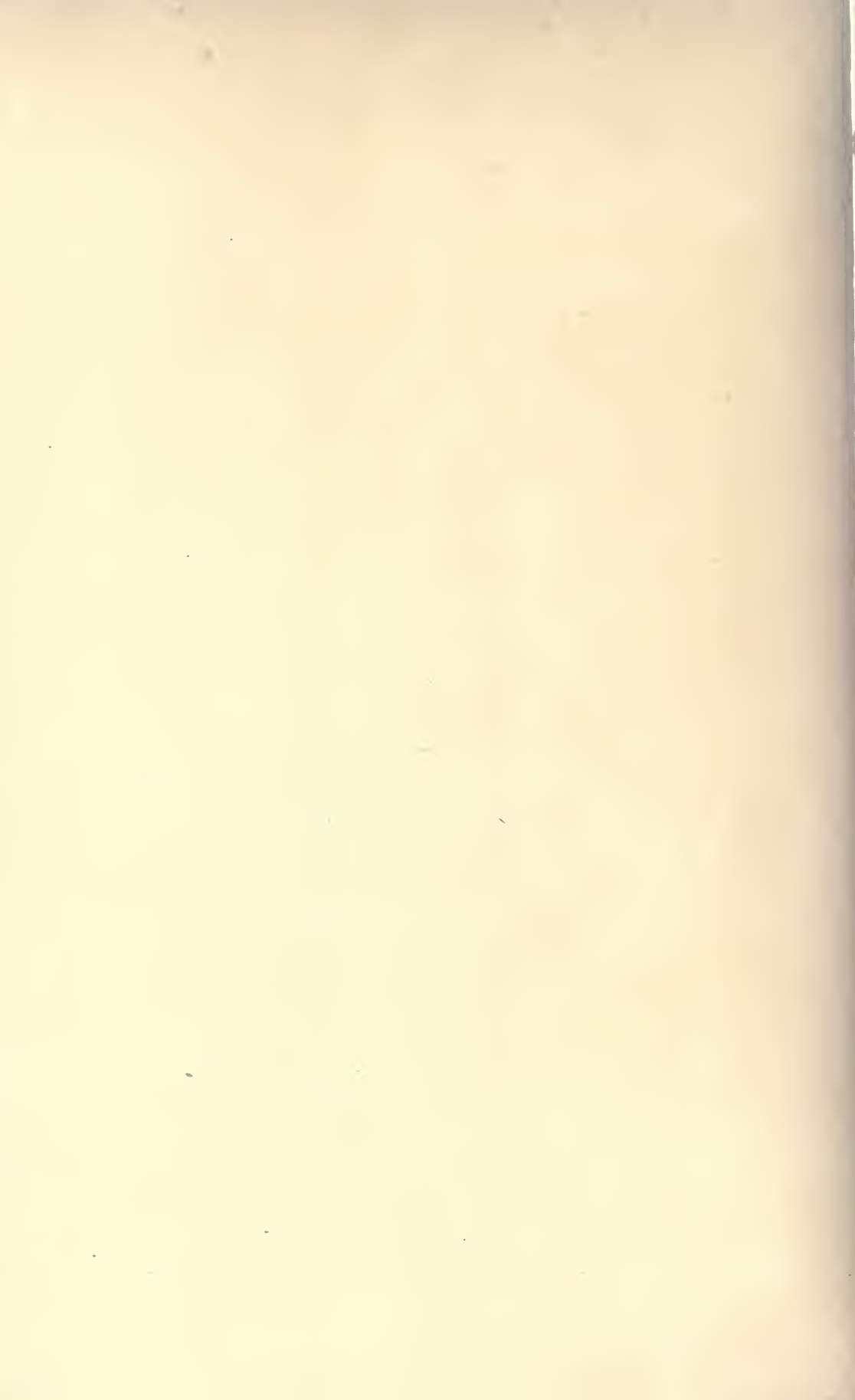

PLATE XXIV.



Wall Painting of a Girl, the Palace, Cnossus.



galloping bulls, one of which is tossing a girl, while another girl stands by as if to catch her. These girls wear the male costume, and are evidently female torcadors. A male athlete is turning a somersault over the back of the second bull. The bull was evidently the most savage of the animals known to the ancient Cnossians, and perhaps for that reason was a favorite subject with the artists of that period. Fragments of bulls, both painted and in plaster, were found in various parts of the palace, and others have been found on other Mycenaean sites. However, the most astonishing thing about all the frescos is the high degree of skill attained by the artists. This is also shown in the modeling of plaster figures, in both high and low relief, of which several examples were found in different parts of the palace. It took a long period of time for Greek artists of a later day to acquire an equal degree of skill. The development of art in Mycenaean times suggests the possibility that Greek art may in reality be a renaissance.

Quite as interesting as the frescos was a large mosaic, consisting of small porcelain plaques, many of which represented houses (Fig. 203). In fact, a whole street in ancient Cnossus might be restored from them. Some of these houses are of two, others of three stories, with windows of four or six panes. Some had one door and others had two. Such houses, which have a very modern appearance, point to a long period of civic life. Evans thinks the plaques once adorned a chest.

Still another find was the royal gaming-board, about three feet long and a foot and a half wide. It was very fragmentary, but can be restored with certainty. Rock crystal, ivory, and gold were the materials employed in its construction. Some of the ivory men with which the game was played were also found.

But of all the objects discovered in the palace the most interesting as well as the most important are the inscribed tablets. Previous to the excavation of Cnossus Evans had proved from carved gems and fragments of pottery that writing existed in Mycenaean times; but not even the most optimistic of archaeologists could have hoped for such evidences of it as were actually found. In all parts of the palace there came to light tablets of sun-baked clay inscribed with upright characters differing from any hitherto known. Most of the tablets were more or less broken because of the unsubstantial character of the material of which they were made, and in some cases it was necessary to add a backing of plaster before they could be removed from the ground. Moisture at once destroyed them. In some cases the preservation of the tablets was helped by the fire which destroyed the palace, although in other cases they were

so badly charred as to be illegible. The tablets were usually stored in sealed boxes, and numerous seal impressions in clay were found with them. Frequently these clay impressions were countersigned in Mycenaean script on the back. In a few cases even the strings to which the seals were attached were preserved.

These linear tablets (PLATE XXV.), as Evans has called them, are from one and three-quarters to seven and three-quarters inches in length, and from one-half to three inches wide. The inscriptions usually run in one or two lines along their entire length, but on the larger tablets there are often several such rows of characters separated from one another by horizontal

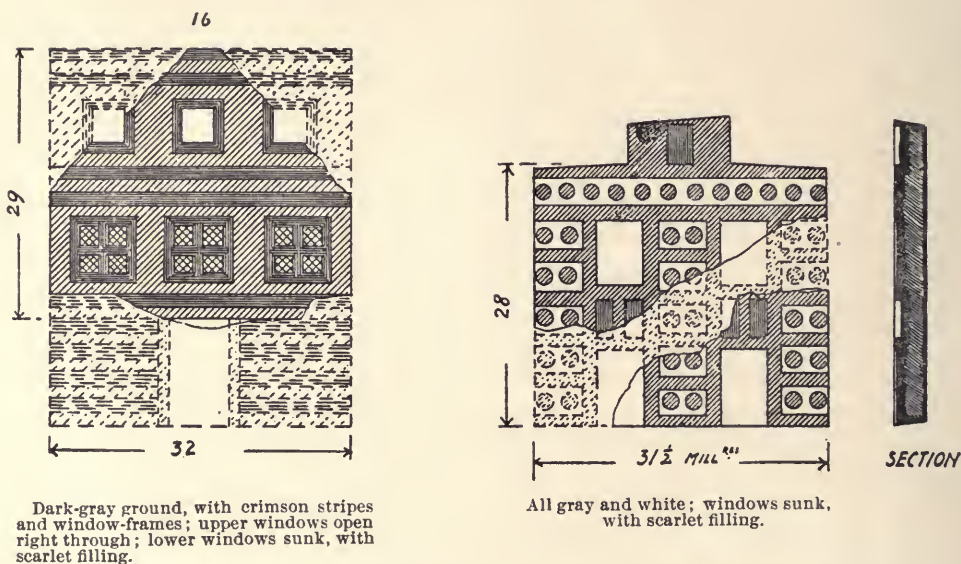
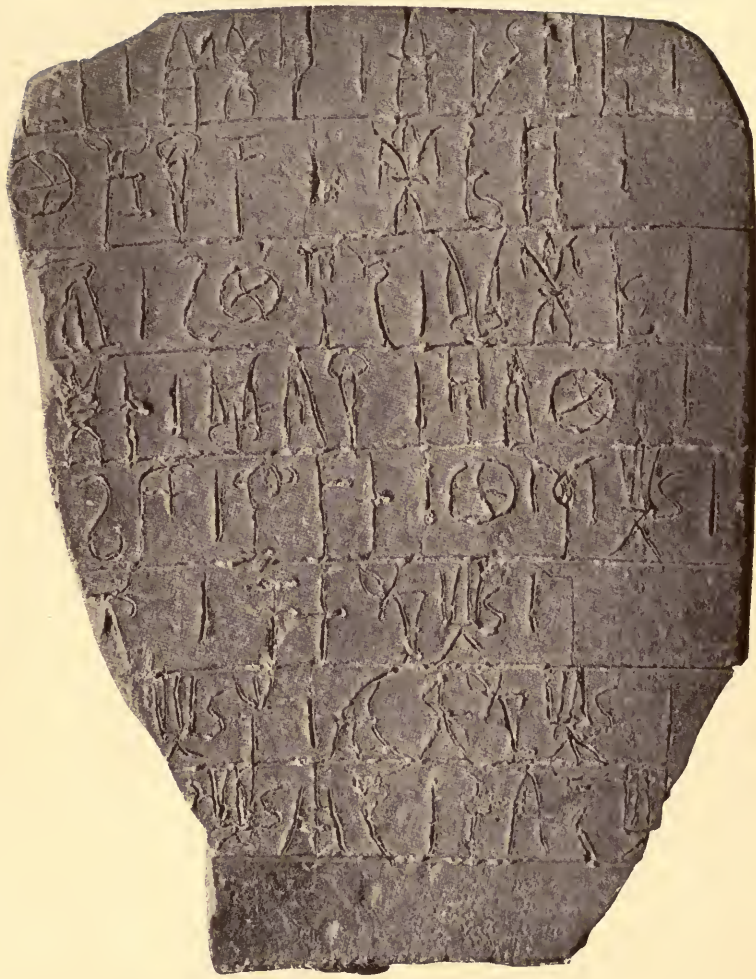

FIG. 203. — Mycenaean houses represented on porcelain plaques, the palace, Cnossus.

lines. One tablet has no less than thirteen. Occasionally the pictorial original of some linear sign may be detected, but in general the characters are far in advance of the cuneiform writing of the Babylonians and of the hieroglyphs of Egypt. About seventy characters seem to be in common use, and in addition to these there are a few signs used only with numerals, and apparently indicating weights and measures. There are a few signs which seem to be ideographs. About ten of the linear signs are identical with Cypriote signs; and as many more resemble Greek letters. Of the twenty-five signs found on pottery at Phylakopi in Melos, parallels to about six occur on the tablets of Cnossus. The numerals are somewhat like the Egyptian and can be read. A decimal system was in use. The

PLATE XXV.



Large Tablet with Linear Script, the Palace, Cnossus.

History of All Nations, Vol. III, page 416.

units are upright lines; the tens horizontal lines, although sometimes curved; the hundreds are circles, sometimes broken, with overlapping ends; the thousands are circles with four spurs. The frequency with which these figures occur proves that many of the tablets have to do with the palace stores. Sometimes a drawing was added, perhaps to indicate the contents of a tablet. For example, there are chariots and horses' heads (Fig. 204); human beings, perhaps slaves; houses; swine; ears of grain; trees; and various clay vessels. These will no doubt prove of assistance in the decipherment of the inscriptions. The same linear signs were also used for writing in ink, as characters in ink on clay cups prove.

In one part of the palace there was found a deposit of tablets entirely different from those just described. They were of peculiar shape, quadrangular or three-sided bars perforated at one end; also perforated 'labels,' as Evans calls them, in the form of bivalve shells; and three-sided sealings of clay. Altogether over one hundred different signs of a pictographic character occur upon them. These signs have no analogy to the

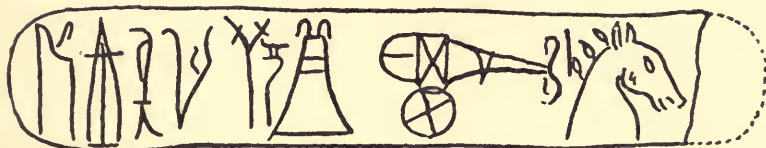

FIG. 204. — Tablet with linear script from the palace, Cnossus, perhaps referring to chariot and horses.

linear signs, but are the same as those found on many signets in eastern Crete. Some of the signets which antedate Mycenaean times show the signs in a much more primitive form. Evans is convinced that this pictographic script represents an indigenous system of writing distinct from Mycenaean. He argues that these tablets are probably in the language of the Eteoeretans, and represent tribute lists from the cities in eastern Crete; or that the people of eastern Crete were masters of the palace at the time when these tablets were written. The script is not divided into lines, but the characters are jumbled together, and in some cases present a boustrophedon arrangement as in early Greek inscriptions. The writing is often divided by cross-lines, and the beginning or end of a sentence marked by a cross.

The pottery of Cnossus too is most interesting. Aside from the typical Mycenaean ware, other varieties were found which were characteristic of Crete and even of the palace. The so-called Camares ware, consisting of a white decoration upon a black background, was found in abundance, as

was a local ware of which the development can be clearly traced. Many of the Cnossian vessels are light in weight, with beautiful decoration, and equal to the best work of the potters of Mycenae.

The date of this great palace cannot be determined with accuracy. Evans thinks that the building was completed about 2000, and destroyed about 1300 B.C. Underneath the palace at various points were found remains of the neolithic period, showing that the site was inhabited from the stone age until late Mycenaean times, but apparently not afterward.

Evans thinks that the palace at Cnossus is in reality the famous Labyrinth. The great number of rooms and galleries may well have given rise to the stories of a great maze, and, besides, he argues that labyrinth is etymologically connected with *labrys*, a Carian word, meaning axe. The double axe, the sign of the Cretan Zeus, was found carved in many parts of the palace. On the east side of the great central court this sign was repeated so frequently upon the walls of one of the rooms that the name of 'Hall of the Double Axes' was given to it. An actual shrine, found with the votive objects still in position, had near the sacral horns diminutive double axes of bronze, besides several terra-cotta figures of divinities and votaries (PLATE XXVI.). Whether or not Evans is correct in his interpretation of the Labyrinth cannot now be determined. It is clear, however, that the double axe had an important place in the religious ceremonies of this ancient people.

As yet but one of the royal tombs of Cnossus has been found. Upon a headland north of the palace a great stone mausoleum has come to light, consisting of a square chamber capped by a lofty gable constructed after the fashion of the galleries of Tiryns. This chamber, according to the reports, is approached by an arched entrance-way. There is no doubt that the passage was arched, although the upper courses are much ruined. This example of the arch together with the usual pointed Mycenaean gable is unique. No other true arch has been found in Mycenaean remains. The tomb had been plundered in antiquity, but a basalt bowl, part of a necklace of lapis lazuli, and other objects found within it, show what must once have been the character of its contents. It is possible that this may be the traditional tomb of Idomeneus mentioned by Diodorus Siculus.

Second in importance only to the discoveries at Cnossus are those made at Phaestus, a town on the south side of the island, southwest of Cnossus. Excavations were begun here in 1900 by the Italian archaeologist Halbherr, and a large palace gradually brought to light (Fig. 205). Phaestus was, however, unlike Cnossus, inhabited in classical times, so that remains of the later period were also found there. In fact a few graves of Byzan-

PLATE XXXVI.



Figures of Divinities and Votary found in Position in a Mycenaean Shrine in the Palace, Cnossus.

History of All Nations, Vol. III., page 418.



FIG. 205. — Plan of the palace at Phaestus. *A*, paved area. *B*, seats facing agora. *C*, altar. *D*, west corridor. *E*, staircase to upper story. *F*, staircase to upper hall. *G*, upper hall. *H*, megaron of men. *I*, interior corridor. *J*, bath-rooms. *K*, room with triglyph supports. *L*, central court. *M*, interior corridor. *N*, *V*, magazines.

tine times were discovered. The town was located upon three hills on all of which Mycenaean remains have been found, but the royal palace was situated upon the easternmost of the three, which is the largest, although the lowest. As at Cnossus, remains of an earlier building were found beneath that of Mycenaean date, and stone axes and pieces of obsidian show that the site was inhabited in neolithic times.

Immediately west of the palace, as at Cnossus, there is a paved area (A) with a causeway crossing it diagonally, in this case leading to a broad flight of steps or seats (B) upon the north side (PLATE XXVII.). There are eight of these steps with a broad platform above them, and back of this a wall of squared blocks. As these steps are higher than they are broad it is likely that they were used for seats. A large altar (C) in the corner where the steps join the palace-wall shows that religious ceremonies were sometimes held here.

On the western side of the palace and just inside its western wall is a broad corridor (D) more than one hundred feet long, and varying in width from twenty-three to twenty-eight feet. This is on the same level as the platform above the steps just mentioned—that is, the level of the Mycenaean palace. From this corridor lead two flights of steps (PLATE XXVIII.), one of twenty-three steps fourteen feet broad running north, and shut in on both sides by walls (E); the other of twelve steps about forty-five feet broad (F). Both stairways once led to the upper story, but the latter of the two must have served as the main approach to the great hall on the second floor (G).

At the south end of the western corridor there is another corridor (H) running east and west and cutting the building in two. The sides of this corridor are of heavy blocks of stone once covered with red stucco, and the floor is paved with large blocks of gypsum which were also colored red. The rooms north of this passage were larger and evidently more important than those south of it, some of which seem to have been used for culinary purposes. Two of the rooms (I, I) were apparently bathrooms, such as were also found at Cnossus.

The only other room of especial importance in this part of the building is Room J, which is remarkable because the benches on its north and west sides are supported by slabs of stone curiously carved with alternate series of vertical and horizontal lines. The slabs thus carved bear a distant resemblance to a Doric frieze with its triglyphs and metopes. The benches are of the same height as those of the throne-room at Cnossus.

At its eastern end the corridor opens into a great central court (K) about one hundred and fifty-five feet long by seventy-four feet broad, paved with large rectangular blocks of stone. The chief entrance to the palace

PLATE XXVII.



Seats Overlooking Supposed Agora, Phaestus.

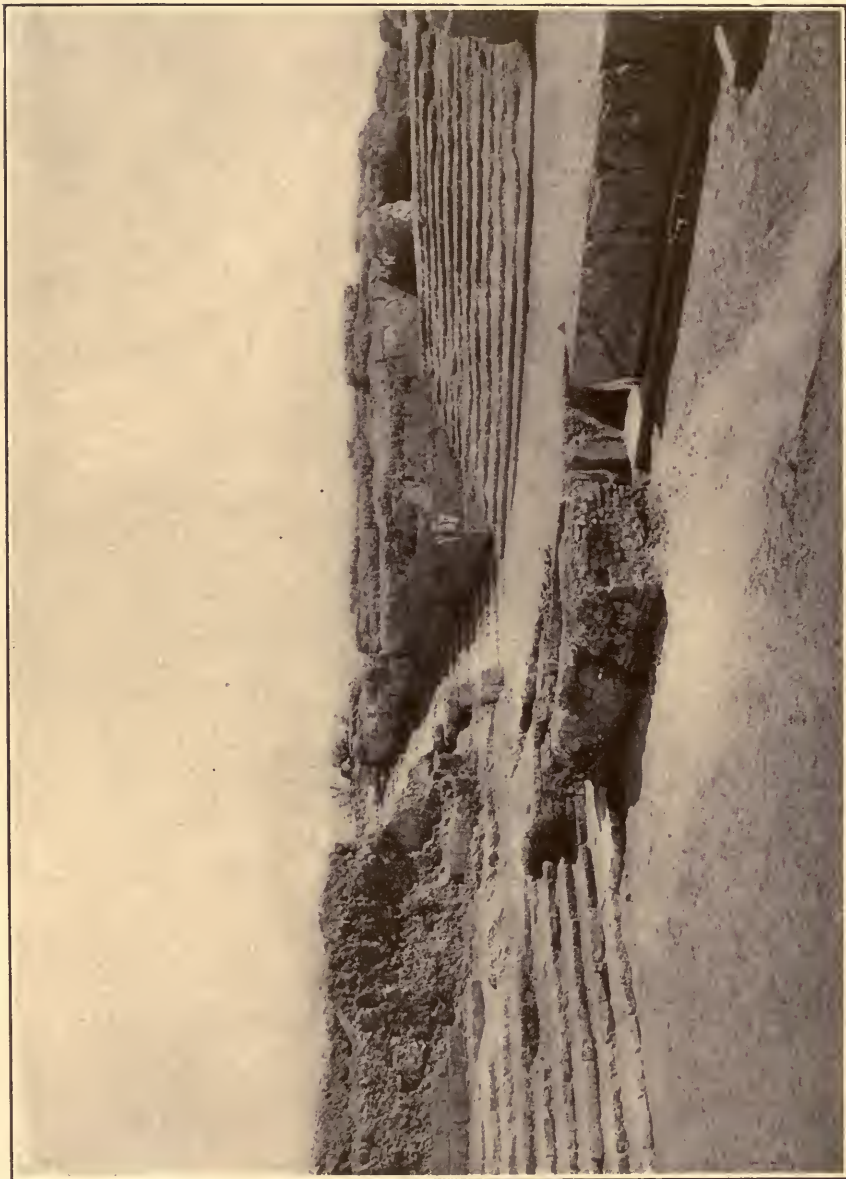

Stairs Leading to Upper Story: at the left, seats facing agora; in the centre, altar;
at the right, west corridor, the Palace, Phaestus.

History of All Nations, Vol. III., page 420.

420³



Interior Corridor showing Entrances to Magazines, the Palace, Phaestus.

4204

PLATE XXX.



Upper part of Steatite Vase from Hagia Triada, near Phaestus.

must have been through this court. On its west side lay the hall or megaron of the men (L), back of which was another corridor (M, and (PLATE XXIX.) running east and west. On either side of it are rooms (N, N) which, from their similarity to the magazines at Cnossus, were undoubtedly used for the same purpose. The rooms north of the central court seem to have been the apartments of the women; those to the east have not as yet revealed anything remarkable.

Few objects of great interest were found in the palace at Phaestus. Numerous pieces of painted stucco came to light, but no such wall paintings as were found at Cnossus. Fragments of vases were turned up on all sides, but only one inscribed tablet, although there were numerous signs of writing. A few votive double axes and a few rude idols came to light during the excavations.

At Hagia Triada near Phaestus the Italians have uncovered what Pernier calls a Mycenaean villa. Here fragments of five tablets inscribed with linear characters, and the upper part of a carved stone vase (PLATE XXX.), were the most remarkable things found. The vase is of black steatite, a material much used for vases by the Mycenaean of Crete, but its decoration is unique. A band of Cretan warriors, armed with peculiar forked weapons, follow a leader who is equipped with armor. They are apparently singing as they march along, and may be supposed to be celebrating a victory. Nothing similar to this scene has been found elsewhere.

Excavations have been carried on at several other sites in Crete with more or less success, but in no case with results which can compare in importance with those attained at Cnossus and Phaestus. It is clear, however, that from about 2000 to 1200 B.C., and perhaps later, Crete was inhabited by a highly civilized people. Their numerous cities and towns, with the signs of wealth they contain, are proofs of their great prosperity. Who the enemy were who finally conquered the land and destroyed the palaces we do not know. More than this, we do not even know who these Mycenaean people were or what their language was. When the inscribed tablets are deciphered these problems will be solved. We know that this people had commercial dealings with the Egyptians, who seem to have called them Keftiu, a name afterward applied to the Phoenicians, and that they flourished not merely in Crete but in Greece proper, and on the islands of the Aegean, during the second millennium before our era. It seems very probable that within the next few years our knowledge of the early period of Greek history will be very materially increased, and that the influence of the traditions of Mycenaean civilization upon the development of the Greeks found to be much greater than has hitherto been supposed.

422

ANALYTICAL CONTENTS.

(FOR GENERAL INDEX, SEE VOLUME XXIV.)

BOOK I.

FROM THE PELASGIC PERIOD TO THE PERSIAN WARS.

PART I.

FROM THE EARLIEST PERIOD OF GREEK HISTORY TO
THE FIRST OLYMPIAD (776 B.C.).

CHAPTER I.

LAND OF THE GREEKS.

	PAGE
Geographical Extent of Greece ; Theatre of Greek History	19
Relation of Greece to the Orient and to the West	20
Northern and Central Greece, the Mountains, Rivers, and Bays	20
The Peloponnese, its Mountains and Cantons	22
The Islands, Cyclades, Sporades	23
Hellenic Asia Minor	24
Physical Features of Greece ; their Effect upon Political Character	24
The Dualism of the Greek People	25
Richness and Variety of Political Organisms	25

CHAPTER II.

PELASGIANS, ACHAEANS, AND HELLENES.

Ethnic Relations of the Greek People	27
The "Pelasgians." Life in the Pelasgic Age ; Religion and Mythology	28
Early Phoenician Influence on Greece	30
The Heroic Age, Heracles, Baal Melkarth	31
Development of Military Skill, <i>Larissae</i> , the Cities	32
Heroic Legends, the Argonautic Expedition	36
The Seven Against Thebes and the Siege of Troy	37
Dr. Schliemann's Excavations at Troy	37
Chief Features of Greek History in the Heroic Age	38
The "Achaeans ;" Tribal and Constitutional Developments	38
The Ionian Race and its Early Homes	38
Pre-Dorian Peloponnese, Argos and Mycenae	39

	PAGE
Monuments of Mycenae and other Objects of the Mycenaean Age	40
Development of Civilization, Decline of Savagery	40
Very Recent Archaeological Discoveries	47
Early Non-Aryan Inhabitants of Greece	47
The "Aegean" Race and its Civilization	48
Crete before 2500 B.C. A Connecting Link between Europe and Africa	48
Mixture of Populations in Crete	48
Two Systems of Writing in Use in Crete	48
The "Mycenaean" Civilization about 1500 B.C.	49
The Cities on the Site of Troy	49
Sixth City, founded about 2000 B.C.	50
Sixth City, Homer's Troy	50
Second and Sixth Cities most interesting	51
Schliemann's Great Treasure found in Second City Wall	51
Walls of Sixth City well Built	52
The Greeks, of Aryan Speech, enter Greece about 3000-2500 B.C.	53
The Dorian Invasion the last Wave	54
Relation of the Invaders to the Original Inhabitants	54
The Greek Dialects	54
Decipherment of the Cretan Tablets Awaited	55

CHAPTER III.

THE THESSALO-DORIAN MIGRATION AND ITS RESULTS.

The Thessalo-Dorian Migration	56
The Heraclidae and the Dorians	57
Invasion of the Peloponnese and Displacement of the Ionians	58
Other Movements in Greece; Legendary Attic History	60
Colonies upon the Shores of Asia Minor	61
Development of Dorian Civilization in the Peloponnese	64
Characteristics of the Greeks in this Period; Language and Social Life	65
Development of the "Hellenes"	67
Rise of Delphi; Early Greek Gods	68
Greek Life as Portrayed in Epic Poetry	73
Supplementary Pictures from Hesiod, Country Life	76
The Spartan State; the Lycurgean Constitution	77

PART II.

FROM THE FIRST OLYMPIAD TO THE REVOLT OF
ARISTAGORAS OF MILETUS (776-500 B.C.).

CHAPTER IV.

THE COLONIAL EXPANSION OF THE GREEKS.

The Colonial Expansion of the Greeks	83
Nature of the Greek Colonies and their Geographical Extent	84

	PAGE
Relation of the Colonists to the Displaced Populations	85
Olympia and the Olympic Games	88
Other Pan-hellenic Festivals; the Isthmian and Nemean Games	93
The Shrine of Apollo at Delphi; the Oracle	94
Influence of Delphi upon the Development of Hellenic Civilization	95
The Delphic Amphictyony	97

CHAPTER V.

GREECE IN THE TIME OF PATRICIAN RULE.

Kings Give Place to Aristocracies	98
Elements of the New Aristocratic Constitutions	99
Relation of the Rulers to the Commons	99
Life in Asia Minor; the Greeks and the Native Inhabitants	101
The Cities of Sicily and Southern Italy	102
The Early History of Attica; Development of the Athenian Constitution	103
Corinth, Megara, Sparta, Phidon of Argos	106
The Messenian Wars	108
Sparta Attains the Supremacy in Greece	110

CHAPTER VI.

TYRANNY, TIMOCRACY, DEMOCRACY.

Decline of the Aristocracy, Rise of the Demos	111
Characteristics of the Revolt against the Oligarchic Rulers	112
Timocracy the Aristocracy of Property	113
Rise of Tyrants and Characteristics of their Rule	114
Conditions in Miletus, Mytilene, Megara, Corinth, and Sicyon	117

CHAPTER VII.

SPARTA AND ATHENS IN THE SIXTH CENTURY B.C.

The Spartan State Early in the Sixth Century; Social and Political Organization	120
The Cryptea, the Ephors	121
Sparta and its Relations to the other States of the Peloponnese	122
The Peloponnesian Federal Alliance in the Sixth Century	124
Attica in the Seventh Century; the Elements of the State	125
Social and Economic Disorders	127
The Legislation of Draco; the Attempt of Cylon	127
Solon, his Life and Character	128
Conditions Demanding Social and Political Reform	129
Solon's Reforms: <i>Seisachthea</i> , the New Money Standard	130
Solon's Constitution; Classes in the Body Politic	131
The Administration of Justice under Solon	137
Conditions in Athens in the First Half of the Sixth Century	138
Pisistratus, his Attempts at Sovereignty and his Government	139
His Relation to Architecture; Art, and Poetry	141
The Pisistratidae and the Conspiracy against them; Harmodius and Aristogiton	143
The Revolt of the Athenian Commons under the Alcmeonidae	144

	PAGE
The New Constitution of Clisthenes ; Spartan Interference	145
Size of Athens at the Outbreak of the Persian Wars	150

CHAPTER VIII.

THE CONQUEST OF ASIATIC GREECE BY THE PERSIANS. — WESTERN GREECE.

Conquest of the Greek Cities of Asia Minor by Croesus	151
The Civilization, Arts, and Science of the Greeks of Asia Minor	154
Greek Poetry and Poets in the Sixth Century B.C.	155
The Persian Conquest of Asia Minor	155
The Tyrants of the Coast Cities of Asia Minor	155
Polycrates of Samos ; Pythagoras and the Pythagoreans	156
Wars in Southern Italy ; Sybaris and Croton	164
Darius in Europe and on the Danube	164
Growth of the Persian Empire	165
Factions and Dissensions among the Greeks	166

BOOK II.

FROM THE BEGINNING OF THE PERSIAN WARS TO
THE BATTLE OF MANTINEA (500–362 B.C.).

PART III.

FROM THE IONIAN REVOLT TO THE BEGINNING OF THE
PELOPONNESIAN WAR (500–431 B.C.).

CHAPTER IX.

THE PERSIAN WARS.

Immediate Occasion of the Persian Wars, — the Ionian Revolt	169
Destruction of Miletus by the Persians	172
Darius Plans the Conquest of Europe	173
“ Earth and Water ; ” Leading Men in Athens	174
The Battle of Marathon and its Consequences	176
Conditions in Athens and Sparta	180
Xerxes’s Accession and his Preparations for the Conquest of Greece	181
Advance of the Persian armies into Greece	183
The Battles of Thermopylae and Artemisium	185
The Defeat of the Persians at Salamis and its Effect	189
Victories of the Greeks over the Carthaginians in Sicily	192
Persian Operations under Mardonius	194
The Battles of Plataea and Mycale and their Results	197

CHAPTER X.

THE PERIOD OF PAN-HELLENIC UNITY (478-461 B.C.).

	PAGE
Significance of the Outcome of the Persian Wars	204
Athens Rebuilt ; the Athenian Navy	205
Further Operations against the Persians	208
Cimon ; the Confederacy of Delos	209
The Rise of Pericles, Ephialtes ; Fall of Cimon	214
Sparta ; Revolt of the Helots	215

CHAPTER XI.

THE AGE OF PERICLES (461-431 B.C.).

Attack upon the Areopagus ; the Judicial System of Athens	217
Successes of Democracy at Athens	218
Athens Aids Egypt in Revolt against the Persians	219
War between Athens and the Peloponnesian Powers	219
Reconciliation of Pericles and Cimon, Cimon's Naval Successes	223
Peace with Sparta ; Political Parties at Athens	226
Art and Literature at Athens under Pericles	227
Architecture of the Age of Pericles	228
The Acropolis of Athens and the Edifices upon it	231
Phidias and other Artists in Olympia	237
Finance and the Internal Affairs of Athens	238
The Development of the Confederacy of Delos ; the Athenian Empire	240
The Rise of the "Sophists ;" their Teaching and Influence	242
The Character and Services of Pericles	244
Athenian Comedy and the "Demagogues"	246
Party Opposition to Pericles ; his Friends Assailed	247
Discord among the Greeks ; Causes and Outbreak of the Peloponnesian War	247

PART IV.

FROM THE BEGINNING OF THE PELOPONNESIAN WAR TO
THE BATTLE OF MANTINEA (431-362 B.C.).

CHAPTER XII.

THE PELOPONNESIAN WAR.

Parties in Greece ; Sparta and Athens Opposed	251
Operations in the North	253
The Spartans in Attica ; Naval Operations of the Athenians	253
Death of Pericles ; Other Party Leaders	255
Cleon, his Character ; Comparison with Modern Demagogues	257
Progress of the War ; Siege of Plataea	259
Ionian and Dorian Feuds in Sicily	261
Sphacteria and the Athenian Successes	263

	PAGE
Brasidas and Thucydides	265
The Peace of Nicias	268
The Rise of Alcibiades ; his Character	268
Conditions in Attica and the Peloponnese after the Peace of Nicias	270
The Sicilian Expedition	272
The Mutilation of the Hermae and the Punishment of Alcibiades	273
Nicias before Syracuse	275
The Occupation of Decelea by the Spartans	276
Failure of the Sicilian Expedition	277
Operations in Asia and on the Islands	277
Parties at Athens and their Machinations	280
Alcibiades in Favor at Athens	283
The Rise of Lysander	285
The Fall of Athens	287
Literature at the Close of the Fifth Century	288

CHAPTER XIII.

SPARTAN SUPREMACY UNTIL THE PEACE OF ANTALCIDAS (404-387 B.C.).

	PAGE
The Despotism of Sparta after the Fall of Athens	291
The "Thirty Tyrants" at Athens	292
Cyrus and the Ten Thousand Greeks	296
The Spartans in Asia Minor	297
The Corinthian War ; Spartan Disasters	301
The Peace of Antalcidas	305

CHAPTER XIV.

CULMINATION AND SPEEDY DECLINE OF THE SPARTAN POWER. — RISE OF THEBES. — THE SECOND ATHENIAN CONFEDERATION.

The Olynthian Alliance Dissolved and Sparta Powerful in the North	309
Sparta's Successes in Boeotia and in Phlius	309
The Rise of Thebes ; Epaminondas and Pelopidas	310
League between Athens and Thebes ; Reforms in the Athenian Administration	312
The Second Athenian Confederation	312
The Naval Operations ; Hostilities Break out between the Spartans and the League	313
Spartan Power Threatened in Thessaly	314
The Battle of Leuctra and its Consequences	315
The Thebans in the Peloponnese	317
Humiliation of Sparta by the Thebans	319
The Battle of Mantinea and the Decline of the Theban Power	323
The Historical Writers of this Period	325
Oratory, Painting, and Sculpture	326
The Exact Sciences ; the Development of Engines of War	329
Philosophy, the Socratic Schools, Plato	332

BOOK III.

THE MACEDONIAN AGE (362-217 B.C.).

PART V.

THE MACEDONIAN SUPREMACY AND ALEXANDER'S SUCCESSORS (362-277 B.C.).

CHAPTER XV.

FROM MANTINEA TO CHAERONEA.

	PAGE
Affairs in Sicily; the Life and Work of Timoleon	337
Rise of the Macedonian Power; King Philip	338
The Macedonian Army; Philip's Political Schemes	341
Decline in the Power of Athens; the Social War	342
Disturbances in Central Greece; the Sacred War	343
Philip Interferes in the Affairs of Central Greece	345
Demosthenes, his Character and his Aims	346
Negotiations for Peace between Athens and Philip	348
Philip Enters the Phocian Territory, and is Admitted to the Amphictyonic Council	349
Development of the Anti-Macedonian Policy at Athens	350
War Breaks out between Athens and Philip	352
The "Sacred War" of B.C. 339; Philip Destroys Amphissa	354
Alliance between Athens and Thebes against Philip	356
The Battle of Chaeronea and its Consequences	356
The Congress of Corinth and the Hellenic Union under Macedonian Leadership	358
Philip's Schemes for the Conquest of Persia	359
Aristotle, Teacher of Philip and Founder of Greek Science, his Significance	359

CHAPTER XVI.

ALEXANDER THE GREAT. — THE LAMIAN WAR.

The Assassination of Philip; its Effects throughout the Ancient World	361
Alexander, his Character and Education	362
He Subdues Uprisings in Greece; Destruction of Thebes	364
Alexander Enters Asia Minor; Battle of the Granicus	365
Alexander's March through Asia Minor; the Battle of Issus	367
The Conquest of Palestine and of Lower Egypt; Alexander, "Son of Ammon"	370
Alexander Invades Mesopotamia; the Battle of Arbela	371
Alexander in Media and in Parthia	372
Anti-Macedonian Agitation in Greece; the Revolt of Agis	374
Alexandria in Bactria; he Marries Roxana	375
He Invades India and Returns to Susa	377
Death of Alexander and its Immediate Consequences	380
The Affair of Harpalus at Athens	382
Anti-Macedonian Uprisings; the Lamian War	384
War between Alexander's Generals; the Partition of his Empire	386

CHAPTER XVII.

THE AGE OF THE DIADOCHI.

	PAGE
Conditions in the Hellenic World at the Death of Alexander	387
Cassander, Polysperchon, and Macedonia	388
Cassander and Antigonus; Athens under Demetrius of Phalerum	389
Poetry, Philosophy, and Art at Athens	390
Demetrius Poliorcetes at Athens, his Naval Enterprises	391
Conditions in Sicily, Agathocles	394
The Celtic Invasion of Greece under Brennus	395

PART VI.

THE AGE OF THE EPIGONI (277-217 B.C.).

CHAPTER XVIII.

THE STATES OF THE EPIGONI.

The Diadochi Succeeded by the Epigoni	397
The Empire of the Seleucidae, its Extent and its Characteristics	397
Ptolemy and his Egyptian Kingdom	397
Macedonia and the Antigonidae; Hellenic Civilization	398
Alexandria and its Literary and Scientific Institutions	398
Alexandrine Learning, Science, and Poetry	399
The Athenian Schools of Philosophy: Academics, Peripatetics, Stoics, Epicureans	400
The Wars of the Epigoni; the Rise of Hellenistic Bactria	402

CHAPTER XIX.

THE ANTIGONIDAE, THE AETOLIANS, AND THE ACHAEANS.

The Antigonidae and their Wars in Greece	404
The Aetolians and the Aetolian League	405
The Achaean League	406
The Constitution and History of Sparta at this Time; King Cleomenes	408
War between the Aetolian League and Philip of Macedon	409
The Peace of Naupactus; the Growing Importance of Italy	410

APPENDIX.

CNOSSUS AND PHAESTUS.

Discoveries at Cnossus not made by Chance	411
Large Palace found at Cnossus	411
Walls of Palace Adorned with Paintings	411
The Agora	411
Corridor of the Procession	413
Corridor of the Cup-bearer	413
Magazines	413

	PAGE
Throne-room	413
Landscape on Walls of Throne-room	414
Upper Stories in Palace at Cnossus	414
Drains with Flush Pipes in the Upper Stories	414
Frescos in the Palace	414
Miniature Frescos	414
Costume of the Cnossians	414
Fresco Representing Bull Fight	415
Great Skill Attained by Fresco Painters	415
Porcelain Placques Representing Houses	415
Royal Gaming-board	415
Inscribed Tablets	415
Linear Script	416
About Seventy Characters in Use	416
Numerals can be Read	416
Pictographic Script	417
Pottery at Cnossus Interesting	417
Palace Destroyed about 1300 B.C.	418
Evans Thinks the Palace is the Labyrinth	418
Double Axe common	418
One Royal Tomb found	418
Phaestus Inhabited in Classical Times	418
Palace Similar to Palace at Cnossus	420
Bath-rooms in Palace	420
Mycenaean Villa at Hagia Triada	421
Vase of Black Steatite from Hagia Triada	421
Excavations on Other Sites in Crete	421
Not Known who the Mycenaeans were	421
The Egyptians called them Keftiu	421

432₇



BINDING LIST FEB 15 1929

D
20
H57
1905
V.3
C.1
ROBA

