



Deacidified using the Bookkeeper process  
Neutralizing Agent: Magnesium Oxide  
Treatment Date



AUG 1997  
PRESERVATION TECHNOLOGIES, INC.  
111 Thomson Park Drive  
Cranberry Twp., PA 16056  
(412) 779-2111







Frederick H. Wilcox

# HISTORY OF SCRANTON

## AND ITS PEOPLE

BY

COL. FREDERICK L. HITCHCOCK

Attorney at Law; late Colonel U. S. V., War 1861-1865

ILLUSTRATED

VOLUME II

LEWIS HISTORICAL PUBLISHING COMPANY  
NEW YORK CITY  
1914

COPYRIGHT, 1914  
LEWIS HISTORICAL PUBLISHING COMPANY





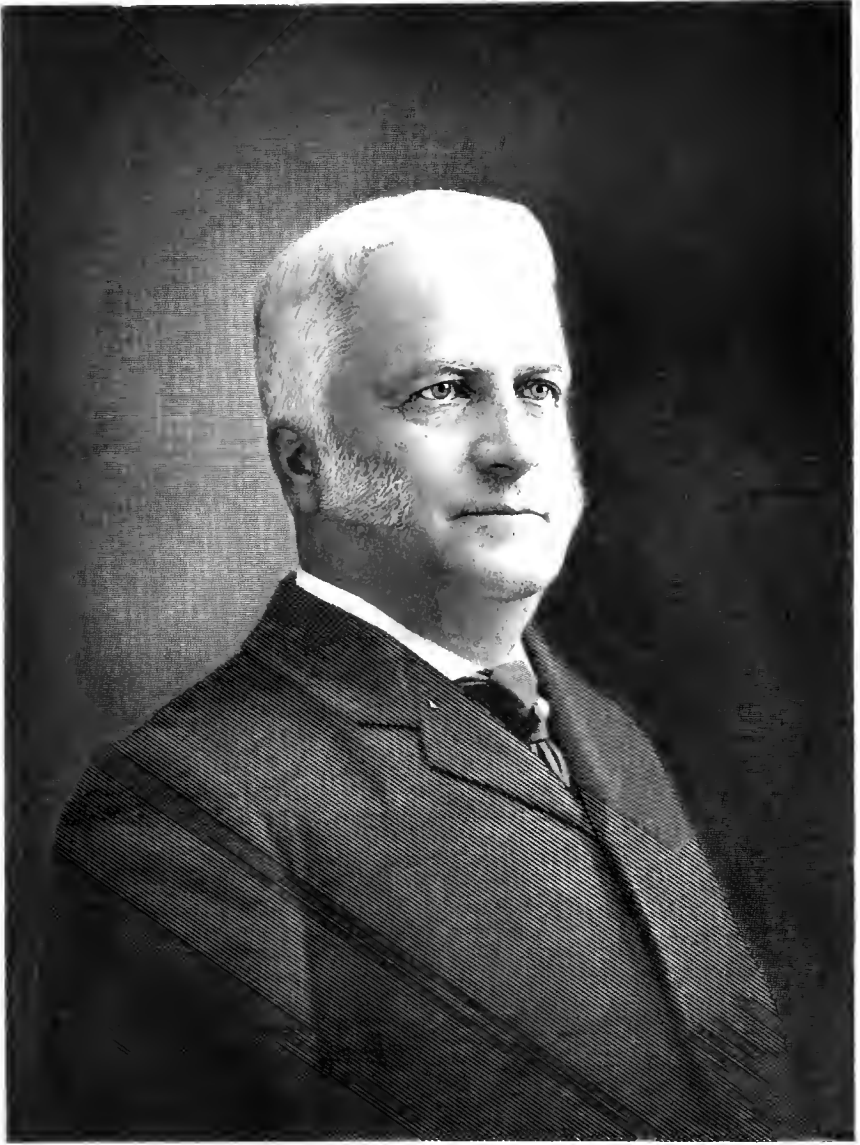

*H. W. Boies*

## COLONEL HENRY MARTYN BOIES

We have had occasion to speak of the good fortune our city had in the remarkable characters of its pioneers and founders. Remarkable in their sterling integrity, their indomitable pluck, energy and resourcefulness, that bided no defeat, stopped at no obstacle, and finally wrought success out of well nigh impossible conditions. If she was so fortunate in her pioneers, she was also fortunate in a generation of young men who followed closely upon their footsteps. The pioneers are always selected blood. This second invasion was no less so. They came from all quarters, attracted thither by conditions which promised success to such as had the courage to wrestle and win it. These are the men who build the world.

Henry Martyn Boies was one of these men. Few men had a fairer start in life than he, and none ever made better use of his opportunities. First he had the remarkable advantage of a splendid ancestry. His early paternal ancestors were Huguenots, who came to this country in the early part of the seventeenth century, and settled in New England. On his maternal side he inherited the sturdy Puritan blood of New England. On both sides his ancestors were earnest God-fearing people. In the family is preserved a remarkably written document made the 18th of April, 1738, by his paternal ancestor, David Boies, entitled "David Boies covenant with God," in which he recites his wretched and lost condition as a sinner; God's offer of salvation through Jesus Christ and his solemn acceptance of that offer and his dedication to Him. The document is singularly quaint in its language, and remarkable in being carefully drawn up, as though between earthly persons, yet it attests to the sturdy piety of its author and his strength of character. His father was Joseph Nulton Boies, who was born in Blandford, Hampden county, Massachusetts, April 20, 1809. His mother was Electa Caroline (Lafin) Boies, who was born in Southwick in the same county, Massachusetts, April 3, 1811. A friend writes of his father as being "a man thoughtful, judicious, just, generous, public-spirited, patriotic, conscientious—a man of positive convictions, who did not hesitate to express and maintain them. Through him came those forceful traits which distinguished the latter in his mature manhood; and also that philanthropic quality which made him a beloved hero among men." The same friend writes: "His mother was one of the rarest of women, in person slender, delicate, fragile, beautiful of face, and with wonderful, luminous eyes. There never was a finer human expression of tenderness, gentleness and spirituality than that manifested in the life of this good woman. She was a glorious mother, and to her influence in shaping to high ideals the career of her son, the world is indebted as to no other." With such an ancestry, it would seem as though we had every desirable element centered for the making of a man! We shall not be disappointed in its product.

Henry Martyn Boies was born in Lee, Berkshire county, Massachusetts, August 18, 1837, the first son of these notable parents. He was named for Henry Martyn, the heroic missionary to India, whose biography had just then been published. He entered Yale College in 1855, and graduated in 1859. Whether he graduated with honors, or, like General Grant, who said he would have stood near the top if they had turned the list upside down, chronicles do not show, but he had the more coveted class honor, the "wooden spoon" conferred unanimously upon him, as the best loved man in the class.

In 1865 Mr. Boies came to Scranton as a resident member of the powder firm of Laflin, Boies & Tarck, of Saugerties, New York, of which firm his father was a member. Four years before, in 1861, he had married Emma Brainerd, a sister of Thomas Brainerd, one of his college classmates, and the daughter of Rev. Thomas Brainerd, D. D., long an honored Presbyterian minister of Philadelphia. She bore him three children, one girl Mary, and two boys, Carrington and Henry Whiting. On coming to Scranton the family first lived on Spruce street, below Penn avenue. Later he built a house on Jefferson avenue, near where the Emanuel Baptist Church now stands. Here his daughter, son Carrington, and his wife, greatly beloved, passed away.

Colonel Boies entered actively into the business of making powder. His firm purchased from the Raynors a small plant at Archbald, and erected another at Moosic. The business was immediately successful and was soon greatly enlarged, and both concerns merged into The Moosic Powder Company, of which Mr. Boies became president and general manager. Its capital at first was \$150,000, which was soon made \$300,000. Colonel Boies continued at the head of this concern until it was taken over and became a part of the great Du Pont de Nemours Company of Pennsylvania. During this time Colonel Boies had made a number of inventions, one to make safe the handling of powder by the miners at their work. Familiarity with danger, it is said, breeds carelessness. This was particularly true with miners. It was not an infrequent thing, despite all admonitions, for men in the mines to open and handle a keg of powder with a lighted miner's lamp on their caps, or a lighted pipe in their mouth. The result was accidents, which often not only destroyed life, but property as well. Colonel Boies invented the prepared cartridge to meet this danger. This required first the making of a strong water-proof paper that would shield the powder from dampness in the mines, then machinery for loading the cartridge, all of which increased the cost of manufacture, and accordingly reduced the profit in the powder, but were supplied at the same price for the purpose of saving human life. The invention came into extensive use all through the anthracite region. In 1872 he helped to organize the Third National Bank and became one of its directors, which position he held for ten years. In 1883 Colonel Boies was called to the presidency of the Dickson Manufacturing Company, which position he held until 1887, when he retired. During his connection with the Dickson Company, a large part of the business of which was the manufacture of locomotives, Colonel Boies' attention was called to the failure of the existing car wheel to do its work satisfactorily, and invented and patented several designs, among them what is known as the "steel-tired" car wheel, which came into general use. He erected a plant and operated it for some years in the successful manufacture of this wheel. It was finally merged in the great concern known as the Railway Steel Spring Company; this plant, as a branch of that concern, is still in operation in our city. Colonel Boies' sudden death found him still a member of the great powder firm of E. I. Du Pont de Nemours Company. So much for the business activities of this remarkable man. As a matter of fact, and in his own estimation, these were the least important of his activities. With his Christian work and his civic activity, one wonders where he got time for business.

In 1871, at a gathering of invited friends at his house, was born the "Home of the Friendless," Colonel Boies renting the first building and assuming the cost thereof himself. In 1869-71 he was president of the Young Men's Christian Association. During this time, and until his death, he was an active spirit on its board of directors. Under his administration Mr. William D. Mossman, the first regularly paid secretary, was employed. His term and that of

Edward B. Sturges, who followed him (1869-74) may fittingly be called the fighting term of the association. Under the leadership of Colonel Boies, with the legal work of Edward B. Sturges and Cyrus W. Hartley as attorneys, both members of the board, Scranton, a "wide open town," was given a cleaning up such as it had never dreamed of. It was one of the notable events in our history. The saloon with its cognate evils was rampant in violation of all law, with municipal authorities and the public at large utterly indifferent. In their efforts to reach young men, the association was confronted with these evils, rampant, defiant and conspicuous on every hand. The fight was inevitable and gloriously it was won. One hundred and thirteen indictments were obtained against sixty-three saloon men, and after a terrific legal battle, in which all the forces of evil were met, the first conviction was obtained, and the saloon keepers surrendered. They agreed to come into court in a body, pay all costs upwards of \$1200, and enter into an agreement binding each and every one to close on the Lord's day, and obey all other laws, and to assist in securing such obedience. A great day and a great triumph was this for Colonel Boies and his two young lawyer captains, Sturges and Hartley, when these sixty-three liquor men lined up before court and entered into that agreement.

In 1874 Colonel Boies was a charter member in the organization of the Second Presbyterian Church, and was elected a trustee, which office he held until his death. He was elected a ruling elder, but declined the office. During the riots of 1877, Colonel Boies and family were out of the city. On learning of the existing troubles, he hurried home, reaching here in time to take an active part in the organizing of the Scranton City Guard, of which he was made commanding officer with the rank of major. The history of that organization will be found elsewhere with that of the Thirteenth Regiment National Guard of Pennsylvania, of which Colonel Boies was commandant for five years, from 1878 to 1883, and where he obtained his rank of colonel. In 1886, largely through his exertions, his favorite Young Men's Christian Association was handsomely housed in its own building on Wyoming avenue, where the Poli Theatre now stands. This building was largely designed by Colonel Boies, and was the most attractive Young Men's Christian Association building of that period in the state. In co-operation with his former righthand helper, Mr. Sturges, the Municipal League was formed, the objects of which were the extirpation of gambling hells and brothels and the enforcement of the liquor laws. To this work he gave freely of his time and means, and it was chiefly through this organization that our city was for many years kept practically clean of these evils.

Colonel Boies was one of the organizers and promoters of the splendid Hahnemann Hospital, erected in 1898, and was a member of its advisory board, as his wife was of its board of managers. He was active in the special work of his own church denomination, and for several years was chairman of the Presbyterian committee on work among foreign speaking people. To this missionary work he gave much time and study. His favorite achievement, the Young Men's Christian Association building on Wyoming avenue, was totally destroyed by fire in 1897. Colonel Boies' heart was bound up in this work for young men, and to him this was almost as much a personal calamity as it was to the association. To obtain that edifice with its then fine equipment had cost a mighty effort. Now all was gone, and the association homeless. The board of directors, however, met to consider the situation. Colonel Boies at once drew up a subscription paper and down went his name for a handsome sum toward a new and larger building. But they were now confronted with a need of far greater accommodations than the old building afforded. A careful

estimate was made and it was found that such a building as was needed would cost with its equipment upwards of \$250,000, and it was unanimously agreed that such an undertaking was too much for the young city of Scranton. One night's thought on the subject was sufficient for Colonel Boies. He called another conference at his office the next morning, and started the ball rolling by doubling his own subscription. It was largely through his enthusiastic work, influence and means, that the present superb and premier Young Men's Christian Association building of this commonwealth adorns our city. It is said that the great Cathedral of St. Peter's at Rome is made the monument of its builder, by a little tablet in its wall, bearing this legend, "He built this." A fine painting of Colonel Boies greets one as he enters the foyer of this splendid building. Underneath it might well have been placed the legend, "He built this."

Remarkable and diversified as were the achievements of Colonel Boies, in business, in his civic, military and Christian activity, probably his most enduring fame will rest upon his literary work, which he finished near the close of his career. This work is probably the least known of all his endeavors. He was not a fluent speaker, nor a ready writer. Whenever he had an address to make, he was careful to write it out and usually read it. It is therefore remarkable that he should finally have attained a marked degree of success in the field of literature. It was accomplished without the least ambition in that direction, and it grew out of his intense interest in the themes upon which he wrote, which came from a long period of study and service in the field of which he wrote, and his desire to benefit humanity and society by his studies.

In 1887 his personal friend, Governor Beaver, appointed him a member of the State Board of Public Charities. This board consists of eleven members, and is charged with the duty of supervising and inspecting all the charitable and penal or correctional institutions of the state. The position is one of large responsibility, but which carries with it no emoluments or compensation. It calls for men of sound judgment, broad intelligence, with a philanthropic and sympathetic nature. How he got the time with all his other work to give to this the conscientious attention it required, besides the time to study every phase of the lives of the unfortunates and the vicious which came under his observation, is amazing. He served on this commission three successive terms, from 1887 to 1902. Out of this service and experience came two books. The first, "Prisoners and Paupers" was published in 1893. The other entitled "The Science of Penology" was published in 1901. The latter soon received recognition as a work of advanced thought upon that subject. A writer, reviewing the work, says it speedily revolutionized prevailing ideas upon that subject that up to that time the punishment of crime was treated from the standpoint of retribution. A man convicted of a crime was sentenced to serve so many years' imprisonment as an expiation of suffering for the offence. Having served that time he was turned loose upon society, regardless of his character, which as a rule was more hardened and desperate because of the rigors of his imprisonment. Colonel Boies attacked this theory as radically wrong. He contended that the only proper theory of treating criminals was the protection of society, and the reform of the criminal. Hence he advocated the indeterminate sentence, and prison servitude under reforming influences; that the criminal should, for the protection of society, be kept in prison until he was proved fit to again have his freedom, and his prison life and treatment was all to be conducted with that end in view. The work was adopted as a text book by Yale University and other institutions of learning. This writer says "The Science of Penology" has admirably fulfilled the object for which it was written. It is an accurate, succinct, methodical summary of the science, a hand-book

adapted to popular use, an eminently practical work abounding in valuable learning that ought to be broadly disseminated." Again this writer says, "Mr. Boies is likely to exert an influence surpassing that of any of his contemporaries in moulding the thought and inspiring the energies of future generations with correct views regarding crime and the treatment of criminals. Thus the 'Science of Penology' must be regarded as a really monumental work, and while Mr. Boies in many ways served his day and generation, this book is the crowning work of his life, and a useful public service, which justly claims for its author a grateful and lasting memory."

Colonel Boies married as his second wife, Elizabeth L. Dickson, daughter of Thomas Dickson, the president of the Delaware & Hudson Company, February 17, 1870. Of this union there were six children as follows: Mary Dickson, died in infancy; Joseph Milton, born August 8, 1873, died April 27, 1898; a son, died in infancy; Ethel Marvine; David; Helen Elizabeth, married J. J. Belden.

Colonel Boies passed away very suddenly, December 12, 1903. He literally died in the service of his Master. Against the advice of his physician, he had undertaken a journey to Washington with Governor Beaver, and other committee men, to invite President Roosevelt to come to this city and address the Jubilee Convention of the Pennsylvania State Young Men's Christian Association, which was soon to meet here. On his way home he was seized with acute indigestion, reaching no farther than Wilkes-Barre, where he died of heart failure. So, to the great sorrow of our city, country and state, passed away one of the noblest, most patriotic, public-spirited, brilliant Christian men it has been the good fortune and the honor of our city to number among its citizens.

---

### CHARLES S. WESTON

No history of the development of Scranton, as a financial and industrial center, would be even approximately correct did it fail to chronicle the important part the Westons, father and son, have taken during the period marking its greatest advance and development. Both native Pennsylvanians, they added commercial lustre to the district and have fairly won a name on Scranton's roll of fame. While the father has gone to his eternal reward, the son remains, a vital living force in the financial and business world, honored and respected far beyond local limits and occupying the proud position as executive head of Scranton's large and solid financial institution, The First National Bank.

Edward W. Weston was born in Salem, Wayne county, Pennsylvania, December 5, 1823, died in Scranton after a long illness, October 28, 1891, son of Elijah and Minerva (Torrey) Weston. Elijah Weston was an early settler of Wayne county, while his father-in-law, Jason Torrey, was closely connected with the early business enterprises of the county.

Edward W. Weston grew to manhood in Salem, attended the country school and obtained a good education. He was his father's assistant on the farm, but also taught school and obtained a knowledge of surveying. In 1844 he attained his majority and at once left home, entering the office of his maternal uncle, John Torrey, of Honesdale, there completing his surveying and engineering studies, becoming practical and expert in both branches. He remained with his uncle, his valued assistant until 1859, when he received the important appointment of manager in charge of the lands and surveys of the Delaware and Hudson Canal Company. He was stationed at Carbondale until 1861, when he moved to Scranton, taking in charge the construction of breakers at the

new mines then being opened by the company, also directing the engineering features of the newly located mines. In 1864, upon the appointment of Thomas Dickson, as general superintendent of the Delaware and Hudson Canal Company, Mr. Weston was appointed to the position of superintendent of all their coal mining operations. The period of prosperity then setting in for the company, caused by the great expansion of their coal trade and the acquisition of valuable railroad properties, rendered it advisable to separate the company's land department from the department of mines. This was done, and in April, 1874, Mr. Weston was appointed general agent of the real estate department, which position gave him full authority over all real estate owned by the company. He efficiently filled the exacting duties of his position until February 1, 1889, when failing health compelled his retirement as the active head of that department. The company, however, were unwilling to lose his valuable services and still retained him, but in an advisory capacity. He gave freely of his best judgment and long experience on all matters affecting the real estate investments of the company until his death, his service with the company active and advisory covering a period of thirty-two years, 1859-91. Nor does this by any means cover the full extent of his services in the development of Scranton and the Lackawanna Valley. He had large private and corporate interests, and aided and promoted many of the now well known stable, industrial and financial corporations. He was president of the First National Bank, one of the soundest and most successful financial institutions in the state; president of the Northern Coal and Iron Company; of the Weston Mill Company; of the Hudson River Ore and Iron Company; vice-president and director of the Dickson Manufacturing Company; director of the Moosic Powder Company; of the Providence Gas and Water Company, and closely identified with many other manufacturing and mining enterprises both in and outside Scranton. Nor was he merely a machine for the coining of money, but public-spirited and humane, he sought to improve public conditions and leave the world better for his having lived in it. His wealth, honestly and fairly earned, was wisely used for the good of all; the welfare of his fellows and the commercial progress of Scranton, being as dear to him as were his private concerns. He possessed a character of sterling worth and exemplified in his own life the uprightness and integrity that never deviates for private gain.

Charles S. Weston, son of Edward W. Weston and his wife, Susan (Moore) Weston, was born in Carbondale, Pennsylvania, August 25, 1860. In the following year his parents moved to Scranton where his life since then has been spent. This period covers the principal years of Scranton's greatest development and of his father's greatest activity, therefore there is little wonder that his early ambition was fired to become like his father, a leading factor in his city's progress. He attended Scranton's public schools until sixteen years of age, then entered Granville Military Academy (New York). He spent two years at that institution, winning signal honors. In 1878 he entered Rensselaer Polytechnic Institute at Troy, New York; took a full engineering course of four years, and was graduated a C. E., class of 1882. Now a graduate of one of the best technical schools of the country and a fully qualified civil engineer, he entered the employ of the Delaware & Hudson Canal Company, giving that company his professional services until October, 1885, when he was appointed assistant general agent of the company's real estate department, his father then being its capable agent. When later the position of general agent was left vacant, by the retirement of Edward W. Weston, the son had so proved his value to the company that he was appointed to succeed his honored father, February 1, 1889. This position, covering as it did



the supervision of all company real estate, including mines and canals, was so ably filled by the younger man, that on the death of his father he was elected to fill the position thereby left vacant, the presidency of the Northern Coal and Iron Company, this company being owners of all the coal mines and breakers operated by the Delaware & Hudson Canal Company, south of Scranton. They also owned a railroad running from Scranton to Wilkes-Barre and were one of the most powerful of the coal owning companies of that day. Now fairly launched on the sea of business prominence the progress of Mr. Weston has been steady and continuous until the record of his activities seem almost beyond belief. He holds the following official positions: President of the First National Bank of Scranton; president of the Cherry River Paper Company, a corporation of West Virginia with offices in Scranton; director of the Lackawanna Trust and Safe Deposit Company; Scranton Lace Curtain Company; Kanawha and West Virginia Railroad Company; Cherry River Boom and Lumber Company; Hebard Cypress Company; National Water Works and Guarantee Company; the Wilson Lumber and Milling Company, and has interests in many other enterprises of not lesser importance. His elevation to the presidency of the First National Bank in 1913 was not only a compliment to the memory of its former president, Edward W. Weston, but was deserved recognition of the services of Charles S. Weston as vice-president of that bank and of his standing as a financier. While his early training had not particularly fitted him for the position, his long years of intimate connection with large undertakings had, while his high standing among men of affairs, his wide acquaintance and proven executive ability, peculiarly fitted him to become the head of so important an institution as the First National.

But there is another side to this man of large affairs. He served four years in the Pennsylvania National Guard as second lieutenant of Company H, Thirtieth Regiment. He is a member of many associations, societies, clubs and fraternities, thoroughly enjoys the social side of life and the company of his professional brethren, friends and neighbors. He is interested not only in the material prosperity of his city, but in her churches, hospitals and philanthropic institutions, serving them with purse and personal service. A Republican in politics, he is strong in his support of good government, and while helpful in the service of his friends has never sought public office for himself.

Mr. Weston married, September 2, 1891, Grace Storrs, born in Buffalo, New York, a graduate of Wells College. She is the daughter of the late W. R. Storrs, general coal agent of the Delaware, Lackawanna & Western Railroad Company. The family home of the Westons is on Monroe avenue, Scranton, where a gracious hospitality is dispensed.

---

#### JUDGE ALFRED HAND

To few men has it been given to occupy as commanding a position in the affairs of his section, and the hearts of the people, as to Judge Hand, lawyer, jurist and business man. A review of Judge Hand's career shows him, not only as a brilliant lawyer, wise judge and excellent business man, but shows him as the interested trustee of educational institutions, president of a school devoted to the education of deaf mutes, active in Young Men's Christian Association work, in the prosperity and government of his church and an ardent supporter of all that pertains to the public good. Now nearing his eightieth year (1914) Judge Hand can look back over a most useful life and surely the review can give him nothing but satisfaction.

(I) Paternally, Judge Hand descends from John Hand, of Stanstede, England, who came to America in 1644, and maternally from Robert Chapman of

Hull, England, who settled at the mouth of the Connecticut river in 1635. John Hand, in 1648, settled at Easthampton, Long Island, going there from Southampton, where he is listed as a "whaler." From him descends a long line of ship builders and seafaring men, whose names are yet familiar on Long Island. From Long Island, a branch of the family located at Athens, Greene county, Judge Alfred Hand descending from this branch. The line of descent from John Hand, the emigrant, is through Stephen (1), died 1693; Stephen (2), born 1661, died 1740; John, baptized 1701, died 1755; John (2); John (3), born 1754, in Athens, Greene county, New York, married, March 6, 1778, Mary Jones, and died May 30, 1809.

(II) Ezra Hand, son of John and Mary (Jones) Hand, was born August 9, 1799, in Albany county, New York, died in Honesdale, Pennsylvania, in 1875. In early manhood he settled in Honesdale, where the greater part of his life was passed. He married, June 2, 1829, Catharine Chapman, born at Durham, Greene county, New York, February 11, 1808, who survived him, attaining the great age of ninety-one years. She was a lineal descendant of Robert Chapman, who in 1635, came from Hull, England, landing at Boston, but the following November was one of the company of twenty-one men, sent out by Sir Richard Saltonstall to make settlement at or near the mouth of the Connecticut river under the patent of Lords Say and Seal. Thus does Judge Hand's title prove clear to colonial New England ancestry on both paternal and maternal lines.

(III) Alfred Hand, son of Ezra and Catharine (Chapman) Hand, was born at Honesdale, Pennsylvania, March 26, 1835. Preparing in local schools, he entered Yale College at the age of eighteen years, whence he was graduated, class of 1857. Returning home he decided upon the profession of law, entering the offices of William & William H. Jessup, of Montrose, Pennsylvania. He was admitted to the bar of Susquehanna county in November, 1859, and to the Luzerne county bar, May 8, 1860. He was for a short time a member of the law firm of Jessup & Hand, but in 1860 moved from Montrose to Scranton, where he practiced alone for six years, then admitting to partnership a former fellow law student, Isaac J. Post. This association continued until 1879, when, by appointment of Governor Hoyt, Mr. Hand was elevated to the bench, as judge of the Eleventh Judicial District, composed of the counties of Lackawanna and Luzerne. He had taken active part in the foundation and early history of Lackawanna county, therefore, when the new judicial district was erected, he was appointed its first judge of the Court of Common Pleas. The following year, 1880, he was regularly elected for the full term of ten years. However, he did not complete but eight years of his term, as on July 31, 1888, he was appointed by Governor Beaver to a seat upon the Supreme bench of Pennsylvania, to fill the unexpired term of Judge Trunkey, deceased. He served with honor until the expiration of his term, January 1, 1889, then retiring to the private practice of his profession, after ten years upon the county bench and upon that of the Supreme Court of his state. He won legal honors as a jurist, and was regarded in point of learning, legal acumen and soundness of judgment, as the peer of any of his Supreme Court colleagues. As a private practitioner Judge Hand was very successful and had a well earned reputation as the leading lawyer of the Lackawanna county bar at the time of his retirement. He made a specialty of corporation law and was counsel for many of the important corporations of Scranton. His practice was a large one and was held closely to him by virtue of his fully recognized ability as an attorney and an advocate. While always a Republican, Judge Hand never sought office, nor did he even accept any save judicial ones. But large as was his practice, he yet had time for other business activities and

civic obligations. From 1872 until 1879, he was president of the Third National Bank of Scranton and was instrumental in the organization of the First National Bank. He held directorships in the People's Street Railway of Luzerne county, the Jefferson Railroad Company, the Dickson Manufacturing Company, the Lackawanna Valley Coal Company, the Oxford Iron and Nail Company, the Davis Oil Company of New York, and was a member of the coal firm, William Connell & Company. This proves Judge Hand's claim to the title of a "busy" man, but gives no idea of the time devoted to the institutions in which he was particularly interested as a humanitarian and good citizen. He was trustee of Lafayette College, president of the Pennsylvania Oral School for Deaf Mutes (the first school of its kind ever established in the State); was president of the Scranton Free Library from its foundation; president for many years and an active worker of the Lackawanna County Bible Society, director of the Lackawanna Hospital, director and president of the Scranton Young Men's Christian Association. In none of these bodies was he a figurehead, but gave them his best effort, and all were successfully conducted during Judge Hand's connection with them.

In his religious life, he has been very active, useful and earnest. In 1867 he was elected an elder of the First Presbyterian Church of Scranton, continuing as such for over forty years. He has represented the Lackawanna Presbytery in six General Assemblies of the Presbyterian church, serving on important committees and taking active part in the deliberations of the assembly.

So all through his life Judge Hand has been active and useful in every department of life, and to few men has it been given to see greater good follow their labors. He holds a secure place in the hearts of his brethren of the bar, his business associates, his brethren of the church and kindred organizations, and in the hearts of his fellow citizens. He belongs to many bar associations, societies and organizations of different kinds and now with his books, his friends and his memories, passes the closing years of an honorable, useful life.

Judge Hand married (first) September 11, 1861, Phoebe A., daughter of the distinguished jurist, William Jessup of Montrose, Pennsylvania, under whom Judge Hand received his first legal instruction. She died April 25, 1872. He married (second) Helen E., daughter of Frederick Sanderson, of Beloit, Wisconsin. His children are: 1. Horace E., of Anaheim, California, graduate of Yale, class of 1884. 2. William Jessup, graduate of Yale, Bachelor of Arts, 1887; read law with his father and on the latter's retirement from the bench became his law partner; for twelve years was a director and for two years president of the Young Men's Christian Association; served as councilman of Scranton and on the school board as a Republican. 3. Alfred, graduate of Yale, 1888, and of the medical department of the University of Pennsylvania, whence he was graduated M. D., establishing in practice in Philadelphia. 4. Harriet J. 5. Charlotte C. 6. Miles T., graduate of Williams College and Cornell University. 7. Helen S., wife of Dr. John Lyman Peck. 8. Ruth B.

---

#### BENJAMIN H. THROOP

While there are interesting traditions concerning the English ancestry of William Throope, the Puritan, there is so much that is both true and interesting in the lives of his descendants that the traditional may properly be omitted. In the earliest settlement of Scranton, beginning with Slocum Hollow days, two men who were destined to be of great service, seem to have been first drawn to the new settlement by the fact that they had married relatives. Dr.

Throop married Harriet F. McKinney, Sanford Grant married Mary McKinney, a sister of Harriet McKinney.

(I) Dr. Throop, the founder of the Scranton Throops herein recorded was a descendant of William Throope, the Puritan who married in Barnstable, Massachusetts, May 4, 1666, Mary, daughter of Ralph Chapman, who came in the "Elizabeth" in 1635. William Throope later was one of the first settlers of Bristol, Rhode Island, traveling there overland prior to 1683, with his family in an oxcart. He was grand juryman at Barnstable 1680, surveyor of highways at Bristol 1683, selectman 1689, grand juryman 1690, representative 1691, died December 4, 1704.

(II) Captain William (2) Throope, son of William Throope, the Puritan, born about 1678-79, is the Captain William Throope of Lebanon, Connecticut, who was elected representative 1730, justice of the peace 1736, moderator at town meetings and captain of militia. He was land agent for the proprietors at Lebanon and acted for the colony on numerous occasions in the settling of boundary disputes, etc. He married at Bristol, March 20, 1698, Martha Colyn.

(III) Rev. Benjamin Throop, youngest son of Captain William Throope, was born at Bristol, Rhode Island, June 9, 1712; was a graduate of Yale 1734, studied theology and was pastor of the church he organized at Bozrah, Connecticut, from January 3, 1738, until his death, September 16, 1785; chaplain of the Crown Point Expedition in 1755; appointed to preach election sermon May, 1753, which was printed by the order of the legislature. He married, September 27, 1735, at Canterbury, Connecticut, Sybil, daughter of Colonel John and Abigail (Fitch) Dyer, and granddaughter of Major James Fitch, the patron of Yale, and his wife, Alice, daughter of Major William Bradford, eldest son of Governor Bradford. Miss Caulkins, the historian, says of Rev. Benjamin Throop: "He left behind him the reputation of a scholar and a gentleman, seasoning all his speech with a divine relish, yet genial, social, always diffusing good humor, always thirsting for information and ever ready to impart from his ample store to others." He died at Bozrah, September 14, 1785, his wife August 1, 1793. His funeral sermon by Rev. Andrew Leete, Yale, was published. An item in his will reads "to my son Horace Throop my Gun and the rest of the artillery," to other children he left, "books and great Bible," "my silver tankard," "Sermons," "Negro boy Jack."

(IV) Colonel Benjamin Throop, fifth child of Rev. Benjamin Throop (the final "c" was dropped in the preceding generation), was born March 9, 1744, died in New York State, June 16, 1822. He responded to the Lexington alarm as lieutenant and his commission as colonel of the Fourth Regiment Connecticut Volunteers, signed by John Jay, secretary of the Board of War in Philadelphia, March 9, 1779, was owned by Dr. Benjamin H. Throop of Scranton. Colonel Throop was brevetted for gallantry, and received a grant of land in Ontario county, New York, as bounty and half pay for life, \$240.00 a year from April 20, 1818, as pension. Dr. Throop, before mentioned, wrote of him under date of October 20, 1896: "He was major of the Fourth Connecticut Volunteers and with his regiment and three others, was ordered to New Jersey and Pennsylvania—spent the winter at Valley Forge and one at Morristown; was at the battles of Trenton, New Brunswick and Germantown, and then with Sullivan was ordered by Washington to drive the Six Nations of Indians to their homes in Oneida county, from which they came down to the Wyoming Valley, now Luzerne county. With General Sullivan he drove them home, and after that landed at West Point on the Hudson and was in several battles on that river. That ended his first enlistment. He re-enlisted and was in various fights even to Montreal." He moved about 1800 to Red Hook, Dutchess county, New York, and about 1816 to Chenango county, New York. He mar-





*Bishop M. A.*

ried at Lebanon, Connecticut, April 4, 1766, Susannah, daughter of his father's first cousin, Captain Dan and Susannah (Cary) Throope, and sister of Captain Dan (2) Throope of the Revolution.

(V) Major Dan Throop, eldest son of Colonel Benjamin Throop, was born April 27, 1768, died at Oxford, New York, May 18, 1824, and was buried with military honors. He is buried with his wife in the cemetery there, the spot marked by a fine monument erected by his son, Dr. Benjamin H. Throop. Major Dan Throop served in the Revolutionary War, first entering the army when fifteen years of age, marching with his father's regiment as a fifer, and was pensioner of the government in his old age. He married, November 12, 1788, Mary Gager, of Bozrah, Connecticut. In 1792 they sold land in Norwich "inherited from our Honored Father and Mother late of Bozrah" and moved to Oxford, New York. His eldest son, Captain Simon Gager Throop, was a brilliant, popular lawyer of Oxford, captain of militia, member of assembly and paymaster in New York, died in Honesdale, Pennsylvania, in 1880. Mary (Gager) Throop died in 1842 aged seventy-three years.

(VI) Dr. Benjamin Henry Throop, sixth child and youngest son of Major Dan and Mary (Gager) Throop, was born at Oxford, New York, November 9, 1811, died at Scranton, Pennsylvania, June 26, 1897. The lad attended Oxford Academy, where among his classmates was Horatio Seymour, later governor of New York state, and Ward Hunt. Finishing his academical course he began the study of medicine under Dr. Percy Packer, afterward entering Fairfield Medical College, then the only medical college in the state. He was graduated M. D. in 1832, being then twenty-one years of age. In February of the same year he settled at Honesdale, Pennsylvania, then an insignificant village, located at the head of the Delaware and Hudson Canal. He remained there until 1835, then located in Oswego, New York, and in 1836 in New York City. He remained in New York City until 1840, and in the early fall of that year visited old friends in Honesdale. While there he was called in consultation by a physician of the Lackawanna Valley and so favorably did the locality impress him, that on October 8, 1840, he was established in Providence.

In 1842 he married, his wife being Harriet F. McKinney, a sister of the wife of Sanford Grant, a member of the firm of Scranton & Grant, which was the first business firm to locate in Slocum Hollow, and from whose early efforts grew the city of Scranton. Through this relationship, the doctor became acquainted with the possibilities of the location and in 1847 he was persuaded to settle at the "Hollow." He chose a home lot in the woods and erected a house, the first ever erected in Scranton proper, except those built by Scranton & Grant, as part of their iron making plant. He soon became known throughout the Valley as a skillful physician, and had a large practice. In 1853 he was appointed postmaster, holding the office for two years. In 1835, Dr. Throop having become convinced that coal was to be the great source of the Valley's wealth and mining, its chief industry, began investing in land underlaid with anthracite coal. He kept increasing his holdings until, when railroads finally came and large coal companies began their operations, he found himself a very wealthy man. He continued one of Scranton's active business men, owned a great deal of real estate, including additions to the city in Hyde Park, Providence, and on his own land laid out the town of Blakely, the village of Priceburg, and founded the town of Throop. He purchased nearby farms, divided them into lots, and sold them at reasonable prices, but at a handsome profit. He supervised the completion of the Newton turnpike, introduced the first public milk supply, the first drug store, the first livery stable, the first railway package express company. He was instrumental in securing the first post office and was postmaster 1853 to 1858. When later the county of Lack-

awanna was erected from Luzerne, it was Dr. Throop who worked the hardest to bring about the separation, he having agitated the question of division for years, spending a great deal of time in Harrisburg in the pursuit of friends for the measure.

He was the first surgeon in old Luzerne county to respond to President Lincoln's call, receiving unsolicited a commission as surgeon from his friend, Governor Curtin. He kept his men in excellent health and was the first surgeon in Pennsylvania to establish a field hospital. This was a necessity, as the 10,000 men there quartered, drawn from different states, and living under unusual conditions, developed a great deal of sickness. Dr. Throop, as the senior surgeon, was expected to provide suitable quarters for these men and he did, by seizing an abandoned hotel and the city hall, filling them with cots, which he furnished at his own expense, bedding being sent in from Scranton. He had left home expecting to be away for a day or two, but it was only at the end of four months of active service in the field that he was free to return to his home. Soon afterward he was again ordered to the front, where he served as surgeon of the One Hundred and Thirty-second Pennsylvania Infantry, being ordered to the relief of that regiment, after they had been badly cut up at the battle of Antietam. There he established a field hospital in the woods, and remained in charge six weeks. He then accompanied the army to Harper's Ferry, remaining there until an attack of fever compelled his return home. It was not until after the war ended that the good doctor gave up his practice, but from that time until his death he devoted himself to his extensive business interests and to the many plans he had formed for the betterment of his fellow men. All through his life he continued his deep interest in the church and it was largely through his influence and assistance that St. Luke's (Episcopal) Parish was able to erect their beautiful church edifice. He aided in organizing the first lodge of Independent Order of Odd Fellows in Scranton, aiding also in the erection of their first hall, which was also used for lectures and entertainments. He was one of the presidents of the Scranton City Bank, president of the Scranton Illuminating, Heating and Power Company, and was relied on for generous support in the establishment of every laudable enterprise.

Though long retired from practice, he never lost interest in the medical profession. He was a warm friend of the young doctors and the Lackawanna Medical Society was enriched by a gift of 200 volumes for their library. He was appointed October 13, 1873, by Governor Hartranft, a trustee of the State Hospital for Insane at Danville and was continued in that position by succeeding governors, being reappointed as follows: In 1878 by Governor Hartranft; 1879, by Governor Hoyt; 1882, 1883 and 1885, by Governor Pattison; 1888, by Governor Beaver; 1891 and 1894, by Governor Pattison; 1895 and 1897, by Governor Hastings. He founded Lackawanna Hospital and maintained it at his own expense until in 1874 the state assumed its control. During many of his long years of private practice, he was chief surgeon for the Delaware & Hudson and the Delaware, Lackawanna & Western Railroad companies. Politically he was a Republican, but never sought or accepted public office. In medical practice he was allopathic, yet independent and liberal in his views of the merits of other schools. He was a great reader and deep thinker, wrote a deal for the medical journals and for the newspapers. He collected and arranged a great deal of historical data concerning Scranton's early history, much of it having, since his death, been published. He was broad in his religious views and possessed an uprightness of character that won him the unvarying respect of his associates. In the broadest and best sense, his was a successful life. Very few of his contemporaries are now left on the scene of



of action, but these few speak in the highest praise of Dr. Benjamin Henry Throop and his great service to Scranton as hamlet, borough and city.

He married, January 19, 1842, Harriet F. McKinney, born at Ellington, Connecticut, January 31, 1817, died May 20, 1868. Children: 1. Mary E., born March 4, 1844, married, June 20, 1866, Horace B. Phelps, born June 23, 1842, died November 21, 1881. Mrs. Phelps survives her husband, a resident of Scranton. 2. Eugene Romaine, died young. 3. Benjamin Henry (2), died young. 4. William Bigler, died young. 5. George Scranton, of whom further.

(VII) George Scranton Throop, youngest son of Dr. Benjamin Henry Throop, was born in Scranton, September 9, 1854, died there March 23, 1894. He graduated from Jefferson Medical College, Philadelphia, as an M. D. and practiced medicine a few months but gave it up in a short time and went into business with his father, who at this time was active in real estate and coal projects, George S. Throop taking care of the actual supervision and outside work for his father. George S. Throop was a Mason, Knight Templar, Odd Fellow, and was the first exalted ruler of the local branch of Elks; was active in forming the volunteer fire department and later the paid department. He married Jennie Wall, of Tunkhannock, January 3, 1889; she died July 12, 1893, her two months' old baby died a few days later.

(VIII) Benjamin H. Throop, son of George Scranton and Jennie (Wall) Throop, was born in Scranton, Pennsylvania, December 22, 1889. He obtained a practical education by attendance at the Hills School, Pittston, Pennsylvania, and Harstrom School, Norwalk, Connecticut, graduating from the latter institution in the class of 1911. His active career, so far, has been devoted to dairying and stock farming, in which he has been eminently successful, conducting his operations on a farm consisting of 350 acres of improved land located in Elmhurst, Pennsylvania, of which he is the owner. For dairy purposes he has in his possession about seventy cows, full blooded Guernsey stock, which yield a large amount of milk and which he keeps in a thoroughly scientific manner, paying particular attention to sanitary conditions. He also pays special attention to the raising and training of German Shepherd dogs, which he trains for police purposes, which have the reputation of being the best bred and trained dogs in the world, having taken several prizes at the dog show held in New York City, March, 1913. There is a great demand for these dogs throughout the entire country. During his brief business experience Mr. Throop has displayed ability of a high order, which, coupled with progressive ideas, perseverance and persistency, will win for him a position among the representative business men of his section of the state. He is a member of the directorate of the Union National Bank, Scranton Trust Company, and Young Men's Christian Association, in all of which he takes a keen interest and leading part. He is a Republican in politics.

Mr. Throop married, June 26, 1911, Margaret E. Connell, daughter of Dr. Alexander J. and Fannie (Norton) Connell, a sketch of whom appears elsewhere in this work. Mr. Throop is a member of the Episcopal church, Mrs. Throop of the Methodist church.

---

#### THEODORE G. WOLF

From the Palatine of Germany, prior to the Revolution, came an emigrant who settled in Allen township, Northampton county, Pennsylvania. He was a true Teuton, industrious and thrifty, with a well stored mind and a strong desire to have his sons obtain all the benefits of education. To one of these sons, George, Northampton county and the State of Pennsylvania owe much

of their educational prominence, for as clerk of court, lawyer, legislator and chief executive of Pennsylvania, his influence was always given to the cause of education in general and free public education in particular, he being in truth the father of the public school system in Pennsylvania. In the next generation a grandson of the German emigrant became one of the leading journalists of Northeastern Pennsylvania, advocating in his papers, with all his force, the cause not only of education, but that of good government and righteousness in the body politic. In the third American generation a great-grandson of the emigrant and grandson of Governor Wolf is found among the leading men in the Lackawanna Iron and Coal Company, that first and greatest of early corporations and one inseparably associated with the development of Slocum Hollow to the great Scranton of half a century later. Although Theodore G. Wolf has not been associated with the company since 1900, he was for thirty-eight years a factor in their prosperity and only severed his connections to assume greater responsibilities imposed upon him by the last will and testament of another of the honored pioneers of Scranton, Dr. Benjamin Throop. Probably no family in its first three generations has produced three men whose lives were more completely lived in the service of their fellow men, than those whose careers are herein traced, but each in a different field.

(II) George Wolf, seventh governor of Pennsylvania, was born in Allen township, Northampton county, Pennsylvania, August 12, 1777, son of the German emigrant. He was educated at a classical school in the county, presided over by Robert Andrews, A. M., a graduate of Trinity College, Dublin. After finishing his classical course, including a good knowledge of Latin, Greek and the sciences, he returned to the home farm, of which he took charge. He also was principal of the Allen Township Academy, but the law was his goal. He obtained a position in the prothonotary's office at Easton and at the same time read law under the direction of Hon. John Ross. The young man early espoused the principles of Thomas Jefferson, who, when he became president, appointed Mr. Wolf postmaster of Easton. He was later appointed by Governor Thomas McKean clerk of the Orphans' Court of Northampton, a position he held until 1809. In 1814 he was elected a member of the Pennsylvania house of assembly, ran for state senator the following year, but unsuccessfully. In 1824 he was elected to Congress, was twice re-elected and was known as a hard worker, a conscientious, upright member. In 1829 he was elected governor of Pennsylvania. He had previously been admitted to the bar and had a well established lucrative practice, which he abandoned to assume the high office of governor. He came to the office at a time when the great schemes of public improvement had caused the placing of an immense debt upon the state and vast sums were needed to complete them or lose the amount already invested. State finances were in a deplorable condition, the revenues being insufficient to meet even the interest on the debt already contracted. The outlook was very gloomy, but Governor Wolf took the bold ground that the improvements must go on, and in his first message to the legislature recommended in strong language the vigorous prosecution of the public works and the adoption of a system of taxation by which funds would be realized to pay interest on past loans and such as it was still necessary to create. He received the approval of the public and the great work of uniting the eastern waters of Pennsylvania with the western and the rivers of central Pennsylvania with Lake Erie was vigorously prosecuted.

But the greater fame of Governor Wolf rests upon his strong advocacy of a system of popular education. James Buchanan said in a speech delivered at West Chester, previous to Governor Wolf's election:

If ever the passion of envy could be excused a man ambitious of true glory, he might almost be justified in envying the fame of that favored individual, whoever he may be, whom Providence intends to make the instrument in establishing Common Schools throughout this Commonwealth. His task will be arduous. He will have many difficulties to encounter, and many prejudices to overcome; but his fame will exceed even that of the great Clinton, in the same proportion that mind is superior to matter. Whilst the one has erected a frail memorial, which like everything human must decay and perish, the other will raise a monument which shall flourish in immortal youth and endure whilst the human soul shall continue to exist. Ages unborn and nations yet behind shall bless his memory.

To George Wolf that honor was accorded and to him, in all time to come, when the inquirer shall seek to know by whose voice and sturdy will the cause of public education was championed and finally won, shall the praise be given. While former governors had noticed and favored the measure, nothing substantial had been accomplished. Governor Wolf made the adoption of a public school system the special object of his ambition and the cherished purpose of his administration. He not only advocated the measure in public and private but put his own shoulder to the wheel and with iron will yielded to no temporizing, and ere he laid aside the office of governor had the honor and great pleasure of signing a bill, making the first step towards the establishment of a free system of public education in this state: the levying of a tax for a school fund, passed by both branches of the legislature at the session of 1834. George Wolf was the first chief executive of Pennsylvania to establish his office in the State Capitol, previous executives having had their offices in their private residences. He kept regular, punctual hours, cordially received all callers, and in the dispatch of the immediate business of his office kept no clerk.

He warmly supported President Jackson in his conflict with the South Carolina nullifiers, but did not approve the president's action in refusing a charter to the United States Bank and crushing out that institution. Twice elected to the office of chief magistrate of the Keystone State, Governor Wolf was defeated for a third term. In the following year he was appointed by President Jackson to the responsible position of first comptroller of the treasury of the United States. For two years he acceptably filled this high office, then resigned to accept from the hands of President Van Buren the office of collector of the port of Philadelphia. He died very suddenly, while yet in the vigor of his manhood, March 11, 1840, aged sixty-three years. He held the governor's office from December 15, 1829, until December 15, 1835. His chief attributes were sterling integrity, sound judgment, strong common sense with a firmness that spurned dictation. As a lawyer he was noted for attainments of a solid rather than a brilliant character and was an unerring judge of human nature, one of Pennsylvania's strongest executives and one of the many great men of our state that we owe to our foreign-born sons.

(III) Edward L. Wolf, son of Governor George Wolf, was born in Easton, Pennsylvania, and after a life of great usefulness died at Scranton in 1881, aged sixty-five years. He embraced the profession of journalism and from early life until death he held important connection with the press of this section of Pennsylvania. Among the more important journals with which he was connected as editor and publisher may be named the *Easton Sentinel*, *The Backwoodsman* at Honesdale and two papers in Stroudsburg, Pennsylvania. In 1872 he came to Scranton, as political editor of the *Republican*, continuing in that position until his death. He was a strong writer and his editorials were noted for their great effect in molding the public opinion. He was a member of Barger Lodge, Free and Accepted Masons, of Stroudsburg, also belonged to the Independent Order of Odd Fellows there.

He married Mary G. Throop, daughter of Simon Gager Throop, of Ox-

ford, New York, a lawyer and a classmate of President Martin L. Van Buren. Both Mr. and Mrs. Wolf were members of the Methodist Episcopal church. Seven of their eleven children grew to years of maturity: Theodore G., Hannah M., Edward L. (2), Frederick, George E., Mary, R. B. Duane.

(IV) Theodore G. Wolf, eldest son of Edward L. and Mary G. (Throop) Wolf, was born in Easton, Pennsylvania, May 26, 1844. His early education was obtained in the public schools of Honesdale and Stroudsburg, finishing his studies at Scranton high school. He began business life as office boy with the Lackawanna Iron and Coal Company, January 1, 1862, and for thirty-eight years was continuously in the service of that great company, advancing rapidly from promotion to promotion. The only break in his thirty-eight years of continuous service was the forty days of military duty he performed in 1863. He did not long remain in an office position, but soon went into the rolling mills, served a regular apprenticeship and about 1868 was made foreman of a department. In 1872 he was appointed superintendent and in 1888 general superintendent of the rolling mills. Mr. Wolf had gained the entire respect of the officials of the company, and had justified their confidence in him by administering the duties and responsibilities of his position wisely. He was master of his business in every detail and while the great Lackawanna Coal and Iron Company has ever been well officered and managed, its interests were never better cared for than by Mr. Wolf during his years of authority.

In 1896 he was named in the will of Dr. Benjamin H. Throop as one of the executors of his vast estate. For four years he acted as executor in connection with his duties as superintendent of the rolling mills, but in 1900 resigned the latter office and has since devoted himself entirely to the Throop estate and his private corporate concerns. He is a director of the Allentown Portland Cement Company, the Pittston Slate Company, the Nordmont Chemical Company, the Luzerne Chemical Company and the Wyoming Chemical Company. His connection with the First National Bank of Scranton is most interesting, he being the only person now living who was connected with the bank in 1862. His service was as acting teller for a time. Mr. Wolf's military service was as a private in Company A, Forty-first Regiment Pennsylvania Militia, enlisting June 30, 1863, and remaining in the service forty days. He is a member of Peter Williamson Lodge, Free and Accepted Masons, and a member of St. Luke's Episcopal Church, which he has served as vestryman for twenty-one years.

Mr. Wolf married Elizabeth E. Foulke, daughter of Charles M. and Catherine Foulke, the latter named a prominent speaker of the Society of Friends. Their only son, W. Scranton Wolf, born in 1872, is a resident of Scranton.

---

#### JOHN T. DUNN

Inheriting the virile qualities of a Scotch-Irish ancestor, who fought in the Revolution, John T. Dunn rightfully possesses the qualities that have made the name of Dunn a noted one in the legal annals of Chemung county, New York, and Lackawanna county, Pennsylvania, his grandfather, Judge James Dunn, having been a leading light of the former bar, while the firm of Dunn & Dunn—Arthur and John T. Dunn—occupy a no less important position at the bar of Lackawanna county.

(I) The Scotch-Irish ancestor, John Dunn, was a Revolutionary soldier from Connecticut, who married and had a son, William.

(II) William Dunn, a son of John Dunn, also served in the Revolutionary War from Connecticut, later settling in Elmira, New York, where he lived on

Water street, east of Sullivan, there being now no trace of his residence. He first engaged in merchandising, and later was for several years a proprietor of the "Black Horse" tavern in Elmira, at the corner of Lake and Water streets. He lived for a time in Bath, Steuben county, New York, where some of his children were born. Later he settled in Chemung Valley, New York, where he built the first grist mill in association with Judge Payne. He lived to be ninety years of age. His widow married (second) John Davis, although very much his senior. William Dunn was made a Mason in August, 1793. He had several sons, all of whom became politically prominent. Charles W., the eldest, is said to have been the first white child born in Bath, but passed most of his eighty-five years in Chemung county, a merchant and landlord, proprietor for many years of the Franklin House at Horseheads, New York. Thomas, another son, was a merchant, and married a daughter of Dr. Elias Satterlee.

(III) William (2) Dunn, son of William (1) Dunn, was an unusually brilliant young man and one of the finest of public speakers. He was an ardent Whig and a great admirer of Henry Clay, whom he greatly resembled in face and figure. He was born in 1802; married in February, 1825, Murilla Hulburt, of Cornwall, Connecticut, died December, 1850, the result of an injury from a piece of falling cornice at a fire in Elmira, near the Lake street bridge. He was collector of customs and one time held a department position in Washington.

(IV) Judge James Dunn, youngest son of William (2) Dunn, gave promise from early manhood of becoming one of the notable men of the county. He was educated in the public schools, and about 1822 began the study of law with Aaron Konkle. He was admitted to the bar of Chemung county in 1825 and was subsequently a member of the law firms of North & Dunn, Dunn & Hathaway and Dunn & Patterson. He was the second elected "First Judge" of Chemung county, serving from 1844 to 1846. In his prime he was looked upon as possessing a strong legal mind, and was numbered with the ablest men of his profession. He measured swords with many of the brightest lawyers of his day and won many notable legal battles. In 1840 he was the candidate of the Whig party for Congress, but the district being strongly Democratic, he was defeated. For many years he was the acknowledged Whig leader in Chemung county, having for his trusted friends such men as Seward, Weed, Greeley, Charles Cook, John C. Clark and others. In 1848 Judge Dunn supported the candidacy of his old time antagonist, Martin Van Buren, for the presidency, "bolting" his own party ticket in favor of the Free Soil Democrat. In 1852 he supported General Scott and became an earnest and active Republican, holding extremely radical views on the slavery question. During the stormy reconstruction days, he acted with the Democratic party, although his last vote was for President Hayes. He died May 1, 1877.

The resolutions of respect from the Chemung county bar tell of the high esteem in which he was held. Said Ariel S. Thurston, at a meeting of the bar held May 3, 1877: "At the time of his death Judge Dunn was with one exception the oldest member of the bar within the limits of the old county of Tioga. He was too, I believe, the oldest native born citizen of the city of Elmira residing within its limits. He was most genial and companionable in his manner, somewhat sarcastic; a man of broad humor and quick repartee; always enjoying a joke and with his friend, James Robinson, was often wont to set the table in a roar. In the argument of a legal proposition, he was by no means an antagonist to be trifled with."

Judge Dunn married, April 28, 1827, Eliza Thompson, of Goshen, Connecticut. Just three days prior to the death of Judge Dunn, they celebrated their golden wedding. He was survived by his widow and sons, D. Thomp-

son, Henry and Isaac B., the two former then residents of the State of Georgia. He also left two daughters, wives of Frank A. Atkinson, of Elmira, and Thomas Root, of Philadelphia.

(V) Isaac B. Dunn, son of Judge James Dunn, was born in Elmira, New York, in 1846. He was educated in the public schools. He entered the public service of his country, was examiner of pensions and remained in government position until his death. He was a member of the Presbyterian church and of the Masonic order. He married Georgianna Frances, daughter of John Tatham, of English ancestry, his family early settling in Virginia. Three children of Isaac B. Dunn grew to years of maturity: 1. John T., of whom further. 2. Eliza, married Dr. William Carver Williams, of Chicago. 3. Arthur, born in Elmira, New York, March 7, 1873; graduate of Princeton University, class of 1895; read law with Judge Alfred Hand, was admitted to the Lackawanna county bar in September, 1895, practiced alone until 1900, when he admitted his brother, the firm becoming as now, Dunn & Dunn; he is president of the Scranton Real Estate Company and of the Fidelity, Mortgage and Securities Company; he married Augusta Pratt Fordham and has children: Arthur, John Fordham, Adelaide, Augusta, Walter Bruce.

(VI) John T. Dunn, eldest son of Isaac B. Dunn, was born in Elmira, New York, July 10, 1869. He attended the public schools, prepared at an institution of learning in Marietta, Ohio, entered Princeton University, whence he was graduated A. B. class of 1892. He prepared himself for the ministry, attending McCormick Theological Seminary one year, Gottingen University, Germany, one term, Princeton Theological Seminary two years and was there graduated Bachelor of Divinity, class of 1896. He was regularly ordained a minister of the Presbyterian church and for two years was engaged in preaching. His theological and philosophical study had led him into new lines of thought, and in following these he was receding from the orthodox creed of his church. Still, environment, family influence and personal friendships, as well as the sentimental appeal religion ever makes to the senses, held him to the ministry. But the new conception of truth drew with insistent strength, until finally swept from his moorings his integrity compelled him to abandon the ministry and with it the long cherished views, tenets, hopes and aspirations of a life time. By nature, talent, and preparation, Mr. Dunn was peculiarly adapted to the ministry and to renounce it cost him not only years of mental struggle, but many valued friends and engendered a disappointment that only time can alleviate. During these years of mental anguish, he was extremely careful in his pulpit utterances not to violate any of the orthodox tenets of his church, avoiding doubtful subjects in his sermons, strictly observing his ordination vows, and was faithful to his obligations until his decision was made and the ties sundered that bound him to the orthodox faith. He paid the price he must always pay who desires intellectual and religious freedom of thought, but with a conscience clear and with unsullied integrity, he has never regretted the decision arrived at and carried out with courageous fidelity to the dictates of his own conscience.

After passing this critical period of his life, Mr. Dunn began the study of law, under the preceptorship of his brother, Arthur; was admitted to the Lackawanna county bar in March, 1900, and at once became a member of the now eminent law firm, Dunn & Dunn. Both members of the firm have been admitted to all state and federal courts of the district. In their law practice they have been quite successful and as attorneys built up a very large mortgage business, having negotiated in Scranton and vicinity more than two million dollars of mortgage loans without the loss of a dollar of principal or interest. They became especially distinguished, however, as organizers and financiers,

1

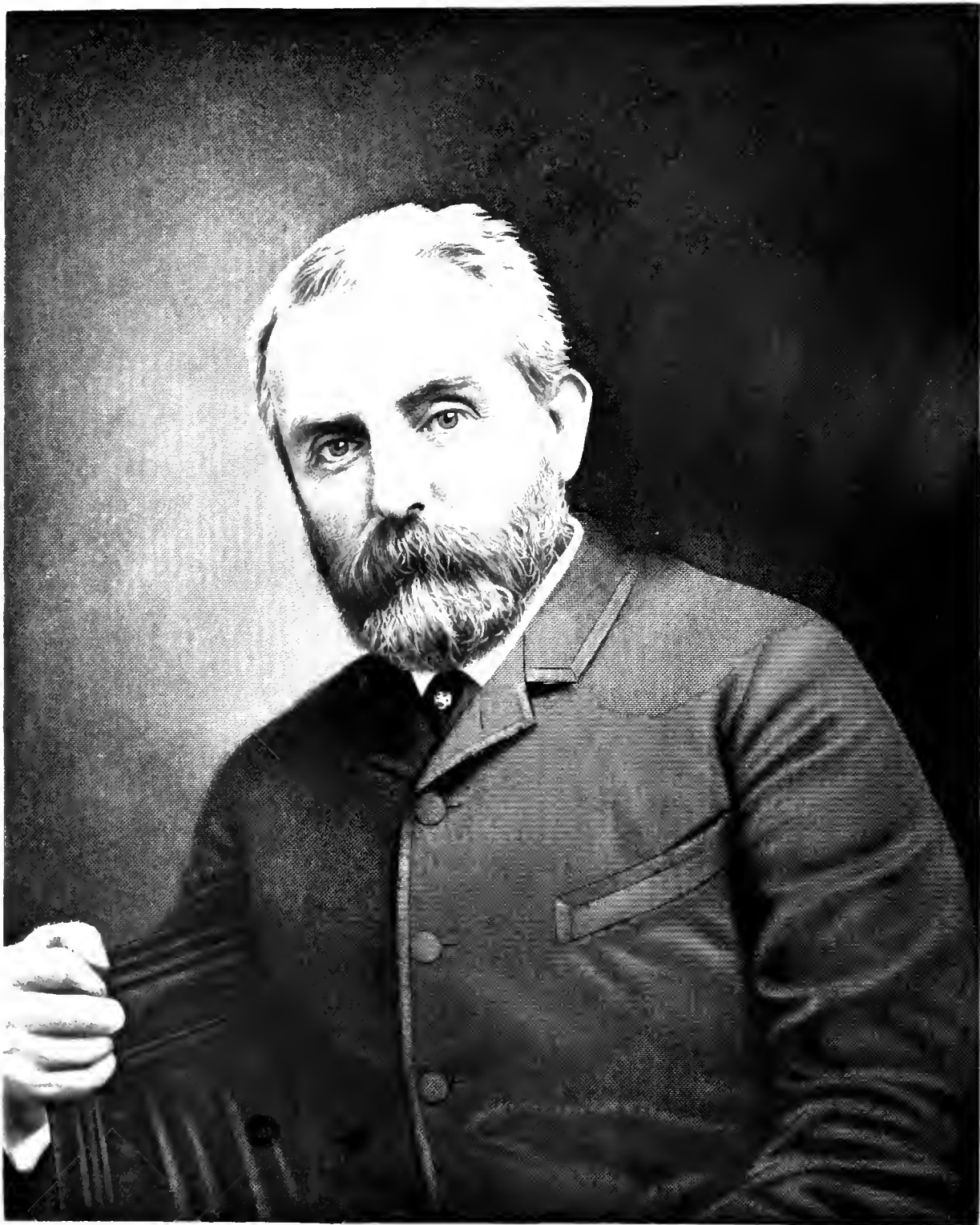

*Wm. Smith*



In this capacity they have added several monuments of prosperity to the city, such as the People's National Bank and the Anthracite Trust Company, which were directly organized by them; also the Providence Bank. Among other corporations organized by them were the Black Diamond Silk Company and the Scranton Real Estate Company, both being successful Scranton concerns. The Scranton Real Estate Company occupies its own handsome office building at 316 Washington avenue and is at the present time directly under their management and control, Arthur Dunn holding the position of president and John T. Dunn holding the official position of vice-president and treasurer. They have been organizers also of numerous other banks and corporations doing business outside of the city of Scranton. But Mr. Dunn likes best to be known as one interested in the public welfare. Comparatively few of the public undertakings for the betterment of his city find him absent, not so much in any prominent official capacity, but giving up much of his time and energy to personal work and often public speech.

John T. Dunn took an active part in the successful endeavor of his brother, Arthur Dunn, in reducing the Bi-Carmel council of Scranton, of sixty-two members, to one of five members. He has been very active and faithful in the effort made by the Scranton Surface Protective Association to protect the surface of Scranton. He is a member of the board of trade and always found present. While at Princeton Mr. Dunn was a member of Whig Hall, the famous university debating club. He was also a member of the University Glee Club. He is a member of the State and County Bar associations and of the Green Ridge Club. Until recently he was a member of the Scranton Club and the Country Club.

He married, December 19, 1906, Theodora Grace, daughter of Theodore F. and Matilda E. (States) Brown, of Wyalusing, Pennsylvania. Children: Theodore Brown and Henry Ernest. Mrs. Dunn is a member of the Elm Park Methodist Episcopal Church, of which Mr. Dunn is an attendant and supporter.

---

#### WILLIAM TALLMAN SMITH

The late William Tallman Smith, of Scranton, Pennsylvania, was recognized as one in whose personality were happily combined adherence to the loftiest ideals of integrity and a geniality which endeared him to all who had the honor of his acquaintance. His versatility of talent won for him unique distinction. In the world of art, in the world of literature, in the world of business, in the world of charitable deeds he was equally at home, honored, respected and admired by all. He was a descendant of English ancestors, whose first arrival in this country was in the year 1632.

Ruel and Judith N. (Haskell) Smith, parents of William T. Smith, were natives of Massachusetts, from which state they migrated to Vermont, settling in Middlebury where the father was in business as a merchant, removing from there to Rhode Island, in 1840, where they spent the remainder of their days, his death occurring in the year 1860, and her death in the year 1865.

William T. Smith was born in Middlebury, Vermont, November 30, 1834, and died suddenly in Florida, whither he had gone on a pleasure trip, March 25, 1898. When he was six years of age his parents removed to Woonsocket, Rhode Island, and the private and common schools of that town furnished him with the advantages of a good, practical education. Upon the completion of his studies he became clerk in a general store conducted by his brother at Woonsocket. He removed to Providence, Rhode Island, in 1857, and there engaged in business for a period of three years, after which he took charge

of the quarries of the Harris Lime Rock Company in Rhode Island. He secured a temporary release from these duties in the spring of 1862 in order to offer his services to his country during the Civil War. He enlisted in the Ninth Regiment Rhode Island Volunteer Infantry, for a three months' term of service, and was actively engaged in the defence of Washington, which was at that time threatened by the Confederate army. After his term of service expired and his recovery from a severe illness, he returned to his duties at the quarries, and his fidelity in the discharge of the same was recognized by election to the legislature, where he ably served one term. Immediately after the expiration of his term in the legislature, in 1865, he went to Texas with the intention of making his home there if the country was to his liking, but apparently he was not satisfied, as he returned at the end of a few months. Not long afterward he was appointed secretary and treasurer of two silver mining companies in Nevada, and in order to properly discharge the duties of these responsible offices he spent three years in that state. Business matters then kept him in St. Louis, Missouri, for one year.

In 1870 Mr. Smith became identified with the interests of Scranton. He then became superintendent of the Mount Pleasant Coal Company at Scranton, which was leased by a Boston company. He operated the mines of this company until 1877, then leased them in perpetuity for himself, and operated them during the remainder of his life, becoming one of the most extensive operators in the Lackawanna Valley.

A condensed account of his other business operations and interests is as follows: President of the Meredith Run Coal Company, and largely interested in the Sterrick Creek Coal Company; connected with the Scranton Forging Company, the Lackawanna Lumber Company, the Scranton Packing Company, the Lackawanna Mills, and some smaller corporations; became a stockholder in the Third National Bank at the time of its foundation in 1872, was elected a director in 1883, and was in office at the time of his death; was one of the incorporators of the Lackawanna Trust and Safe Deposit Company in May, 1887, was its first president, and was in office at the time of his death. He served as president of the board of trade, was elected president of the Scranton board of health in 1886, and while in office instituted many much needed reforms in this field.

This varied scope of activity did not prevent him from being equally active in other directions, notably those connected with charitable and religious matters. For many years he was a director in the Lackawanna Hospital, and so liberal was his support of this institution and so beneficial his efforts in its behalf that upon his death the authorities issued a memorial volume in recognition of his services. The Hahnemann Hospital also had the benefit of his support, as did the Home for the Friendless. He served as treasurer of the Associated Charities of Scranton for many years, and was one of the founders of the Oral School for the Deaf, an institution which has been of inestimable value. So generous, self-sacrificing and valuable had been his work in connection with this institution, that after his death the board of directors pronounced him as "necessary to the success of the work." The Scranton Public Library was another public institution in which he was greatly interested, serving as vice-president from the time of the organization of its board of trustees until his death. He donated the fine portrait of the founder of the library, Mr. Albright, for whom he had entertained a great admiration.

His religious affiliation was with St. Luke's Protestant Episcopal Church, in which he had been a vestryman for many years. The rector and other officials of the church said of him: "His purse, his time, his labor, the best gifts of his head and heart, have always been freely given for the upbuilding of

the church and the spreading of Christ's kingdom among men. He was a helper to every good work. Such a record is indeed rare, and must, we hope and believe, be a constant incentive to all who knew and loved him, to earnest efforts to continue the work which he so faithfully and usefully carried on." Art and literature found in him an ardent and generous patron, and it was a delight to converse with him upon these subjects and gain an insight into his rich store of information. Politically he gave his support to the Republican party, but was never desirous of holding public office. Many were the expressions of sympathy and the tributes paid to his memory by private people and the business corporations with which Mr. Smith had been associated. The limits of this article will not permit individual mention of all, but what was voiced in part by the Scranton Club expresses the feeling of all: "To speak of our loss is but to echo what has been felt by so many organizations with purposes widely divergent. Memories of his genial presence recall a personality rich in the qualities which make for personal friendship, the flower of all intercourse between man and man; and the Scranton Club will ever guard those memories, not only as golden links to the receding years, but also as an inspiration toward the maintenance of the highest ideals of companionship."

Regarded as a citizen, he belonged to that public-spirited, useful and helpful type of man whose ambitions and desires are centered and directed in those channels through which flow the greatest and most permanent good to the greatest number. He was well known to be a man of keen business instincts, a thorough manager and financier, and as most of his business affairs were of a public nature, bringing upon him the test of pure criticism, the high regard in which he was uniformly held was an indication of his strict fidelity to duty, his unswerving integrity and his honorable purpose. Feeling that he was blessed in business, he did not selfishly hoard his wealth, but used it largely and wisely for the good of the world, to relieve suffering and distress, to add to the beauty and joy of living and to the happiness of his fellowmen. He was a manly man, actuated in all he did by the highest principles and a broad humanitarian spirit, and his memory is hallowed by the love and regard which he engendered in the hearts of all who knew him.

Mr. Smith married (first) in Woonsocket, Rhode Island, in 1857, Annie E., daughter of George W. C. Jenckes, of that city. They had two children who died young. Mrs. Smith died in 1861. Mr. Smith married (second) in 1871, Abby H., daughter of Lorenzo Richmond, of Woodstock, Vermont.

Mr. and Mrs. Smith were in complete harmony in all their tastes, living an ideal life, she proving a helpmate in the truest sense of the word. She is a woman of the utmost culture and refinement, active and prominent in every worthy cause, giving freely of her time and substance to those less fortunate in this world's goods, and thus has won and retains the confidence and love of all with whom she is brought in contact, both in private and public life. Her gifts to the city of Scranton of the children's ward at the State Hospital in 1901 and the William Tallman Smith Manual Training School in 1905 were the carrying out of the known wishes and intentions of her husband. They are valuable additions to the charitable and educational work of the city, and will serve as monuments to the memory of Mr. and Mrs. Smith, more lasting and enduring than any other, by reason of the amount of good performed in each, and will serve to perpetuate their name in the city of Scranton as long as they continue to exist, their good continuing even longer. Men and women of the type of Mr. and Mrs. Smith are a blessing to a community, and their example should act as an incentive to others.

## GEORGE LINEN DICKSON

Crowned with the snow of eighty-three winters, but with eyes bright with the glow of his kindly spirit and brilliant mind, with step elastic, walks George Linen Dickson, the oldest banker of the Lackawanna Valley, dearly beloved, highly respected and a striking figure among Scranton's prominent citizens.

All but six of these eighty-three years have been spent in Pennsylvania, and fifty-three of them in Scranton. He is well known in the railroad world of the United States and Canada, as a manufacturer of railroad supplies and equipment, while his long connection with the First National Bank which dates from its organization, and as its vice-president since 1887, has made him equally well known in the financial world. As manager of the Dickson Manufacturing Company, he made his first entrance into Scranton business life in 1860, and from that time until the present there has never been a day that he has not been a vital factor in the life of Scranton, and now at the age of eighty-three years, so remarkable has been his life, and so conspicuous his work in the development and progress of the city, that no tribute is too lofty, too heart-felt, too generous for his friends to offer, nor is any mark of their respect and devotion withheld.

George Linen Dickson was born in Lauder, Berwickshire, Scotland, August 3, 1830, son of James and Elizabeth Linen Dickson. James Dickson was born in Scotland, son of Sergeant Thomas Dickson, a soldier of England. Sergeant Dickson served in the English army twenty-five years, participated in fifty-two engagements, fought with his regiment, the Ninety-second Highlanders at Waterloo, repulsing the last French charge, having previously been engaged with Wellington in the Peninsular campaign against Napoleon's marshals in Spain. He was with the army at the death of Sir John Moore, killed January 16, 1809, and was present at the funeral of that gallant officer, immortalized by the English poet, Charles Wolfe, in the poem entitled "The Burial of Sir John Moore."

James Dickson, son of Sergeant Thomas Dickson, was born in Scotland, December 25, 1801, died in Scranton, Pennsylvania, in his seventy-ninth year. He learned the machinist's trade in his native land, and worked there as a journeyman until 1832, when he came to America, landing at Quebec, Canada, after a voyage of seventy-seven days from Glasgow in the sailing vessel Chieftan. He located in Toronto, province of Ontario, spending two years there in charge of the machinery of a line of steamboats on Lake Ontario. Cholera there became epidemic and after he lost two of his children by that dread disease he came to the United States, reaching Rochester by boat, then to Rondout, New York, by Erie canal, thence by Delaware and Hudson canal to Honesdale, Pennsylvania, thence to Carbondale, to Dundaf, finally reaching the farm owned by his brother-in-law, George Linen. He soon left that point, returning on foot to New York, where he worked two years at his trade. He then returned to the Lackawanna Valley for his family, intending to take them back to New York with him, but on reaching Carbondale, Scotch friends there residing persuaded him to remain there in charge of the machine shops of the Delaware and Hudson Canal Company as master mechanic. He remained in that position eighteen years, when he was retired on a pension in acknowledgment of his valuable services. He then in association with his sons, Thomas, John and George L., organized the firm, Dickson & Company, Joseph Benjamin also having an interest. After two successful years the firm incorporated, in 1861, as the Dickson Manufacturing Company, with works in Wilkes-Barre and Scranton, doing locomotive and general machine work in the two plants. The burden fell upon the sons, the father having practically retired, but giving

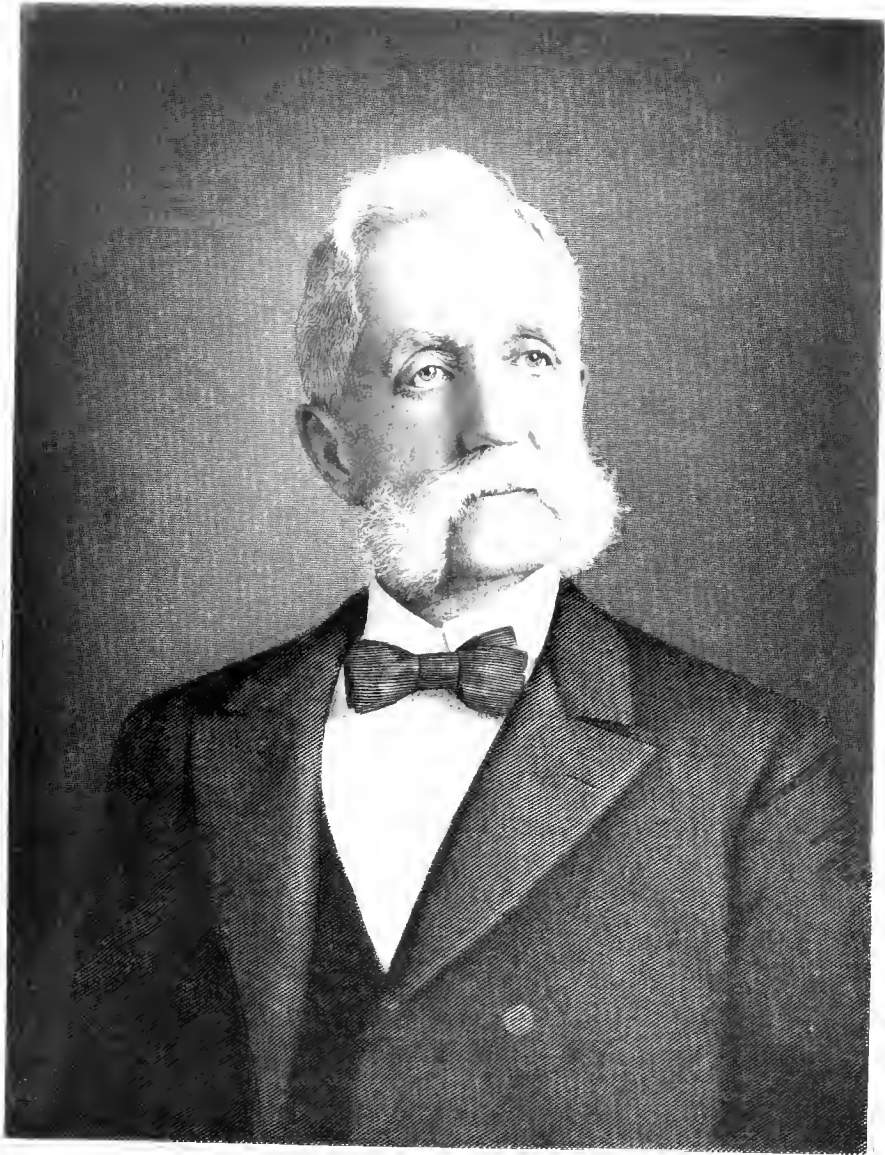

*G. L. Dickson*



to the younger men the benefit of his experienced judgment. James Dickson became a naturalized citizen of the United States, April 30, 1844, and cast his first vote for his favorite and greatly admired Henry Clay.

He married Elizabeth Linen, who like himself was born in Scotland, died 1866; both were communicants of the Presbyterian church, of which he was a deacon for many years. Five of their seven children, all born in Scotland, grew to maturity, the only present survivor being George L. Dickson of Scranton. Children: 1. Thomas H., mine superintendent of the Delaware and Hudson Canal Company, 1859-1864; then became general superintendent until 1868, when he was elected president of the company. He died at his summer home in Morristown, New Jersey. 2. Isabella, married John R. Fordham. 3. Mary, married (first) Andrew Watt, (second) J. B. Von Bergen. 4. John Alexander, died in 1867, being at that time general manager of the Dickson Manufacturing Company. 5. George Linen, of whom further. 6. and 7. Two other children, James and Elizabeth, both died in Canada, while young.

George Linen Dickson was about two years of age when his parents came to Canada and two years later was brought with them to the United States. He was educated in the public schools in Carbondale. He was intended by his pious parents for a minister of the Presbyterian church, but his brother, Thomas, having established in a mercantile business in Carbondale in 1845, prevailed upon his parents to allow George L. to enter his employ as clerk. He had as a partner Joseph Benjamin, who also was anxious to have the boy with them, so the parents consented, and on February 6, 1845, he began work, intending his stay to be brief, but he continued with his brother until he attained his majority and never returned to school. In 1851 he bought Mr. Benjamin's interest, the firm becoming G. L. Dickson & Company, his brothers, Thomas and John, being the other partners. The firm also owned Benjamin's old foundry, Thomas having charge of that, and George L. operating the store. In 1856 they sold the store, and as the Dickson Company, George L. operated the foundry at Carbondale, Thomas building and managing the Scranton plant. The company had incorporated as the Dickson Manufacturing Company, and on January 16, 1860, George L. Dickson came to Scranton as manager of the local plant, then beginning his twenty-two years' service with the company in Scranton. In 1867 he became president of the company, continuing until 1882, when he sold his interests and retired from the company. He then established a private business in railroad supplies and equipment, representing several of the best known manufactures of machinery and supplies in New York and Scranton, becoming widely known in the trade in the United States and Canada. He employed in his works and business during his manufacturing career, a large number of men, and made many friends among them, and also was universally popular with the trade. He was known as an upright, capable business man, wherever known at all, a reputation established by honorable straight forward dealing in every transaction, be it large or small. In 1863 he had aided in the organization of the First National Bank of Scranton, and until 1887 served as a director. He also was one of the organizers of the Scranton Steel Company, and was a promoter of other Scranton industries. In 1887, he was elected vice-president of the First National Bank and began withdrawing from his other enterprises, retaining only his official position with the bank since that date. He has maintained his high record as a business man and no less the able financier than the capable manufacturer. Much as he has accomplished in his worthy business career, it is the man himself that most attracts. He is sympathetic, kind and loyal, a firm friend and a good citizen.

Mr. Dickson has a distinguished Masonic career, being one of the oldest Masons in the city, and holding a secure place in the hearts of his brethren. He

was made a Mason in Carbondale, and there became worshipful master of his lodge. On coming to Scranton he demitted and joined Peter Williamson Lodge, Free and Accepted Masons. He is also past high priest of Lackawanna Chapter, Royal Arch Masons and past eminent commander of Coeur De Lion Commandery, Knights Templar. He is a thirty-second degree Mason of the Scottish Rite, belonging to the various bodies of that rite in Scranton. He joined the Independent Order of Odd Fellows in Carbondale and is a past noble grand. In religious faith he is an Episcopalian, having served as vestryman since 1859.

Mr. Dickson married, September 16, 1856, Lydia M., daughter of John M. Poore, of Carbondale. The only living child of this marriage is Walter May, of Scranton. He married Amanda Manville and has a son, George N., now a student at Cornell University, class of 1918. Lydia M. Poore was born in Palmyra, Wayne county, New York, a cousin of Ben Perley Poore, one of the most lovable authors and humorists of a generation past and gone. The Poore family is of English origin and was numbered among the early colonists of New England, where land purchased from the Indians is yet owned by descendants. Mrs. Dickson's paternal grandfather, Dr. Daniel Noyes Poore, was a native of Massachusetts, a graduate of Harvard College, and a skillful, well-known physician. Her father, Honorable John M. Poore, was born in Essex, Massachusetts; he aided in the construction of the Erie canal through Chenango county as a contractor on that section, in company with his father-in-law. Later he farmed for several years in the south and in 1846 located at Carbondale, Pennsylvania, of which city he was at one time mayor. He was a merchant in Carbondale but spent his latter years in Scranton, dying at the home of his daughter, Mrs. George Linen Dickson, aged eighty years. Harriet Townsend Poore, mother of Mrs. Dickson, was born near the Hudson river in New York, daughter of E. M. Townsend, a soldier of the War of 1812 and a pioneer settler of Carbondale, Pennsylvania, where he kept an inn in an old log house, long ago vanished. He was at one time sergeant-at-arms of the United States senate and was well acquainted with Henry Clay and other famous statesmen of that period. He died in Baltimore, Maryland, aged fifty-six years. He was a son of the Rev. Jesse Townsend, D. D., a graduate of Yale and a noted divine of the Presbyterian church. A brother of Mrs. Dickson, Townsend Poore, of Scranton, was long and prominently connected with the Delaware and Hudson Railroad Company. A distinguished member of the Townsend family was Martin L. Townsend, member of Congress from New York.

---

#### COLONEL FREDERICK LYMAN HITCHCOCK

Colonel Frederick Lyman Hitchcock, lawyer, soldier, and author of the present "History of Scranton," is a descendant of one of the old Puritan families who founded the New Haven colony. His ancestors were in Wallingford, Connecticut, as early as 1675, and in New Haven much earlier.

Peter Hitchcock, grandfather of Colonel Hitchcock, was a native of Claremont, New Hampshire, and his son, Daniel Hitchcock, was born in Wallingford. The mother of Frederick L. Hitchcock and wife of Daniel Hitchcock, was Mary Peck, daughter of Ward Peck, a soldier in the Revolutionary army, who served throughout the war. He was a nephew of him for whom he was named -- Major General Artemus Ward, the predecessor of General Washington in command of the Continental army. Ward Peck was but fourteen years of age when the war broke out; his brothers had all entered the army and he had tried to enlist, but had been rejected because he was under stature. He pro-



cured a large pair of boots and stuffed them with cloth in order to raise himself sufficiently to reach up to the measuring rod, and was accepted, notwithstanding his youth. He participated in nearly all the battles of the war, including Trenton, where he marched barefooted, his boots being worn out. The route of the American army, he said, could be traced by the blood from the feet of such as he. He was at Valley Forge and Brandywine, and was one of the four who bore the wounded Lafayette from the field. He was remembered by the latter, who on his visit to the United States showed him marked attention and expressed his gratitude.

Frederick Lyman Hitchcock was born in Waterbury, Connecticut, April 18, 1837, and was educated in the public schools there. When quite young he located in Scranton, Pennsylvania, and studied law with Samuel Sherrerd, of that city, and E. L. Dana, of Wilkes-Barre, and was admitted to the bar of Luzerne county, May 16, 1860. He practiced his profession until interrupted by the Civil War.

On August 22, 1862, he entered the army as adjutant of the One Hundred and Thirty-second Regiment Pennsylvania Volunteers. This regiment participated in the battles of South Mountain, Antietam and Fredericksburg in 1862, and Chancellorsville in 1863. At Fredericksburg he was twice wounded and left on the field for dead. Lieutenant Colonel Charles Albright, in his report of the battle, said: "The command was meager in officers; neither the colonel nor major were present, and just as the regiment was moving off to the bloody struggle, Adjutant F. L. Hitchcock, who had been absent on sick leave, came to my aid and assisted me greatly. He conducted himself with signal gallantry and bravery, and although wounded in two places continued on duty. His example on and off the battle field is worthy of imitation." Lieutenant Colonel V. M. Wilcox, commanding the One Hundred and Thirty-second Pennsylvania Regiment, said in his report of the battle of Antietam, September 17, 1862: "I cannot here too highly express my thanks and admiration for the assistance rendered me by Major Charles Albright and Adjutant F. L. Hitchcock. They never left the field for a moment, but by their coolness and bravery assisted me greatly in inspiring the men with that courage which it was necessary for men to possess under so severe a fire as that to which they were subjected." On January 24, 1863, Adjutant Hitchcock was promoted to major, and commanded the regiment at Chancellorsville. He was mustered out with the regiment, May 24, 1863. In December following he was examined by Major General Casey's examining board, and was awarded a commission as lieutenant-colonel of colored troops, and entered upon his duties at once, organizing the Twenty-fifth Regiment United States Colored Troops, at Philadelphia. Early in 1864 he was commissioned colonel, and served in the defenses at Fort Pickens and Pensacola, Florida, until December, 1865. During most of this time he served as inspector-general of the District of West Florida, in addition to his duties as colonel. His regiment was proficient in both infantry and artillery drill and practice. After a careful inspection and exhaustive examination by General Marey, inspector-general, United States Army, Colonel Hitchcock was offered the opportunity of remaining with the regiment as a part of the regular army of the United States, but declined.

His only brother, Edwin Sherman Hitchcock, enlisted in the Second Connecticut Volunteers in the first three months service, under Colonel Alfred H. Terry, in May, 1861; he was commissioned captain in the Seventh Connecticut Volunteers in the fall of the same year, under the same colonel, and was killed under circumstances of great gallantry at the battle of James Island, June 16, 1862.

Colonel Frederick L. Hitchcock was elected the first clerk of the mayor's court of the city of Scranton, in 1866, and in 1878 was appointed the first prothonotary of Lackawanna county; was secretary of the Scranton Board of Trade in 1869-71-72-73, and was president during the years 1909-10, and had the honor to represent the board in the National Board of Trade which meets annually in Washington, D. C., for nearly twenty consecutive years, and during this time was a member of its executive council. He has recently been honored with a life membership.

In 1866 Colonel Hitchcock entered into partnership with W. C. Dickinson, under the firm name of Dickinson & Hitchcock, in the crockery, china and glassware business, on Lackawanna avenue. The next year he bought Mr. Dickinson's interest and continued alone until 1868, when Ezra H. Ripple came into the firm, with William Connell as a silent partner, forming the firm of F. L. Hitchcock & Company. Colonel Ripple and Mr. Connell retired in 1872, and Henry A. Coursen came in, making the firm Hitchcock & Coursen. In 1875 Colonel Hitchcock retired and resumed the practice of the law. In 1877, during the riot period of July and August, he was appointed a member of the citizens' advisory committee of the mayor, and was one of a group of veterans of the Civil War who organized a citizens' corps for the maintenance of law and order, thirty-eight of whom met and dispersed the mob in the great riot of August 1, Colonel Hitchcock being second in command of the body of defenders that day. In 1878 he spent the winter in Harrisburg, working for the passage of the law creating Lackawanna county, and contributed in no small degree to its success. He was made secretary of the commission appointed under that law to survey, lay out and erect the new county. In 1879 he entered into partnership with J. Atkins Robertson in the real estate business, under the firm name of Robertson & Hitchcock. In 1882 this firm became the agents of the Barber Asphalt Paving Company, and secured the laying of the first modern street pavements in the city of Scranton. During the next five years the firm paved more than five miles of the city streets with asphalt pavements.

In 1877 Colonel Hitchcock's military knowledge and experience were called into action again, to assist in organizing the Scranton City Guard—four companies of the finest young men of the city. Colonel Hitchcock refused any office, but on request of Major H. M. Boies, and solely to help perfect the new organization, he accepted the appointment of adjutant. The following year, on the formation of the Thirteenth Regiment, National Guard of Pennsylvania, Colonel Hitchcock accepted, for the same reason, the lieutenant-colonelcy. The experience of 1877 had demonstrated the necessity of a first class regiment at this point, and he freely gave his time and military experience towards the perfecting of the regiment. In 1883 Colonel Boies declining a re-election, Colonel Hitchcock accepted its leadership and served until 1888. During the second year of his term as colonel, and each year thereafter he succeeded in qualifying every man in the regiment as marksman in rifle practice—the first regiment to reach that standard in the history of the National Guard. Declining a second term, he was presented by his fellow officers with a souvenir on which was inscribed the following legend: "He led the regiment from the left to the right of the line, and stood with it at the head of the National Guard of Pennsylvania."

Colonel Hitchcock was director of public safety for six weeks during the administration of Mayor James Moir, during which he reorganized the city fire department, placing it on a practically paid basis. He also compelled all liquor dealers to obey the law. All drinking places were closed at 12 o'clock p. m., and on Saturdays compelled to remain closed until 6 o'clock a. m. Mon-

day. His activities in this respect made him *persona non grata* to the liquor interests, and he was removed. On the incoming of the administration of Mayor J. Benjamin Dimmick, in 1906, Colonel Hitchcock was appointed city treasurer, which office he held for three years, until the close of that mayoralty term. During this period he inaugurated the system of depositing the city funds in the several banks of the city drawing interest on monthly balances.

Colonel Hitchcock was one of the three ruling elders elected and ordained at the organization of the Second Presbyterian Church of Scranton, in 1874. During his eldership he represented the Presbytery of Lackawanna as a lay delegate in the general assembly of the Presbyterian Church of the United States, which met in Cleveland, Ohio, in 1875. He was again a delegate to the general assembly of 1808, and was a member of its judicial committee which had before it the question of the trial of Professor McGiffert, of New York, for heresy. It was Colonel Hitchcock's resolution that disposed of the case by asking Professor McGiffert to resign from the Presbyterian church on account of incompatible views. Colonel Hitchcock was superintendent of the Sunday school of the Second Church for several years, continuing in that office until his removal to Green Ridge, a suburb of Scranton, in 1881, when he severed his membership with the Second Church and united with the Green Ridge Presbyterian Church. He was superintendent of a flourishing mission Sunday school for four years prior to his connection with the Second Church. In 1883 he was elected superintendent of the Green Ridge Presbyterian Sunday school, and served as such for eight years, and in 1888 he was elected an elder in the church, and is still serving in that office. He was president of the Young Men's Christian Association of Scranton in 1875-76-77, and has also served as treasurer. He is president of the Security Building and Loan Association, and treasurer of the Barium Produce Company. He has been prominent in the Masonic fraternity, being one of the oldest past masters of Union Lodge, No. 291, F. and A. M., and he is also a director of the Pennsylvania Oral School for the Deaf.

Colonel Hitchcock married, January 24, 1865, Caroline Neal Kingsbury. Her great-grandfather was Deacon Ebenezer Kingsbury, of Coventry, Connecticut. He was a member of the Connecticut general assembly thirty-eight years, a military officer of rank, and a man of note in the community. Her grandfather, Rev. Ebenezer Kingsbury, was a native of Coventry, Connecticut; graduated from Yale College in 1783 and studied theology with Dr. Backus, of Somers, Connecticut, and was pastor of the Congregational Church at Jericho Centre, Vermont, when he visited Harford, Susquehanna county, Pennsylvania, and received a call to settle, February 21, 1810. He was installed in August following, and continued his pastoral labors there for seventeen years. He traveled over a large part of the counties of Susquehanna, Bradford and Wayne on horseback, finding his way by marked trees and bridle paths, preaching in log cabins, barns and school houses, of which latter there were a very few at the time, and assisted at the formation of nearly all the churches in that region. He died at Harford in 1842. The wife of Rev. Ebenezer Kingsbury was Hannah Williston, a daughter of Rev. Noah Williston, who was born in 1733, graduated from Yale College in 1757, ordained in West Haven, Connecticut, in 1760, and was for fifty-two years pastor of the West Haven Congregational Church, and died there, aged eighty years. His wife was Hannah Payson, of Pomfret, Connecticut. The eldest son of Rev. Noah Williston was Rev. Payson Williston, who was for forty years pastor of the Congregational Church at Easthampton, Massachusetts. Hon. Samuel Williston was founder of Williston Seminary, at Easthampton, to which he gave \$250,000. He was also a son of Rev. Noah Williston. The father of Mrs. Frederick L. Hitchcock

was also named Ebenezer Kingsbury. He was born in Vermont, June 13, 1804. At six years of age he came with his parents to Harford, Pennsylvania. He studied law with William Jessup, at Montrose, and was admitted to the bar, September 2, 1828. In 1830 he was appointed deputy attorney general for Susquehanna county. He removed to Honesdale, Pennsylvania, in 1833, where he resided until his death, in 1844. From 1833 to 1840 he was editor and proprietor of the Wayne county *Herald*. From 1837 to 1840 he represented Luzerne, Monroe, Pike and Wayne counties in the state senate, and in the latter year he was speaker of the senate. He married, in 1820, Elizabeth Harlow Fuller, a daughter of Edward Fuller, born in Plymouth, Massachusetts. He was a descendant of Dr. Samuel Fuller, "the beloved physician," who came over in the "Mayflower." His wife was Hannah West, a native of Norwich, Connecticut. They had six children, of which Mrs. Hitchcock, the youngest, and Edward Payson Kingsbury, late controller of the city of Scranton, and present auditor of the Enterprise Powder Company, only survive. Mr. and Mrs. Hitchcock have had a family of seven children: Edwin Sherman, Frederick Kingsbury, Henry Payson, all now deceased; Lizzie Fuller, married George B. Dimmick; John Partridge; Mary Peck, married Robert S. Douglas, of Newark, New Jersey; Carrie Guilford Hitchcock.

---

#### WILLIAM W. SCRANTON

The Scrantons, of Scranton, Pennsylvania, are descended from John Scranton, who with others, in all about twenty-five heads of families, came to America, landing at Boston in 1637, and founded the plantation of Guilford, Connecticut, in 1639, being one of the three plantations constituting the colony of New Haven, later the colony and State of Connecticut. They came from England, from the town of Guilford, and the counties of Kent and Surrey, descended from a people who had their rise in the reign of "bloody Queen Mary," under whose persecuting reign their meetings for religious worship without a liturgy were broken up and some of them burned at the stake.

(I) Seeking religious liberty, these early Puritans came to America, and among them was John Scranton. He was then under thirty years of age, and lived until August 27, 1671, and died at the age of about sixty. He was a free burgess, and was one of the company which in Robert Newman's barn in New Haven on June 4, 1639, laid the foundation of civil and religious polity by the adoption of an order of liberal government for what ultimately became the State of Connecticut. He was a man of prominence in the colony, was marshal of the colony, was repeatedly on committees of executive importance; was a member of the general court in 1660 and 1670. The inventory of his estate is recorded in the New Haven Probate Record, October 27, 1671.

(II) Captain John Scranton Jr., eldest child of the emigrant, John Scranton, and the first of the family name born in America, settled in East Guilford, which thereafter became the family home, and died September 2, 1703, age sixty-two. He was known as Captain John Scranton, was nominated in 1660 to be made a burgess, and at the next general court was privileged to take the freeman's oath. He commanded the military forces of the settlement, a position of great importance, subject as they were at that period to attack by the savages, as well as by the Dutch in New York. He was a successful planter and died in 1703, aged sixty-two, leaving what was then a large estate to his children.

(III) Captain John Scranton, eldest son of the preceding, born in 1676, died March 31, 1758. He lived in East Guilford, and, like his father, commanded the military of the town; was a man of considerable property, and



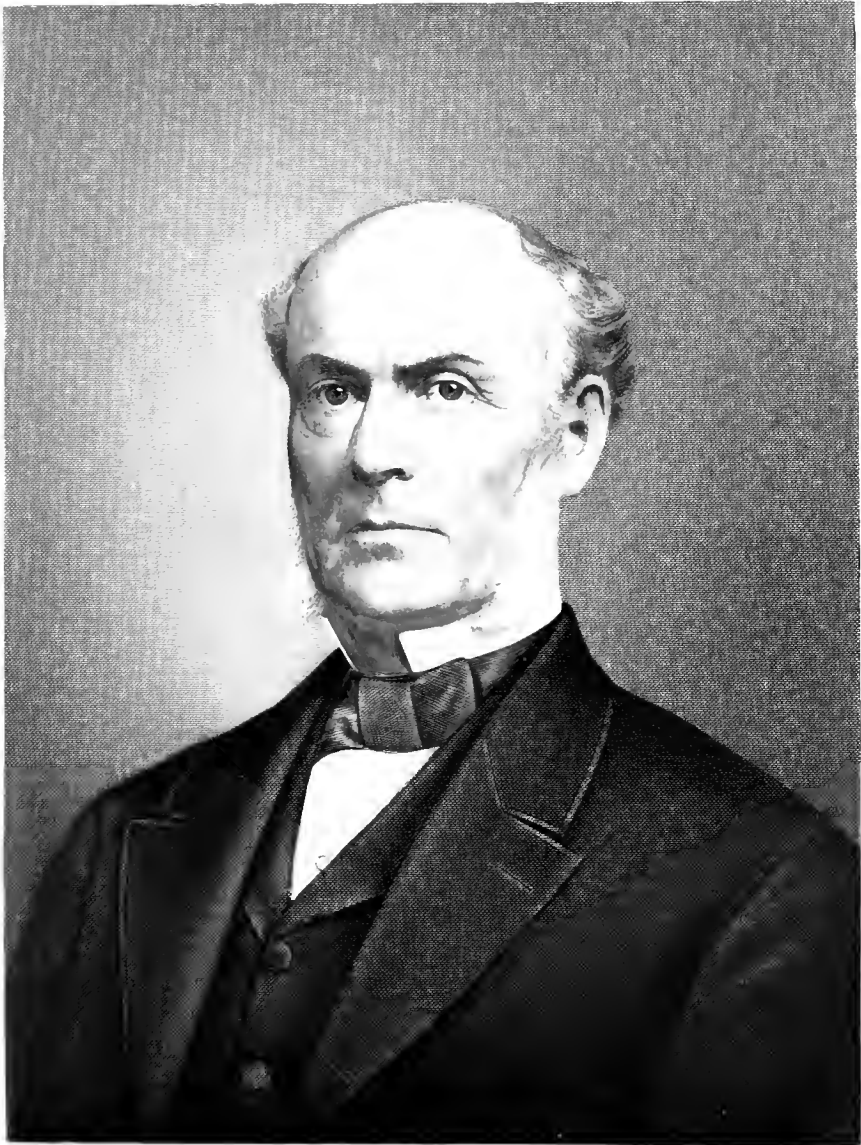

*S. S. S. S.*

in his will made ample provision for the support of his negro man and his Indian slave, allowing them to choose with which of his children they should live.

(IV) Captain Ichabod Scranton, son of the preceding, born February 10, 1717, lived in East Guilford, Connecticut. A natural soldier, like his ancestors, he took part in both the old French wars of 1745 and 1755, fought at the siege and capture of Louisburg under Sir William Pepperell, and served in the campaigns around Lake George and Lake Champlain against Fort William Henry, Ticonderoga and Crown Point. On returning from Ticonderoga after the conquest of Canada, he was seized with small-pox at Albany, New York, and died November 1, 1760, aged forty-three. He was a man of patriotism, enterprise and great personal courage, and his death was mourned as a public calamity.

(V) Theophilus Scranton, born December 1, 1751, died February 16, 1827, eldest son of Captain Ichabod Scranton, lived and died in East Guilford, now called Madison. Only twenty-four at the outbreak of the Revolution, he was forced to remain at home as the sole support of his mother and sisters, enabling his two younger brothers to enter the Continental army, one becoming an officer in the cavalry and the other in the infantry.

(VI) Jonathan Scranton, born October 10, 1781, son of the preceding, was well known as a contractor of wharves, break-waters, light houses and other public works. He was a leading member of the church in Madison and prominent in the affairs of the town. He died July 27, 1847. He was the father of Joseph H. Scranton, of Scranton, Pennsylvania, of whom notice will be found below; also of Erastus C. Scranton, of New Haven, president of the Second National Bank of New Haven, and at the time of his death president of the New York, New Haven & Hartford Railroad; also of Sereno H. Scranton, of Madison, Connecticut, president of the New Haven, New London Railroad, and later of the Mobile & New Orleans Railroad.

(VII) Joseph Hand Scranton, son of Jonathan, while not the first of his name in Scranton, was the first of his direct family to make that city his residence. He was born in East Guilford (Madison), Connecticut, June 28, 1813, located in Scranton in 1847, and died in Baden Baden, Germany, June 6, 1872. He began his business career in a New Haven store, but while still a young man moved south, locating in Augusta, Georgia, where he became head of one of the largest mercantile houses of that city. While in Augusta he made the first of his series of investments in the Lackawanna Valley of Pennsylvania. His cousins, George W. and Selden T. Scranton, with others, had begun the manufacture of iron on the banks of Roaring Brook, and, needing financial assistance, applied to their cousin, Joseph H. Scranton. He responded with a loan of \$10,000, later invested still more heavily, and in 1847 purchased the interest of one of the partners, Mr. Grant. In that year, after becoming an active partner in the business, he moved to Scranton and thereafter made that city his home. The firm successfully solved the problem of iron manufacture with anthracite coal as fuel, but labored under the great difficulty of distance from a market, without railroad facilities. But this problem was also solved by their efforts, and with the building of the Delaware, Lackawanna & Western Railroad, prosperity came. In 1853 members of the firm organized the Lackawanna Iron and Coal Company, with Joseph H. Scranton as manager until 1858. In that year he was elected president, and continued its honored efficient head until his death in 1872. In 1863, recognizing the need of better banking facilities, he with others organized the First National Bank of Scranton, was its first president and continued

at its head until his death. Prominent as he was in these two great Scranton institutions, they represent but a part of his business activities. He was the first president of the Scranton Gas and Water Company, continuing until his death; a director of the Delaware, Lackawanna & Western Railroad Company; of the Mount Hope Mineral Railroad Company; the Sussex Railroad of New Jersey; the Franklin Iron Company; the Scranton Trust Company and Savings Bank; the Dickson Manufacturing Company; the Moosic Powder Company; the Oxford Iron Company, and several western railroads, in which he had largely invested. His standing in railroad circles caused his appointment by Congress as one of the first commissioners of the Union Pacific Railroad, an honor he fully deserved.

Under the strain of his many responsibilities, Mr. Scranton's health finally gave way, and in January, 1872, with his wife and daughter, he journeyed abroad, hoping in complete rest and freedom from the exactions of business to regain his health, but in vain, his death occurring the following June while at Baden, Germany. His remains were returned to his adopted city, and there on July 13, 1872, he was laid at rest in Dunmore cemetery. He was awarded signal honors by the community he had so valiantly striven to up-build; business was suspended and the flags of the city waved at half-mast on the day of his funeral, and the press of the country printed fervent eulogies of the man whose usefulness was recognized far beyond local confines. Rev. Dr. Cattell, of Lafayette College, preached the memorial sermon before an immense congregation of sincere mourners. He said in the course of his sermon: "I know not of how many companies he was president or manager or director, or of what great public interests he was the guiding spirit; but I do know he was a Christian man, and for many years was the superintendent of the Sabbath school of his church (Presbyterian), and that he was a man whose success in all things that men most desire and for which they strive and toil, was conspicuous."

Perhaps the best expression of the public feeling entertained toward Mr. Scranton is found in the resolutions adopted by the directors of the First National Bank of Scranton:

Resolved; That having been associated with Mr. Scranton in the direction of the affairs of this institution from the date of its organization, we bear cheerful testimony to his great executive ability, untiring energy, perfect integrity and unselfish devotion to its interests and to his high-minded and gentlemanly bearing in all his official intercourse whereby he contributed largely to the success of the institution, while endearing himself to us by his amiable, generous disposition.

Joseph H. Scranton married (first) August 1, 1837, Eliza Maria Wilcox, of Madison, Connecticut. He married (second) July 3, 1843, Cornelia Walker, daughter of Judge William P. and Lucy (Adam) Walker, of Lenox, Massachusetts. He was survived by issue of both marriages.

(VIII) William Walker, eldest son of Joseph Hand Scranton and his second wife, Cornelia Walker, was born in Scranton, April 4, 1844, and is now the only one of his name and generation living in the city that owes so much to his family. He has ever resided in the city of his birth and has borne his full share of the burden of the development of the great iron and steel interests and public utilities of Scranton. He began his education in the public schools, passing through the high school, then entering Phillip's Academy at Andover, Massachusetts, where he finished his college preparation. He then entered Yale University, whence he was graduated, class of 1865. While at Yale he took deep interest in athletics, and in 1864 and 1865 was bow oar on the famous Willbur Bacon crew, which won from Harvard in those years. His fraternities were Kappa Sigma Epsilon, Alpha Sigma, Delta Kappa Ep-



silon; his society, the famous Scroll and Keys. It is interesting to record that after leaving college, Mr. Scranton did not forsake his athletic training, but continued so effectively that at the age of thirty-six years, in the presence of witnesses, he lifted a dead weight of two thousand pounds.

Finishing his college career in 1865, Mr. Scranton at once began his long and successful business career, in Scranton. After thoroughly mastering its details by serving two years at the works of the Lackawanna Iron and Coal Company, of which his father was president, he was appointed in 1867 superintendent of the company's new mill, and in 1871 was appointed assistant to the president and superintendent of all the company mills. In 1874 he journeyed to Europe, making a special study of Bessemer steel manufacture as practiced in English, French and German plants. On his return in the autumn he was made general manager of the Lackawanna, Iron and Coal Company, and at once began the utilization of his recently acquired knowledge by erecting a Bessemer steel rail mill and works, doubling the capacity of the works and improving its quality. The increased demands of the steel works, also resulted in quadrupling the output of the company's mines and collieries. During his connection with the company he was obliged to act defensively in the protection of the company's interests during labor troubles, and in 1871 led to and from the mines daily a party of non-striking miners; he leading an escort of a body of miners from the mines homeward, was attacked by a mob, and in self defense two of the rioters were killed. During the railroad riots of 1877, when the works of the Lackawanna, Iron and Coal Company and the shops of the Delaware, Lackawanna & Western Railroad Company were attacked by three thousand rioters, with an armed party he met the mob, who were dispersed in a few minutes, but not before three of their leaders were killed. The leaders of the striking element caused the arrest and trial of Mr. Scranton and his party on the charge of manslaughter, but they were acquitted, with the thanks of the court for their action in quelling the riot.

In 1880, Mr. Scranton resigned his position as manager of the Delaware Iron and Coal Company, having decided to embark in the steel business independently. He began by again studying the conditions existing in the steel mills of Europe, and from the conclusions reached formed his plans. On his return to the United States he organized the Scranton Steel Company, with works at Scranton, and there rolled the first one hundred and twenty foot rails from the steel ingot, afterwards, cutting them into thirty foot lengths. He continued president of the Scranton Steel Company until 1891, when that company was consolidated with the Lackawanna, Iron and Coal Company, Mr. Scranton withdrawing from all connection with the business save as investor. He then and since has devoted himself principally to the extension and management of the Scranton Gas and Water Company, founded by his father in 1854. This, with various subsidiary companies, supplies water and gas in Scranton, and water to all points north of city in the Lackawanna Valley to a distance of twenty-four miles. There are other important interests in Scranton that have benefited by the business ability and experience of Mr. Scranton and there has been little in the way of charitable, religious, educational or philanthropic development, but what has had his support. He is a strong level headed man of affairs, but the finer side of his nature responds to every appeal or demand made upon it. While never a politician or office seeker, he has taken deep interest in city affairs and aided the cause of good government in many ways. Now nearing his seventieth year, he is a man of unusual strength, bodily and mentally, showing few signs of the active scenes he has passed through, nor the many years of association with Scranton's great industries.

Mr. Scranton married, in Saint Albans, Vermont, October 15, 1874, Katharine M., daughter of Hon. Worthington C. Smith, Member of Congress from Vermont. The only child of this marriage is Worthington Scranton, of whom further.

(IX) Worthington Scranton, only son of William W. and Katherine M. (Smith) Scranton, was born in Scranton, Pennsylvania, August 29, 1876. His early education was obtained in Kalin's private school, preparing for college at Belmont School, (Massachusetts). He then entered Yale University, whence he was graduated, class of 1898. He then entered Harvard Law School, receiving his degree of LL. B., class of 1901. Returning to Scranton he actively engaged in business with the corporations in which his father was interested, principally confining himself to the development of the Scranton Gas and Water Company, of which he is vice-president. He is also a director of the County Savings Bank and has other and varied interests. He is a member of the Scranton and Country clubs of Scranton, the University and Yale clubs of New York, and the Engineers' Society of Northeastern Pennsylvania. His college fraternity is Psi Upsilon.

Worthington Scranton married, April 11, 1907, Marion Margery, daughter of Major Everett Warren, of Scranton (see sketch in this work). Children: Marion, Katherine, Sarah.

---

#### JOSEPH ANSLEY

Although thirteen years have elapsed since the death of Joseph Ansley, one of the old guard of Scranton's business men, who was identified with many of the infant, now mature, industries of the city, the memory of his uncommonly useful life still remains fresh in the minds of those whose privilege and pleasure it was to know him. The beauty of his life and the sweetness of his character, together with the breadth of human sympathy that characterized his every action, gained for him a place in the hearts of his friends and acquaintances that was ever held sacred, even after the summons of the last call had taken him from their midst into the glories of the reward promised to those whose lives and thoughts are pure and undefiled. He was spared many of the soul scars that come from faithless and designing friends, departing this life with a firm belief in all of God's creatures, born of a perfect love of their Creator. Joseph Ansley was probably of Scotch descent, the family having been planted in Pennsylvania by his grandfather, who came thither from Connecticut, locating at Paupac, Pike county.

Brinson Ansley, father of Joseph Ansley, lived there as a farmer, married Elizabeth, daughter of Leonard Le Barr, and became the father of four children: Leonard, Joseph, William, and Amelia.

Joseph Ansley, second son and child of Brinson and Elizabeth (Le Barr) Ansley, was born in Paupac, Pike county, Pennsylvania, October 26, 1825. He was there instructed in the public schools, early in life learning the trade of carpenter with a workman named La Farge. After completing his apprenticeship, he remained in the vicinity for several years, then moved to Hawley, where he began his successful career. Working for a time at this trade, he soon began widening his operations, buying land and conducting an extensive contracting business. In connection with this he also did a great deal of undertaking work in the neighborhood. The scope of his enterprises extended, he became a contracting builder, erecting many homes and business establishments in the town, many upon land purchased earlier, his holdings including the present site of the Hawley saw mills and other buildings. Among the buildings he erected were the First Baptist and Catholic churches and the first

grist mill in Hawley. Besides his other interests he was the proprietor of a lumber mill and a planing mill. So successful was he that in 1866 he located in Hyde Park where he established the lumber business now owned by Washburn, Williams & Company. Soon after his coming to Hyde Park, Mr. Ansley formed a partnership with Nicholas Washburn and Samuel Heller. In 1868 he bought out the interest of Mr. Heller and three years later that of Mr. Washburn. It was during his partnership with Mr. Washburn that the planing mill and sash and blind factory were established, but soon after Mr. Ansley continued in the business alone, so that while the credit for the installation of that department must be shared between them, it was Mr. Ansley who raised these processes to the high degree of development they had attained at his death. Until early in 1879, a building, known as Hernian's shop was used for factory purposes, when substantial stone and wooden shops were completed and the business housed therein. Under Mr. Ansley's skillful management, the number of operatives increased until the payroll included 100 persons. It is a splendid tribute to his ability as an organizer that the business he founded so many years ago is not only still in existence, but conducting operations upon a larger and more lucrative scale than ever before. In 1906, the widow and heirs of Mr. Ansley incorporated the Ansley Lumber Manufacturing Company, which employs about fifty persons and supplies local trade.

While Mr. Ansley never allied himself with any religious denomination, he conscientiously recognized and observed the obligations he felt to be his, attending regularly the services of the Presbyterian church. In his political action he was actuated entirely by the merits of the candidates and the comparative strength of the party platforms. He cast his first vote for a Democratic candidate, in the next presidential campaign acting with the Whigs. The slavery discussion at this time led him to change his political affiliations, and at the organization of the Republican party, and the presentation of its first presidential candidate, John C. Fremont, he voted for him, ever afterward supporting that party.

Mr. Ansley married, September 9, 1850, at Wilsonville, Pennsylvania, Mary C., now deceased, a daughter of William and Elizabeth (Shouse) Mason. Children: 1. Elizabeth, deceased. 2. Matilda, deceased. 3. Sarah, married Henry T. Porter, deceased; children: Ethel, married Paul Johanning; Pearl, married Alvin W. Decker, of Scranton; Leila, married Walter S. Jones, of Buffalo, New York. 4. John, deceased. 5. Lincoln (twin), a lumber dealer of Colorado. 6. Hamlin, twin of Lincoln, died aged twenty-one years, born during the presidential campaign of 1860, they were named in honor of the Republican candidates for president and vice-president. 7. Joseph, a lumber dealer, married Margaret Shiffer; children: Sarah, deceased; Joseph and James. 8. James, deceased. 9. Edward, engaged in the lumber business; married Matilda Thompson, and had children: Ruth, deceased; Mary, Allen and Edward. 10. Frank, deceased. 11. Anna.

In closing a recital of the life of Joseph Ansley, it would be indeed an unfaithful portrayal if no mention were made of the close and sympathetic union existing between him and his wife. Congenial in every respect, one supplying the needs of the other, with an almost sacred affection between them, they were indeed happily mated. United in wedlock for better or worse, the passing years had brought them greater opportunities for the enjoyment of life, but the coming of riches could not strengthen their undying love, nor the luxury of wealth add one iota to the joy of their happiness.

Mr. Ansley's death, occurring March 23, 1891, was deeply mourned throughout the locality which had been the scene of his life and labors. Although in later years removed from active business dealings he was still a

familiar figure in the city. Of fine, erect bearing, his flowing white beard and kindly aspect lent to him a patriarchal dignity. His commanding appearance was a faithful indication of the beautiful spirit within, now long gone to its heavenly rest.

---

#### CAPTAIN W. A. MAY

Liberal education for the profession of civil engineer, but called by the evidence of his extraordinary ability in dealing with men and in conducting business affairs from his chosen calling, W. A. May to-day stands as one of the most notable figures in Scranton. The city is indebted to him for valiant services rendered the industrial interests of Scranton during the years marking the crucial period in the history of manufacturing in that place. His activity and interest in many of the most important commercial enterprises of the locality has made him a prominent man of affairs and placed him high in the ranks of the men who "do things" in Scranton.

Lewis May, father of Captain W. A. May, came to the United States from Germany, where he was born and in which country he received an exceptionally wide education, preparing him for the Evangelical ministry. He was only twenty years of age when he arrived and spent most of his life in Pennsylvania, holding several charges. He married Louisa Haines, of an old Philadelphia family, who lived on a farm where Frankford is now located. Lewis May was an inspired and faithful minister of the Gospel, preaching with all the ardor of heartfelt conviction and laboring earnestly in the service of his Master, and his work was blessed with gracious results.

Captain W. A. May, son of Lewis and Louisa (Haines) May, was born in Hollidaysburg, Blair county, Pennsylvania, December 3, 1850. He obtained much of his early education by attendance at the public schools in the various places to which his father's ministerial duties called the family. When he was but fourteen years of age his father's death occurred, his mother going to her heavenly rest three years later. All of his later education, remarkably comprehensive and thorough, was obtained through his own unaided efforts. He prepared for college at Dickinson Seminary, being awarded the degree of Bachelor of Arts. Although taking a seminary course, he was able to devote a great portion of his time to the study of civil and mining engineering, and, his natural aptitude for this work placing him far in advance of the ordinary college graduate, was offered a position as rod man on the force but within a year he became chief of the engineering department of the Hillside Coal and Iron Company. His reputation had preceded him in his position and the masterly manner in which he directed the engineering corps of the company, as well as his highly efficient personal work, gained him unusual distinction in his profession, although he was not yet twenty-three years of age. Feeling the need and realizing the benefits of a more advanced education, he severed his business connections and matriculated at Lafayette College in order to make more ample preparation for his life work. He was graduated from this institution C. E. in the class of 1876, afterward receiving the degree of Master of Arts from the same college. He then resumed his studies as chief engineer of the Hillside Coal and Iron Company, from which position he rose steadily until he reached a height which placed him among the most influential men in industrial operations of to-day. Two years after rejoining the Hillside Company, he added to his duties those of chief engineer for the North Western Mining and Exchange Company, in Elk county, Pennsylvania, and still later took charge of the engineering departments of the Meredith Run Coal Company and of the Gaines Coal and Coke

Company, in Tioga county. He satisfactorily discharged all of the obligations which these offices involved until 1883, when he accepted the superintendency of the Hillside Coal and Iron Company. He served as such until 1901, when he became general manager of the Pennsylvania Coal Company and the New York, Susquehanna & Western Coal Company. From 1898 to 1901 he had been superintendent of the latter company, and is now in charge of the combined interests, one of the largest in the Scranton coal region. To understand the vast size of the operations controlled by these three corporations and the stupendous burden daily borne by Captain May in adjusting and conducting their multifarious affairs, it is only necessary to state that they control 30,000 acres of coal land, with an annual output of 7,000,000 tons, handling, in addition, one and a half million tons purchased under contract. About 16,000 men are in the employ of these companies. He also became general manager of the North Western Mining & Exchange Company and the Blossburg Coal Company, January 1, 1908. These companies employ about 2000 men and produce one and three quarter million tons annually. He became president of these five companies, February 1, 1913, having been made vice-president and general manager, December, 1911.

Captain May also has been prominent in many of the movements that have been of the greatest benefit and uplift to Scranton, his role in connection with the city board of trade being most useful and important. From 1893 to 1897, inclusive, he was president of that organization. It was in the first year of his administration that the panic occurred, demoralizing all the trade conditions and leaving many of the city's industrial establishments in a state of half suspended activity. Through his brilliant efforts new capital was introduced, business roused from its languorous somnolence, and fresh vigor imparted to the mercantile and manufacturing life of the city. He also was instrumental in raising the board to its present state of active efficiency and it was under his direction that the plans for the magnificent new board building were made. He was vice-president of the Board of Trade Building Company, also serving upon the leading board committees. He is a director of the Third National Bank; trustee of Lafayette College since 1912 and of Williamstown Dickinson Seminary for the past twenty years. In pursuance of his constructive policy for Scranton, Captain May gave liberally of his time and services for the forwarding of the erection of three of the edifices housing organizations which exercised a strong influence upon the life and thought of the city, the Thirteenth Regiment Armory, the Young Men's Christian Association, and the Elm Park Methodist Church building.

Captain May enlisted as a private in the Thirteenth Regiment Pennsylvania National Guard, February, 1878, and was mustered out in November, 1888, as captain of Company D. He is the holder of a ten-year marksmanship medal which serves to keep fresh the memory of that period of service. That he still recognizes allegiance to the old regiment is shown by the interest he takes in and the support he gives its every enterprise. He belongs to the Elm Park Methodist Episcopal Church and is a member of its board of trustees. In the work of the Sunday school connected therewith he has ever been prominent and is now its superintendent. His exertions in behalf of the Young Men's Christian Association have been productive of a great deal of good, and as a member of the board of trustees he has largely helped to perfect the organization of that institution and to make it the power among the adolescent youth of Scranton that such an association should be. He is a Republican in politics, and belongs to the American Society of Civil Engineers, the Scranton Engineers' Club, the Scranton Club, the Westmoreland

Club of Wilkes-Barre, and the Machinery Club of the city of New York. His fraternal affiliation is with the Masonic Order.

Captain May married Emma Louise, daughter of B. L. Richards, of Williamsport, Pennsylvania. Of this marriage has been born a daughter, Maud Richards, now Mrs. James Whittaker Page.

The life of Captain May has been one of exceptional attainment and service. Playing a man's part in the stern game of life he has emerged from the struggle strengthened and bettered by the test of skill and endurance, and in the gentler paths of men he has ever been a vital force for good, a help and an inspiration to his friends and acquaintances.

---

### JOHN H. BROOKS

The banking and brokerage firm of Brooks & Company, Scranton, was founded by Reese G. Brooks, deceased, and his three sons, of whom John H. has ever been considered the active head of the firm.

Reese G. Brooks, who became one of the best known, prominent and well liked citizens of Scranton, was born at East Mountain, near Scranton, December 25, 1846, died June 12, 1907. He was educated in the public schools of Hyde Park, but abandoned school in 1863, and enlisted with the volunteers who marched to repel Lee's invasion of Pennsylvania in 1863. Upon his return from that campaign he entered the employ of the Delaware, Lackawanna & Western Railroad, but in 1864 again enlisted, serving with the Union army in eastern Tennessee, until honorably discharged in 1865. Returning then to Scranton he engaged in mining for three years, then became superintendent of the Capouse Colliery of the Lackawanna, Iron and Coal Company. He was a valued officer of that company and was successively promoted until he became inside superintendent of all their mines and later general superintendent of their coal department. He later became an independent operator, his operations covering extensive collieries in the valley. In 1884 he organized the Greenwood Coal Company, and in 1892 the Langcliffe Coal Company. At one time he controlled the Laffin Coal Company, also the Lee Coal Company and was president of the Bridge Coal Company. Active as he was in the coal industry, he had official and stockholding relations with many of Scranton's most important industries and with her financial institutions. He was president of the Dime Deposit and Discount Bank (before the merger) and held directorships in the Scranton Trust Company, and the Title Guaranty and Surety Company, the Westside Bank and others of perhaps lesser importance. Nor was he so immersed in business that he neglected any of the duties of a good citizen, but served the municipality of Scranton faithfully and efficiently for many years as a member of the school board, president of the poor board, the board of control and for seven years as city treasurer. He was a Republican in politics and for several years was chairman of the Lackawanna county central committee. Progressive and public-spirited he aided in all movements that tended to advance the public good, not only with his means but by his personal effort and influence. He enjoyed travel and after thoroughly visiting all parts of the United States, Mexico and Canada, he visited Europe in 1896, touring the Continent and the British Isles. He was an invalid for several months prior to his demise, but always retained his interest in current affairs.

He married Mary A. Morgan, who died March 27, 1905. Children: Margaret, married William R. McClave, of Scranton; Thomas R., president of the North Scranton Bank, married Bertha Griffin; George G., of Brooks &

Company, married Grace Williams; John H., of whom further; Cora M., married Willard Matthews, of Scranton.

John H. Brooks was born in West Scranton, Pennsylvania, September 16, 1872. His early education continued in the West Side schools until fourteen years of age, followed by four years at Scranton Central High School and a college preparatory course at The School of the Lackawanna. He then entered Princeton University, whence he was graduated B. S., class of 1895. His years at the university were not only profitable years of earnest study, but of fame in the college world of athletics. He was a member of the baseball team during each of his four years, and in his senior year, 1895, was captain of the team. For three years he was one of the players selected for the All American College team and was also an expert tennis player. His college club was the Tiger Inn.

After completing his university course he at once began an active business life in connection with his father's coal interests, locating for several years in Scranton, then moved to Pottsville in charge of the Brooks colliery interests in Schuylkill county. In 1905 he returned to Scranton and organized the banking and brokerage firm of Megargle & Brooks, which the year following became Brooks & Company, the principal members being Reese G. Brooks and his three sons, and continues as originally formed with the exception of the honored father, whose connection was terminated by death in 1907. This firm, of which John H. Brooks has ever been the honored head, transacts a large business as bankers and brokers. John H. Brooks is a member of the New York Exchange, his membership dating from the year 1908. He is a director of the Scranton Savings and Dime Bank, the Girard Life Insurance Company, of Philadelphia, the Spencer Heating Company, of Scranton, also is interested in many other enterprises of importance. With a genuine interest in young men and their welfare, he has for many years been active in the work of the Young Men's Christian Association, and is now president of the Scranton Association. He is also a trustee of the Scranton Public Library and of the First Presbyterian Church. In political faith he is an independent Republican, but not active, save in the cause of his friends whom he is ever ready to serve with his influence and his ballot.

Mr. Brooks has never lost his interest in athletic sports, but is an active member of the Scranton Club, holding the club bowling record, is their best tennis player, and, although now aged forty years, is still the expert at that game, always considered a young man's game. He also excels at the game of golf, being a player of national reputation, and in 1901 was chosen on the All America team to play Canada. All out-of-door sports appeal to him, but in those mentioned he takes the greatest delight and in those he excels to a degree unusual for his years.

Mr. Brooks married, April 5, 1904, Augusta Archbald, of Scranton. Children: Ruth, Mary, John H. (2), James Archbald. The Brooks family residence is at No. 535 Monroe avenue.

---

### JAMES ALEXANDER LINEN

In the financial world of Scranton there is no name that has ever been more closely associated with the qualities of honor, integrity and ability than that of James A. Linen. Having spent most of his business career in the city he has been a participant in its marvelous expansion, and in his different relations with the First National Bank has become known as one of the safest and most capable financiers of Scranton.

It is interesting to note that while every preference and instinct of James

A. Linen led him into the field of finance, by every law of heredity he should have been imbued with artistic rather than practical desires, inasmuch as his father, George Linen, was widely known as one of the most talented artists of his day. George Linen was born in Greenlaw, Scotland, April 29, 1802. Early evincing artistic tastes and innate ability, he was entered at the Royal Scottish Academy at Edinburgh, where masterly training by artists of the highest repute led his brush from its bold and daring strokes into the refined and softened lines of a more delicate and more beautiful art. In the excellent course of instruction he received at the academy he developed into a portrait painter of rare accuracy in faithful and lifelike portraiture. Crossing into England, he there remained for several years, gaining steadily in prominence and rapidly approaching the height of perfection in his art. In 1834 he came to New York, where he opened a studio which was soon the scene of busy activity, many of the most prominent men of the day in the business and public life of the metropolis sitting before his easel. He was constantly at his work, daily adding to his fame as well as to his material prosperity. He made cabinet portraits his special field and one of his masterpieces, painted five years after his arrival in the United States, received a medal as the best specimen of cabinet portrait painting shown at the annual exhibition of the National Academy of Design. Among the official dignitaries of the day who sat in his studio were Henry Clay and Daniel Webster, of whom he painted such excellent likenesses, that from his portraits are made the vignettes which appear upon certain United States treasury notes of high denomination.

Shortly after his coming to New York, Mr. Linen purchased a farm in Greenfield township, Lackawanna county, Pennsylvania. Here he spent the summers with his family and here was born James Linen in the year 1840. It is an interesting fact that while living on this farm Mr. Linen was instrumental in persuading his brother-in-law, Mr. James Dickson, to move from Toronto, Canada, with his family and settle in Lackawanna county. Mr. Dickson's sons, Thomas H. and George L. are mentioned elsewhere in this history.

In literary, as in artistic, fields of culture, George Linen was exceedingly well-versed, and was, withal, a brilliant conversationalist, his charming manners and manly graces making him much sought after socially. His well balanced mind and deep knowledge of human nature, gained from a study of the characters as well as the faces of his patrons, saved him from being over-impressed by the adulation and profuse flattery of the circles in which he moved, and kept him ever sincere and natural. During his exceedingly busy life he had saved a modest competence, and after he had tasted all of the delights of fame and popularity, he purchased a farm at Bloomingdale, New Jersey, naming it Glenburne, a word from his native Caledonian tongue, meaning "the rivulet by the ravine." He here retired to spend his later days, forsaking his brushes and palette except for the occasional painting of a portrait of one of his children, or when he again took up his tools to gratify the wish of an old friend. It was highly fitting, that, to round out a life of such rare beauty, there should be a deep sense of religious duty and obligation. George Linen was blessed with an absolute and high faith in Divine Providence, and with the full measure of his devotion lived a life free from reproach or blame. He was a member of the Reformed church, simple, sincere and earnest in his worship. He was the father of nine children by his marriage with Sarah Davis.

James Alexander Linen, son of George and Sarah (Davis) Linen, was born in Greenfield township, Lackawanna county, Pennsylvania, June 23,



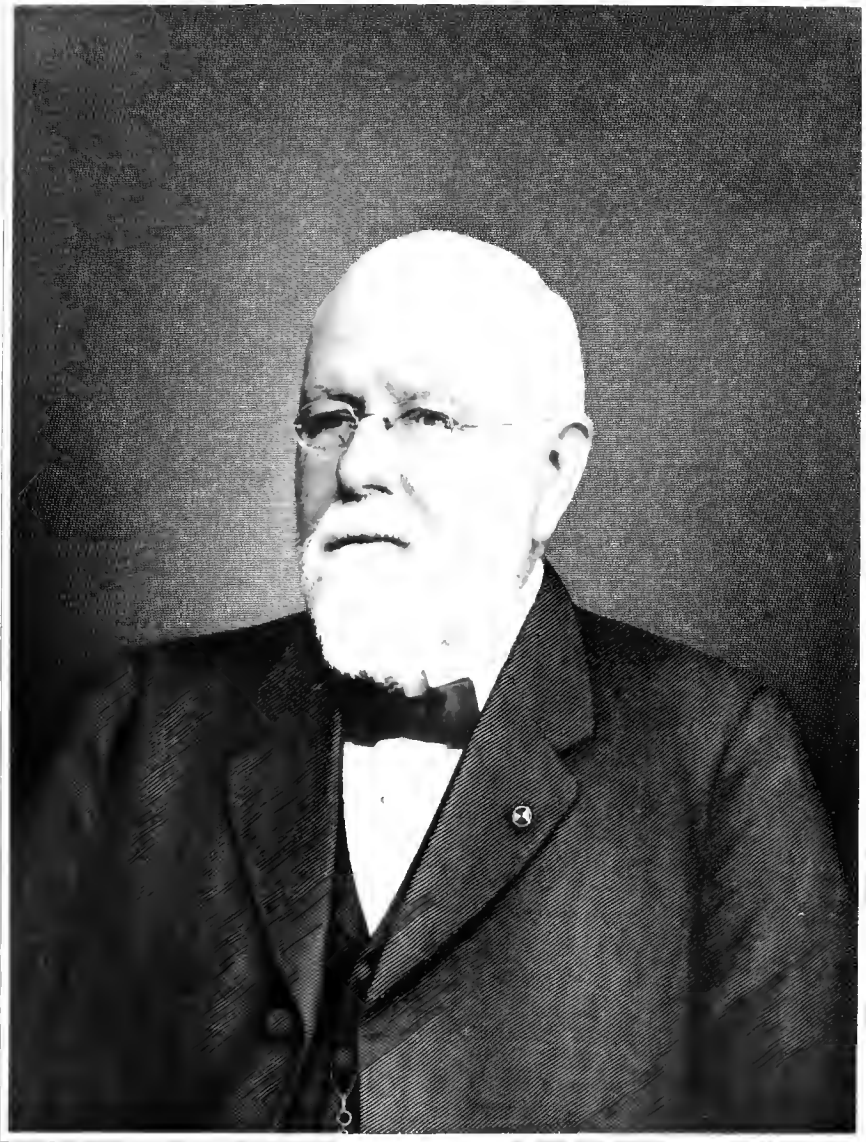

*James A. Lincoln*



1840. In Newark and in New York City he received a thorough education extending as far as high school training. In early youth he entered the office of a note broker in Wall street, and during the five years of his employment there gained a deep insight into monetary affairs and the means of their adjustment, inflation and depression, which proved invaluable to him in the later years of his life, when he became so important a factor in the financial affairs of Scranton. When he was about to embark upon his independent career the outbreak of the Civil War occurred, and patriotic love of country being strong in his youthful heart, he laid aside his plans for business until a more propitious occasion and enlisted in the Twenty-sixth Regiment New Jersey Volunteers, September 19, 1862, as a private, but soon rose to the rank of lieutenant. He completed nine months service in the Army of the Potomac, which saw much strenuous action in the entire war, his regiment participating in the battles of Chancellorsville and Fredericksburg, also in the Gettysburg campaign, engaging in the first conflict of that historic manoeuvre. Lieutenant Linen was subsequently transferred to the Army of the West and for eighteen months was stationed at Camp Nelson, Kentucky, as disbursing clerk for Captain T. E. Hall, chief quartermaster for the Ninth Army Corps. When peace had once more fallen upon the country, he became identified with the National Guard of Pennsylvania, and at the organization of Company D, Thirteenth Regiment, was elected first lieutenant, later becoming captain and serving for six years.

In February, 1865, Mr. Linen accepted a position as teller in the First National Bank of Scranton and three months later was advanced to cashier, a position he occupied with conspicuous ability for the exceedingly long term of twenty-six years. During this time he was held high in the estimation of the other officials of the institution and played an important part in maintaining the solvency of the bank during the period of readjustment that followed the hysterical financial conditions of the Civil War and the reconstruction years. In all this troublous time the First National Bank, owing to its wise and far-sighted executive heads, not only was in no danger itself but was able to assist other and less fortunate concerns which were about to become links in the long chain of failures that were occurring hourly. In October, 1891, Mr. Linen received the election as president of the First National Bank, the culmination of long years of faithful service and unceasing devotion to its best interests. In his new position he was quickened to new efforts in its behalf and for twenty-two years guided it with clear and capable judgment, the bank retaining its position at the head of the financial institutions of Scranton and among the strongest in the United States. As proof of its success are the dividends which it declares, these having increased from ten per cent. in 1864 to sixty per cent. at the present time, the largest dividend ever paid by any Scranton corporation. In 1913 Mr. Linen was succeeded in the presidency of the First National Bank by Charles S. Weston, descending from the position he had dignified for so many years to make way for a new generation of younger blood. Upon retiring from his office he accepted the chairmanship of the board of directors of the bank, thus not entirely severing the bonds which have been so closely welded in the past forty-eight years. He is also one of the directors of the Delaware & Hudson Railroad Company.

Mr. Linen has frequently been called upon to act in the capacity of executor, trustee or administrator of large estates, and has filled many responsible offices requiring the services of an experienced financier, not the least of which was his appointment as assignee of the defunct Scranton Trust Company and Savings Bank, whose affairs he settled in a prompt and satisfactory manner, fully justifying the confidence placed in his executive powers.

Mr. Linen is a member of the Military Order of the Loyal Legion, Pennsylvania; a member of Ezra Griffin Post, Grand Army of the Republic, and the Country Club, the two latter being Scranton organizations. With his wife he is a member of the Second Presbyterian Church of Scranton, in whose different activities both take a great amount of interest.

He married, December 17, 1889, Anna C. Blair, daughter of James Blair, of Scranton. Children: Margaret Clark and James Blair, both died in childhood; Mary Belle, a graduate of Miss Masters' School, at Dobbs Ferry; Frank Insley, a graduate of Princeton University; James A. Jr., a graduate of Williams College, was a receiver of the Scranton Steam Pump Company, now reorganized, and he is vice-president and treasurer of this, also vice-president of the United Service Company; now one of the councilmen in Scranton.

To Mr. Linen there must surely come a sense of satisfaction in his own achievements and a feeling of pride in the generation of his name succeeding him. To be active in such a degree as he has maintained until past the biblical three score and ten is a record rarely equalled and almost never surpassed. It has been said that years are not always the true measure of life but that events are sometimes the best calendar. By the latter standard Mr. Linen must indeed be a centenarian; by the former, the calendar is the only indication of his seventy-three years, his mind preserving all of its youthful vigor and power.

---

#### ARTHUR D. DEAN

The Dean family is an exceedingly ancient one in this country, Walter Dean, the American progenitor, taking the freeman's oath in Massachusetts, December 4, 1638. In the six generations of the family from the emigrant ancestor to Isaac, the father of Arthur D. Dean, of this chronicle, the members of the family have been active in the different departments of life, civil, professional, and industrial. The pioneer spirit has always been strong in all of the name and one of the family was almost always among the first settlers in a newly developed section of the country. An evidence of this is found in the following abstract of a deed of sale:

"Barnet Dickson, Voluntown, Windham county, Connecticut, to Ezra Dean, of East Greenwich, Kent county, Rhode Island, consideration nine pounds, grants and conveys unto said Ezra Dean, his heirs and assigns forever, the one full part, right or share in the Susquehanna purchase, so-called, which whole right, part, or share, individual, I, the said Barnet Dickson, purchased as being a partner or member of the body of men of the aforesaid Colony of Connecticut, who jointly purchased the said Susquehanna tract of land, commonly so called, of the Chief Sachems and Nations, proprietors of the aforesaid country or land, dated 28 January, 1760; recorded 8 March, 1760, Acknowledged before John Smith, justice of the peace of Voluntown, Windham county, Connecticut."

Isaac Dean, father of Arthur D. Dean, was born in Abington, Luzerne (now Lackawanna) county, Pennsylvania, June 9, 1811. His early life was spent on his father's farm, in the clearing and cultivating of which he became accustomed to the hardest kind of labor. His opportunities for directed study were few, but he learned many lessons in the school of experience and hard knocks that left a life-long impression upon him. Although handicapped by his lack of education he marshalled his forces at hand slowly but surely to build the foundation of a fortune. He hauled the grain raised on his farm to Carbondale and Honesdale, selling it to the Delaware & Hudson Company, and also opened a saw mill on Sheik's Pond, now Lake Sheridan, and cleared his father's land and his own of all the marketable lumber thereon. In 1843,

after his marriage with Polly Searle Heermans, daughter of Henry Heermans, the first merchant of Providence, Pennsylvania, he bought fifty acres of land from his uncle, George Gardner, and sixty acres adjoining the family homestead, erecting thereon a comfortable house. He then, in connection with his farming operations, began a butchering business, supplementing this by buying live stock for drovers at a commission rate. By the judicious investment of his earnings he began to amass a considerable fortune, augmented by the proceeds from the sale of some property inherited by his wife. Upon the organization of the Second National Bank of Scranton, in 1863, Isaac Dean was an active promoter of the enterprise, acting upon the advice and under the leadership of his brother-in-law, W. W. Winton, in whose judgment and integrity he placed great confidence. He also became a partner in the banking house of Winton, Clark & Company, which later obtained a charter under the name of the Citizens and Miners Savings Bank and Trust Company of Providence. Both of these banks failed, the catastrophe sweeping away the greater part of Mr. Dean's fortune, although he was able to live comfortably for the rest of his life; Mrs. Dean died July 8, 1868, and Mr. Dean, November 15, 1902.

Arthur D. Dean, son of Isaac and Polly Searle (Heermans) Dean, was born on the farm purchased by his father from George Gardner, in Abington township, Lackawanna county, Pennsylvania, January 29, 1840. He acquired his early education by attendance at the public schools, and so active was his mind and so strong his liking for academic work that when only fifteen years of age he entered upon a scientific course of study at the University of Lewisburg, later Bucknell, completing the same in 1867. During the winter of 1867-1868 he taught school in the district near his home now known as La Plume, and in 1868 resumed his studies at East Greenwich Academy, and at the beginning of the fall term entered the classical course of Brown University, Providence, Rhode Island. He here was graduated A. B. in the class of 1872 and three years later the degree of Master of Arts was conferred upon him. Having his remarkably fine scientific and classical education for a firm foundation, in 1872 he enrolled in the law school of the University of Michigan at Ann Arbor, and afterward entered the office of Agib Ricketts, attorney at Wilkes-Barre, as a student at law. He was admitted to the bar January 5, 1875, and for the first year of his active practice remained in the office of his preceptor. He then took office with Elliot P. Kisner and Frank C. Sturges as a working rather than a nominal partner, and in 1879, a year after Scranton had become the county seat of Lackawanna county, came to that city, where he has been ever since engaged in the practice of his profession. As a lawyer Mr. Dean is known to be reliable and talented, civil practice being his especial field. Intimately acquainted with all legal technicalities, his clients are assured that every effort consistent with dignity and honor will be extended in their behalf and under his skillful handling no just cause could go down in defeat. Besides his professional duties, Mr. Dean is interested in the lumber business and is a director of the United States Lumber Company, which controls vast lumber interests, owning 300,000 acres of yellow pine in Mississippi, where the company has a controlling interest in the Mississippi Central Railroad, extending from Hattiesburg to Natchez, with headquarters at Hattiesburg, Mississippi. He has also been treasurer of the Board of Trade Real Estate Company, of Scranton, ever since its incorporation, and this company owns the Board of Trade Building.

He married, May 11, 1882, Nettie E., only daughter of Arnold Clark and Isabel (Green) Sisson, of La Plume, Pennsylvania. Mrs. Dean died November 25, 1901, and Mr. Dean still remains unmarried. Children born of this union are: 1. Carroll, born March 27, 1883, a graduate of the Massachusetts

Institute of Technology, an electrical engineer in the navy yard at Norfolk, Virginia; married Christine Parker, daughter of C. M. Parker, and has two children—Isabelle C. and Arthur Parker. 2. Russell Heermans, born March 19, 1885, lives in Waverly, Pennsylvania; married Mrs. Elizabeth Dunn, daughter of Dr. A. B. Hand, and they have a son, Gobel Davis Dean. 3. James Davis, born July 22, 1887, graduate of Brown University, class of 1909, and follows teaching as a profession. 4. Miriam Isabel, born October 1, 1893, a student at Wellesley College, class of 1916. 5. Nettie Catherine, born November 22, 1901, a student of the Waverly High School.

Mr. Dean, during his active life, has attained that pleasurable degree of success and prosperity which comes to a man after conscientious attention to professional duties and intelligent investment and application of his resources. Of pleasing address and personality, he is gifted with the power of making and holding friends, numbering in his most intimate circle of acquaintances the most talented of the legal profession and the most successful of Scranton's business men. His home for the past twenty years has been on a farm in the borough of Waverly, Pennsylvania. He has been president of the school board of Waverly borough for fifteen years; is a member of the Independent Order of Odd Fellows and the Heptasoph; in college the Alpha Delta Phi fraternity, Phi Beta Kappa, an honorary society.

#### HAMPTON C. SHAFER

The best evidence of a man's standing in his community is the attitude that is taken by the public toward the business enterprises of which he is the head. When a business proposition is presented to a man, his first query is: "Who is at its head?" The next is, "Will it pay?" Answer the first question satisfactorily and support is assured. Applying this test to Hampton C. Shafer, the result is that his standing among men of capital is found to be of the highest, as when in April, 1913, he began the organization of the Lincoln Trust Company, the response was immediate and so generous that on the 7th of June following, the doors of this newest of Scranton's financial institutions were opened for business with Mr. Shafer as its president. Mr. Shafer is a grandson of Peter Bernard Shafer, of German parentage, who settled in the northern part of Sussex county, New Jersey, where he became a man of importance, serving his state as a member of the legislature. His son, Casper, married Caroline, daughter of Judge Hazen of Sussex county. Casper Shafer in early life was a miller, later a farmer and landowner. Children: Nathan Hazen, died in December, 1911; Abraham Edwin, now living in New Jersey; Sarah Elizabeth, married Edgar V. Kennedy, whom she survives a resident of Tranquility, New Jersey; E. Louise, died in August, 1913; Hampton C. The parents were members of the Presbyterian church, in which Casper Shafer served as elder.

Hampton C. Shafer was born in Sussex county, New Jersey, September 18, 1853. He was educated in the public schools, Schooleys Mountain Seminary and the New Jersey State Model School at Trenton. He began business life as clerk in a Trenton book store, but after six weeks' experience, entered the employ of the Lambertville (New Jersey) National Bank as clerk. He continued with this institution nearly eight years, rising through the several degrees of service to the post of assistant cashier. In January, 1881, he came to Scranton as cashier of the Scranton Savings Bank, a position he held until 1913. During these years he had firmly established himself in the confidence of the banking public and won an enviable position in the local world of finance, his upright, manly life and financial acumen forming the combination essential

to the man who appeals to the public for patronage. In April, 1913, after carefully maturing his plans he formed the Lincoln Trust Company, was elected president, and in June following began business. The success of the new institution was immediate and most gratifying to all concerned, but doubly so to the chief executive to whom it came as an indorsement of his fitness to safeguard the interests of his many patrons. He is also a director of the Trout Lake Ice Company and has other business interests. He is a member of the Second Presbyterian Church, which he serves officially, his wife also being an active member of the church and its societies. He is a director, secretary and treasurer of the Country Club.

Mr. Shafer married, Mary Elizabeth, daughter of Milton, and granddaughter of James Blair, November 13, 1891. His only child is Margaret Linen Shafer.

---

#### RONALD PRENTISS GLEASON

Ronald Prentiss Gleason, principal of the Technical High School and William T. Smith Manual Training School, is a native of the State of Massachusetts. He is descended from Thomas Gleason, or Leeson, as the name was sometimes spelled, who came from England and settled in Watertown, Massachusetts, prior to 1650. His great-grandfather was Phineas Gleason, of Westborough, Massachusetts, who served as a soldier in the Revolutionary War. He is the son of Josiah Parsons and Ellen (Tidd) Gleason, of New Braintree, Massachusetts.

The American ancestor of the Tidd family settled in Lexington, Massachusetts, in the first half of the seventeenth century. Seven of his descendants represented the family in that small band that assembled on the village green at Lexington, on April 19, 1775, and made an effort to stop the onward march of the British under Major Pitcairn.

Ronald P. Gleason is one of ten children. He was educated in the public schools of Massachusetts and was graduated from the Worcester Polytechnic Institute with the class of 1887, receiving the degree of Bachelor of Science in the mechanical engineering course. For two years he taught in the high school at Washington, District of Columbia, then crossed the continent to accept the position of supervisor of manual training in the public schools of Oakland, California, where he remained for eleven years. When the call came for teachers to serve in the Philippine Islands, he was among the first to respond. He was appointed by the government at Washington as the ranking teacher in charge of the 540 or more who sailed from San Francisco, July 23, 1901, on the United States army transport, *Thomas*. Mr. and Mrs. Gleason remained in the Philippine Islands for four years. During all this time Mr. Gleason was superintendent of the Philippine School of Arts and Trades at Manila. In January, 1905, he resigned his position and, with Mrs. Gleason started for home visiting Japan, China, Java, the Federated Malay States, Burma, India, Europe.

When the Technical High and William T. Smith Manual Training School buildings were completed in 1905, Mr. Gleason was elected the first principal, a position he still holds. His services have met with the highest approval of all connected with and responsible for the welfare of the schools, and he has raised that institution to a high plane of efficiency and usefulness. He has gathered together a faculty of exceptionally able teachers, who give their best to the school and as a result the Technical High School has become an institution of which Scranton may well be proud. Mr. Gleason is a member of

the Pennsylvania State and National Education associations, and also of the National Society for the Promotion of Industrial Education.

Mr. Gleason married, in 1890, Nellie Miles Rood, daughter of the late Dr. James T. and Ellen (Miles) Rood, of Massachusetts. Dr. Rood was a surgeon in the Massachusetts volunteer militia and served his country practically all through the Civil War, being stationed for the greater part of the time in the Shenandoah Valley. Since coming to Scranton, Mrs. Gleason has taken an active interest in the life of the city and has been president of the Century Club since its organization in 1911.

---

#### DAVID CHASE HARRINGTON

David Chase Harrington, of Scranton, Pennsylvania, the distinguished jurist, is not only an eloquent advocate, capable of swaying juries, but an able lawyer, preparing and conducting most important cases with strategic skill and eminent success. It is especially noteworthy that in achieving his eminence at the bar he has relied not more upon his eloquence and genius, than upon the unwearied diligence with which he studied and toiled. His family has been a noted one in both lines of descent.

(I) William Harrington, great-grandfather of David Chase Harrington, was one of three brothers who came from England to this country and settled at or near Chatham, Columbia county, New York, where he married and became the father of six children. He bore his share bravely in the Revolutionary War.

(II) James Harrington, son of William Harrington, was born in 1774, and died in the fall of 1814 from the effects of a fever contracted while in service in the War of 1812. His widow, Sarah (Purdy) Harrington, removed with their eight children to Pine Hill, Ulster county, New York.

(III) James (2) Harrington, son of James (1) and Sarah (Purdy) Harrington, was at first a carpenter and builder, later a manufacturer of furniture. He married Emeline Harriet Chase.

The Chase family is of ancient English origin, the name being derived from the French word "Chasser," meaning "to hunt." The ancestral seat of the branch of the family from which the American line is descended was at Chesham, Buckinghamshire, through which runs a swift stream, the Chess, which gives its name to the place. The Chase arms are: Gules four crosses patonce argent (two and two) on a canton azure a lion passant, or. Thomas Chase, of the seventh generation of the English family, and the progenitor of the family in America, came to Plymouth Rock in 1629, and removed to Hampton, New Hampshire, in 1644. He married Elizabeth Philbrick. Isaac, son of Thomas and Elizabeth (Philbrick) Chase, married (first) Mary Perkins, (second) Mary Tilton. Joseph, son of Isaac and Mary (Tilton) Chase, married Lydia Coffyn, a great-granddaughter of Tristram Coffyn (Coffin). Abel, son of Joseph and Lydia (Coffyn) Chase, married Mercy Mayhew. Zephaniah, son of Abel and Mercy (Mayhew) Chase, married (first) Abigail Skiff, (second) Love (West) Skiff. He removed with his family from Martha's Vineyard to what is now Jewett, Greene county, New York. David, son of Zaphaniah and Love (West) (Skiff) Chase, married Abigail Pratt, for whose family the town of Prattsville, Greene county, New York, is named. Emeline Harriet, daughter of David and Abigail (Pratt) Chase, while teaching school in Hunter, Greene county, met James (2) Harrington, whom she married.

(IV) David Chase Harrington, eldest child of James (2) and Emeline Harriet (Chase) Harrington, was born December 8, 1834, in that part of Lexington which is now Jewett, Greene county, New York. He learned to read





*Yours Truly*  
*David C. Harrington.*  
"



sitting on his father's lap at family prayers in the morning. Before his father commenced to read he would point to the capital letters, his father telling him their names, and then he would watch his father read, and when he was two and one-half years old he could read as well as he can now. He has no recollection of his first going to school. At the age of ten years he had been so far in the text book as the teacher in the common schools in Greene county, New York, could take him, and that did not include all of arithmetic and very little of grammar. When at that age, a gentleman, who had graduated either from Harvard or Yale College, wished to study for the ministry, and not having the money to pay his expenses through the university he came to Jewett and taught school there for two years. Mr. Harrington went to this school during the last year and a half of this gentleman's tuition, and studied arithmetic, algebra, trigonometry, geometry, grammar, astronomy, botany, commenced the study of Latin, and went through the Latin grammar and commenced to read this language by the time he was twelve years of age.

His father was engaged in business as a carpenter and builder and the last piece of work he did as a carpenter was to erect a large building in Bushnellsville, Ulster county, New York, where cane and wood seated chairs were manufactured for the wholesale trade. When the building was completed they wished him to instal the machinery, which he did successfully, and everything was done in so masterly a manner, that he was offered the superintendency of the shops. He accordingly gave up his carpenter business and moved to Bushnellsville, December 24, 1847, and became head of this establishment.

As there was no object in sending young Harrington to the district school to review what he already knew, he was given work in the finishing department of the factory in December, 1848, when he was fourteen years of age, and thus commenced the business portion of his life. In 1849 his father decided to go into the furniture business in Pennsylvania, and entered into a partnership with the man who had charge of the finishing department of the Bushnellsville factory. At that time there were no railroads by which he could reach Providence, so he was obliged to send his household effects by teams to Rondout, Ulster county, New York, and by boat on a canal to Honesdale, Wayne county, Pennsylvania, and from there on the Gravity road to Carbondale. June 18, 1849, he left for Providence in a carriage with his family, and arrived at Providence, Luzerne county, Pennsylvania, June 23, 1849. Young David C. was still employed in the finishing department of his business, and the partnership which he had formed was continued until 1851.

The construction of the Delaware, Lackawanna & Western Railroad was commenced from Scranton to Great Bend in 1850 and completed in the summer of 1851. The Lackawanna Iron and Coal Company owned the real estate in the village which was afterwards the borough, now the city of Scranton, and would not sell lots to outsiders. They owned all the property themselves, intending to keep their own employees there, but when the railroad was completed, the Lackawanna Iron & Coal Company laid out their land in lots and sold them to any who would buy. David C. Harrington's father bought a lot and built a residence and wareroom, completed it and moved into it, January 6, 1852. At the rear end of the lot was the building used as a shop.

David Chase Harrington had learned to finish furniture well although he had had no special instruction in the ornamentation of it. He took to this occupation naturally, could varnish and polish, imitate the finest woods, and when it was necessary to put on ornamentation, was able to do that in a most satisfactory manner. His father was also in the undertaking business, and as it was difficult to obtain anyone to engrave plates for the coffins, a

set of engraving tools was bought, and David C. successfully engraved the first name plate that was required, and attended to this part of the business as long as he was associated with his father. In 1854-55-56 he played the cornet in the brass band in Scranton and this gave him good chest expansion and was one of the means of keeping him in good health. He has a chest expansion of six inches to-day, and ascribes much of this development to his practice on the cornet.

He had never heard a word of German spoken until the family removed to Pennsylvania. Two of the cabinet makers in his father's shop in Scranton were Germans, who could not speak a word of English. David C. commenced the study of German in the fall of 1852 and by the following spring he could read, write and speak German sufficiently well to communicate with the men on matters of business, and could go into the wareroom and sell goods to customers who were not able to understand a word of English. He was frequently asked by Germans, concerning the part of Germany he came from. Years ago, when he was living in Philadelphia, the lawyers, knowing that he spoke the German language, and there being only one interpreter to go to the different rooms, when his services were already in request and a witness could not speak or understand English, Mr. Harrington was requested to act as interpreter.

While engaged with his father in the furniture business he also learned to work at the bench and to make articles of furniture, and he did turning at the turning lathe and all kinds of work with the exception of carving. When he had attained the age of nineteen years his father sent him to New York alone to purchase the hardware and upholstering materials and other things needed in the furniture business, and after he had successfully accomplished this it was always his province afterwards. He now has in his home seven landscapes in oil that he himself painted when he was twenty-one years old. When he attained his majority his father took him into partnership, but at the end of one year this was dissolved as David C. had expressed the fixed determination to make law his life work.

David Chase Harrington commenced reading law in April, 1858, studying during the second year in the office of a lawyer. At this time there were four villages within a mile of each other—Providence, Hyde Park, Scranton and Dunmore. During the first winter David C. taught school in Dunmore. As he lived in Scranton he was obliged to walk a mile to Dunmore every morning, and the same distance upon his return at night. In this school some of the pupils were young men of almost his own age, one of whom was afterward a judge in the Court of Common Pleas of Lackawanna county. There were more than 100 students in this school and Mr. Harrington had an assistant. There was but one room in the schoolhouse and a blackboard was placed at the rear of this room. It was therefore necessary for Mr. Harrington and his assistant each to use an opposite side of the blackboard to illustrate the subjects they taught.

The dates of admission to legal practice of Mr. Harrington are as follows: Court of Common Pleas of Luzerne county, Pennsylvania, May 7, 1860; Court of Common Pleas of Northampton county, Pennsylvania, August 28, 1862; Supreme Court of the State of Pennsylvania, June 20, 1866; Mayor's Court of Scranton, Luzerne county, Pennsylvania, October 1, 1866; United States Circuit and Districts courts, western district of Pennsylvania, August 5, 1867; Mayor's Court of Carbondale, Luzerne county, Pennsylvania, August 15, 1867; Court of Common Pleas of Dauphin county, Pennsylvania, August 24, 1868; Court of Common Pleas of Wyoming county, Pennsylvania, April 19, 1869; District Court of Philadelphia, Pennsylvania, December 20, 1870; Court of

Common Pleas of Philadelphia, December 24, 1870; United States Circuit and District courts, eastern district of Pennsylvania, February 18, 1871; Court of Common Pleas of Bucks county, Pennsylvania, April 14, 1874; Supreme Court of the United States, Washington, District of Columbia, February 2, 1876; Court of Common Pleas of Schuylkill county, Pennsylvania, January 23, 1882; Court of Common Pleas of Lackawanna county, Pennsylvania, August 15, 1898; United States Circuit Court of Appeals, Richmond, Virginia, December 2, 1906.

In 1878 Luzerne county was divided and Lackawanna county was formed with Scranton as the county seat, and Wilkes-Barre remained the county seat of Luzerne county. Mr. Harrington won his first case, and the opposing lawyer, a prominent member of the bar, was so impressed with his conduct of it that he took him into partnership, and this was continued until the outbreak of the Civil War. April 1, 1862, Mr. Harrington removed to Wilkes-Barre. In 1863 he laid aside his professional duties to respond to the call of Governor Andrew G. Curtin for emergency men to repel the invasion of Pennsylvania by the Confederate army under General Robert E. Lee. He enlisted as a private in Company K, Thirteenth Regiment Pennsylvania Volunteers, Colonel William N. Monie commanding. Mr. Harrington's company was the first to be mustered in under that call, and they were stationed at Camp Curtin, near Harrisburg, when that city was threatened by the Confederates, at the time of the battle of Gettysburg. On Saturday, July 3, the regiment was filled and ready to march to Gettysburg, but Sunday, July 4, the great battle at that place was ended, therefore Mr. Harrington was not in active service. With his command he was honorably discharged, July 26, 1863.

While Mr. Harrington was in Wilkes-Barre he was in partnership with Caleb E. Wright, one of the old members of the bar, and this association was continued until 1870. While living in that city there was a great deal of malaria in the Wyoming Valley, and Mrs. Harrington suffered from fever and ague for the greater part of the time and was subjected to bilious fever once or twice each year, and the physician said that if she did not remove from the valley she could not survive. This was the cause of the dissolution of the partnership with Mr. Wright, in December, 1870, and within one week Mr. Harrington and his family were in Philadelphia, where he practiced law for more than thirty-one years.

After Mr. Harrington had left Wilkes-Barre the lawyers of that city gave him a Christmas present, in 1872, of a fine full-jeweled gold watch of Waltham make with the inscription on the case as follows: "Presented to David C. Harrington by his brethren of the Luzerne Bar, December 25, 1872." This he values highly, and it is an excellent timekeeper to the present day.

Hon. F. Carroll Brewster, who had been a judge of the Court of Common Pleas of Philadelphia, was attorney-general of the State of Pennsylvania. He was obliged to spend all his winters in Harrisburg and in summer could only escape the importunities of his numerous clients by taking refuge in Europe. In June, 1872, he requested Mr. Harrington to take charge of his legal business. There were two lawyer assistants and a bookkeeper in Mr. Brewster's office, and in order to take charge of this extensive business and not neglect his own, it became necessary for Mr. Harrington to take an assistant lawyer in his own office. Judge Brewster then went to Europe each summer for three years and during this time Mr. Harrington had full charge of the business, trying the cases, preparing briefs, etc. When his term of office as an attorney-general expired, Judge Brewster returned to his practice, and Mr. Harrington was enabled to continue his personal practice.

In 1898 he commenced to represent the International Text Book Com-

pany in some copyright suits and attended to some of its other legal business, and was requested in March, 1902, to return to Scranton and take charge of all the legal business of this corporation. He has succeeded in winning many suits for the company, some of great importance, one on the question of "Doing Business," and that the company is engaged in interstate commerce. He contended that as it was giving instruction through the mails by means of selling printed books to students, and giving written instruction from Scranton, each letter written to a student in another state, is a book, and is interstate commerce. Courts in three of the states decided to the contrary and that the company could not maintain a suit. The first case to be appealed to the Supreme Court of the United States arose in Kansas and was decided in favor of the company, April 4, 1910, and is reported in 217 U. S. 91. In that case it was held that giving instruction through the mail is interstate commerce, and that the company need not file its charter in any state of the United States. Other cases appealed from Wisconsin and Vermont were decided, November 7, 1910, in conformity with the Kansas case and are reported in 218 U. S. 664, so that it is now settled that a letter is a book and the selling of information and giving instruction by correspondence through the mail is interstate commerce.

In February, 1910, the principal of the School of Law died, and on May 16, 1910, Mr. Harrington was appointed principal of the School of Law, and now has charge of that department. The instruction business in the law courses of the company are very important, as the instruction that is given to students must be accurate in every particular. The two departments require all of his time. His health has always been good. He has never been ill in bed, and at the present time is able to be at his desk in his office at eight o'clock in the morning, and he is sometimes the last to leave if there is any correspondence to be signed.

Mr. Harrington united with the Presbyterian church in Greene county, New York, in the spring of 1849. When his father moved to Providence a letter was taken, and he united with the Presbyterian church in Providence. When he removed to Scranton in 1852 his letter was taken from the church in Providence and in November of the same year he united with the First Presbyterian Church of Scranton, and his sixtieth anniversary occurred in November, 1912. For many years he was very active in Sunday school work and in organizing Mission Sunday schools, but since returning to Scranton he has been obliged to abandon work of this character owing to the fact of his being frequently away on travels connected with his business pursuits. At the present time (1914) Mr. Harrington is still enjoying excellent health, is as vigorous as many men far his juniors in point of years, and there appears to be every prospect of his attaining a greater age than his maternal grandfather, David Chase, who lived to the age of eighty-five years, his own father, who died at the age of ninety-four, and his great-grandmother Harrington, who was ninety-eight years old at the time of her death.

Mr. Harrington married (first) September 11, 1856, Ann Jeannette Kemmerer, born in Monroe county, Pennsylvania, January 1, 1849, died in Scranton, Pennsylvania, November 20, 1904. Mr. Harrington married (second) July 18, 1906, Jeanne Ethlyn Smith. By his first wife he had children as follows: 1. Harriet Elizabeth, born July 10, 1857; married, February 14, 1889, Madison F. Larkin; child, William Stark, born November 2, 1889, died same day. 2. Carrie Estelle, born December 27, 1858; married (first) June 1, 1886, Charles W. Reichard; child, David Carl, born August 3, 1892, married, January 26, 1910, Marie A. Schatt; one child, David Carl Jr., born December 28, 1911; Carrie Estelle married (second) June 3, 1911, Samuel Porter

Lummus. 3. Lillian Jannette, born September 15, 1800, died July 17, 1898; married, January 13, 1886, William L. Cornell; children: i. Jessie English, born November 18, 1886, married, September 29, 1908, George Houck; one child, William L. Cornell Houck, born July 14, 1913. ii. Natalie Grant, born December 19, 1888, married, January 8, 1910, Rudolph Senn Houck; children: Ruolph Senn Houck Jr., born March 27, 1911, and Lillian Jannette Houck, born July 18, 1912. iii. Lillian Jannette, born July 29, 1892. iv. Blandina Harrington, born September 7, 1895, died May 1, 1907. 4. Blandina Jayne, born November 8, 1862; married, March 4, 1896, Thomas Jefferson Foster; child, Thomas Jefferson Jr., born October 4, 1900. 5. Walter Eugene, born June 3, 1866; married, November 8, 1888, Maude Hastings; children: Leigh Walter, born September 17, 1889, and Kenneth Connell, born November 22, 1892, died July 24, 1893. 6. Curtis James, born April 21, 1870, died September 10, 1904; married, June 6, 1891, Helen Bernadon; child, Curtis James Jr., born February 27, 1892, afterwards adopted by Madison F. and Harriet E. Larkin, and his name changed to Curtis Harrington Larkin. 7. Frederick Andrew, born March 8, 1872; married, April 3, 1895, May E. Worthington; child, William Lawrence Connell, born November 24, 1897. 8. Dora, born March 11, 1874; married, October 6, 1898, Christian Paul Hagenlocher. 9. Ethel, born February 25, 1877; married as his second wife, November 29, 1899, William Lawrence Connell, her brother-in-law; children: William Lawrence Jr., born June 30, 1901; David Harrington, born November 16, 1902, died May 21, 1907; Ethel Chase, born March 21, 1905, died February 14, 1907. 10. Mabel, born January 16, 1879, died July 5, 1879.

In 1887-88 Mr. Harrington made two trips to the City of Mexico on professional business, and while there he learned to speak the Spanish language. Since that time he has lectured on his trips. In 1867 he compiled, collated, arranged and published "The Rules of the Luzerne County Court," an exhaustive volume of eighty-one pages octavo. He has also written many briefs which have gone into print and some of them have been widely circulated. Among the more important of his treatises is one on "Commerce and What is Doing Business, under the Statutes of the United States Relating to Foreign Corporations," "The Education of Minors," "Ordinances, Affecting Circular Distribution and Advertising," and on "Law and Facts." During a part of the time he resided in Wilkes-Barre, he reported court proceedings and local items of news for a paper published in Scranton, and for another published in Wilkes-Barre.

---

#### HON. HENRY ALONZO KNAPP

Hon. Henry Alonzo Knapp, who ranks among the successful and influential members of the Scranton bar, was born July 24, 1851, in the town of Barker, Broome county, New York, the son of Peter and Cornelia Eveline (Nash) Knapp, both natives of the Empire State, the former a successful farmer and prominent citizen. Peter Knapp was the son of Henry and Anne (Harris) Knapp, who came to Broome county from Dutchess county in the same state in 1817. On his mother's side Henry A. Knapp is the grandson of Rufus Nash, a native of Connecticut, who emigrated to New York in 1820, and Rufus was a lineal descendant in the sixth generation from Edward Nash, who came from England about 1650 and became one of the founders of Norwalk, Connecticut.

The boyhood life of Henry A. Knapp was somewhat varied; he left the farm at the early age of nine years and for the most part for several years thereafter made his home with his uncle, S. M. Nash, who in 1860 was conduc-

tor of one of the two passenger trains on the Lackawanna Railroad, and Henry A. Knapp very early started on a business career by selling newspapers and other commodities on the train. Later he attended the Binghamton Academy, and in 1873 began the study of law with Judge Handley at Scranton.

Entering the bar in 1875 he formed a partnership with Edward Merrifield, Esq., under the firm name of Merrifield & Knapp, and continued that relation several years, and then carried on practice in his own name until 1892, with the exception of one year when he served as a judge of the several courts of Lackawanna county, by appointment of Governor Beaver. In 1892 he formed a law partnership with Hon. E. N. Willard and Everett Warren, Esq., under the title of Willard, Warren & Knapp, which has continued to the present time, except that during the time Judge Willard was on the bench of the superior court the firm name was Warren & Knapp. From 1890 to 1900 Judge Knapp was county solicitor of Lackawanna county, and from 1889 to 1898 he was also solicitor of the Scranton school district. The firm of which he is a member is the counsel of many corporations and his practice in recent years has been mostly taken up with corporation matters, largely in consultation and office work, although occasionally in the trial of cases in the common pleas. Judge Knapp has had a leading part in various business enterprises, and in matters of public interest has been prominent and conspicuous.

In 1877 he was a leading spirit in the organization of Company "A," one of the four military companies recruited during the labor troubles of that year, and was chosen first lieutenant of the company and a year later succeeded Captain Bryson as captain. Later he was appointed judge advocate on the staff of General Gobin with rank of major. He was connected with the National Guard until his appointment to the bench in 1887, when he resigned. For nearly twenty-five years past he has been chairman of the advisory board of the Home for the Friendless; for several years he has been a director of the Board of Associated Charities; he is also a director of the Scranton Hospital for the Cure of Consumptives, and his legal services have been sought and freely extended to these and other charitable institutions, who have found in him a valued and useful friend. He is vice-president and a director in the Title Guaranty and Trust Company and also interested in other prominent institutions.

In 1883 Judge Knapp married Lillie Logan, of Scranton, and they have one daughter, Alice Alden. Mrs. Knapp is a lineal descendant of John Alden, of Colonial fame.

---

#### WALTER WINTHROP WINTON

Pennsylvania is indebted first to Old England and then to New England for the Wintons, a name represented in the earliest history and development of Scranton. Of Quaker ancestry, the emigrant came to Connecticut from England and settled on the Naugatuck river. From this region Andrew Jackson Winton, grandfather of Walter W. Winton, of this narrative, enlisted in the American army at the beginning of hostilities with England in 1812, and at the conclusion of that conflict in 1814, he settled at Butternut, Otsego county, New York. Because of the lack of transportation facilities in that section of the state, he and his brother established and conducted a stage coach line between Albany and New York, a public accommodation much appreciated and heavily patronized.

(11) William Wilander Winton, son of Andrew Jackson Winton, was born in Butternut, Otsego county, New York, where he lived until he was about twenty years of age, engaging, after he had obtained his education, in the peda-



gical profession, at the same time continuing his own studies in Latin and legal branches. Coming to Scranton he secured employment in the store of his father-in-law, Harry Heermans, one of the first merchants to establish a business in what is now Scranton. Harry Heermans came to this locality from Salem, the journey being made in wagons, containing besides his household effects his stock of household commodities, groceries and other articles necessary to the families of the region. Every store at that time was of necessity a general supply centre, whose departments covered all the varied needs of the small communities, from food for man to harness for beast.

While employed by his father-in-law, William W. Winton continued his legal studies, his wife teaching school in the vicinity, and while he was never admitted to the bar he gained a sufficient knowledge of business, law and processes to enable him to become executor of his father-in-law's estate. He was largely instrumental in opening one of the first coal mines of the region, the vein followed extending under the old "Bell school-house." The death of his father-in-law left the mercantile field open for new concerns, and Mr. Winton, in partnership with A. B. Dunning, his brother-in-law, opened a store in Providence, Pennsylvania. He soon moved to New York City and was engaged in the wholesale hat, cap and fur business for a period of fifteen years, his establishment being on Cortlandt street. The business training he received in the metropolis opened his eyes to the possibilities of his former field of endeavor and he returned to Providence, where he organized the New York and Pennsylvania Coal Company, the second in the North End. Thus attracted by the opportunities opened to a capable and trusted financier, he opened a private bank, under the name of Winton & Company, bankers. This enterprise met with popular favor and did a large and prosperous business. During the years of the Civil War he played a prominent part in the organization of the Second National Bank of Scranton and a few years later performed the same service for the First National Bank, of Providence, two institutions which were later merged under the name of the former. He was also the organizer and became president of the Winton Coal Company, whose mines were located at Winton, Pennsylvania, a town named in honor of the company. Mr. Winton's death occurred on December 30, 1894, closing a life of useful activity and successful endeavor, the reward of years of constant, energetic and well directed battling at the walls of achievement. He married Catharine Heermans, oldest daughter of Harry Heermans.

(III) Walter Winthrop Winton, son of William Wilander Winton, was born in Providence, Pennsylvania, June 3, 1845. After obtaining a public school education, including a high school course, he entered the law school at Harvard. This was the result of his father's desire, as the elder Mr. Winton had earnestly wished for a college legal education, and disappointed in this, had made it his ambition that the opportunities denied him should be accorded to his son. Walter W. Winton, however, did not care enough for the profession to make it his life work, and going to New York he engaged in the wholesale diamond and jewelry business. In this field he prospered, becoming an expert in detecting the flaws in precious gems and distinguishing between imitation and genuine stones. In order to become more closely acquainted with the production of diamonds in which he dealt extensively, he visited the world famous mines at Kimberley, Cape Colony, South America, in 1879, whence comes ninety-eight per cent. of the entire diamond output of the world. He here familiarized himself with every detail in the mining of these stones, thus completing his knowledge of the route followed by the jewels from their resting place in the rocks, where they were formed by some vast cataclysm of nature, to the dainty ears or shapely fingers of their final

purchasers in the large cities of the world. Upon his return from South Africa, he settled in Scranton, where he opened a retail diamond establishment, attracting a wealthy and influential trade among the best people of the city. He became connected with the Winton Coal Company soon after his arrival in Scranton and is now president of that concern. While Mr. Winton is a strong supporter of the Republican party, his interest in office holding is confined to advancing the cause of some worthy candidate, always refusing public preference for himself. He has attained the thirty-second degree in Ancient and Accepted Scottish Masonry.

Mr. Winton married Mary Blakey, daughter of William Blakey, of Orange, New York, and has one son, Walter Winthrop Jr. Of Mr. Winton's relation to Scranton affairs it may be said that he is in no way failing the expectations of those who judged his capacity for achievement from the record of his honored father, and that in him the ancient family name finds a most worthy bearer.

---

### JOHN T. RICHARDS

At the time when the mines in the vicinity of Scranton were being opened and operations commenced upon a large scale, there was a large number of Welsh miners who left their positions in their native land and made their homes in this locality, the reason for the influx of immigrants being that wages for labor in the newly opened mines were much higher than in Wales. It was this tide of settlers that carried Thomas Richards to Carbondale in 1833, although his trade was that of shoemaker, not of miner. In the following of his occupation throughout his exceptionally long life he acquired a competence that enabled him and his wife to spend their later years in quiet and comfort, both dying in 1900, both aged eighty-eight years. It was a happy coincidence that two lives spent together in congenial and blessed companionship should be reunited so soon after their first separation.

John T. Richards, son of Thomas and Margaret (Morgans) Richards, was born in Carbondale, Lackawanna county, Pennsylvania, September 15, 1853. He obtained his early education in the place of his birth, later attending the public schools of Scranton, and when nineteen years of age entered the Merchants and Mechanics Bank as errand boy. Although his early employment was assuredly humble, he performed all of his duties with a quick and willing cheerfulness that won him instant favor and as rapidly as openings appeared above him he was placed therein. In each position the same assiduous attention to business and a marked capacity for hard work was observed by his superiors and four years after his first appearance in the bank he was appointed cashier. This office he filled with strict fidelity and proven ability until 1894, when he resigned to engage in wider fields of business. At the organization of the Alexander Car Replacer Manufacturing Company in 1894 he became secretary and treasurer. The responsibility of the position is apparent when the capitalization of the company, \$100,000, is known. The original officers of the concern were: Joseph J. Jermyn, president, John A. Mears, vice-president, and John T. Richards, secretary and treasurer. The present organization is J. F. Mears, president, G. Bogart, vice-president, John T. Richards, secretary and treasurer. The Alexander Car Replacer Manufacturing Company is a flourishing concern, their appliance being in use on most of the railroads in the United States, Canada, South America, Australia, China, Japan, Europe, and the British Isles. Its use has also been adopted in coal mines using electricity. In addition to his duties as secretary of this company, Mr. Richards, in 1895, became executor of the estate of Judge John





Henry Schmidt

Handley. He has also been actively concerned in coal operations in the vicinity for many years.

Mr. Richards has always taken great interest in local affairs and at one time was a member of the Scranton select council, where he was numbered among the most progressive of the body, always championing any measure that he believed for the true good of the municipality and as stoutly opposing those originated for private gain or for the furtherance of selfish purposes. He is past master of Hyde Park Lodge, No. 339, F. and A. M.

Mr. Richards married Josephine, daughter of Joseph Chase, of Scranton, and has one daughter, Margaret Louise. Mr. Richards' office is in the Mears Building. In his business relations he has shown marked ability as a financier, and as a public spirited and progressive member of the community is ever enrolled among those who are working for the advancement of the city's interests.

---

### HENRY BELIN JR

Although prominent in the manufacture of explosives used in time of war with deadly effect, Mr. Belin is not a destroyer, but a constructor and most humane and liberal in his dealings with his fellow men. In fact his labors in the cause of afflicted humanity have been so beneficial, and far reaching that the term "philanthropist" is not misapplied in his case.

The Belins are of French descent, the first of the name known in America being John Belin, great-grandfather of Henry Belin Jr., of Scranton. He was a planter on the Island of San Domingo, West Indies. His son, Augustus Belin, succeeded him, but in the uprising of the blacks in 1791, he was compelled to flee for safety. He came to the United States, first engaging in business in Philadelphia, later moving to Wilmington, Delaware, where he formed connection with the famous DuPont Powder Works.

He married Alletta Hedrick, of Philadelphia, born of Danish parentage. Augustus Belin died in Wilmington in 1843, aged seventy-three years, leaving children: Ann, Henry and Charles.

Henry (1) Belin was born in Philadelphia, died in Wilmington, Delaware, in 1891. After a thorough preparation, he was awarded a cadetship at the West Point United States Military Academy, where he was graduated, and joined the newly formed corps of Topographical Engineers, and remained with that corps until 1843, being connected during that time with various important surveys conducted by the government. Resigning from the army in 1843, he formed a connection with the DuPont Powder Works at Wilmington, a company with which he was identified until 1865, when he moved to St. Louis, Missouri, engaging in business there for ten years. He then returned to Wilmington, which was his home until death.

He married, Isabella, daughter of Henry d'Andelot. She died in 1863, aged fifty years, leaving children: Gratiot, d'Andelot, died in infancy, Louisa, Mary, Henry Jr., of whom further.

Henry Belin Jr. was born September 23, 1843, at West Point, New York, his father being then stationed at the military academy. He prepared for college at Hopkins grammar school, New Haven, then entered Yale University, whence he was graduated A. B., class of 1863. He began his business life with the house with which his father and grandfather had been identified, the E. I. DuPont de Nemours and Company, powder manufacturers, and is now the president of the Pennsylvania corporation, known over the world. For seven years Mr. Belin made his home in Wilmington, but in 1870 he moved to Scranton, Pennsylvania, which city has ever since been

his home. In addition to his connection as head of the E. I. DuPont de Nemours & Company of Pennsylvania, Mr. Belin is director of the First National Bank of Scranton, vice-president and director of the Cherry River Boom and Lumber Company, vice-president and director of the Scranton Lace Company, director of the Lackawanna Trust and Safe Deposit Company, director of the Hebard Cypress Company, and interested in other of the business enterprises of Scranton, where he is rated a leading factor in the development of the business interests of that city and section.

Prominent as is the position Mr. Belin occupies in the world of finance and industry, he is ever the interested citizen and humanitarian, his sympathy and benevolences being freely bestowed upon every worthy object. He was in the service of his state for several years, serving in the Thirteenth Regiment Pennsylvania National Guard for two years, and for one year as aide de camp on the staff of Brigadier General Sigfried. In political faith he is a Democrat, and in religious preference is identified with the Second Presbyterian Church, which he serves as trustee.

In philanthropic work for the amelioration of the conditions surrounding the afflicted, he has ever shown interest, sympathy and liberality. He was identified with all the movements resulting in the establishment of the Pennsylvania Oral School for the Deaf, was one of the charter founders and has served from the first on the board of trustees as treasurer. The demands of the Hahnemann Hospital have also been recognized, he having long been a member of its advisory board. He is also a trustee and treasurer of Scranton Public Library and a member of the Pennsylvania State Library Commission. Thus Mr. Belin has demonstrated his true manhood, and in all his activities displayed the characteristics, marking the best type of American manhood. Modest and retiring in disposition, he is forceful and practical in reality and while his highest ambition is to be useful to his fellow men in the truest sense, he has never sought or accepted public office.

Mr. Belin married Margaretta, daughter of Ferdinand LaMotte, of Wilmington, Delaware. Children: May, married Nathaniel Robertson, of Scranton; Alice, Paul B., Charles, F. Lamnot, Margaretta, d'Andelot.

---

#### PAUL B. BELIN

The city of Scranton became the home of Henry (2) Belin, president of E. I. DuPont de Nemours Company in 1871, and is still the seat of his activity. Here were born his two sons, Paul and F. Lamnot, who have firmly established themselves in the business world as worthy sons of their honored father.

Paul B. Belin was born in Scranton, Pennsylvania, July 26, 1875. He attended the city schools, then entered Yale University, whence he was graduated, class of 1895. He then took a post-graduate course at Columbia University in architecture, following the profession of an architect for several years. In 1898 he became treasurer and general manager of the Scranton Lace Curtain Company, one of Scranton's important industrial enterprises, with which he yet holds the same official position. He is also a director of the Lackawanna Trust and Safe Deposit Company and interested in other business concerns. In business circles his standing is of the highest, while in his official positions he is efficient and most practically useful. He is a member of the Engineers' Club of Northeastern Pennsylvania and of the Scranton Club. Mr. Belin married Lucie, daughter of Charles H. Welles, an eminent attorney of Scranton. Children: Henry (3) and Charles Welles Belin.

## F. LAMMOT BELIN

In the person of Mr. Belin, the fourth generation of Belins occupies important position in the great DuPont Powder Manufacturing Company. F. Lammot Belin was born in Scranton, March 15, 1881, son of Henry (2) Belin whose own and family history is also recorded in this work.

After completing his preparatory courses in the Lackawanna and Hotchkiss Schools, F. Lammot Belin entered Yale University, whence he was graduated Ph.B., class of 1901. Returning to Scranton after graduation he was associated with the Scranton Lace Curtain Company for three years. He then formed a connection with E. I. DuPont de Nemours & Company, of Pennsylvania, and is now vice-president of that company, his honored father being president. Mr. Belin Jr. is also a director of the Traders National Bank and of the Wyoming Shovel Works. Though comparatively young in the business world he has met successfully every demand made upon him and ranks as one of Scranton's capable men of affairs.

He has taken active part in city affairs as a member of the Council to which he was appointed in the first instance and elected by the people in 1911. He is an efficient, active official and takes a leading part in city legislation. He is a member of the Scranton Club and the Scranton Country Club.

Mr. Belin married, January 17, 1912, Frances, daughter of Frank H. Jermyn, of Scranton. He has a son, F. Lammot (2).

---

CHARLES P. SAVAGE

Having sprung from the purest of English stock, the Savage family of Dunmore, Lackawanna county, while retaining all of a descendant's pride in a mother country, has become so thoroughly imbued with American thought and spirit that to its foster mother falls the benefit of its services and the credit for duty well done.

(I) Joseph Savage, grandfather of Charles P. Savage, in 1850 came to the United States from his home in Bath, England. A far sighted, prophetic visioned Englishman, he predicted the future of Dunmore and Scranton to a degree and, desiring his sons to share in the growth and upbuilding of such a community, there made his home, although the hamlet of 1850 gave to the person of ordinary perception no promise of the city of the present. Here Joseph Savage became engaged in the development of the mining industry in the capacity of mining engineer, and directed work on some of the earliest operations in that locality, continuing in active pursuance of his calling until his death.

(II) Robert P. Savage, son of Joseph Savage, was born in Bath, England, in 1834, died in Dunmore, Pennsylvania, in March, 1912. When his parents immigrated to Scranton he was but sixteen years of age, and when but a young man he learned the carriage building and blacksmith's trade. He established the first carriage building manufactory in Dunmore and for a long time was engaged in the making of carriages. He took a prominent part in the affairs of the borough and for several years served as burgess, also being a member of the town council. His only fraternal connection was with the Masonic order, in which he belonged to Peter Williamson Lodge, F. and A. M. Both he and his wife were communicants of the Presbyterian church. He married Sarah Elizabeth, daughter of Charles Wesley Potter. Children: Cora E., married Brevard E. Harris, of Concord, North Carolina; Charles P., of further mention; Maude, married E. D. Ames, of Dunmore.

The Potter family, which joined the Savage family by the marriage of

Robert P. and Sarah Elizabeth (Potter) Savage, was first planted in Pennsylvania by Elisha Sweet Potter, who came from Connecticut on horseback, settling on a farm in Providence. He was the father of Charles Wesley Potter, died in 1857, aged forty-two years. Charles Wesley Potter was born on the Potter farm, now the property of the Delaware and Hudson, and moving to Dunmore was there one of the first settlers. He conducted extensive dealings in real estate, also engaging in farming and was justice of the peace. He married Sarah Ann Eakin, a native of Martin's Creek, Pennsylvania.

(III) Charles P. Savage, son of Robert P. and Sarah Elizabeth (Potter) Savage, was born in Dunmore, Pennsylvania, November 28, 1862. He obtained his education by attendance at the public schools of Dunmore and at "Daddy" Merrill's academy in Scranton. His first employment was with the Pennsylvania Coal Company, his immediate superior being John B. Smith. He here learned telegraphy and became the company's operator. During his stay in the employ of this corporation he had held the office of secretary and treasurer of the Dunmore Gas and Water Company for several years. He remained in the coal business until his entrance into political service in 1901, during which time he was purchasing agent for the Pennsylvania Coal Company, the Dunmore Iron and Steel Company and the Erie and Wyoming Valley Railroad Company, all three of which companies were under one control. In 1901 he accepted a clerkship under County Controller E. A. Jones, who assumed the reins of office on July 1, 1901, and has been connected with the county controller's office ever since as chief clerk, deputy, and finally as controller, the latter by appointment of the governor to fill out the unexpired term of Mr. Jones, whose resignation, on October 4, 1911, left the position vacant. The choice of the chief executive of the state was confirmed by the people of the county in November, 1911, when Mr. Savage was elected county controller for a four year term. All of his political triumphs have been as the nominee of the Republican party. During his Dunmore residence he was for nine years clerk of the borough council. Mr. Savage is secretary and director of the Fidelity Deposit and Discount Bank, of Dunmore. He is also secretary and treasurer of the Delaware and Hudson and Pennsylvania Coal Companies' Gravity Employees Association, an organization for purely social purposes, composed of the old employees of the corporations, which have relinquished their charters and have ceased to exist in their corporate form.

He is a member of the Masonic order, belonging to King Solomon Lodge, Free and Accepted Masons, of Dunmore, in which he is past master; he is also past grand of Dunmore Lodge, No. 816, I. O. O. F.; belongs to Dunmore Lodge, No. 167, K. of P.; Dunmore Camp, No. 10,270, M. W. of A.; Dunmore Lodge, Improved Order of Heptasophs. He is a member of the Presbyterian church, and takes a great interest in its affairs, having been secretary of the board of trustees for twelve years. As controller of the county finances, Mr. Savage has been uniformly careful and accurate in his guard of the public funds. Honorable, straight-forward and reliable, the people have found in him a servant worthy of the highest trust.

---

#### FRANK H. CONNELL

William P. Connell, father of Frank H. Connell, of this narrative, was a native of Philadelphia, where his father had been a member of the firm of Lovejoy & Connell, manufacturers of pewterware. William P. Connell learned the practical side of this business, and in 1855 came to Scranton, where in partnership with Henry B. Rockwell he opened a hardware store, under the firm name of Rockwell & Connell. Both being young men of energy and ac-



tion they did not sit passively by and wait for trade from the surrounding neighborhood to seek them out, but instituted the innovation of covering the territory by means of wagons, conveying a complete, though necessarily small, stock of the different articles handled at the store. This system, inaugurated in an unpretentious manner, met with popular favor and was enlarged until the force so employed numbered between sixty and eighty men. Emboldened by the success of this undertaking, the firm branched out in a new department, plumbing, the amount of work done in that line soon eclipsing that of the hardware store. Mr. Connell continued in that business until his death, which occurred in 1899, aged sixty-six years. He was a member of the First Presbyterian Church, devout in the performance of religious duties. His political faith was Republican and he was for a time a member of the city council. He was a thirty-second degree Mason, belonging to Coeur de Lion Commandery, Knights Templar.

William P. Connell married Alida Van Buren, daughter of House Hurd, a native of Kinderhook, New York. Frank H., of further mention, is the only one of the children living. Frederick, the oldest son, a graduate of Yale University, and a member of the bar of Lackawanna county, died in 1919, aged fifty years. Mr. Connell's home in Scranton for many years was on the site now occupied by the People's Bank Building.

Frank H. Connell, son of William P. and Alida Van Buren (Hurd) Connell, was born in Scranton, Pennsylvania, November 15, 1862. He obtained an excellent education in the public schools, later attending Kingston Academy and Lawrenceville Preparatory School. Although ably fitted for college, he decided upon a business career and for over twenty years was in the employ of his father. He left his position with his father's firm to become secretary and treasurer of the Seybolt Milling Company, and was identified with that company for several years, later becoming connected with the Pennsylvania Casualty Company, which was merged with the Massachusetts Bonding and Insurance Company, the name of the latter being retained. Mr. Connell's position with this corporation is as manager. He here finds a wide field for the exercise of acutely trained business instincts, inherited from a resourceful and progressive sire, and controls the investments and dealings of the company with results most gratifying to its officials. He holds true to a course of the strictest integrity in his business life, seeking only to acquire that which may be obtained legitimately and thus gaining the confidence and trust of business associates and the regard and respect of friends. His only social connection is with the Scranton Club, and his religious affiliation is with the Second Presbyterian Church. He married Frances S., daughter of Calvin Seybolt, of Scranton. They are the parents of one daughter, Helen.

---

#### FRANK CAUM

Edward L. Caum, father of Frank Caum, of this narrative, was born in Camden, New Jersey. He spent nearly his entire life in the service of the Pennsylvania Railroad, as master mechanic, first at Mifflin, and from 1869 until his death in 1912, aged seventy-nine years, in Harrisburg, whither the shops were moved in the former year. He was a member of the Masonic Order. He married Ellen Wright.

Frank Caum, son of Edward L. and Ellen (Wright) Caum, was born in Juniata county, Pennsylvania, January 4, 1865. He attended the public schools, and as a young man began a connection with railroads and transportation companies that has continued until the present time, although that period has been spent in the employ of many different roads. He served his apprentice-

ship in the trade of machinist in the shops of the Pennsylvania Railroad. He followed that occupation for seven years in Harrisburg, then going to Meriden, Connecticut, where he remained for one year, at the expiration of that time entering the employ of the Meriden Waterbury and Connecticut River Railroad. He severed that connection to accept a position in the car barns of the Rochester Railroad, whose service he entered in 1890. He received a promotion to the position of engineer in the power station, but after a year had passed, resigned and took a position with the Ball and Wood Engine Company, of Elizabethport, New Jersey, and not finding this to his liking, after a few months returned to Rochester, continuing in his former capacity for another year. In the latter part of 1892 he became chief engineer of the power station of the Jersey City and Bergen road, a position he held until June, 1894. While with this road he was for a short time engaged in the building of a road in New Jersey. In August of the same year he was engaged as chief engineer of the power station of the Hartford Street Railway. In 1897 he was promoted to the superintendency, and in 1905 he became manager. The year after his elevation to that position he came to Scranton as general manager of the Scranton Railway Company. While Mr. Caum has in a sense been a rolling stone, as a stone he has possessed the qualities of a ball of snow, which when set in motion constantly becomes larger and a more perfect specimen of a snow ball than before it was moved. So in his restless, nomadic wandering, Mr. Caum has gathered, not moss, but an invaluable knowledge of methods used in transportation, and a thorough insight into the workings of every department of a railway system. It is that technical knowledge that has made him so indispensable to the Scranton Railroad Company, whose affairs he directs from a perfect understanding of the entire system. Himself a trained mechanic and one who has seen active service in the lower grades of the employment, he knows just the amount of work of which each man is capable, and in fair-minded justice expects him to do no more. He is the type of employer in whom a faithful and conscientious workman delights, but a veritable thorn in the flesh to the shirking drone, who does as little as necessary in as long a time as possible. Mr. Caum is a member of the board of directors of the Anthracite Trust Company.

Mr. Caum married Louise, daughter of Irvin Crane, of Harrisburg, Pennsylvania, and they have one son, Norman C. It was a pleasing tribute to the excellent impression made by Mr. Caum that during the years when his life was so unsettled he could always return to the position he had just left. He regards each situation as but a stepping-stone to another, and all but a training for a more important and more responsible position in the business he has made his life work.

---

#### LUTHER KELLER

Luther Keller, a well known business man of Scranton, Pennsylvania, is a member of a family whose history is of more than ordinary interest.

(1) Joseph Keller, the emigrant ancestor of this family, was born in Schwarzenacker, near Zweibruecken, Bavaria, Germany, March 15, 1710. His mother had been twice married, according to family tradition, her first husband being a Mr. Guth, and a son of this marriage had come to America, as had also her elder son of the second marriage. Joseph Keller sailed on the ship William, for America, and arrived at Philadelphia, October 31, 1737. He lived with the family of his step-brother, — Guth, and nearby lived Mary Engel Drumm, who later married Mr. Keller, with whom she had grown up. They married about 1742, and settled in Northampton county, Pennsylvania.

They were called upon to endure all the hardships of the early settlers, among these being the capture by Indians of Mrs. Keller and several of her children and the murder of the eldest child. They were taken by the Indians to Canada and handed over to the officers of the French army. They were held captives until three years later when the English army defeated the French at Ottawa and set free all prisoners held by the French. Mrs. Keller with her children made their way back to their home, over 1000 miles, and were again united. The children of this family were: 1. Christian, born September 10, 1743; murdered by the Indians at the age of fourteen years. 2. Anna Margaret, born March 15, 1745; married a Mr. Miller, and had a daughter Elizabeth. 3. Henry Adam, born January 1, 1747, died in young manhood. 4. Simon, born October 29, 1749; married a Miss Dipper, and had three children. 5. Joseph, of further mention. 6. John Jacob, born July 10, 1754, was captured by the Indians when a little more than two years old, and never heard from again. 7. John Jacob, second of the name, was born March 22, 1757; married Maria Dorothy Metz, and had children; later removed to Ohio. 8. Philip, born March 29, 1763; married (first) Sarah, daughter of Henry Miller, (second) Widow Susannah Engler, and had children by both marriages.

(II) Joseph (2) Keller, son of Joseph (1) and Mary Engel (Drumm) Keller, was born January 15, 1751, died April 15, 1832. He was almost six years old when with his mother was captured by the Indians, and about nine years of age when returned to his home. He enlisted as a "Seven-Months Man" at the time of the Revolutionary War, but the length of his service in the Continental army is not known. After his marriage he removed to Cherry Valley. He married Maria Magdalene Andre, born June 15, 1785, died September 6, 1831, daughter of Leonard Andre. They had children: 1. Adam, married Elizabeth Fisher and had children; lived in Upper Mount Bethel township. 2. Leonard, a blacksmith; married and had children. 3. Joseph, married (first) a Miss Riegel, (second) an English woman and had children by both marriages; moved to the west. 4. Jacob, married Nancy Dennis and had children; lived in Briar Creek Valley, Columbia county, Pennsylvania. 5. John, married Mary Johnson and had children. 6. Henry, married a Miss Hess; moved to Columbia county. 7. Elizabeth, married John Fellenser, had five children, all deceased. 8. Mary, born 1780, died June 4, 1842; married Henry Algert and had children. 9. Peter, of further mention. 10. Sarah, married Robert Shaw; moved to Illinois. 11. George, born January 15, 1797, died February 3, 1871; married (first) Mary Bitja, born December 15, 1803, died October 1, 1825; married (second) Lovina Lern, born March 11, 1807, died August 17, 1872; had children by both marriages.

(III) Peter Keller, son of Joseph (2) and Maria Magdalene (Andre) Keller, was born August 26, 1794, died September 20, 1878. He grew to manhood in Cherry Valley, Northampton county, Pennsylvania, now Monroe county, where he became a prosperous farmer and mill owner, also running a line of freight teams from that section to and from Easton, Stroudsburg and Philadelphia, before the era of railroads. He was a Whig in early life, and upon the organization of the Republican party joined its rank, and was a very prominent citizen. Mr. Keller married Elizabeth Heller, born October 19, 1798, died November 23, 1886. They had children: 1. John, born October 11, 1818, died April 3, 1886. 2. Susan, born January 2, 1821, died March 2, 1883. 3. Catharine, born in 1822; married Thomas W. Rhodes and had one son, Stewart T. 4. Daniel, of further mention. 5. Charles, born April 20, 1827; married Lavine Smith, born February 7, 1827, died June 22, 1897; had children. 6. Mary Ann, born November 29, 1829; married Henry Dennis, born January 11, 1830, died October 10, 1901; had children. 7. Joseph J.

born October 18, 1832, died December 11, 1871; married Mary J. Rhoads; had six children. 8. Lewis, born in 1833, died September 11, 1903; married Julia Werkheiser. 9. Louise, born in 1833. 10. Sarah, born in 1835. 11. William, born in 1837; married Sarah Kemmerer, born February 9, 1834; had children. 12. Theodore, born in 1837.

(IV) Daniel Keller, son of Peter and Elizabeth (Heller) Keller, was born in Monroe county, Pennsylvania, in April, 1825, died February 8, 1904. He learned the trade of milling in the grist mill of his father, and succeeded the latter in the conduct of this business, continuing in it, to the exclusion of other business interests, until several years prior to his death, when he had retired. He was a Republican in politics, and a member of the German Reformed Church. He married Catherine Jane Drake, born April 20, 1828, died March 27, 1861, daughter of Wayne Drake, a prosperous farmer of Monroe county, Pennsylvania. Four children grew to years of maturity: 1. Luther, of further mention. 2. Morris T., of Scranton. 3. Laura, married James Decker, of Monroe county, Pennsylvania. 4. Isabelle, married S. B. Decker, of Monroe county, Pennsylvania.

(V) Luther Keller, eldest son of Daniel and Catherine Jane (Drake) Keller, was born near Stroudsburg, Pennsylvania, October 27, 1850. He remained at home until he was twelve years of age, at which time his mother died. He then left the home farm to make his own way in the world, in which he succeeded without other assistance than his perseverance, and willingness to work. He secured a position on a farm where he worked summers and attended school winters until he was fifteen years of age. He then came to Scranton, where for four years he worked with Lewis and Sidney Keller, who taught him the trade of harness making. During this period he attended the night classes at Gardner's Business College, gaining a clear knowledge of business forms of procedure. In 1875 he established his present place of business, the wholesale and retail lime and cement yard, in Scranton. He began in a small way, but prospered from the beginning to such an extent that soon afterward he leased the lime works at Portland which he subsequently purchased, and at the present time is operating an additional quarry, making it the largest plant of this kind in eastern Pennsylvania, and employing a large force of men. The product is sold in New Jersey, Eastern Pennsylvania and New York State. To this lime business he has added cement, hard wall plaster, sewer pipe, fire brick and clay, and in fact conducts a complete builders' supply house. Mr. Keller's office and yards are at Nos. 813-815 West Lackawanna avenue, Scranton, Pennsylvania. He conducts a large and prosperous business, as manufacturer, wholesaler and retailer, holding the confidence of his many customers and of the world of business in which he moves. His success in life has been the result of his own energy, integrity and upright business principles, strictly adhered to in every transaction. He had aided in the establishment of many, now prosperous, Scranton industries, in fact, few new enterprises have been established here during the past twenty years in which he has not taken an active interest. He has worked personally in this direction as a persistent advocate of Scranton's desirability as a manufacturing center, and through the board of trade, of which body he was president two years, and vice-president five years. In addition to his private business he has been director of the Third National Bank for twenty years; is vice-president of the Scranton Textile Company, and interested in other Scranton enterprises. Scranton has no truer friend or one who more earnestly labors for the well being of the community. For fourteen years he was a member of the city council, its president for two years, and in that capacity used his best efforts to promote the public good. He was made a Mason in 1877, and is now a



*Very truly  
Yours*



member of Union Lodge, Lackawanna Chapter, Coeur de Lion Commandery, Irem Temple and Keystone Consistory, in which he has attained the thirty-second degree.

In the church of his choice Mr. Keller has been and is most useful. Since 1868 he has been a member of what is now the Immanuel Baptist Church, formerly the Penn Avenue Baptist Church, for twenty-five years has been superintendent of the Sunday school, also president of the board of trustees and deacon for many years. He is widely known in the church outside of Immanuel, was moderator of Abington Baptist Association, two years; president of the Baptist State Convention, two years; and is now a member of the executive committee of the Northern Baptist Convention, and is a charter member of the Ministers and Missionary Benefit Board of the Northern Baptist Convention. Mrs. Keller is a co-worker in the church, taking an active part in the women's organizations. The family home is at No. 515 Clay avenue.

Mr. Keller married (first) September 18, 1879, Annie E. Halstead, who died February 18, 1883, daughter of Nathaniel Halstead. There were no children by this marriage. He married (second) January 21, 1886, Laura F. Frey, daughter of Peter and Maria (Boyer) Frey, of Portland, Pennsylvania, and the children of this marriage now living are: Ruth, born in 1892; Russell, born in 1899.

---

#### EZRA H. RIPPLE JR.

Ezra H. Ripple Jr., only son of Colonel Ezra H. and Sarah H. (Hackett) Ripple, was born in Scranton, Pennsylvania, January 31, 1879. His early education was obtained in the public schools, followed by a course at the University School, at Cleveland, Ohio, and at Pennsylvania Military College at Chester, Pennsylvania. He was graduated from the latter institution, class of 1898. He then enlisted in the Thirteenth Regiment Pennsylvania Infantry, for service during the Spanish-American War, serving until March, 1899. He then was engaged as mine surveyor until 1900, when deciding upon the profession of law he registered as a student of Welles & Torrey, then entered the law department of the University of Pennsylvania, whence he was graduated LL.B., class of 1904, being admitted to the Lackawanna bar at the March term 1905. He has since that date practiced his profession in Scranton in association with H. C. Reynolds. He has been admitted to all state and federal courts of the district, has a large practice, and in September, 1911, was appointed referee in bankruptcy. Mr. Ripple enlisted in Company D, Thirteenth Regiment, National Guard Pennsylvania, as private, June 8, 1899, and has received the following commissions in the regiment: November 8, 1899, second lieutenant; May 14, 1900, first lieutenant; August 25, 1903, captain; June 28, 1907, major; September 25, 1908, lieutenant-colonel, his present rank in the Thirteenth (1914). His college fraternities are: Phi Gamma Delta and Delta Chi. In religious faith he is a member of the Reformed Episcopal Church, which he serves as vestryman. In politics he is a Republican.

Mr. Ripple married, October 23, 1906, Lois Schlager, daughter of Charles Schlager, of Scranton. Children: Ezra H. 3rd, Dorothy Lois, Marjorie Elizabeth.

---

#### GEORGE F. REYNOLDS

The Reynolds family, formerly of Fell township, of which George F. Reynolds of Scranton is a representative, descends from the New England

family, founded at Plymouth, Massachusetts, 1643, and at Kingston, Rhode Island, twelve years later. About 1750 a branch of the family moved to Litchfield county, Connecticut, and came thence with the first settlers of the Wyoming Valley, under the Connecticut charter in 1769. The family is conspicuous in the records of the events of those early years, figuring in connection with the battle and massacre of Wyoming.

(I) George Reynolds, paternal grandfather of George F. Reynolds, came at an early day from Rhode Island, settling in Fell township, now Lackawanna county, where he owned 300 acres of land. His was the first framed house in the township erected prior to 1825, it being covered, sides and roof with long white oak shingles split out of the log. In 1825 he built the first framed barn in the township, having in 1824 built the pioneer saw mill. This mill erected on Fall Brook in the southwest part of the township, was destroyed by a flood, was rebuilt and again was carried away by a flood, no mill having since been built on the site. The old log school house built about 1820 on the creek, and known as the "Carr School House," was presided over in 1825 by John Nelson—among his pupils were, Samuel, Maria, George and Sheff Reynolds. The first wedding solemnized in Fell township was in 1827, one of the high contracting parties being a Reynolds: Maria, who married Otis Williams.

(II) George (2) Reynolds, son of George (1) Reynolds, was born in Rhode Island in 1817, and was but a baby when his parents came to Fell township. He attended the old log school house sessions and grew up as was the lot of the pioneer boy, to hardships and toil. He helped to clear and cultivate the soil, to sow, reap, thrash and grind, living a farmer's life until 1859, when he moved to Scranton and opened a grocery store on Penn avenue. He prospered in business, continuing several years at that location, then moved to the west side, here he lived retired several years prior to his death in 1900. His wife, Mary Ann Phinney, was born in Connecticut, in 1823, daughter of James H. Phinney, who kept the Bristol House at Providence for many years, Mary Ann, his daughter, spending her girlhood in Providence. She died aged eighty-six years, in October, 1910. Both George (2) and Mary A. Reynolds were members of the Methodist Episcopal church. Six of their eight children grew to mature years: James S.; George F., of whom further; Ida, deceased, married J. L. Harding; Clarence E. Phinney, and John C., deceased; Blanche and Annie, both died young, the former aged three years, the latter aged fifteen months.

(III) George F. Reynolds was born in Fell township, Lackawanna county, Pennsylvania, January 7, 1848. He attended the public schools of the township and later took a course at Duff's Business College at Pittsburgh. Later still he became identified with the well known home college course inaugurated by the Chautauqua Association and for ten years he was a member of the Chautauqua Literary and Scientific Circle, finishing his courses and being graduated. He began business life as a clerk in Harding's grocery store, but after a year moved to Oxford, New Jersey, where he was time-keeper at the iron works for three years. He then made a trip to the oil region of Pennsylvania, but finding the oil business very unattractive he took the before mentioned course at the business college in Pittsburgh, then returned to Scranton. He entered the employ of the Lackawanna Iron and Coal Company, as bookkeeper and clerk, continuing in that employ for twenty-eight years, acquiring a splendid standing with the company for reliability, dispatch and industry. In 1900 he severed this connection and established a real estate and insurance business in Scranton. He operates extensively, buying large tracts and dividing them into building lots. In this manner he added West Park, a tract of 120 acres to Hyde Park. He is secretary and treasurer of the Keystone Land Company,



and is a director of the Peoples National Bank, an institution he aided in organizing. A successful business man and capable executive, Mr. Reynolds adds to this the qualities of a good citizen, an earnest supporter of church and Young Men's Christian Association work. He is a member of the Elm Park Methodist Episcopal Church; has been secretary of the board of trustees continuously since 1874 and served two years (1880-1882) as superintendent of the Sunday school. During the years 1880 to 1882 he was president of the Young Men's Christian Association and during this period taught a Sunday school class. In 1900 he was provisional delegate from the Wyoming conference of the Methodist Episcopal church to the general conference, held that year in Chicago. Mr. Reynolds is active in all departments of church work other than those mentioned; is public spirited and generous, social and refined in his tastes and devoted to his home and family. He is a member of the New England Society of Northeastern Pennsylvania. There is little of true benefit to his community in which he is not interested and his support is confidently relied upon for all forward movements.

Mr. Reynolds has been twice married, his first wife being Miss Ida A. Ware, of Pedricktown, New Jersey. Her death occurred in 1888. In 1895 he married Mrs. Katherine (Wynkoop) Wylie, daughter of William Wynkoop, of Newton, Pennsylvania. Children: William W.; Arthur E. and Margaret, the latter a child of Mrs. Reynolds and her first husband.

---

#### GEORGE F. STUCKART

Although a young man, Mr. Stuckart has risen to a position of responsibility in business and has shown ability of commensurate proportions. His years of banking experience fitted him for his present position as secretary and treasurer of the Anthracite Trust Company, his selection for this office being a natural result, following the careful attention he gave his previous positions and the ability displayed in the fulfillment of his duties. There being no effect without a cause, and in no line of business is merit quicker recognized than in banking, so surely there are greater honors in store for Mr. Stuckart, one of the youngest banking officials of Scranton.

George F. Stuckart is a son of Anthony F. and Mary C. (Reinhart) Stuckart, the former born in Austria, Europe, coming to the United States when eighteen years of age. He landed in New York City, and for a time remained there, later locating in Stroudsburg, Pennsylvania. He was for many years in the employ of the Delaware, Lackawanna & Western Railroad Company, meeting death in a railroad accident. He married Mary C., daughter of George Reinhart, of Tannersville, Pennsylvania. Children: George F., Paul, Loretta, Joseph.

George F. Stuckart was born in Stroudsburg, Pennsylvania, October 25, 1878. He was educated in public and parochial schools, Wood's Business College and Saint Thomas College. He began business life with the Globe Warehouse Company; then for five years was bookkeeper for the Maloney Oil and Manufacturing Company of Scranton; the succeeding three years were spent with the Merchants' and Mechanics' Bank as bookkeeper; in 1909 he was appointed cashier of the Olyphant Bank, having been the first appointee to that position; in 1910 he was elected secretary and treasurer of the Anthracite Trust Company, which office he now most capably fills. Mr. Stuckart enlisted in 1896 in Company F, Thirteenth Regiment Pennsylvania National Guard, and in 1898 volunteered with the regiment for service in the Spanish-American War. He enlisted as a private, was at first detailed to the hospital corps, later returned to his company and was mustered out with his

regiment with the rank of corporal. While detailed with the hospital corps, he acted as secretary to the brigade surgeon. He is a member of the congregation of Saint Peter's Cathedral; is past faithful navigator of the Fourth Degree Knights of Columbus; member of the Benevolent and Protective Order of Elks, and in political faith is a Republican. Mr. Stuckart married, June 10, 1902, Ella R., daughter of Adam Dougherty, of Scranton.

---

#### ARTHUR C. FULLER

The ancestry of the Fuller family in America includes a progenitor who came to this country in the Mayflower, Edward Fuller, and Jesse Fuller, the sixth American generation of the name, who according to the Massachusetts Muster and Payrolls and the Rhode Island Service records, was a soldier in the Revolutionary War, enlisting from the two states previously mentioned.

Charles A. Fuller, father of Arthur C. Fuller, was a native of Southbridge, Massachusetts, born January 21, 1821. By trade a builder and carpenter, he became the owner of a planing mill at Clinton, New York, and prospered. His later life was spent in retirement in Utica, New York. He married Carile Gates.

Arthur C. Fuller, eldest son of Charles A. and Carile (Gates) Fuller, was born at Clinton, Oneida county, New York, February 27, 1849. He attended the district and high schools of Clinton, New York, but although prepared for college entrance, relinquished his opportunity for further study and secured employment as clerk in a store in Clinton, where he remained two years. The following year he entered the branch office of the Remington Agricultural Works at Utica, New York, and was soon transferred to the main office of the company at Ilion, New York. After three years' service he entered the stove manufacturing field in the employ of J. S. and M. Peckham, of Utica, New York, an industry in which he attained marked success. For nine years he was in charge of the finances of that company, serving faithfully and well, resigning to remove to Scranton. He here contracted relations with the Scranton Stove Works, and with J. A. Lansing purchased the controlling interest, became treasurer of that organization, and acted in that capacity for thirty years, resigning in 1912. This business was established and incorporated in 1866 as the Scranton Stove and Manufacturing Company and was later changed to the Scranton Stove Works, a corporation numbering among its founders men of such prominence as the late Colonel J. A. Price, J. J. Albright, J. C. Platt, H. S. Pierce, J. A. Linen and William Connell. In 1892 the business was moved from its old factory on West Lackawanna avenue to its present site, where a large and suitable plant was erected for it, which, including the additions recently constructed, is one of the largest plants devoted exclusively to stove manufacture in the East. Of the nine acres occupied by the works, three and one-half are under roof. Four hundred men are employed therein, the principal product being "Dockash" stoves and ranges. Mr. Fuller's present connection with this flourishing concern is as vice-president, but he is not at present active in the management.

Mr. Fuller is otherwise identified with Scranton interests, being vice-president and director of the Lansing Hardware Company; secretary, treasurer and director of the Scranton Textile Company, and also holds the same positions with The Scranton Mills, which is the selling company for the former; and was for several years director of the Scranton Savings Bank until its consolidation with the Dime Discount and Savings Bank in 1913. He belongs to the Green Ridge Presbyterian Church and is secretary of the board of trustees. He also holds membership in the Scranton Club and the Green Ridge

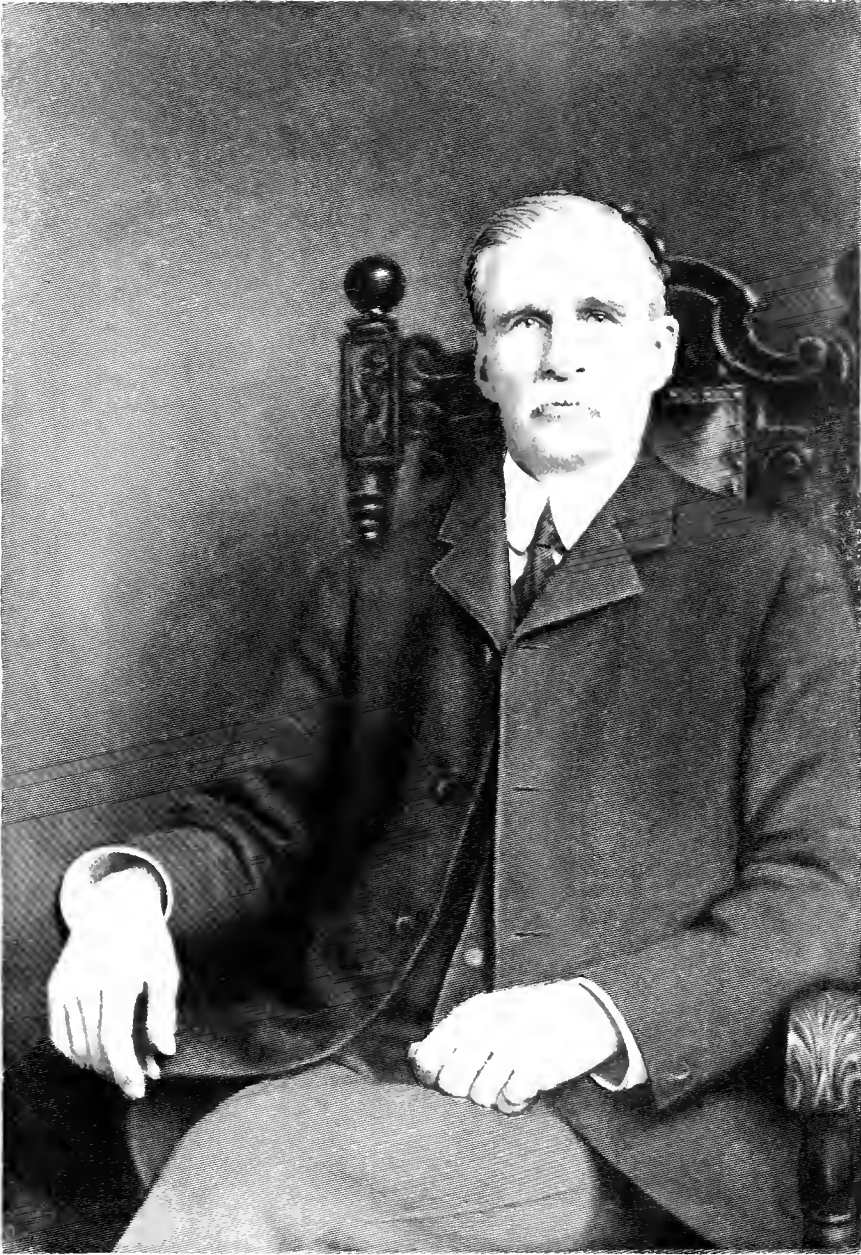

*A.C. Fuller.*



Club, and he was one of the organizers and for eleven years treasurer of the New England Society of Northeastern Pennsylvania. The society at its annual banquet in 1903 presented him with a silver loving-cup, inscribed as follows: "Presented by the New England Society of Northeastern Pennsylvania to Mr. Arthur Charles Fuller, in recognition of efficient services as Treasurer, 1892-1903."

He married, December 17, 1873, Clara Woolworth, daughter of Cornwell and Angeline (Coe) Woolworth. Children: Howard A., a graduate of Lafayette College, in the scientific course, now located at Seattle, Washington; Ray W., a graduate of Lafayette College with the degree of electrical engineer, learned the stove business at St. Louis, Missouri, and at Quincy, Illinois, married Grace Sanderson, and they have two children: Arthur C., Louise S.; Florence L., died aged three years; Floid M., a graduate of the Massachusetts Institute of Technology, Boston, Massachusetts, in the mechanical and electrical engineering courses, now of Duluth, Minnesota; Warren L., connected with the Delaware, Lackawanna & Western Coal Company as concrete engineer, married Hazel Tobey.

Mr. Fuller is numbered among the successful manufacturers of the city and is an authority on all departments of his business. His wise judgment and careful and persevering financial acumen are attributes contributing largely to the prosperity of the several organizations with which he is connected. Public-spirited to the highest degree, he is ever forward in encouraging enterprises which can in any way advance the interests of Scranton. A keynote to his success in his many undertakings is his executive force and mastery of detail in whatever engages his attention. To a natural dignity of manner Mr. Fuller adds a geniality that wins for him hosts of friends and makes him welcome wherever he goes.

---

#### ISAAC POST

The Post family is of ancient German origin. As early as A. D. 980 we find among the conquerors of Nettelburg, later known as Shaumburg, Herren Von Post, and in 1030 Adolph Post was a member of the Reichstag of Minden. From the local name Von Post doubtless came the surname Post, for in the same town, Ludwig and Heinrich Post, in 1273, appear as witnesses to a deed, and this Heinrich was progenitor of a prominent German family.

(I) Goossen Post, a descendant of Heinrich Post, and from whom the American family is traced by the family historian in an unbroken line, is mentioned in 1376 as one of the *anzienlijkste* *Arrheimsche* *burgers*. Arnheim is in that part of Netherlands called Gelderland. He had a wife, Jantje, daughter of Peter and Jane (Ropalje) Van Zul. They had sons: Peter, mentioned below; George.

(II) Peter Post, son of Goossen Post, owned land in 1399 in or near Elspet, and is thought to have married Annatie, daughter of George and Else (Meyers) Suydam, of Zwolle. Children: Peter Arnold, mentioned below; George, said to have emigrated to England and to have settled in county Kent about 1473, and his will was filed at Canterbury, 1502; Jan.

(III) Peter Arnold Van Der Poest, son of Peter Post, is given in the Post Genealogy as son of Peter, and his birth year as 1500, but it is probable that some generations were missed in the search. Goossen Post must have been born about 1325 to be a city officer in 1376, and his son Peter, who owned land in 1399, was born, say as early as 1365. Peter Arnold would be according to this reckoning, over a hundred years younger than his father. Peter Arnold married Marragrietje, daughter of Jan Bogert, and had sons: Jan.

whose daughter Sarah married in Maidstone, Kent, September 15, 1607, Isaac Clark, or Clerk; Panwell, mentioned below.

(IV) Panwell Van Der Poest, son of Peter Arnold Van Der Poest, married, February 7, 1571, Susannah, daughter of Abraham Van Gelder. Children, baptized at the Dutch Church, Austin Friars, London: Abraham, October 6, 1573; Sarah, same date; Susanna, January 18, 1578; Jan, November 5, 1579; Arthur, mentioned below.

(V) Arthur Post, son of Panwell Van Der Poest, was baptized August 26, 1580. He married, February 2, 1614, in Maidstone, Kent, Bennet, daughter of Richard Lambe. That he was the father of the American pioneer, Richard, is deduced from a "deed" dated June 14, 1644, "being of grete age Arthur Post give to my cousin Richard Van Mulken; my second son Stephen and his wife Margaret; lands, tenements and hereditaments in Estling, formerly in the possession of my eldest son Richard, being now of New England, or some parts beyond the seas. Panwell, my youngest son, to have my wearing apparel." (Phillips Coll. Mss. in Mulken Gen. Mss. XXII, 4). This must mean will, not a deed in the proper sense of the word.

(VI) Lieutenant Richard Post, immigrant ancestor, son of Arthur Post of England, is said by the genealogy and other authorities to have settled first at Lynn and Woburn, Massachusetts, it is true, and was a taxpayer in 1643. But we have record that he married in Lynn or Woburn, February 27, 1649-50, Susanna Sutton, and that in the same locality a Richard Post married, November 18, 1662, Mary Tyler. The records seem to show, however, that Richard Post went with the pioneers from Lynn to Southampton, Long Island. He shared in every division of the common land, and from 1643 to 1687 he was prominent in the records of the town. It is true that he may have returned to Lynn for two wives, but it is not known that the Southampton man had any other wife than Dorothy (given in some works as Johnson). He was constable, marshal, magistrate, lieutenant, commissioner to treat with the Indians, on a committee to settle a dispute between the town and Captain Topping, patentee under Governor Andros' patent. The original homestead of Post was on the east side of Main street and has lately been owned by Captain Charles Howells and Henry Post. Before he died he deeded land to his sons, John and Joseph Post, daughter Martha, wife of Benjamin Foster, and grandson, Benjamin Foster Jr., April 17, 1688. He died in 1689. Children: Martha, married Benjamin Foster; Joseph, was in business in Talbot county, Maryland, in 1675, returned to Southampton and died there November 10, 1721, aged about seventy-one years, leaving a will; John, mentioned below.

(VII) Captain John Post, son of Lieutenant Richard Post, was born about 1650, doubtless at Southampton. He was progenitor of all the Post families of eastern Long Island; Montrose and Honesdale, Pennsylvania; Palmyra and Newburgh, New York, and California. The homestead of Captain John Post, was on the east side of Main street, Southampton, and the railroad station occupies part of it at present. He was one of the purchasers of the house and lot bought for and dedicated to the use of a Presbyterian parsonage "forever," and the property is still owned by the church. His will was dated December 9, 1687, and proved at Southampton, March 21, 1687-88, bequeathing to five sons and three daughters, homestead, close at the head of the creek, a fifty-pound commonage, the house and home lot formerly his father's, the close that was his father's between the Mill path and Cobb's Pound path, close at Long Springs and his fifty-pound allotment at Mecox; land at Hog Neck, west of Canoe place and in Great place. He died in 1687. He married, in 1671, Mary ———. Children: Mary; Captain John, mentioned

below; Jeremiah, settled in Hempstead; Sarah; Dorothy; Martha; Deborah; Richard, lived at Hempstead, became a Friend.

(VIII) Captain John Post, son of Captain John Post, was born in 1673, at Southampton, died there in 1741. In 1690, when he was about seventeen years old, he was trading land, and in 1692 he was buying and selling land, and his name was on the tax list. In 1712 he was a trustee and proprietor and purchased for the town the North End Burying Ground in which his uncle Joseph was the first man buried. From 1714 to 1739 he was many times elected to public office, serving as trustee, collector of taxes, assessor, commissioner on disputed boundaries and captain of the military company (as shown by the records at Albany). He died in 1741. He married Mary Halsey. Children: John, born 1704, died 1792, married Abigail Halsey; Joseph, born 1704, died 1780; Isaac, mentioned below.

(IX) Isaac Post, son of Captain John Post, was born in 1712, died May 8, 1785. He married Mary Jessup, and among his children was Isaac, mentioned below.

(X) Isaac Post, son of Isaac Post, was born in 1741, died in 1788, killed by a fall from a tree. He married Agnes, born June 1, 1764, died May 2, 1834, daughter of Joseph and Deborah (Hudson) Rugg (see Rugg II). His widow married (second) Bartlett Hinds, born April 4, 1755, and had two children: Richard Hinds, born December 17, 1795, and Barlett Hinds, born June 7, 1797. Children of Isaac and Agnes Post: Isaac, mentioned below; and David, born July 26, 1786, died February 24, 1860.

(XI) Isaac Post, son of Isaac Post, was born August 12, 1784, in Southampton, Long Island, New York, died in Montrose, Pennsylvania, March 23, 1855. He was one of the early settlers of Northeastern Pennsylvania, coming to Montrose in the early part of 1800, where he became one of the prominent men of the community. He conducted a general store, and also kept an inn. He took a foremost part in every good project in the community, and was instrumental in establishing the first bank in that section. He held various offices of honor and trust, was major of the Second Battalion of the State Militia in 1811, and was also inspector of the Second Brigade; he was treasurer of Susquehanna county in 1812; a member of the state legislature from Susquehanna county in 1828; judge of Susquehanna county in 1837. He was a member of the Masonic organization, holding membership in Hiram Lodge, No. 131, of Newburg, New York. He married, in 1805, Susannah Hinds, the ceremony being performed by Thomas Tiffany, Esq. She was born November 10, 1782, died November 15, 1846, daughter of Bartlett Hinds (see Hinds V). Their children were: Mary Ann, born March 6, 1806, died April 17, 1806; William Leander, April 26, 1807, died February 26, 1871; Albert Lotan, March 25, 1809, died December 6, 1886; Mary Susannah, May 25, 1811, died March 23, 1812; Susannah Jane, April 4, 1813, died February 9, 1819; Agnes Ann, September 25, 1815, died June 22, 1816; Isaac Lucius, mentioned below; Jane Amanda, November 14, 1820, died October 25, 1903, unmarried; Elizabeth Vallonia, July 4, 1825, died October 4, 1853, she married Gordon Dimock, M. D., of Montrose, Pennsylvania, who was a surgeon in the Civil War; George Leonidas, September 24, 1828, died December 5, 1841.

(XII) Isaac Lucius Post, son of Isaac Post, was born July 11, 1818, in Montrose, Pennsylvania, died December 8, 1899. His education was acquired in the district schools. During the Civil War he served in the paymaster's department of the Army of the Cumberland, under Colonel Asa Holt Jr., and after the war, in 1865, he removed to Scranton, Pennsylvania, where he was for a number of years engaged in the insurance business, and where he also

served as justice of the peace and alderman. He was active in the Pennsylvania Avenue Baptist Church, of Scranton. He was a very stalwart Republican and was instrumental in bringing Congressman Galusha A. Grow before the public, assisting materially in raising the funds for his campaign. Mr. Post was married, July 28, 1846, by the Rev. H. A. Riley, at Montrose, Pennsylvania, to Harriet Amanda, born February 26, 1828, died at Scranton, November 22, 1895, daughter of William and Amanda (Harris) Jessup. To this union was born one son, Isaac, mentioned below.

(XIII) Isaac Post, son of Isaac Lucius Post, was born November 21, 1855, at Montrose, Pennsylvania. He attended the public and high schools of Scranton and Professor H. H. Merrill's Academic and Primary Training School. He began his business career October 1, 1873, as messenger boy of the Third National Bank of Scranton, and a year later, December 2, 1874, became messenger of the First National Bank of Scranton. His ability and fidelity to duty were rewarded by promotion and he was advanced by various steps to positions of larger responsibility. He became assistant cashier, January 4, 1886, and in October, 1891, cashier, a position he has filled since then with conspicuous ability. He enlisted in the Scranton City Guards during the labor disturbances of 1877, in Company A, and with other members of the company was mustered into the Thirteenth Regiment, National Guard of Pennsylvania, October 10, 1878. He was discharged May 25, 1885, with the rank of first sergeant. In politics he is a Republican; in religion a Presbyterian, being a member of the First Presbyterian Church, which he served as trustee for several years.

He married, February 16, 1887, Emily Pierson, born at Roselle, New Jersey, April 14, 1861, daughter of Hiram Pierson and Caroline Elizabeth (Shnyder) Baldwin, the former late general passenger agent of the Central Railroad of New Jersey. Children: 1. Margaret Baldwin, born April 12, 1889; married October 8, 1912, Reuben B. Pitts, president of the Hermitage Cotton Mills, Camden, South Carolina; one daughter, Emily Post Pitts, born July 18, 1913. 2. Evelyn Jessup, February 22, 1892; married, June 13, 1913, Douglass T. Lansing, of the Lansing Hardware Company, Scranton. 3. Norman Baldwin, January 3, 1896, died March 26, 1900, at Scranton. 4. Carolyn Elizabeth, August 27, 1897.

---

#### WILLIAM R. WILLIAMS

Although numbered among the older business men of Scranton, a finer example of well preserved manly vigor, one would have to go far to find. His life, begun in far away Wales, the family seat for many generations, has found its full fruition in the wonderful city his muscle, brain and genius has helped to create.

William R. Williams was born March 10, 1846, in the borough of Carmarthen, capital of the county of Carmarthen, South Wales, a city of over 10,000 inhabitants, situated on the river Towy, eight miles from its mouth and twenty-three miles northwest of Swansea. He is the son of Reese and Catherine (James) Williams, both descendants of old Welsh families. Reese Williams was a man of good education and one of the most expert cabinet makers and fine wood workers of his city. He died in his native town in 1851, age twenty-eight years. His wife, Catherine, was a daughter of William James, of Vrongach, a town in the same part of South Wales.

William R. Williams at an early age was thrown upon his own resources, first obtained a good education, passing his boyhood years at the home of his paternal grandfather, William Williams, owner and operator of Nanty bar



mill. William Williams was also a carpenter and cabinet maker, and on arriving at suitable age William R. Williams became his apprentice, continuing until he fully mastered the trade. He remained in Carmarthen until his twenty-fourth year, then married and a month later sailed for the United States, locating finally in Scranton. This was in the year 1869, and from that date until the present he has been one of the factors of Scranton's greatness. His first employment in his adopted city was with his cousin, Daniel Williams, a contractor and builder, who appointed him foreman over his men, then engaged in the construction of the Belleville Church. He continued as journeyman until about 1878, when he began business for himself as a contractor and builder. He had a very successful career as a builder, eighteen churches and innumerable residences having been erected under his supervision, in Scranton and the Lackawanna Valley. He continued in business as a contractor until 1898, when in association with Frank Washburn and Evan S. Jones he organized the Washburn, Williams Company, founded on the remains of the Washburn, Zearfoss Company. Mr. Williams was chosen treasurer of the new company, a position he yet holds. The business of Washburn, Williams Company is that of lumber dealers and contractors, at Nos. 119-131 Meridian avenue, with the branch yards at other points. (A full account of the company is found in the sketch of Evan S. Jones, president of the company (1913).) A practical builder and an experienced contractor, the services of Mr. Williams have been invaluable to the company, while his wise and careful management of its finances has safely brought them through the difficulties that ever beset an industrial corporation depending, as it does on so many outside conditions over which it has no control. That the company has reached its present state of prosperity is a living testimony to the business acumen of its owners, all men of brain, energy and wisdom. But in every undertaking the final test of strength is in financial condition and here the wisdom of Mr. Williams, as a financier, has been most conspicuous.

Not only in the management of the finances of the Washburn, Williams Company, has his worth been appreciated, but for the past twenty years he has been a director and vice-president of the West Side Bank, giving to that institution the same careful attention bestowed on his private and corporate affairs. For twenty-seven years he has been treasurer of Hyde Park Lodge Free and Accepted Masons, a term of service unequalled in the history of that lodge. He is also a member of Lackawanna Chapter, Royal Arch Masons, and of Coeur de Lion Commandery, Knights Templar. In religious faith he is a Presbyterian, a member, and for the past twenty years a deacon of the Welsh Presbyterian Church. For many years he was a teacher in the Sunday school, which he also served as superintendent. His wife is also a communicant of the church, a member of the Ladies' Aid Society and active in general church and benevolent work.

Mr. Williams married, in 1869, in his native land, Gwenllian, daughter of Richard Rosser, of Hirrwain, South Wales; children: Gwilym, died age thirty-one years; Edna; Tudor R., of further mention.

Tudor R. Williams, only son of William R. and Gwenllian (Rosser) Williams, was born in Scranton, September 4, 1881. He attended the public schools of Scranton and graduated in 1899 from the School of the Lackawanna. He then entered Cornell University, from which he was graduated as a civil engineer in the class of 1903. Returning to Scranton he was appointed resident engineer for the American Railways Company, which position he held for three and one-half years. To broaden and make more practical his engineering training he then entered the employ of the Washburn, Williams Company, in charge of the contracting department and continuing so for

three and one-half years. When the company was organized he was chosen vice-president. In 1910 Mr. Williams, deciding to adhere more closely to the engineering profession, formed the partnership of Williams & Richardson, engineers and contractors, for the purpose of entering the field of reinforced concrete design and construction. Until the formation of this partnership, reinforced concrete in this vicinity was very rarely used. Since that time, however, many buildings have been made fireproof when originally designed in wood, only by the alertness and training of Williams & Richardson in economically bringing about such a change at no greater cost. Mr. Williams owes the foundation for his success to the honor and experience of his father before him. Mr. Williams is a member of the Engineers' Society of North-eastern Pennsylvania, Scranton Board of Trade, and the First Presbyterian Church. At Cornell University he was elected to class societies and the Kappa Sigma fraternity.

In 1906 he married Anna, daughter of Mr. and Mrs. Charles W. Spencer, formerly of Oil City, Pennsylvania. Children: Gwen and Janet. Family residence at No. 1322 Gibson street.

---

#### WILLIAM CAWLEY

Although a young man Mr. Cawley's banking experience covers a period of eighteen years, in fact his entire business life, he having begun as book-keeper with the Dime Deposit and Discount Bank when a young man of seventeen, fresh from school life. He has held every position in banking life from clerk to cashier and in all has earned the right to further promotion. He is diplomatic and friendly and has that needed quality in the banking business, the ability of winning friends and holding them. Add to a pleasing personality and a friendly spirit a thorough knowledge of his business, and you have William Cawley whom it would be libel to call anything but a successful and rising young man.

Mr. Cawley is a grandson of Thomas F. Cawley, a native of Ireland and an early settler in Carbondale, Pennsylvania. When the Pennsylvania Coal Company opened their mines at Dunmore he moved to that town where as a contract miner he ever afterward remained.

His son, Thomas F. (2) Cawley, was born near the present town of Jessup, Pennsylvania; his parents later moved to Dunmore where he attended the public schools. He began business life as a merchantile clerk, later he became a hardware merchant and so continues, his son, Edward F., being his present partner. He married Annie E. Lynett, born in Dunmore, daughter of William and a sister of E. J. Lynett; children: Margaret, William, Edward F., Catherine, Mary, Ella.

William Cawley, eldest son of Thomas F. and Annie E. (Lynett) Cawley, was born in Dunmore, Pennsylvania, May 27, 1878. He was educated in the public schools, continuing until January 10, 1895, when he entered the employ of the Dime Deposit and Discount Bank of Scranton as assistant bookkeeper, continuing ten years, becoming paying teller. In 1905 he resigned to accept the position of cashier of the North Scranton Bank, holding that responsible position four and a half years. He then returned to the Dime Bank as cashier, holding that position until its consolidation with the Scranton Savings Bank. Under the act of consolidation the new institution became the Scranton Savings and Dime Bank, Mr. Cawley being appointed the first cashier, a position he now holds and ably fills. He is a member of the Benevolent and Protective Order of Elks and of the Scranton Club.

He married, June 6, 1906, Agnes Morgan, daughter of B. H. Morgan, an old and present resident of Dunmore; children: Agnes, Fath, Louise, Jane.

---

### CHARLES W. MATTHEWS

As president of Matthews Brothers, Scranton's oldest drug house, Mr. Matthews is at the head of a business with which his father and uncles were connected for half a century, but whose affairs are now wholly conducted by the second generation. Originally founded in 1857, the firm continued as Matthews Brothers under several changes until February 13, 1913, when Richard J. Matthews, the last one of the three brothers, William, Charles P. and Richard J., to enter the early firm and the last to withdraw, sold his interest to Walter L. Matthews and the firm of Matthews Brothers was incorporated under the laws of Pennsylvania. The president of the company, Charles W. Matthews had been a member of the firm many years, succeeding his father, William Matthews, one of the original members. Walter L., the treasurer is a son of Charles P. Matthews, also an original member. Originally a retail business dealing in drugs, paints and oils, a wholesale department was added, both branches being well established and prosperous. The wholesale trade is principally confined to Northeastern Pennsylvania, this being the oldest drug house in that entire section. Under the younger men now in charge the company's high reputation, built up through half a century of upright dealing, is fully maintained and progress is still its motto.

(I) William Matthews, son of Robert Matthews (whose life is given in the sketch of Richard J. Matthews), was born in Cornwall, England, July 12, 1826. Coming to the United States with his parents in 1841, he was educated in the public schools, and grew to manhood in Honesdale, the family's American home. He was there engaged in the meat business with Mr. Henwood for several years, coming to Scranton later, in 1864, and joining his brother, Charles P. Matthews, who had there established a drug, paint and oil store in 1857. The two brothers continued in business for several years, then another brother, Richard J. Matthews, who for nine years had conducted a drug store at Providence, was admitted. In 1872 Charles P. retired from the firm, the two remaining brothers continuing until Charles W., son of William, was admitted, he later succeeding to his father's interest. William Matthews was for many years superintendent of the People's Railway Company, later was its efficient president. He gave his chief attention to the railway, the store management devolving upon his brother and son. He was a man of strong character, broad minded, public spirited and a citizen beyond reproach. In political faith a Democrat, he served his city faithfully as councilman. He was an attendant of the Episcopal church and a supporter of all good causes. He died December 16, 1893, in his sixtieth year. He married (first) Lottie Winton, who bore him a son Charles W. He married (second) Emma Birdsall, whose only child was a daughter Louise. He married (third) Alice Bailey, who bore him sons: Robert and William. He married (fourth) Mary Howell, who yet survives him.

(II) Charles W. Matthews, only son of William and Lottie (Winton) Matthews, was born in Honesdale, Pennsylvania, January 16, 1861. When he was four years of age his parents moved to Scranton where he was educated in the public school, the School of Lackawanna, and "Daddy Merrill's" school. At the age of sixteen years he began work in the drug store of Matthews Brothers, later being admitted to a partnership, then, succeeding to his father's interest at the latter's death, he and his uncle, Richard J

Matthews, became sole owners and proprietors. The firm so continued until incorporated February 19, 1913, Charles W. Matthews becoming first president of the corporation. He has had thorough training for the position, his life since sixteen years of age having been devoted entirely to the business over which he now presides. The store, located at No. 320 Lackawanna avenue, has been the location of the business almost from its first establishment. Mr. Matthews is a member of the Scranton Board of Trade, the Scranton Club and of the Royal Arcanum. He married Emilie, daughter of William J. Pascoe, of Philadelphia. His two sons, Arthur P. and Richard J. (2), are both associated with him in business.

#### DR. FREDERICK DOUGLAS BREWSTER

There has descended to the American people of to-day from the stern, courageous Pilgrims who landed on the New England shore in 1620 a force stronger than the example of a perfect Christian life, more enduring than their wise, firm governments, and more uplifting than the great moral lessons they taught, the very blood of those Christian heroes. Pure and untainted has it descended through the intervening generations, and nowhere can there be found in this broad land one whose American ancestor came to this country in that Heaven-guided band who does not hold his head the higher and feel more keenly the nobility of his race because of that fact. William Brewster, the ruling elder and spiritual leader of the company, he who sheltered the small gathering in his England home and at last led them forth to seek freer lands, was the founder of a family large in number and in greatness second to none.

(I) It is of this family that Dr. Frederick Douglas Brewster is a member, although when Eldad Brewster moved to Long Island from Connecticut the family records were lost.

(II) James Brewster, son of Eldad Brewster, lived on Long Island, and served throughout the Revolutionary War in the Second Continental Artillery from Suffolk county, first as lieutenant and later with the captain's rank. He was the father of two sons and one daughter, Daniel Eldad, Abigail.

(III) Eldad (2) Brewster, son of James Brewster, in 1800 moved from his home at Sag Harbor, Long Island, and settled on a tract of timbered land at Montrose, Susquehanna county, Pennsylvania, which he cleared and later cultivated. He spent his entire life in this place in the pursuit of agriculture. He married Hannah Tyler, of Vermont, a sister of Moses C. Tyler, of Montrose. Children of Eldad and Hannah Brewster: Tyler, born 1814, married, and had a son Samuel, who served in the Union army in the Civil War, and died in the hospital of wounds received in battle; Lucena, born 1816; Horace, of whom further; Daniel, born 1820; Warren, 1822; Andrew Jackson, 1824; Sally, 1826; Ann Maria, 1828; Moses Coleman, 1830. All of the above children, excepting Moses Coleman, attained an age of four score years and over, a wonderful family record for longevity.

(IV) Horace Brewster, son of Eldad (2) Brewster, was born at Montrose, Susquehanna county, Pennsylvania, in 1818. He learned the carpenter's trade and after being employed as a journeyman for a short time began contracting and building operations. Prospering in this line of work, in his later years he desired respite from the cares of business and he moved to a farm near Montrose, this being the one cleared by Eldad Brewster in 1800, where his remaining days were spent, his death occurring at that place in 1904, when he was eighty-six years of age. He married Augusta MacNeil. Children of Horace and Augusta Brewster: Lizzie, married Edward Smith, a resident of





*A. D. Brewster.*

Montrose; Frederick Douglas, of whom further; D. Truman, an attorney of Montrose.

(V) Dr. Frederick Douglas Brewster, son of Horace Brewster, was born at Montrose, Susquehanna county, Pennsylvania, October 8, 1850. He obtained his general education in the public schools of Montrose and the Landford State Normal School, from which latter institution he was graduated in the class of 1871. For the five following years he taught school at Nicholson, Halstead and different places in that region, in 1876 realizing one of his most earnest ambitions and matriculating at the New York Homeopathic Medical College. He received his M. D. from this college in 1879 and immediately began the practice of medicine at Tunkhannock, Pennsylvania, where he was situated for ten years, with gratifying results. At the expiration of that time he came to Scranton, and in that city has met with a large share of success, his patronage being wide and among the best of the city's residents. Dr. Brewster is a member of the County, State and Interstate Medical societies, as well as of the American Institute of Homoeopathy. His fraternal order is the Masonic, in which he belongs to Peter Williamson Lodge, No. 323, F. and A. M.; Lackawanna Chapter, No. 185, R. A. M.; Coeur de Lion Commandery, Knights Templar. His religious belief is Presbyterian and he belongs to the Second church of that denomination in Scranton.

Highly regarded in professional circles for his strict adherence to the loftiest of principles and respected for the qualities of good citizenship he has ever displayed, Dr. Brewster holds a sure and secure place in Scranton society, of which he has been a member for almost a quarter of a century.

---

#### CLARKE BROTHERS STORES

Among the representative men who have won a place of prominence in the commercial circles of Scranton should be mentioned the Clarke Brothers, operating under the name of Clarke Brothers Stores.

Edward M. and George W. Clarke are sons of Matthew W. Clarke. Matthew W. Clarke was born in Ireland and came to Carbondale, Pennsylvania, when only a boy in the year of 1850. He served his time as an apprentice and learned the carpenter's trade, and in 1857 came to Scranton, Pennsylvania, where he followed his trade until 1859. He was of a careful and frugal nature and saved his money, and with this small capital he opened a general store in Hyde Park, being one of the first merchants there. By close attention to his business it grew and was successful, and he continued in this line up to the time of his death which occurred in 1890. During the rebellion he enlisted in the Union army and served during the last year of the war. His political affiliations were with the Democratic party in whose principles he firmly believed. He took an active and intelligent interest in the affairs of the ward in which he lived and served as one of its school directors, assisting to the fullest extent in bringing the public schools to the highest standard.

He married Mary Clarke, who was born in Ireland. Her parents settled in Philadelphia, Pennsylvania, where she spent her childhood. They moved from Philadelphia to Scranton in 1855. She survived her husband and resides in Scranton, Pennsylvania, now aged seventy years. Mr. and Mrs. Matthew W. Clarke were the parents of the following children: 1. and 2. Edward M. and George W., whose history is given more fully further on in this article. 3. Jennie W., who married B. W. Jenkins, of Baltimore, Maryland, a descendant of one of the oldest and most prominent families of that city, the ancestors of whom came to America with Lord Baltimore in 1632 and from that time to the present they have always been represented there. 4.

Isabella, who married Captain Louis Mason Guilick, of the United States navy, now attached to the battleship, Arkansas; Mr. and Mrs. Guilick make their home in Washington, D. C. 5. Elizabeth, who married Asbton Deveraux, a nephew of the late Archbishop Ryan, of Philadelphia, Pennsylvania, where Mr. Deveraux is a prominent lawyer.

Edward M. and George W. Clarke were both born upon the present site of their large store at Nos. 310 to 322 North Main avenue, Scranton, Pennsylvania, which was the home of their father for some years. The date of the birth of Edward M. was September 30, 1868, and it was in the public and high schools of his native city that he obtained the rudiments of his education. He began his business life as a boy in his father's store and continued in this until the death of the latter. He then became associated with his brother, George W. Clarke, forming the firm of Clarke Brothers and opening a department store at No. 322 North Main avenue, having at that time a force of about twelve employees. They gave their entire attention to the business and have built up a large and flourishing business. To meet its demands, the Homestead was removed and upon its site was built the present large store, one hundred and fifty feet front by two hundred feet deep and four stories high, having a floor space of one hundred thousand square feet. This building is not only the largest in Scranton, Pennsylvania, but probably the largest in any city in the country the size of Scranton, which is given up to all the departments known to the modern store.

But this is only one of their chain of stores; they have another at Nos. 901 and 903 Pittston avenue, one at Nos. 101 and 103 Drinker street, one at Nos. 102 and 106 West Market street, all in Scranton, Pennsylvania, and in addition to these have stores at Carbondale, Olyphant, Dunmore, Providence, Wilkes-Barre, Nanticoke, Pittston, Plymouth, Shenandoah and Mahoney City. The stores in Plymouth, Shenandoah and Mahoney City were opened in 1914. Not only do they operate retail, but also wholesale departments in these stores, and the territory from Forest City to Shenandoah is covered by their representatives and wagons. In November, 1913, the firm of Clarke Brothers was terminated and its place was taken by the corporation known as the Clarke Brothers Stores of which Edward M. Clarke is the president and George W. Clarke the treasurer. Edward M. Clarke is also a director in the Liberty Bank of Carbondale, and on the board of directors of the Scranton Board of Trade. He is a member of the Scranton and Country clubs.

George Walter Clarke, the youngest son of Matthew W. and Mary Clarke, was born January 5, 1870, in Scranton, Pennsylvania, as noted above. He was educated in the public schools, and like his brother obtained his early commercial training in his father's store, continuing there until the death of the latter, when, in association with his brother, Edward M., he formed the partnership of Clarke Brothers and has been associated with him to the present time. When the firm was dissolved and the corporation of Clarke Brothers Stores was formed, George W. Clarke was made treasurer, which position he still holds. He is a member of the Scranton Board of Trade, the Merchants' Association of New York City, and the Scranton and Country clubs.

He married, February 10, 1904, Mercedes L., daughter of Richard Rodriguez, of New York City. Mr. and Mrs. George W. Clarke are the parents of two children: George Walter (2), born January 1, 1905; Richard R., born November 22, 1906.



## JOHN R. WILLIAMS

There is an inspiration to future generations in the recital of the life of anyone who has attained a position of prominence in his chosen field of endeavor. But for the biographer, who necessarily becomes acquainted with all the facts and influences surrounding or affecting the success of an individual, there is no more genuine pleasure than to write the story of one upon whom fortune has disdained to smile, to whom all the short cuts to prosperity were blocked, who has been compelled to contend with all unfavorable circumstance, and has, with dauntless determination, stormed the ramparts of fortune and gained entrance to the land of prosperity and reputation reached by the road of accepted opportunity. Such a tale is that of John R. Williams, such the chronicle herein unfolded.

John R. Williams is the son of John F. Williams, a native of Bryn Mawr, Breckenshire, Wales, a miner, who married in his native country and came to the United States with his wife and two sons. John F. Williams first located at Weathersfield, Ohio, in 1869, and after a short time came to Providence, where he remained for about a year, then moved to Peckville, where he engaged in mining. He now lives retired, aged seventy-five years with his family, at the old home. He married Ann, daughter of John Roberts, a native of Wales and a refiner in iron manufacture. Children: John R., of further mention; Edmund F.; Jennie; Margaret, married William J. Lewis; Katherine, married F. W. Covert; Frank. Both he and his wife are communicants of the Episcopal church.

John R. Williams, eldest child of John F. and Ann (Roberts) Williams, was born in Bryn Mawr, Breckenshire, Wales, December 19, 1861. His educational opportunities were decidedly limited and at the age of nine years it was necessary that he find employment. This he did in the neighboring mines where he remained until he was seventeen years of age. He then was engaged on the old gravity road between Peckville and Carbondale, and after two years of this service became a teamster in Peckville. This he continued for one year, his next occupation being as motorman on the Scranton suburban railway, a primitive affair, boasting but two cars of the earliest type, with the motors on the front platforms, chain driven, the chains running back to the rear axle. After four years of this employment he accepted a position with the Scranton Drop Forging Company, and in five years gained a responsible place in the drop forge shop. He resigned this position and became foreman in the plant of the Suburban Electric Light Company. Here his ability and ambition speedily won him definite recognition and he was elevated to the office of superintendent. During the last few years he had been busily engaged in the perfection of a horse shoe calk, there being nothing on the market at that time to insure safe footing for horses. In December, 1902, he severed his connection with the Suburban Electric Light Company and began, with but little assistance, the manufacture of his invention. Although his output was small, he had at first great difficulty in getting his product on the market, being greatly handicapped by lack of sufficient capital. After the first appearance of the article it met with such popular approval and the demand for it was so great that he was compelled to seek more spacious quarters, and after successive additions had been made to his plant, the present factory of two stories, 190 by 100 feet, was erected. Herein are employed over fifty-five hands, and the manufactures are shipped to all parts of the country, seventy-five per cent. of it to points west of Buffalo, New York, through the agency of jobbers, at the present time, besides four different styles of adjustable calks, the most important product of the factory is horseshoes, the firm priding it-

self upon the excellence of their make, an opinion held by many satisfied users. Besides being the first company to make left and right shoes for horses, the Williams Drop Forging Company was the leader in the manufacture of drop forged shoes to compete in the open market with those made by rolling process. How successful that competition has been is best shown by figures, one million shoes being the annual product of the Williams Company, whose product has the reputation of being the finest in the world. In addition to the above, forty thousand shoe calks are manufactured per day; mine bits are made, the factory supplying nearly all used in the valley; and a line of wrenches is included in the company's manufacturers. On December 3, 1903, the incorporation papers of the company were granted by the State of Pennsylvania under the name of the Williams Drop Forging Company with Alfred Harvey, president; John R. Williams, vice-president and general manager; and W. J. Lewis, secretary and treasurer. The present officers are Alfred Harvey, president and treasurer; John R. Williams, vice-president and general manager; F. R. Williams, secretary and assistant treasurer; Edward F. Williams, superintendent.

Mr. Williams is a member of the Iron, Steel, and Heavy Hardware Manufacturers Association, and also belongs to Scranton's Board of Trade. He is a thirty-second degree Mason, belonging to Green Ridge Lodge, No. 597, F. and A. M.; Lackawanna Chapter, Royal Arch Masons; Keystone Consistory, Sovereign Princes of the Royal Secret; and to Irem Temple, Nobles of the Mystic Shrine. He also holds membership in the Temple Club. While interested in politics to the extent demanded of a good citizen, he has never sought office nor done more than cast his vote with the Republican party, in whose principles he is a firm believer. Both he and his wife are communicants of the Baptist faith.

He married Rose, daughter of W. A. Beeman, of Scranton. They are the parents of one daughter, Norma. As the inventor of an article that has opened a new industry, Mr. Williams has left a permanent record in the history of manufacturing, while he at the same time plays the role of benefactor in rendering the lot of horses much more safe and comfortable, particularly in wintry, stormy weather. In the development of his business he has of course been rewarded with a plentiful share of this world's goods, which none begrudge him as his just portion for his persistent, zealous endeavors.

---

#### NATHANIEL H. COWDREY

Nathaniel H. Cowdrey is the Pennsylvania representative of a family that has been seated in Connecticut since the early Colonial days of that state. His father, Nathaniel A., was born in East Haddam, Connecticut, and there grew to manhood. After preliminary education he entered the Yale Law School and after graduation and admission to the bar, spent his entire life in practice in New York, where he died, aged sixty-five years. He married Jane Hartley.

Nathaniel H. Cowdrey, son of Nathaniel A. and Jane (Hartley) Cowdrey, was born in Hobokus, New Jersey, September 1, 1870. His early life was spent in New York, where he attended the public and private schools, completing his studies at Yale University, whence he graduated A. B., class of 1898. The Spanish War was the topic of paramount interest at the time and he enlisted in Battery A, First Regiment Connecticut Artillery, an organization that neither saw active service, nor was ordered from the state, but was mustered out in October. His first business connection was with the Western National Bank, of New York City, where he was employed for two years.

resigning to accept a position with the Morton Trust Company. He remained with this corporation until February 19, 1910, when he became treasurer of the Title Guaranty and Surety Company, an office he still holds. With the exception of his volunteer enlistment at the time of the Spanish War, his only other military service has been in the National Guard. In 1906 he became second lieutenant of Company I, Twelfth Regiment New York National Guard, and the following year attained the rank of captain. For five years that was his title, until he was made inspector general of the First Brigade with the rank of major, continuing as such until his resignation from the organization in 1912. His fraternity is the Psi Upsilon, with which he became affiliated in his college days. He married Dorothy, daughter of Major Everett Warren, and has two children: Dorothy and Jane. A capable financier, Mr. Cowdrey is a worthy addition to Scranton's business men, among whom he is well liked and popular.

---

### JAMES F. WARDLE

James F. Wardle, broker and promoter, is a descendant of an old English family, of which but two generations have been American born, four having lived on this continent.

(I) Joseph (1) Wardle, father of Rev. Joseph (2) Wardle, and grandfather of James F. Wardle of this narrative, was brought to the United States by his parents when he was four years of age, his father making New York his home for a short time, later moving to Philadelphia, and finally to Lockport, Illinois, where the family resided for many years. Joseph (1) Wardle was born January 27, 1792, and was one of the victims of a destructive cholera epidemic, his death occurring August 10, 1854. He married Sarah Hartless, born February 26, 1797, died July 30, 1890, surviving her husband many years.

(II) Rev. Joseph (2) Wardle, son of Joseph (1) and Sarah (Hartless) Wardle, was born in Leicestershire, England. Besides his public school training he was educated for the Methodist ministry at the Garrett Biblical Institute, of Evanston, Illinois, whence he was graduated B. D. He held charges in the different circuits of the Rock River conference, including different pulpits in the Van Brocklin circuit and at Freeport and Chicago. In 1891 he retired, after an active and useful life, spent profitably and blessedly in the service of his Master. For the past fifteen years he has made his home with his son, James F. Wardle. He is a member of the Masonic Order, holding the Knights Templar degree. He married Mary, daughter of Hiram and Nancy (Haggard) Morris. The Haggard family is one of the oldest in America, dating from the landing of the Pilgrims, and also extends far back into the history of England. Among the more famous of its members is H. Rider Haggard, the celebrated author.

(III) James F. Wardle, son of Rev. Joseph (2) and Mary (Haggard) Wardle, was born in Bloomington, Illinois, August 17, 1867. He received his academic education at Illinois Wesleyan University, whence he was graduated A. B. in 1890, three years later receiving his Master's degree. In the fall of 1893 he came to Philadelphia and accepted a position as road engineer for a firm manufacturing and installing heating and ventilating systems, continuing in their employ for eight years, and in 1901 began a connection with the International Correspondence Schools, that continued for three years. He then became interested in Scranton's new telephone company and was employed in its interests for a time, in 1904 entering the investment and brokerage business independently. One of the many companies which he has pro-

.noted, wholly or in part, is the Mississippi Pecan and Farm Lands Company, with main offices in Scranton, and of which he is secretary and treasurer. He is also vice-president and treasurer of the Southern Lands Sales Company, and vice-president of the Mountain Land Company. Mr. Wardle is a member of the Greek Letter Secret Society, Phi Kappa Psi, Indiana Beta Chapter. He is also prominently connected with the Masonic Order, being past master of Union Lodge, Free and Accepted Masons; past high priest, Lackawanna Chapter, No. 185, Royal Arch Masons; past thrice illustrious master of Scranton Council, No. 44, R. and S. M.; district deputy grand master of the Grand Council of Pennsylvania District, No. 6; past eminent commander of Coeur de Lion Commandery, No. 17, K. T.; Keystone Consistory, Sovereign Princes of the Royal Secret; Irem Temple, Nobles of the Mystic Shrine. He also belongs to the United States Navy League, and is past patron of the Martha Washington Chapter, Order of the Eastern Star. Both he and his wife are members of the Elm Park Methodist Church. Progressive and modern in ideas, Mr. Wardle is a dutiful citizen of Scranton. None of her best interests are disregarded by him and in each forward movement he is an important factor.

Mr. Wardle married Imogene, daughter of the Rev. Jonas Underwood, of Scranton, a minister of the Methodist Episcopal Church, who occupies a Scranton pulpit and fulfills regular ministerial duties, although seventy-eight years of age. Children: Miriam and Evelyn. Mrs. Wardle is a member of the Daughters of the American Revolution; she had four ancestors in the Revolutionary War.

---

#### WALTER LINCOLN HENWOOD

In a business career, covering activities in many states and responsibilities of great weight, Mr. Henwood has demonstrated his value as a constructive force and proven his ability as a wise capable man of business. While he is a native born son of Pennsylvania, his inheritance of English blood is direct on the paternal side, but through his mother, his ancestors, though English, have long been settled in the New England States, coming to Pennsylvania from Connecticut.

Richard Henwood, father of Walter L. Henwood, was born in Cornwall, England, August 6, 1815. He remained in his native land until eighteen years of age, then came to the United States, accomplishing the voyage to New York in the then quick time of five weeks, it usually requiring a much longer time for the sailing vessels of that period to cross the Atlantic. He had not a relative anywhere in the country, but was the first of his family to break down tradition and come to the United States. He obtained work in Rondout, but for a short time only, then in company with H. S. Pierce started westward on a Delaware and Hudson canal boat. At Cuddebackville, just below Port Jervis, New York, obstacles in the canal, prevented further passage of the boat and the two men, followed the tow path on foot until they reached Honesdale, June 13, 1833. The young man, Richard Henwood, at once secured work at fifty cents per day with Daniel Blandin, his first day's work being planting corn in a field now the site of Clark & Company's glass cutting works. The land was then very new, it often being necessary to use an axe to cut up the fallen logs, in order to make room for the corn hills. He continued with Mr. Blandin until 1837, having been engaged a good part of that time in butchering. In 1837 he bought Mr. Blandin's meat business and therein continued for many years becoming prosperous and prominent. In 1861 he was elected a commissioner of Wayne county and on the organiza-





Walter Lincoln Herwood.

tion of the Wayne County Savings Bank, November 1, 1871, he was elected a director, continuing as such until January, 1880. He took a deep interest in the development of Honesdale and to him is largely due its smoothly macadamized streets and abundance of beautiful shade trees bordering them. In November, 1874, he bade adieu to the scenes of his forty years of prosperity and came to Scranton, here attaining the same high position among men of affairs as he had held in Honesdale, although he lived a semi-retired life, not, however, withdrawing to an idle life, but keeping in close touch with the world's progress. He was an ardent Republican, a devoted member of the Methodist Episcopal Church, a man thoroughly respected for his upright life and Christian character. He was sympathetic, kind and generous, many a kindly act done for friend or neighbor was quietly, unostentatiously performed, his final account with the Great Bookkeeper containing numberless credits of this nature. He was far sighted in his investments, enterprising, with a rare judgment and great business ability. His public spirit was manifested in the generous support he gave to all public improvements in both Honesdale and Scranton, the Henwood Block on Lackawanna avenue, Scranton, standing as one of the monuments to his enterprise, erected to improve that section. He delighted in the society of young people, and in his family life he was most affectionate, kind and just. He lived a life untarnished by evil report and left to posterity the rich legacy of an honored name. An incident that illustrates his reputation for strict probity is well worthy of preservation. He was obliged on one occasion to bring suit against a fellow townsman. The defendant thus instructed his lawyer: "Do not cross examine Mr. Henwood, for whatever he testifies will be true and I will swear to it myself."

He was the husband of four wives, marrying (first) Mary Webb, (second) Emma Pascoe, (third) Catherine Bushnell, (fourth) Elizabeth Pierce. He left three sons, all residents of Scranton: William B., a dentist; Sidney R., of the drug firm of Henwood & Company, and Walter L., of whom further.

Catherine (Bushnell) Henwood, mother of Walter L. Henwood, was born in Honesdale, and there died in 1868. Her father, Pope Bushnell, was born in Salisbury, Connecticut, February 11, 1783, died aged ninety-three years; coming to Pennsylvania in 1817. He was a major of the First Battalion, Seventieth Regiment Pennsylvania Militia, and served two terms in the Pennsylvania Legislature as representative from Wayne and Pike counties. He worked for two years aiding Maurice Wurts in securing right-of-way for the Delaware and Hudson canal and won the open hostility of his neighbors when later he advocated the right of the Erie Railroad Company to construct its line through Wayne county. He married Sally Hulbert, born in Goshen, Connecticut, March 26, 1788, died January 11, 1882, at the great age of ninety-four years. She was one of the celebrated family of triplets born to her parents, Sibyl, who died June 27, 1875, aged eighty-seven years; Susan, died October 6, 1876, aged eighty-eight years, and Sally, died January 11, 1882, aged ninety-four years. These instances of longevity have probably never been equalled in one family, the record of the triplets being especially remarkable.

The Bushnell family traces its ancestry from early Colonial days, the first member settling in Connecticut in 1637. A direct ancestor of Walter L. Henwood, one Gideon Bushnell served in the Revolution. The old Bushnell homestead in Connecticut, containing 300 acres on which stands a brick house erected in 1773, is yet owned in the Bushnell name.

Walter Lincoln Henwood, youngest son of Richard Henwood and his third wife Catherine Bushnell, was born in Honesdale, Pennsylvania, November 8, 1864. He attended Honesdale schools until he was ten years of age, his

parents then moving to Scranton, where he attended high school and Merrills Academy, finishing with a course at the business college. He began business life in 1882 as clerk in the store department of the Lackawanna Iron and Coal Company, remaining two years. In 1884 he went to Crown Point, New York, where he took a special course in chemistry under A. S. Bertholet, a noted authority in that field of learning. Mr. Henwood then formed a connection with the Hudson River Ore and Iron Company at their works in Burden, Columbia county, New York, remaining as chemist until June, 1886. He then went to the Black Hills of Dakota, there entering the employ of the Stevens Tin Mining Company, continuing as superintendent until the company closed their mines in that region. At that time one of the greatest railroad contracting firms in the west was Kilpatrick Brothers & Collins, their headquarters and offices located at Beatrice, Gage county, Nebraska. They were, at the time Mr. Henwood left the Stevens Company, engaged in railroad construction very extensively, the Burlington and Missouri and the Union Pacific Railroad, having entered upon their period of greatest expansion. Mr. Henwood entered the employ of this active concern, being first sent to Fort Fred Steele, Wyoming, where he soon afterward was made superintendent over the construction of thirty miles of railroad in the North Platte country. His next assignment was supervising the laying of track on the Burlington and Missouri extension from Curtis, Nebraska, to Cheyenne, Wyoming, the line crossing what was formerly known as "The Great American Desert." On the completion of this line, Mr. Henwood severed his connection with Kilpatrick Brothers and Collins and returned to the Black Hills, again entering the employ of the Stevens Tin Mining Company, as superintendent, continuing until June, 1899, when he left the west and journeyed south. Locating in Virginia, he formed a partnership with a brother Pennsylvanian, A. S. Smith and began contracting railroad construction at Boyd-town. They built thirteen miles of the Atlantic and Danville Railroad, obtaining a substantial profit. He next contracted, in 1890, seven miles of the Lackawanna and Montrose branch of the Delaware, Lackawanna & Western, following this by six months spent on a large contract in Maine. On January 1, 1892, he returned to Scranton, and formed an association with Clark & Snover, one of the largest of Pennsylvania tobacco manufacturers, and of this he became secretary and treasurer.

In 1899, Mr. Henwood formed the firm of Sprague & Henwood, diamond drill contractors, and they have accomplished some of the most notable engineering feats in this line, principal among them being core borings for the great Catskill aqueduct for the city of New York, also the successful boring and completing of four angle holes approximately 2000 feet each in length under the Hudson river at Storm King, a feat never before attempted by any engineering concern in this country.

In 1890, Mr. Henwood retired from the Clark & Snover Company and with Edward F. Lathrop and John J. Shea of New York, organized the Lathrop, Shea and Henwood Company of which Mr. Henwood is vice-president. This corporation was formed for the purpose of doing a general contracting business and has been eminently successful. Among their many contracts may be mentioned the building of the South Buffalo Railway; the mammoth ore dock for the Lackawanna Company of Buffalo, the largest dock in the world; also the ore dock and canal for the Buffalo and Susquehanna Iron Company, thirty miles of railroad for the Pittsburgh, Shawmut & Northern Railroad Company, ten miles for the Buffalo & Susquehanna Railroad Company, twelve miles for the Erie Railroad Company; also the foundation for the beautiful new Lackawanna station in Scranton, Pennsylvania; the power



house and reservoir for the State Hospital for the Insane at Fairview and a vast amount of other work of a like character. In January, 1914, they received two very large contracts now being carried out, for building parts of the great barge canal in the State of New York.

In the various Masonic bodies Mr. Henwood has passed through the different orders including, Peter Williamson Blue Lodge of which he is past master; Lackawanna Chapter, Royal Arch Masons, and Coeur de Lion Commandery, Knights Templar, of which he is past commander. He has also taken thirty-two degrees of the Scottish Rite Masonry, and is a member of Keystone Consistory; also Irem Temple, Nobles of the Mystic Shrine. In addition to these he is a member of the Engineers Club of Northeastern Pennsylvania, and the New England Society of Northeastern Pennsylvania, and Pennsylvania Society Sons of the Revolution. He has developed executive and financiering ability of a high order, while in his special field of constructive activity he is one of the most successful in his operations. In his relations with his fellow men he is a courteous, forceful man of affairs, just, and keenly alive to the importance of straightforward dealing with all. In local affairs he is public spirited and generous, aiding in all movements that make for progress and the public good. He is a Republican in politics.

Walter L. Henwood married (first) at St. Paul, Minnesota, December 22, 1889, Lena L. Pittee, born in California; her parents were natives of Maine. She died November 22, 1901, and Mr. Henwood married for his second wife, January 18, 1905, Esther Pray, of Albany, Georgia.

---

#### SAMUEL SAMTER

In many of Scranton's industrial establishments may be found men in positions of trust, honor, and responsibility, who owe their exalted station to the work of their own brains and hands, but among them all there is no story more interesting or more full of teaching and inspiration than that of Samuel Samter, founder of the firm of Samter Brothers, owners of the largest store devoted exclusively to the outfitting of men and boys in Pennsylvania, Philadelphia and Pittsburgh not excepted. We are prone to believe that the greatest successes in mercantile, industrial or financial life are those made by youths who, through some peculiar quirk of fortune, are brought into recognition and favor with their employers; when in reality as proven by the following narrative, it is the young man who is ever prompt at his task, ever working his hardest at that duty, and performing it better than anyone else, who receives the greatest reward. To anyone who is constantly looking for something better to the neglect of his present obligation, fortune never comes, but the first upward glance of the faithful, conscientious employee lights upon a vision of opportunity beckoning him to come to a field of fairer endeavor and greater effort. So it has been with Samuel Samter, his assiduous attention to study, his quick, clear intelligence, and prompt seizure of every chance for advancement having placed him in a commanding position at the head of one of Scranton's most distinguished business houses.

Prussia is the land from which the father of Samuel Samter, Jacob Samter, came to this country, and there for generations the family had been known as expert tailors. It is usual in that country for a trade or profession to be handed down from one generation to another, the father teaching his son all of the secrets of the occupation. So it was that for many years the Samters had been tailors and, in the usual line of descent, that was the trade learned by Jacob Samter. He, however, appreciating that fact that through all the preceding years there had been no advance in the family's station in life,

determined to break the bonds of tradition and to come to America, where life might be begun anew and fresh vigor infused into the blood of future generations. He established in business in Brooklyn and from the start did a flourishing business, prospering in a degree unheard of in his native land. He married Bertha Lesser and became the father of five children: Samuel, of whom further; Jennie, married Maurice Levy, of New York City; Theresa, married Dr. J. B. Potsdamer, of Philadelphia; Isaac, of Philadelphia; Benjamin, of Scranton.

Samuel Samter, son of Jacob and Bertha (Lesser) Samter, was born in New York, New York, October 24, 1851. He was given the opportunity for an excellent education, which he eagerly improved, and after completing a course at the public schools, entered Brooklyn Polytechnic Institute, whence he was graduated. Not caring to learn the trade of his father, he left home to lay the foundation of his future career and directed his steps toward Scranton, then in the full vigor of its strong and rapid growth. He answered a newspaper advertisement for a boy to make himself generally useful for three dollars a week and found it necessary to urge the advertiser to accept his services. Before his engagement he was able to assist his later employer in closing a sale involving a large amount and was placed upon the pay-roll. Upon his departure, three weeks later, he was offered a salary of \$100 a month to remain, but refused. He next entered the employ of Moore & Finley. When he began work, Mr. Moore asked him what salary he wanted, Mr. Samter named no figure, simply saying, "It is up to you now, but it will be up to me bye and bye." Here he remained for three months, leaving to enter business independently. When he announced his intention to Mr. Moore, the latter, in expressing his regret at the loss of his services to the firm and in wishing him good fortune, concluded with "I thought as much." In the spring of 1872, he opened his store in the Valley House block, employing only one person, working in the store himself. In 1883 he moved to the Old Washington Hall, a building up to that time more accustomed to the applause greeting the efforts of the best actors and actresses of the day than to the mingled noises of a mercantile establishment. This edifice was razed in 1888 and in its place a four story brick building erected, which has been added to at various times until the floor space of the store is now 27,000 square feet. A few years after the establishment of the business his brother, Benjamin, became partner, the business being conducted at the present time, as Samter Brothers. In 1911 incorporation was made and the company organized with Samuel Samter, president; Benjamin Samter, vice-president, and A. J. Levy, secretary and treasurer.

The store of Samter Brothers has an ideal location on the corner of Penn and Lackawanna avenues, at the central city terminal of the Scranton Railway Company. The number of employees is 110 and men's and boys' clothing is the only line of goods carried. The patronage of the firm has steadily increased and caters to the best of Scranton trade. It is to the credit of the city that it is the home of its largest men's and boys' outfitting store, and a monument to the organizing power and constructive ability of Mr. Samter.

Mr. Samter married Julia, daughter of Emanuel Klauber, of Munich, Bavaria, and has three children: Minnie, married A. J. Levy, of Scranton; Jeanne, married B. Heinz, of Scranton; Evelyn.

---

#### JOSEPH JEFFREY

Born in England, and transplanted to a foreign land at the age of sixteen years, Mr. Jeffrey has taken kindly to his American surroundings and has

here flourished and prospered as "one to the manner born." He has won an honored position in the Scranton Gas and Water Company and has ably seconded the effort of the Scrantons, father and son, to extend that company, to improve its service and to render it of still greater importance in the development of the communities it serves. While the responsible post of secretary and treasurer has in a large degree confined Mr. Jeffrey to office activity, he has nevertheless borne an active part and is a most important part of the machinery that drives the corporation known as the Scranton Gas and Water Company.

Joseph Jeffrey was born in Lancaster, England, May 23, 1867, son of William and Hannah (Bees) Jeffrey, the former now a retired miner aged seventy-one years. William Jeffrey, born in 1842, spent the first forty-one years of his life in his native country, following there the occupation of a miner. In 1883 he came to Scranton where he continued at the business he knew so thoroughly, mining, continuing for several years before laying aside the implements of his trade and calling.

Joseph Jeffrey attended school in his native shire until twelve years of age, gaining a foundation for his years of later study and self-improvement. From twelve to sixteen years of age he was employed at such work as a lad of his years was capable of performing, and in 1883 he came with his parents to Scranton, which has since been his home as it has theirs. In England he had been time-keeper for the Wigan Coal and Iron Company and in Scranton his first employer was O. S. Johnson in whose mine office he started work. Later he clerked in a Dunmore store for a few years, then became an employee of the Fairlawn Store Company, remaining with them until April 19, 1889, when he entered the employ of the Scranton Gas and Water Company, as bookkeeper. Here he found his true sphere of activity and ten years later he had risen to the position of assistant secretary and treasurer of the company, and in 1906 was elected to his present office, secretary and treasurer, which he most capably fills. The position he holds has been fairly won and came to him in the way of promotion for valued service to the corporation he served. The men with whom he has been so long associated, and who know him best, appreciate him most, and consider no honor they can bestow upon him is undeserved. Mr. Jeffrey is a member of the Dunmore Presbyterian Church and president of the board of trustees. He stands high in the Masonic Order, belonging to King Solomon's Lodge, Free and Accepted Masons, of which he is an honored past master; Lackawanna Chapter, Royal Arch Masons; Melita Commandery, Knights Templar; and Irem Temple, Nobles of the Mystic Shrine, the latter a Wilkes-Barre Temple.

Mr. Jeffrey married, in 1892, Annie, daughter of George Raught and sister of John Raught, the well known artist of Scranton. Children: Albert R., Willard, Louis.

---

#### WILLIAM G. O'MALLEY

There is no more important duty laid upon political officials of to-day than to carry out in all local governments the phrase in the preamble of the Constitution of the United States stating that one of its purposes is to "promote the general welfare." In our municipal governments the public welfare is safeguarded and directed by the director of public safety, necessarily a man of action, decision and wise, far-seeing judgment. It is, therefore, no mean tribute to the estimation in which William G. O'Malley is held that he

occupied this responsible position as the guardian of the peaceful and law abiding citizens of Scranton during the years from 1909 to 1914.

County Mayo, Ireland, has been the seat of the O'Malley family for many generations, where all the earlier generations were tillers of the soil, hard-working, good men, but who never acquired more than a modest competence because of the lack of opportunities in that land. It was not until three generations ago that one of the line determined to break the chains of patriotism and sentiment that bound him to the land of his fathers, the far famed "Emerald Isle," and to seek his fortunes across the sea. Edward O'Malley, father of Thomas B. O'Malley, and grandfather of William G. O'Malley, came to this country about 1848, settling in Carbondale, Pennsylvania, when there were but few settlers in that place. He brought with him his son, Thomas B., who lived in Carbondale until his marriage to Miss Bridget Cannon, who died December 8, 1912, aged fifty-eight years, daughter of James Cannon, when he moved to Scranton. While in his former place of residence he had been employed in the coal mines, but upon coming to Scranton secured a position in the steel works. By his marriage with Bridget Cannon he had seven children: Michael F., James, Mary, William G., Eugene, Thomas F., Daniel.

William G. O'Malley, son of Thomas B. and Bridget (Cannon) O'Malley, was born in Carbondale, Pennsylvania, July 4, 1878. He was given the opportunity of a public school education, but the ambition to begin work and to earn his own way in the world was too strong in him to permit of toilsome drudgery at books. Consequently at the age of eleven years he forsook the school room and obtained work on a delivery wagon for a local meat market. His next employment was in a grocery store, followed by a term of service in the Lackawanna mills. He then became a clerk in the office of E. J. Walsh & Company, in 1903 entering the office of the city engineer in the same capacity. After one year's service his energetic application to duty gained recognition in his promotion to the chief clerkship in the department of public works. In two years he resigned his office to become treasurer of the O'Malley Manufacturing Company, manufacturers of brass goods and plumbing supplies, usually employing about seventy-five men, and for three years was entirely out of public service; he also served as director of this company. On April 4, 1909, he was installed in the office of director of public safety, continuing there until January 1, 1914. Thoroughly efficient in his position and striving constantly to raise his department to the same plane in every respect, Mr. O'Malley gained the confidence of the city administration to such an extent that almost no interference was made in his execution of city laws and ordinances. Scranton may pride itself upon having during the period of five years which Mr. O'Malley served as director of public safety an official whose one obsession was the proper protection of the inhabitants of the city, and who was ever on the alert for anything detrimental to the "general welfare."

Mr. O'Malley is a member of the Knights of Columbus; the Fraternal Order of Eagles; the Modern Woodmen of America, in which society he is treasurer of the local camp; the Scranton Bicycle Club; and the Scranton Canoe Club at Lake Winona. He married Anna O'Hara, daughter of Patrick O'Hara, of Scranton.

---

#### JAMES E. DAVIS

This branch of the Davis family dates in Pennsylvania from the time of the arrival of Evan P. Davis, an orphan boy of about seven years, who came in company with an uncle from his native land, Wales. With the usual thrift of his race he prospered and left behind him an honored name.

Evan P. Davis was born near Merthyr Tydvil, Glamorganshire, Wales, December 19, 1851, died in Scranton, Pennsylvania, June 2, 1902. He was early orphaned and did not long remain in his native land. When about seven years of age he came to the United States, coming with a relative to Providence, Lackawanna county, Pennsylvania. He obtained an education, began working around the coal mines and finally became an efficient mine superintendent. He was a member of the Welsh Baptist Church, and a good man. He married Mary Ann Evans, born in Minersville, Schuylkill county, Pennsylvania, February 29, 1852, died May 11, 1902, leaving two children: Elizabeth, married to Robert H. Carson, of Scranton; and James E., of whom further.

James E. Davis, only son of his parents, was born in Nanticoke, Pennsylvania, May 1, 1885. His early and preparatory education was obtained in the public schools, he being a graduate of the high school, class of 1902. He then entered Princeton University, whence he was graduated A. B., class of 1906. After leaving the university he began the study of law under the direction of Samuel B. Price, of Scranton, and after the required examination was admitted to the bar in February, 1908. For two years following his admission he was associated in practice with Samuel B. Price, continuing until May, 1911, when he established a private practice with offices at Nos. 408-409 Connell Building. His practice is general in its character, excepting that he does not accept criminal cases. He has been solicitor for the Scranton school district since July 1, 1912. Mr. Davis has obtained a good start in his chosen profession and has every prospect of a successful future. He is secretary and treasurer of the Lackawanna Law and Library Association, a member of the First Welsh Baptist Church, and is a Republican in politics.

---

#### MADISON F. LARKIN

To note exactly how prominent a part heredity has played in the mental and moral composition of Madison F. Larkin, a glance at the following will suffice. In him are embodied the virtues of a parent of rare steadfastness of character, the traits of the father descending to the son, and raising the one to the same station of lofty respect held by the other in a preceding day and generation.

Of English ancestry, the seat of the Larkin family in its native land was Lark River, Suffolk county, England, where available records of those of the name trace back to the latter part of the twelfth century. The exact date of the American immigration is uncertain, but in the eighteenth century Botetourt county, Virginia, was the home of the branch of which Madison F. Larkin is a member, later Clermont county, Ohio, claimed its residence and finally Pennsylvania.

Joseph Franklin Larkin, father of Madison F. Larkin, was born at Felicity, Clermont county, Ohio, January 12, 1821. Until he was fifteen years of age he attended the common schools and numbered among his playmates and classmates Ulysses S. Grant, of Civil War and Presidential fame, and, when not in school, performed farm labor on his father's land. It was the custom in those days to supply the field hands with liquor and it was thus early in life that he made a stand for his principles and refused to labor where such a practice was carried out. After holding a position as clerk in a store at Neville he learned varnishing in the same village. He then apprenticed himself as a clerk to Robertson & Shields, merchants of Batavia, Ohio, for a term of three years, in return for "board and washing and fifty dollars a year," but, the firm discontinuing before the expiration of his contract, he was

released therefrom and was employed in various country stores until he was eighteen years of age, when he was offered a position in the wholesale dry goods house of Wood & Sharp, in Cincinnati, through the good offices of a friend of his father, Rev. Maxwell P. Gaddis. After a short time spent in the employ of this firm he accepted a position in the bank of B. W. Hewson & Company, in which he became an assistant and afterward teller, making his home with Mr. Hewson's family and enjoying his highest confidence and trust. The bank closing its doors in 1842, he identified himself with Hopper, Wood & Company, proprietors of an auction and commission house. Two years later he formed a partnership with John M. Wood, under the firm name of Wood & Larkin, wholesale dealers in dry goods, and in 1848 retired from the firm, selling his interest to his partner. He then purchased the store of Hines, Strobbridge & Company, but soon after, finding the burden of maintenance too heavy for his resources, discontinued the business and settled with his creditors for forty per cent. of their claims. It is here that praise must be given Mr. Larkin for the manner in which he kept his credit and reputation clear of any taint of suspicion, as twenty-three years later he assembled his old creditors and made payment of the balance with six per cent. interest from the date of his assignment, the honorable course of a man of honor, who disdained to use the letter of the law as a shield from his just debts. From 1849 to 1853 he was in the employ of Thomas Sharp & Company, and the following year was connected with Morris S. Hopper & Company, as a member of the firm, then acting as collector in the State of Indiana. It was in the days of free bank currency and the unstable paper issues were used in that state at a discount varying from five to forty per cent. and, aware of the fact that the same money passed in Ohio at a much higher rate, Mr. Larkin conceived the idea of speculation. Opening an office in the banking house of James F. Meline & Company, Cincinnati, he began the buying and selling of free bank notes in Indiana and Ohio and negotiating loans on securities from contractors on the Ohio and Mississippi Railroad, from which he progressed into a general brokerage business, and in 1857 entered upon a regular banking business, subsequently forming a partnership with George and Thomas Fox under the firm name of Larkin, Fox & Brother, which continued for three years. Mr. Larkin's well known reputation for integrity and reliability attracted a large clientele, a prosperous business resulting, to which he gave his exclusive attention. In 1866 the firm expired by limitation, and that of Joseph F. Larkin & Company rose from its ashes, capitalized at \$150,000, financed by some of the leading capitalists of the city. As the head of this institution, Mr. Larkin added to his prestige in the financial world, and at the dissolution of the firm by limitation in 1871, he formed the firm of Larkin, Wright & Company, with a capital of \$300,000, which straightway became a power in the business world and transacted an immense business from its organization. He later purchased the interest of his partner and the business was continued until 1881, safely weathering all the storms that wrecked so many frailer barks on the sea of finance. In the aforementioned year the Metropolitan National Bank was organized to take over the business of J. F. Larkin & Company with Mr. Larkin as president, a position he resigned in 1883 to participate in the formation of the Cincinnati National Bank, of which he became president.

Early in 1867 he, with other prominent men, had organized the Union Central Life Insurance Company. The founders of this company were men of integrity and high character in the business and religious world. There are found among them the names of Adam Poe, John M. Reid, R. S. Rust, D. D., Rev. A. Meharry, Asbury Lowery, D. D., Bishop John M. Walden.





777. F. Larbin



Bishop Davis W. Clark, and among the business men such names as John M. Phillips, James Gamble, William A. Proctor, Justice Stanley Matthews, Dr. William B. Davis, William M. Ramsey and Harvey De Camp.

Grateful in the highest degree for the material blessings that had been conferred upon him, Mr. Larkin all his life held to the old system of tithes and from his earliest youth placed aside one-tenth of his income for use in charitable purposes. The religious characteristic in his nature was acutely developed and from the age of fourteen years he had been a member of the Methodist Episcopal church, in later years well deserving the misused title of pillar of Saint Paul's Church, Cincinnati. There was nothing propitiatory or expiating in his religion, his was the simple, trusting love of faith. In the time of financial embarrassment of the Cincinnati Wesleyan College, his were the donations that kept life in the institution, and he likewise gave generously to the maintenance of Wesley Chapel, in which he worshipped for forty years. The Loveland Camp Meeting Association was also the object of his generous contributions and he financed the now famous Methodist Book Concern, while the National Association for the Promotion of Holiness, formed in Philadelphia, received the benefits of his gifts. He was one of the organizers of the Freedmen's Aid Society, advancing its endeavors in every possible way. His entire life was characterized by total abstinence from indulgence in any form of narcotics or spirituous liquors.

Mr. Larkin married (first) in 1844, Emeline Wood; (second) Julia Ann Stark, daughter of William T. Stark, of Xenia, Ohio, a lineal descendant of the Stark family, boasting of John Stark of Revolutionary fame. In her young womanhood she was an intimate friend of Lucy Webb, who became the wife of Rutherford B. Hayes, a friendship continuing through life.

Madison F. Larkin, son of Joseph F. and Julia Ann (Stark) Larkin, was born in Cincinnati, Ohio, October 15, 1855. His preliminary education was received in the public schools, his later academic training in the Ohio Wesleyan College. He began his business career as messenger in the private banking house of Larkin, Wright & Company, of which his father was senior member, at Cincinnati, and soon became paying teller. In 1875 he was seriously affected by the deaths of a brother and sister, and, his health demanding it, left home in search of outdoor occupation. Going to Galveston, Texas, with a letter of introduction to a banker, who has since become well known, J. W. Seligman, he was prevailed upon by that gentleman to accept a position in a branch bank at Goliad, in that state, by the argument, that, with the change of air and climate, outdoor life was neither necessary nor desirable. Only partially convinced, Mr. Larkin soon after returned to his original determination and engaged as a drover (one of thirty) to drive 4000 head of cattle from Goliad to Waco, Texas. This was the beginning of a concatenation of events that provided him with many thrilling experiences, which reached their climax in a flat-boat trip down the Red and Mississippi rivers from Shreveport to New Orleans, with three companions. They reached their destination, where they were unacquainted, safely, but penniless and shabbily clothed, sold their craft for a dollar, bought bread, and endeavored to appease their ravenous hunger. Mr. Larkin was rescued from what was fast becoming a pitiable plight by the arrival in port of the river steamer Charles Morgan, commanded by a friend of the family, Captain Steir, who fed and clothed him, aided his companions, and gave him transportation to Cincinnati. Although the exercise and exposure had greatly improved his physical condition, it was thought that he could still further profit by the bracing atmosphere of the west, and he set out for the home of his uncle, a prosperous trader, in Arizona. While in this region he added to his store of adventurous experiences by a

hairbreadth escape from a band of Indians, eluding them only by the fleetness of his horse. At Phoenix he was a clerk in a general store and also served as agent for the Wells-Fargo Express, being one of its first agents in Arizona. While here he had a narrow escape from sharing the fate of a companion with whom he was sleeping, who was crushed to death during a terrific tornado by the roof of their store collapsing.

In January, 1877, Mr. Larkin accompanied King Woolsey, president of the Upper House of the Territorial Legislature, to Tucson, and in that year's session served as secretary on the committee on territorial affairs, which reported favorably on the request of the Southern Pacific Railway for franchise. While in this city, which was but a rapidly grown town, he witnessed many of the territory's earliest political scenes, in which a revolver shot was too frequently the settlement of a dispute.

In 1879, through the friendly offices of John J. Valentine, president of the Wells-Fargo Express Company, he became employed in the Bank of Arizona, and while engaged in that institution had an interesting experience as a theatrical manager. A company playing the comic opera "Pinafore," a production then in the height of its popularity, with Pauline Markham as leading lady, was stranded in Tucson.

Mr. Larkin, assuming the entire responsibility and expense, brought it to Prescott and billed it for a two weeks' engagement, to the enjoyment of the populace and the benefit of the members of the company, who were nothing loath to leave the scene of their late misfortune and retrieving triumph. Filling his bank position to the satisfaction of his employers and gaining their confidence by his dependability, he was offered a position in the bank of Arizona at Phoenix, also as the agent of the stage company and of the Wells-Fargo Express Company. Resigning his position he wrote an acceptance of the offer and soon after followed his letter to Phoenix, only to learn that his epistle had miscarried and that some one else had been called from California to fill the office. Disappointed, of course, by this vagary of fate, Mr. Larkin nevertheless was not discouraged or disheartened by his misfortune, but, returning to Prescott, entered the service of the quartermaster's department at Whipple Barracks under Major Grimes, and there served until 1881.

He bade farewell to the country that had provided him with such a store of adventure and experience, in 1881, and returned east, entering the United States National Bank of New York, then one of the leading financial centers of the metropolis, and won speedy promotion, being thrice advanced in one year, and at its close holding a position as individual bookkeeper. He resigned this to become president of the East End Lumber Company of Cincinnati, which he conducted successfully for seven years, until the lumbermen's war of 1890, which his company could not survive, and in consequence was forced out of business. Returning to the banking business, he entered the Market National Bank of Cincinnati, remaining there until the first of January, 1897, when he moved to Kansas City, Missouri, where he was in the employ of the National Surety Company (now of New York City), and subsequently of Swift and Company, the celebrated meat packers. Here he was engaged in a struggle the like of which he had never encountered in all his varied experience, a conflict with himself. On the one side there was the necessity of providing for his wife and himself, on the other, the voice of conscience which would not permit him to perform the Sabbath labor required in his new situation. It was a trying moment for a man with no visible means of support should he resign, for his father had lost his all in the Cincinnati bank closure, and more than once he was on the point of giving in, but cast his decision for the right when his devoted wife, ever the best of companions pro-

nounced herself as ready to share any hardships or to endure any privation in order that the lofty principles, as dear to her as to him, should not be dragged in the dust. So was the decision made and his resignation forwarded, and to this pair, true to their nobler selves and joyful in the costliness of their sacrifice, came a telegram from T. J. Foster, of Scranton, offering him an important and lucrative place with the International Text Book Company. Surely this was divine watchfulness and care of His own. Entering the service of this corporation with renewed zeal and strengthened faith in the security of his destiny, he applied himself vigorously and devotedly to his duties and won immediate attention by his assiduous application to his tasks. Attention necessitated favorable comment, and following this came promotion, first to chief accountant, then assistant treasurer, and finally, December 1, 1902, controller of the company. At the present time he fills this office and the same on the officary of the International Correspondence Schools, truly a wonderful rise, possible only to one of exceptional merit. He is also controller of the International Educational Publication Company, treasurer of the Scranton Life Insurance Company, and an influential member and treasurer of the Scranton Board of Trade.

Mr. Larkin has ever been a worker in the ranks of the Prohibition party, his views and convictions on the subjects forming the basis of that party's platform coinciding minutely with those of his honored father, and in 1910 he allowed his name to be advanced as candidate for governor of Pennsylvania on that ticket. Disregarding his chances for victory, facing certain defeat, he displayed in that campaign much of the same spirit that caused him to resign his position in Mississippi and stood before the people of Pennsylvania as the earnest exponent of a principle of immeasurable height. History records that he was defeated, and by the same token records a campaign that strengthened the prohibition cause in one of the very strongholds of its foes and showed the supporters of the liquor traffic an ever increasing power that will, in time, sweep on to victory. In 1912 he was a candidate for Congress from the Tenth District and in 1913 for treasurer of Lackawanna county, both candidacies unsuccessful. He is a devoted Methodist and is one of the most ardent of religious workers among the laity. He is a member of the board of stewards of the Elm Park Methodist Episcopal Church, ex-president of the Men's League of Elm Park, president of the City Evangelization Union, president of the Scranton City Rescue Mission, and ex-president of the Laymen's Association, Wyoming Conference. His gifts to charities are large and his gifts of time and service larger still, the two combined making him a power for good of inestimable value to the community and a haven of refuge to those disowned by fortune and cast out by society.

Mr. Larkin married, in 1889, Hattie E. Harrington, daughter of David Chase Harrington, of Philadelphia, Pennsylvania. They have one son, Curtis H., who received the major part of his education at the Bordentown Military Institute, Bordentown, New Jersey, and at this time just out of the Technical High School of Scranton. Mrs. Larkin's character is one of true nobility, peculiarly adapted to her husband's, a union of charming freshness, beauty and strength resulting from their marriage.

Mr. Larkin's record speaks more eloquently than can the pen of biographer of what manner of man he is. God-fearing and upright throughout his entire life, his is the reward of fidelity to duty and the dictates of conscience. Having risen to regnance over self, the greatest conquest was his, all his following triumphs and success springing therefrom.

## HENRY F. FERBER

Henry F. Ferber is a descendant of a German family, whose seat for many generations has been the grand duchy of Baden, Germany. The emigrant ancestor of the name was Augustus C. Ferber, born in Baden in 1824, where he obtained his education and learned the baker's trade. When he was twenty-four years of age he came to the United States, locating in Scranton, and for nine years was employed by the Scranton Coal Company, assisting in the opening of one of the first mines ever worked on Roaring Creek. In 1853 he moved to Pittston and there followed the trade he had learned in his native land, that of baker, but only remained there for five weeks, then returning to Scranton and to his former employers. While the family was residing in Pittston, Henry F., (of whom further), was born. After holding a position as watchman at the Diamond Mines, Augustus C. Ferber established in the draying business and was so engaged until the years before his death. For six years he served his city as chief of police, during the administration of Mayor Mooney. At the time of Lee's invasion of Pennsylvania, he enlisted in one of the companies of Emergency Men that were formed, but never was in active service. Both he and his wife were active members and regular attendants of the Immanuel Baptist Church.

He married Mary, daughter of Chester Fram, a veteran of the War of 1812. Her grandfather fought in both the war for independence and the War of 1812. Their children, who reached maturity, were: Christina, Martha, Henry F., (of further mention), Elizabeth, Emma, Edward, Ella, and Jennie.

Henry F. Ferber, son of Augustus C. and Mary (Fram) Ferber, was born in Pittston, April 1, 1853. He attended the public schools until he was nine years of age, but was then compelled to discontinue his studies and to obtain employment in a coal breaker. Determined not to be thus deprived of all the advantages accruing from an adequate education, he paid a Mr. Kohler for instructing him in the branches of which he felt he would have the most need, receiving these lessons after a day of the most exhausting kind of labor in the breaker. At the age of thirteen years he apprenticed himself to the Scranton Stove Works, to learn the trade of stove moulder, following that occupation until 1875, when he went into the draying business. His business flourished and he continued in that line until 1894, when he sold his interests. He has been identified with the city fire department since 1866; was elected chief 1876, served one year; again elected 1882, 1883, and 1884, but was displaced by changes in the administration. In 1893, he was once more appointed to that position, serving three years and in 1901, August 1, was again appointed by William L. Connell and has held the position ever since. During his continuance as head of the department it has attained a high grade of efficiency, has been provided with all modern equipment, and holds high rank among those of other cities of the country. Mr. Ferber was a lad of twelve years of age when the Civil War broke out. With the intense patriotism of youth, he was eager to join the army as drummer boy, but could not of course obtain parental permission. Thoughts of battle, long marches, and stirring campaigns became an obsession with him, and on five different occasions he made an effort to enter the service, claiming that his parents were dead. On one occasion he had been accepted and had donned his uniform, when the chief of police entered the recruiting office and compelled him to return home. The chief of police was the nemesis that upset his fondest hopes, as on each occasion that he tried to enlist, it was he who detected him and returned him to his parents. They, while full of pride in the youth and his love of country, would not permit him to go to the front. His only military connection has

been three years service in Company B, Thirteenth Regiment Pennsylvania National Guard, commanded by Captain Kellogg.

He married Mary, daughter of John O. Jones, of Pittston. Children: Harry F., a member of the Scranton fire department; Miriam married W. W. Scheuer and lives in Scranton; Lucille, at home.

Mr. Ferber is the able head of the department of Scranton's municipal fire system noted for its efficiency. With the best of apparatus, efficiently manned by a band of brave and daring firefighters, the property of the taxpayers of Scranton is safeguarded, as far as is possible by human means, from the ravages of fire. Mr. Ferber has been a member since 1876 of Union Lodge, No. 291, F. and A. M., of Scranton, and belongs to the Temple Club, a social club of Masons. He is also a member of the International Associations of Chief Engineers; Keystone Fire Chiefs; Pennsylvania State Firemen's Association, in which he has held the office of president; Firemen's Relief Fund of Scranton; Volunteer Firemen's Association of Scranton; the Scranton Liederkrantz, and the German Alliance of Scranton. He belongs to the Royal Arcanum. In 1914, at the beginning of Mayor E. B. Jermyn's administration, Fire Chief Ferber recommended the elimination of horse drawn apparatus and to install motor operators instead; this being done, they have seven pieces of motor apparatus consisting of tractors, triple pieces and combination autos.

---

#### WILLIAM C. HESSINGER

From Germany, the ancient home of the family, to New York, thence westward to Wisconsin, and then to Scranton, where the present day representative of this branch of the family resides, is the course followed by the Hessinger family in America. Ever a respected and honored name during the time the family has been in the United States, none has been more worthy of honor and respect. All in this country have led busy and useful lives, engaged in occupations necessary to society, and never committing depredations upon the prosperity of their neighbors or seeking for gain without giving in return of their talent or labor.

(I) The emigrant ancestor, Theodore Hessinger, came to this country when a young man, and settled in Williamsburg, New York. While there he was married and moved to Sheboygan, Wisconsin, in both places following his trade of cabinet maker, which he had learned in his native country from a workman who was a master in his art and of wide reputation for the beauty and skillful execution of his work. He later came to Scranton, being among the first settlers, and formed a triple partnership for work at his trade, one of the other members being named Grieser. He became quite prominent in the public life of the city and was a member of the board of alderman.

(II) Henry Hessinger, son of Theodore Hessinger, was born in Sheboygan, Wisconsin, in 1856. He learned his trade with his father, and in 1868 engaged independently in the furniture and undertaking business on the South Side. His efforts met with gratifying success, the upbuilding of a flourishing business being interrupted by his death in 1890. Both he and his wife were members of the German Presbyterian Church. He belonged to the Patriotic Order Sons of America and the Independent Order of Odd Fellows. He married Margaret Kiefer, daughter of Charles Kiefer; children: William C., of further mention; Frank T., of Philadelphia; Edward R., of Scranton.

(III) William C. Hessinger, son of Henry and Margaret (Kiefer) Hessinger, was born in Scranton, Pennsylvania, August 21, 1881. He obtained his

early education in the public schools of the city, later attending Woods Business College in preparation for his active career. For a time he was employed in woolen mills in the city, and since that time has been actively engaged in the establishing and conducting of the New Citizens' Building and Loan Association, of Scranton, of which he is secretary. While the titles of the other officers sound much more imposing it is upon the secretary of such an organization that the real burden of its business falls, and Mr. Hessinger, with his other business interests, has his time well filled. He is also secretary of the Globe Silk Manufacturing Company, a corporation organized in 1906 with the following officers: H. J. Ziegler, president; Henry Frey, vice-president; Henry F. Ziegler, secretary; Louis Schumacher, treasurer; and Joseph A. Gnos, manager. At the present time the officers are unchanged, except that William C. Hessinger has replaced Henry F. Ziegler as secretary. The short life of this company has still been a prosperous one. They employ seventy operators, and have on an average seventy looms running. This product reaches the market through commission merchants.

Mr. Hessinger is a member of Schiller Lodge, Free and Accepted Masons, and General Grant Commandery, Knights of Malta. Both he and his wife belong to the German Presbyterian Church and are regular attendants at its services. He married Caroline Naher, daughter of Peter Naher, of Scranton, and they have one son, Paul W.

Tremendously energetic, and directing his energies in an intelligent manner, Mr. Hessinger has proven himself indispensable to the different organizations which he serves, holding their highest confidence and giving the best of his labors to their interests.

---

#### THOMAS B. HOWE

Of English ancestry, Captain Phineas Howe, grandfather of Thomas B. Howe, was one of the early settlers of Wayne county, securing land from the government and rendering service in the War of 1812. He founded a large family, many descendants being found in Wayne and adjacent counties, men of worth in their several communities. His descendant, Thomas B. Howe, representative of the Scranton branch, is a native son of Wayne county, Scranton being his home by adoption. The old pioneer added to the wealth of his country by converting wild forest land into fertile fields, but his grandson has created wealth and prosperity for man through his inventive genius and the thorough business ability that successfully placed his inventions on the market. The lot or the inventor is usually to furnish the genius to contrive and construct without participating in the pecuniary reward that follows each meritorious invention, but Mr. Thomas both sowed and reaped, gaining fame as an inventor of useful, long needed appliances, and a high position in the business world.

(II) His father, Abraham S. Howe, son of Captain Phineas Howe, was born in Wayne county, there lived the life of a farmer and butcher and there died in 1856, meeting his death by drowning at the age of fifty-one years. He married Rebecca Bortree, daughter of an old Wayne county settler.

(III) Thomas B. Howe, son of Abraham S. and Rebecca (Bortree) Howe, was born in Wayne county, Pennsylvania, July 14, 1849. He was but a lad when his father died and after finishing his studies in the public school of his district, he began learning the carpenter's trade. He became a skilled worker and continued a builder for eleven years. About 1878 he entered the employ of the Delaware, Lackawanna & Western Railroad as fireman, later becoming an engineer. Locomotives at that time were built with stationary

grates, a system both wasteful and inconvenient. Mr. Howe pondered the problem, long and carefully, finally perfecting and patenting a shaking grate, the first one ever placed in a locomotive, being his patent and used on Delaware, Lackawanna & Western engines running out of Scranton. After four years as fireman and engineer he resigned to take personal charge of the manufacture and installation of his grate and other patented improvements. He is the father of twenty-eight patented inventions of practical value, the last being a steam dryer used for drying sand. Mr. Howe many years ago became interested in sand and gravel banks in both New York and Pennsylvania, and has made the development of such properties his chief business. He is president of the Scranton Sand Company, with plant at Waverly, New York; manager of Sayre Sand and Plaster Company, of Sayre, Pennsylvania, and is president of the Ariel Sand Company of Scranton, organized in 1912, with Thomas B. Howe, president and manager, and R. C. Ruthven, secretary and treasurer. The Ariel Sand Company is one of Scranton's successful concerns, it having been formed to supply the large local demand for sand and gravel, now so plentifully used in constructive work. Mr. Howe is also a director of the Waverly Chamber of Commerce. He is an independent in politics, always deferring to his convictions regardless of party in choosing his candidates. He is public spirited and generous, and so holds the confidence of the voters of his ward, the thirteenth, that he was chosen their representative in the city council serving one term. He is a member and past master of Green Ridge Lodge, Free and Accepted Masons; is a companion of Lackawanna Chapter, Royal Arch Masons; a Sir Knight of Melita Commandery, Knights Templar and a noble of Irem Temple, Nobles of the Mystic Shrine. He is also interested as a stockholder in the Union National Bank; First Mortgage and Guaranty Company, of Philadelphia and Black Diamond Silk Company.

Mr. Howe married, September 26, 1873, Maria H., daughter of William Copeland, an Englishman of Turnersville, Lackawanna county, where Mrs. Howe was born. Children: Everett T., now of Rochester, New York; Rean M., now widow of Dr. A. G. Fall. Little more than a glance is here given of the useful life and manly character of Thomas B. Howe. Broad minded, progressive, just and generous, it is a matter of gratification to all, that from his genius of invention and soundness of executive management, wealth has come to him in abundance. It has been fairly earned and is rightfully used. The world is better, brighter and richer for his having lived in it; he has created not destroyed and his sixty-four years of life have been spent in a manner that can cause him nothing but satisfaction in its review.

---

#### SAMUEL F. YORK

Yorkshire, England, was the home of the early generations of the York family, represented in Scranton by Samuel F. York, a stock and bond broker of Scranton, his children being the only members of this branch born in America. Never identified with the industrial or manufacturing interests of the great cities of the country, the Yorks have ever been found in the country villages or dwelling on their estates in rural England. Theirs was the free, unfettered, life in the open fields; theirs the pleasure of walking through the sunlit meadows by the running brooks; theirs all the beautiful scenes of which the English poets fondly sing, for which Browning, with a son's love, pines, in his "Home Thoughts From Abroad." It was because of this innate love of life near to nature that Thomas York, grandfather of Samuel F. York, all his life lived in Shadforth, England, where he was the

proprietor of one of the inns for which the English country side is famous. Here he lived quietly and peacefully, a courteous, cordial host, keeping in touch with the events of the world beyond his own immediate horizon by conversation with the travelers who stopped at his inn for supper or for a night's lodging. Here William F. York was born in 1850 and grew to manhood. In him the instincts of the husbandman were lost and he sought the thriving industries of the city, learned the machinist's trade, and in 1882 came to America. An expert machinist, familiar with every department of his trade, he found no difficulty in securing a position, and was employed by the Dickson Manufacturing Company as erecting machinist. He superintended the erection of many intricately made machines, his last work in the employ of this company being done in the construction of the famous dynamite guns on Fishers Island, New York. He then entered the employ of the Westinghouse Electrical and Manufacturing Company in the main shops of the company at Pittsburgh, with whom he has ever since been identified and in whose service he has established a well-deserved reputation for sterling worth and expert ability. No problem of mechanics evades his wide and practical knowledge, no process so involved that he is unable to swiftly comprehend its complicated workings. With his knowledge and ability he couples a capacity for an almost endless amount of work, and is one of the most trusted and best regarded men in the company's plant, which is of mammoth size. He married Elizabeth, daughter of Samuel P. Harris, a wholesale and retail merchant of Darlington, England. She died in 1901, aged fifty years. Children: John F.; Samuel F., of whom further; Ernest and Ewart, all of Scranton; Harry, a resident of Carbondale; and Anna, married John F. Gibson, now living in Birmingham, Alabama.

Samuel F. York, son of William F. and Elizabeth (Harris) York, was born in Darlington, England, December 10, 1874. His early boyhood was spent in the city of Scranton and there he attended the public schools. When a young man he learned the printer's trade and soon after completing same started in independent operations as the York Printing and Publishing Company. Establishing a reputation for high class work, especially book and magazine printing, his business rapidly grew until it was the largest of its kind in the city. A great deal of job work was also handled at the shop, which continued a flourishing career until 1906, when Mr. York turned the active management over to others, still retaining his interest in the business. For a time he gave his undivided attention to other interests in southern land companies, conducting later investment and brokerage operations. He is now the accredited representative of a large New York City banking house, in the State of Pennsylvania. His other business connections are as vice-president and treasurer of the Baumeister Drug Company, and treasurer of the Pension Mutual Life Insurance Company. Mr. York is a member of the Good Shepherd Episcopal Church, while his wife belongs to the Emmanuel Baptist Church. He is a thirty-second degree Mason, belonging to Schiller Lodge, Free and Accepted Masons; Keystone Consistory, Sovereign Princes of the Royal Secret, and is a noble of Irem Temple, A. A. O. N. M. S. He is one of the active members of the Temple Masonic Club and is vice-chairman of the Navy League.

He married Bertha, daughter of Herz Lowenstein, an old merchant of Scranton, who established the first department store in the city of Scranton, on what is now Cedar avenue. Children: Warren W. and Gladys H.







*Cyrus D. Jones*

## CYRUS D. JONES

Many men pass from mortal view and are only remembered through the monument marking their resting place. Others by chance are brought into the public eye through a chance turn of fortune's wheel, while others build a monument of commercial fame that endures forever. To this latter class belongs Cyrus D. Jones, who has seen the company he founded grow to such proportions that the sign, Grand Union Tea Company, is found in all the cities of our country. He has seen it safely weather every financial storm, and emerge from each larger, better and stronger. Such a monument, built only by unceasing industry, careful judgment and wise executive ability, when built, is one to be proud of, and one worthy of being used as an example of what can be accomplished by well directed and honorable effort.

A glance at the ancestry of the men of nerve, wisdom and energy who have accomplished so much, reveals the fact that their forbears were men of courage and enlightened minds and that Cyrus D. Jones comes rightfully by his pioneer spirit and owes much to the sturdy ancestors who revolted against kingly oppression and helped to found a nation in a new world.

Colonel John Jones, the English ancestor, was governor of Anglesea, member of parliament from Wales, colonel in Cromwell's army and one of the court of judges who decided the fate of Charles I. of England. When Charles II. ascended the throne, he pardoned many who aided Cromwell and his cause, but the members of the court that tried and sentenced his father to death, he never forgave, but pursued them to the grave. Colonel Jones married a sister of Oliver Cromwell, and his son, William Jones, a barrister of London, came to America with two of the regicide judges, Whalley and Goffe, assisting in secreting them from the King's officers who were in close pursuit. The record states that Whalley and Goffe were conducted by Jones and his friends "some three miles into the wilderness beyond the mill, where a booth having been constructed, the party spent the night."

Deputy-Governor William Jones, the American ancestor, was born in London, England, in 1624. He married, July 4, 1659, Hannah, daughter of Theophilus Eaton, governor of the colony of Connecticut. He came to America with his wife and two sons, William (2) and Nathaniel, locating at New Haven with his father-in-law, Governor Eaton. In May, 1664, he was chosen deputy-governor of the colony, and had a church seat on "the long seat" with other men of distinction. Isaac Jones, youngest son of Deputy-Governor William Jones, was born in New Haven, Connecticut, June 21, 1671. He settled in Stratford, Connecticut, and there married Deborah Clark. Isaac (2) Jones, sixth child of Isaac (1) Jones, married and had a son John, who married and had a son Josiah, who married Sarah Smith. Their son, Isaac (3) Jones, was born at Stamford, Connecticut, November 11, 1794, and married Lois Curtis. Their eldest son, Isaac S. Jones, was born in Stamford, Connecticut, there became a merchant, represented his town in the state legislature, also filled various local offices. He married Frances J. Weed, of Pound Ridge, New York; children: Frances S., Mary E., Frank S., Cyrus D., Charles F. While the three sons of Isaac S. Jones, Frank S., Cyrus D., and Charles F., at first formed the firm of Jones Brothers, later the Grand Union Tea Company, Frank S. and Cyrus D. Jones, carried the burden longer, Charles F. retiring ere the business assumed its latter day magnitude.

Cyrus D. Jones was born in Stamford, Connecticut, May 1, 1852. He attended school, then became clerk in his father's store, later going to New York City, where he clerked in a similar store, and for one year was with J. H. Knapp & Company, a wholesale wood and willow ware house of New York.

In the meantime Isaac S. Jones, the father, had moved his residence to Scranton, where in 1871, he was joined by his son, then nineteen years of age. Cyrus D. Jones attended Gardner's Business College and clerked in Scranton for about a year, then having attained his majority he joined with his brothers forming the firm of Jones Brothers and engaging in the tea business in Scranton. In 1877 they organized as the Grand Union Tea Company and began their wonderful career of growth and expansion. The company, which started so humbly, September 1, 1872, is now one of the mammoth retailing companies of the United States, regularly incorporated with head offices in New York City, has about 200 stores in leading cities, employs an army of over 3000 people and does an annual business of many millions. Of this great company, Cyrus D. Jones is vice-president, a position he has held since its formation. He and his brother, Frank S., trading as an individual firm, purchase all the products, premiums, etc., used by the company, importing whole cargoes of tea and supplying the capital for the importation of the immense quantities of coffee annually sold by the company. The brothers also own the Anchor Pottery of Trenton, New Jersey, the Grand Union using the most of the output of that pottery. Charles F. Jones, the third brother, retired in 1893. While the Grand Union Tea Company, as at present conducted, is a vast, well regulated machine that is almost automatic in its workings, it was not always so, and while success in its fullest sense has crowned the efforts of the brothers, the result was not attained without the hardest kind of work and the incessant exercise of all the best merchandising qualities of the founders.

During its business life of forty years the Grand Union has passed safely through financial crises, weathering storms that have left the country strewn with the wrecks of much more pretentious concerns. The company has so wisely conserved its resources that in times of national financial stringency it has been able to extend instead of curtailing its operations. The history of these operations is as interesting and almost as dramatic (but happily less tragic) as the scenes the Jones ancestors passed through, when with parliament they fought their King. When the first start was made in 1872, the brothers made a house to house canvass for orders, and were obliged to deliver on foot until sufficient means had been accumulated to afford wagon delivery. Frank S. Jones was the first president of the company, which was not incorporated until 1893, continuing its head until 1903, when he was succeeded by W. J. Burke. The home office in New York City, (borough of Brooklyn) covers an entire block and is devoted entirely to the manufacture and shipping interests of the Grand Union Tea Company. It contains a plant for the manufacture of paper bags, another for making tin cans, a well equipped soap factory and a complete printing establishment.

In addition to the conspicuous part he has ever played in the affairs of the Grand Union Tea Company, Cyrus D. Jones holds important official position in over thirty other corporations and firms, including the presidency of the People's Bank of Scranton, the vice-presidency of the United States Lumber Company and a directorship in the Traders' Bank of Scranton, also on the executive board of Scranton Trust Company. But these interests, weighty as they are, have been voluntarily laid aside so far as active participation in their affairs are concerned, Mr. Jones having determined to limit his personal effort. He has so far adhered to his resolutions that he now lives practically retired, his connection being advisory and voluntary. He maintains his beautiful home in Scranton at No. 901 Olive street, and without ostentation is a liberal benefactor of the charitable and philanthropic institutions of his city. Travel is his chief relaxation and in pursuit of recreation and knowledge he has traversed Europe and America. His rare and genial nature has endeared him to a wide



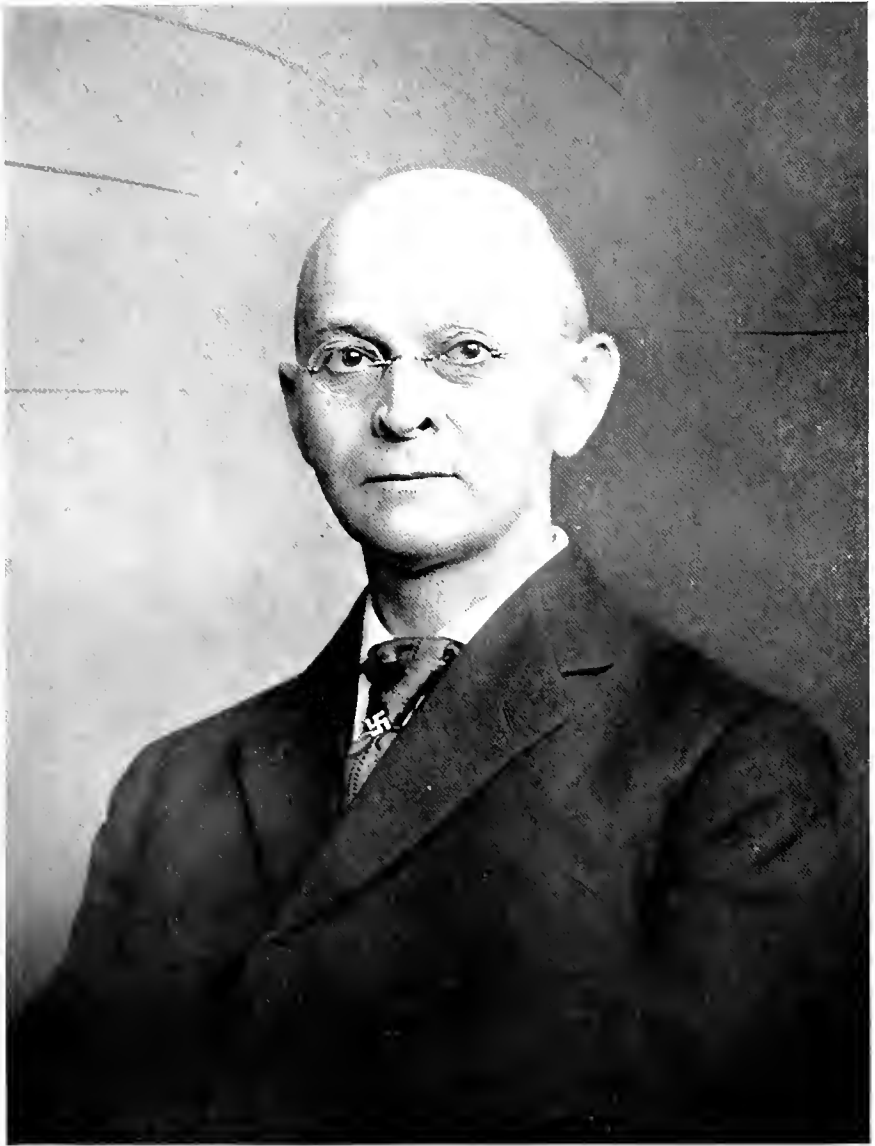

S. P. Markimo.

circle of friends to whom the charming hospitality of his home is freely extended. Mr. Jones is a member of the Elm Park Methodist Episcopal Church, and president of the board of trustees. He has ever been a friend of the Young Men's Christian Association of Scranton and was a strong pillar of support, financially, in the erection of its magnificent building.

Mr. Jones married, March 23, 1876, Mary S. Horn, of Scranton. Children: 1. Arthur A., president of the Grand Union Tea Company; married Ellazena Bixby; resides in Brooklyn, New York. 2. Harry L., connected with the Grand Union Tea Company as treasurer; married Edna Caryl; resides in Brooklyn. 3. Helen F. 4. Frederick B., a banker and broker, Bank of Scranton.

---

#### DANIEL R. WATKINS

Among the earliest settlers of Carbondale, Pennsylvania, was Edward Watkins, grandfather of Daniel R. Watkins, of this narrative, who came to the United States in 1826 from Breconshire, Wales, where he followed the occupation with which he had been identified in his native land, that of a miner. His last years were spent with his son, Thomas E. Watkins, at whose home his death occurred in 1879, when he was seventy-five years of age.

(II) Thomas E. Watkins, son of Edward Watkins, was born in Carbondale, Pennsylvania, in 1828. His earliest employment was in the mines and all his life was spent in work connected with mining, mine foreman having been his position for many years before his death, on October 14, 1889, aged sixty years. In 1859 he moved to Scranton and was there employed for the last half of his life in the coal mining department of the Delaware, Lackawanna & Western. He was a prominent member of the Tabernacle Congregational Church, to which his wife also belonged, and held a place on the board of trustees. His fraternal affiliation was with the Independent Order of Odd Fellows. He married Rachel Lewis. Children: William E., a resident of New York City; George W. (deceased); Daniel R. (of further mention).

(III) Daniel R. Watkins, son of Thomas E. and Rachel (Lewis) Watkins, was born in Yorktown, Carbon county, Pennsylvania, December 10, 1857. He was excellently educated in the public schools, Wyoming Seminary, and the Collegiate Institute, of Newton, New Jersey. His father was proprietor of a general store in Hyde Park, although he did not give it his personal attention, and Mr. Watkins entered the store as manager, sharing the duties of the position with his brother, W. E. Watkins, the two conducting the business of the store until 1876. He was then employed in the hosiery department of the Boston Store for two years, in 1878 going to Philadelphia with Martin Maloney to accept a position with the Penn Globe Gas Light Company. Two years also covered his period of service with this company, after which he became a bookkeeper in the employ of Samuel Stetler, at Duryea. In 1882 he returned to Scranton and became the partner of E. C. Dimmick, engaging in the hardware business. At the dissolution of this partnership, on February 22, 1886, he again became a bookkeeper this time in the service of T. J. Kelly & Company. In 1895 he took a much needed rest from business, his health having been poor for some time. Since 1897 he has been connected with the department of city assessors and since the present administration came into office has been president of the board.

Mr. Watkins married Miss Stella Josephine Platt Himrod, daughter of W. G. Himrod, of Trumansburg, New York. Children: Thomas Brunson, a resident of Buffalo, New York, and William E., living in Scranton.

## JONATHAN M. WAINWRIGHT, A. B., A. M., M. D.

Wainwrights of the branch of which Dr. Jonathan M. Wainwright, A. B., A. M., M. D., is a descendant, claim no very long residence on this side of the Atlantic, the first member of this branch of the family to settle in this country being Peter Wainwright, an English merchant, who made his home in Boston shortly after the Revolution. Since that time the family has been represented in ecclesiastical pursuits by one of the most saintly of divines, the Rev. Jonathan Mayhew Wainwright, bishop of the Episcopal Diocese of New York, well known for his labors in the general convention preparing the standard edition of the Book of Common Prayer, grandfather of Dr. Jonathan M. Wainwright, of this narrative. Among his sons were: Jonathan Mayhew, who attained the rank of commander in the United States navy, and William Augustus Muhlenburg, father of Dr. Jonathan M. Wainwright. Dr. William Augustus Muhlenburg Wainwright was a noted physician and surgeon, and made as valuable contributions to medical, as his revered father had to ecclesiastical literature. In his half century of life he gained wide distinction in his profession and was at one time president of the Connecticut State Medical Society. His death occurred in 1894.

Dr. Jonathan Mayhew Wainwright, son of Dr. William Augustus Muhlenburg and Helena Barker (Talcott) Wainwright, was born in Hartford, Connecticut, February 20, 1874. He bears the names that were those of his grandfather and uncle, and have been borne nobly by at least two generations, one carrying it in priestly state in the paths of peace, the other bearing it to a grave found in the service of his country and in defence of her honor. He studied, preparatory to college entrance, at the Hartford High School, and was graduated A. B. from Trinity College in the class of 1895. Attracted by the profession of his father, he entered the College of Physicians and Surgeons, connected with Columbia University, to prepare therefor, and was graduated M. D. in 1899. He was interne in St. Luke's Hospital of New York City for a period of eighteen months, and in 1891 came to Scranton to accept a position as surgeon-in-chief of the Moses Taylor Hospital. This is his present title and while his duties in connection with this institution demand a great deal of his time and attention, he nevertheless maintains a large and lucrative private practice. One of his professional connections is as chief surgeon of the Delaware, Lackawanna & Western Railroad. In 1905 his alma mater, Trinity College, conferred upon him the degree A. M. It was at this institution that he became a member of the I. K. A., a secret fraternity of the college. He is also a member of the County, State and American Medical societies. With his wife he is a member of St. Luke's Episcopal Church. Dr. Wainwright's military career began in 1892, when he became a member of Company F, First Regiment, Connecticut National Guard, as a private, later becoming corporal on the regimental staff, a rank he held for one year. He was then promoted to the grade of first lieutenant, discharging the duties of paymaster, and held that rank for four years. When, at the outbreak of the Spanish-American War, his regiment enlisted as the First Regiment Connecticut Volunteer Infantry, he received a commission as captain. The First Connecticut, though not in active service, was held "in readiness" at Camp Alger, Falls Church, Virginia, where he served as adjutant of the regiment, also as acting assistant adjutant general of the First Brigade, Third Division, Second Army Corps. At the end of the war he received his discharge from the service. Dr. Wainwright's clubs are the Army and Navy of New York City and the Scranton.

Dr. Wainwright married Jessie, daughter of William E. Hart, of Engle-



wood, New Jersey. Children: Jonathan Mayhew, Talcott, Grosvenor, Ruth Wyllys.

A progressive and efficient exponent of modern methods and practices in surgery, Dr. Wainwright has a record of proud attainment, and a reputation as an honorable and conscientious practitioner, brilliant promise of future achievement in the profession which he so worthily represents.

---

#### JUDGE ALTON A. VOSBURG

The Vosburgs of Wyoming county, Pennsylvania, descend from the Dutch settler, Abram Pieterse Vosburg, one of four brothers who settled on the Hudson river prior to 1651. The family were early settlers in Washington township, Wyoming county, Pennsylvania, where they are remembered by Vosburg's Creek and Vosburg Station.

(I) Stephen Vosburg, grandfather of Judge Vosburg, was the first of this direct line to settle in Scott township, (now Lackawanna county) he coming from Wyoming county, where he was born about the year 1800. He came to Scott when a young man, was a farmer and there died about 1870. He married Nancy Brown, born in Scott.

(II) Merritt B. Vosburg, son of Stephen and Nancy (Brown) Vosburg, was born in Scott township, Pennsylvania, in 1842, died July 13, 1913, buried in Scott Valley Cemetery. He was educated in the public school and became a prosperous merchant of Montdale, finally retiring and spending his last years free from business cares. He was a man of alert mind and sterling character, these qualities being recognized by his townsmen and utilized for the public good. He served for many years on the school board and as justice of the peace for five years. He was held in high regard by a very large circle of friends, among whom most of the years of his long life were spent. He was a Republican in politics, and a member of the Masonic Order. Squire Vosburg married Sarah Washburn, daughter of Dexter Washburn, of Susquehanna county, Pennsylvania; she is now deceased. Children: Alton A., of whom further; Bernard V., of Scranton; Clara. The parents and children were members of the Baptist church.

(III) Judge Alton A. Vosburg, eldest son of Merritt B. and Sarah (Washburn) Vosburg, was born in Scott township, (now Lackawanna county) Pennsylvania, April 28, 1865. He was educated in the public schools and Keystone Academy of his own county, then entered the National University at Lebanon, Ohio, pursuing a course in law at the latter institution. He taught school for several terms during the course of his youth, and prior to completing his preliminary law studies with Gunster & Welles, of Scranton. He was admitted to the Lackawanna county bar in 1887, practiced in Scranton alone until 1888, then formed a partnership with W. S. Huslander, an association that continued until 1896. He then became the law partner of C. W. Dawson, which continued until Mr. Vosburg was appointed judge of the Orphans' Court at the time of its establishment in 1901. He remained on the bench until the first Monday in January, 1903, then resumed private practice. In his quarter of a century Mr. Vosburg has enjoyed a large practice, both civil and criminal in the state and federal courts of the district, to all of which he has been admitted. Notable cases with which he has been connected are: Dickinson, versus G. B. Thompson, in which he represented the defendant in the United States Court; the Waverly Bible School case; and the City of Scranton, versus Koehler, which was carried to the superior and supreme courts. He was elected city solicitor in 1898, serving two years until the office became appointive under the "Ripper Bill." In political faith he is a Republican, has

been a member of the county committee for twenty-five years, and for two terms was county chairman. In religious faith he is affiliated with the Providence Presbyterian Church, which he has served as trustee. He belongs to many fraternal orders, including: Hiram Lodge, Free and Accepted Masons; all bodies of Keystone Consistory, Ancient Accepted Scottish Rite; Lincoln Lodge, Independent Order of Odd Fellows, of which he is past noble grand; Scranton Encampment, Independent Order of Odd Fellows; Daughters of Rebekah; past district deputy grand master, Pennsylvania Independent Order of Odd Fellows; Junior Order of American Mechanics, and the Patriotic Order Sons of America. His club is the Scranton. Honored in his profession as a learned and skillful exponent and strong in the confidence of his townsmen there is surely a future of still greater usefulness awaiting Judge Vosburg.

Judge Vosburg married, in December, 1895, Belle Thomas, daughter of William G. Thomas, a well known and respected resident of Scranton. They have a son Floyd.

---

#### FREDERICK A. WAGNER

For nearly a half a century the Scranton Wochenblatt has been one of the most widely read of German-American newspapers in the Lackawanna Valley and during its long existence as the standard of German newspapers has been closely linked with the name of Wagner, the periodical having been founded by father and continued by son. Both have held to a lofty plane in all departments, both have striven for the ideal newspaper of reliability and quality, the Wochenblatt representing their years of effort toward an agent of intelligence free from the contamination of sensationalism or yellow journalism.

Frederick Wagner was born in Anweiler, Bavaria, December 24, 1838, died June 29, 1913. His father, Joseph Wagner, brought him to the United States when a youth, the family settling first at Pittston and later moving to Wilkes-Barre where the family resided at the beginning of hostilities between the North and the South. Both father and son enlisted in the Union army, the younger, Frederick, never being called into service. His father, however, became a member of a regiment of cavalry and was in General Sherman's army in its historic march, immortalized in song, from "Atlanta to the Sea." Frederick Wagner learned the printer's trade early in life and for a time was employed as foreman in the shop of Robert Bauer in Wilkes-Barre, where was published the Luzerne County Wachter. At the close of the Civil War he took up his residence in Scranton and there, in 1865, founded the Scranton Wochenblatt, of which he was proprietor until his death, although for several years previous to that his son, Frederick A., had been in direct charge of the business.

A strong supporter of the principles of the Democratic party, it was Mr. Wagner's nature to labor earnestly in the cause of an able, deserving candidate and to refuse all nominations for himself. Only twice was he brought before the public in the role of one seeking political preference, the first time in 1882, being made a member of the board of poor directors elected by popular vote. The elections were never confirmed, however, for before the newly elected members of the board had entered upon the duties of their office, the state's courts declared the law allowing the election unconstitutional and invalid, the appointment of the board being performed by the courts. His other candidacy was unsuccessful, when, several years later, he was the nominee of his party for city treasurer.

Until a few years before his death Mr. Wagner was a conspicuous figure

in fraternal organizations. His was the honor of founding and being the first president of the German-American Alliance of Lackawanna County, whose president emeritus he was at the time of his final summons. He also belonged to Schiller Lodge, No. 345, F. and A. M., and Roaring Brook Conclave of Heptasophs. During his day of most active participation in business affairs Lackawanna and Penn avenues were the business centers of the city and it was he who erected the first store on Spruce street, opposite the site now occupied by the Hotel Jermyn, and attracted to that locality many of the commercial houses that now make it their home. In the seventy-five years of his busy and useful life, forty-eight were spent in the city of Scranton, excepting two years, when he was in Elmira, New York, publishing the Chemung County Journal, a German newspaper.

He married Elizabeth Hausam, and is survived by her. Children: Frederick A., of further mention; John U., a professor in the Scranton High School; Dr. Joseph A.; Anna, married William Morrow; Ida E.

Frederick A. Wagner, eldest son and child of Frederick and Elizabeth (Hausam) Wagner, was born in Wilkes-Barre, Luzerne county, Pennsylvania, February 14, 1864. He obtained his education in the public schools of Scranton, and later at Elmira, New York, whither his father had moved to publish a German newspaper. He learned the printer's trade under the preceptorship of his father and all his life has been connected with the Scranton *Wochenblatt*. When his father laid down the reins of control in April, 1890, Frederick A. assumed charge of the business and has since continued it, holding to the course that was ever that of his lamented father, one of uprightness and honor in all journalistic affairs. His only other business relation is as director of the Artisans' Building and Loan Association, of which he has been vice-president and is now a director. Mr. Wagner is a member of Schiller Lodge, No. 345, F. and A. M., the Scranton Liederkrantz, the German-American Alliance, and Heptasophs.

Mr. Wagner married Minnie Ailen, of Roxbury, New York. Children: Frieda E., Mabel J., Ralph, Grace A., Herbert J. That Mr. Wagner is a worthy successor of his honored father is proven by the popularity of the journal he publishes. Fitted by experience, in life's prime, and in an age when newspapers are a vital force and potent factor in moulding public sentiment, his is a great opportunity to stand for the best in our modern day existence, cleanliness in social, honor in business, and purity in political circles.

---

#### WILLARD MAINE BUNNELL

The Bunnell family of which Willard M. Bunnell, of Scranton, is representative, came to Pennsylvania in 1766, Solomon Bunnell, of the fourth American generation, being the original settler of the family in Pennsylvania. He was a great-grandson of William Bunnell, the emigrant ancestor who came with his brothers, Solomon and Benjamin, from Cheshire, England, in 1638, settling at New Haven, Connecticut. William Bunnell sprang from the Norman Knight, William La Bunnell, who came to England with William the Conqueror in 1066. From 1638, the date of emigration to America, the Bunnells gained in numbers to such an extent that in 1790, the date of the first national census, they were found in every one of the original thirteen colonies. The record of the family is thus told by their historians: "Being without exception men of character and piety, who used every opportunity to promote education and religion and were the first to adopt a written constitution and to refuse compensation for public service."

Four generations of the family, William (I); Benjamin (II); Benjamin

(III) lived in Connecticut; Solomon (IV) leaving there in 1740, settling at Kingwood, New Jersey, and in 1760 continuing his migration to Pennsylvania, settling in Middle Smithfield, Bucks county, now Monroe county.

(IV) Gershom Bunnell, also of the fourth generation, son of Benjamin Bunnell (III) and brother of Solomon Bunnell, the first of the family in Pennsylvania, lived and died in New Haven, Connecticut. He married, in 1728, Margaret Johnson.

(V) Joseph Bunnell, fifth of the thirteen children of Gershom Bunnell, was a soldier of the French and Indian War and also fought in the Revolutionary army. He married Abiah Kirby, as patriotic as himself, she being one of the women of Litchfield, Connecticut, who melted the leaden statue of King George into bullets for the American troops. During her husband's absence in the army, an Indian attack was so feared that for several nights she carried her young children to a nearby field of rye, for additional safety, if such it might be called.

(VI) James Bunnell, son of Joseph Bunnell, the Revolutionary soldier, died in Bridgewater, Pennsylvania, August 5, 1841, at the home of his son Elijah, and was buried on the latter's homestead, now owned by Willard M. Bunnell, where a suitable stone marks his resting place. He was a blacksmith and spent most of his life in Connecticut, only spending his latter years in Pennsylvania. He married, in 1797, Azuba Carter, born in Susquehanna county, Pennsylvania. Children of James and Azuba Bunnell settled in Pennsylvania, New York, Connecticut, Massachusetts and Tennessee.

(VII) Elijah Bunnell, third child of James Bunnell, was born January 6, 1803, died September 20, 1873. He was the grandfather of Willard M. Bunnell and the first of his immediate family to settle in Pennsylvania, coming from Connecticut to Bridgewater, Susquehanna county, in the spring of 1833. He erected a suitable dwelling as soon as possible on his farm, now the property of his grandson, Willard M. Bunnell, and used by the latter as a summer residence. Elijah Bunnell was the perfect type of a pioneer, sturdy, strong and a noted hunter. In the spring of 1873 he visited his daughter, Lucy J. Rogers, in Lawrence, Kansas, was there stricken with a fatal illness, died and is there buried. He married Lucy Stone, daughter of Apollos and Eunice (Throop) Stone, of Litchfield county, Connecticut, and two of their six children died young.

(VIII) William Bunnell, second son of Elijah Bunnell, was born in Connecticut, February 27, 1829, died February 7, 1898. He was four years of age when his parents settled in Bridgewater, Pennsylvania, where he obtained a good education, finishing under the instruction of Dr. Lyman Richardson, of Hartford, Pennsylvania, a noted early educator. Mr. Bunnell taught school, but from 1854 to 1858 was engaged as salesman, making several trips through the southern states. After his marriage he engaged in farming and merchandising, and in 1881, with two partners, established the National Record, at Montrose, Pennsylvania, which they edited as the organ of the Greenback party. He was one of the founders of Montrose Grange, Patrons of Husbandry, was one of the promoters of the Montrose branch of the Lehigh Valley Railroad and throughout his entire life was a useful and public-spirited citizen. He married, December 21, 1858, Mary Jane Maine, daughter of Isaiah and Polly May (Williams) Maine.

(IX) Willard Maine Bunnell, youngest of the four children of William and Mary Jane (Maine) Bunnell, was born at Dimock, Susquehanna county, Pennsylvania, January 14, 1874. He obtained his early education in the public school and prepared for college at Keystone Academy, Factoryville, Pennsylvania. He then entered Bucknell College, whence he was graduated B. A.,



Wm Russell



class of 1897. Deciding upon the profession of law, he began legal study in the law offices of Willard, Warien & Knapp at Scranton, continuing until after passing the required examinations; he was admitted to the Lackawanna county bar, February 1, 1899. He has since then been engaged in the practice of his profession, in the public service, and as vice-president and trust officer of the Anthracite Trust Company of Scranton. He was elected in 1906 prothonotary of Lackawanna county, serving with such acceptability that in 1909 he was elected for a second term of three years, enjoying the distinction of being the only Democrat ever elected to that office in the county.

Mr. Bunnell, aside from his professional and official duties, has always found time for social, philanthropic, fraternal and club activities. He is a member of a number of German and other singing societies, being himself gifted with fine musical ability. He is also a member of St. Luke's Protestant Episcopal Church, and a director of the Young Men's Christian Association, an institution of which Scranton is justly proud, theirs being the finest building owned by the association in the state, also a director of the board of associated charities. He is also a trustee of Keystone Academy and gives these institutions a great amount of his time and best effort. He holds active membership in Peter Williamson Lodge, Free and Accepted Masons; Lackawanna Chapter, Royal Arch Masons; Scranton Council, Royal and Select Masters; Coeur de Lion Commandery, Knights Templar; Irem Temple, Nobles of the Mystic Shrine; James A. Connell Lodge, Independent Order of Odd Fellows; Fairview Lodge, Knights of Pythias; Scranton Lodge, Benevolent and Protective Order of Elks; Knights of the Mystic Shrine, and is lieutenant commander of the Uniform Rank Patriotic Order Sons of America. He is president of the Automobile Association of Scranton and thoroughly enjoys the delights of touring the rural regions of his section and state. The foregoing gives one an idea of the all around activity of Mr. Bunnell. Diligent in business, he yet fulfills all his obligations as a citizen and neighbor; is popular with his friends "whose name is legion," and stands as a true type of virile American manhood.

Mr. Bunnell married, December 1, 1897, Margaret Irene Walls, daughter of George W. and Ventilia Irene (Snyder) Walls, of Lewisburg, Pennsylvania, and is a great-granddaughter of Simon Snyder, former governor of the State of Pennsylvania. She descends from patriotic ancestors and holds membership in Shikillemy Chapter, Daughters of the American Revolution, of Lewisburg. Children: William Kirby, died in infancy; Walls Willard; Philip Wolfe.

The summer home of the Bunnells is the old Bunnell homestead near Montrose, which Willard M. Bunnell purchased from his sister who inherited it from her paternal uncle, Kirby Bunnell. The farm is the meeting place of the Bunnell clan, who there gather in great numbers in annual reunion. Their city home is at No. 410 Clay avenue, Scranton.

---

#### LEWIS B. CARTER

Three generations of Carters have been born in West Auburn township, Susquehanna county, Pennsylvania, descendent of Hiram Carter of Connecticut, great-grandfather of Lewis B. Carter, the able lawyer and successful real estate dealer of Scranton. Hiram Carter came from Connecticut, about the year 1800, and was one of the earliest settlers in South Auburn where he cleared, planted and hunted. He was a famous hunter, the many wild creatures then inhabiting the forest giving him abundant opportunity to display his skill. He carved a farm and home from the wilderness and, although his many chil-

dren were cradled in a bed hewn from a sap log, they grew up sturdy and self-reliant, worthy pioneer sons and daughters.

(I) Daniel Carter, son of the pioneer, was born in Auburn township, one of a family of seven sons and two daughters. He lived the early life of a pioneer boy and spent his life in his native township, becoming a farmer and landowner.

(II) Griswold Carter, son of Daniel Carter, was born in Auburn township, August 11, 1841, died April 1, 1904. He was a farmer all his life, an active member of the Patrons of Husbandry, and a landowner. He was a man of bright intellect and education, mingling prominently in township affairs, serving as school director, poor commissioner and township auditor. He was a prominent member of the Methodist Episcopal Church, which he served in official capacity. He was also a member of the Independent Order of Odd Fellows. He married Susan N., daughter of Daniel N. Seeley, of Brooklyn, Susquehanna county, Pennsylvania.

(III) Lewis B. Carter, son of Griswold and Susan N. (Seeley) Carter, was born in Auburn township, Susquehanna county, May 4, 1870. He grew to youthful manhood at the home farm obtaining in the township schools, a good public school education. He taught school for four winter terms in his native county, then entered State College, working his way through, not only paying his own expenses, but leaving college with a surplus. He was honor man of his class and was graduated B. S., class of 1896. Having finished his classical course with honor he at once began the study of law, first under the direction of Watson & Zimmerman, later under Willard, Warren & Knapp of Scranton. He was admitted to the Lackawanna county bar, August 14, 1899, and at once established an office in Scranton, devoting himself to general practice and so continuing until 1903, since which date he has made a specialty of the law of corporations and real estate. At the same time he began the extensive promoting and real estate operations that have placed him foremost among the leaders in that field. During the years 1903-1905, he promoted the Scranton, Factoryville and Tunkhannock Railroad, which later was merged with the Northern Electric Railroad; the Sunbury and Selinsgrove Electric Railway and the Summit Land Company, a very successful company, handling the Clark's Summit tract and other suburban property. Of this latter company, Mr. Carter is secretary. In 1908 he financed and built the Luther Apartment House; in 1910, 1911 and 1912, the Carter Apartments of twenty-four suites in main building; in 1913, the Carter Apartments Annex of three suites and store. In the spring of 1913, Mr. Carter formed with Andrew R. Muir the firm of Carter and Muir, to conduct a law, real estate and insurance business, of which firm he is the senior member. In December, 1913, his firm financed and promoted the Black Walnut Poultry & Stock Farms Company at Black Walnut, Pennsylvania, also Walnut Park, a fine summer resort at Black Walnut, Pennsylvania. An indefatigable worker with keen business instinct, mind and body ever alert, the success of Mr. Carter, while phenomenal even in Scranton, is not a matter of surprise. The qualities he possesses must ever win, when backed by a clean life and an honest ambition. Whether he be considered as lawyer, promoter or business man, he meets every requirement and the future holds for him nothing but bright promise.

To turn to the military career of Mr. Carter, is to reveal another admirable side to his character. He drilled with the Cadet Battalion five years, closing his senior year as captain of Company D, and in July, 1896, was appointed brevet second lieutenant National Guard of Pennsylvania. When President McKinley called on Pennsylvania for men at the outbreak of the Spanish War, he enlisted in Company A, Thirteenth Regiment, and on April



27, 1898, marched away with the regiment. He saw only camp and marching service at Mount Gretna, Pennsylvania, Falls Church, Virginia, and Camp Young near Harrisburg, but later was sent to Savannah, Georgia, where he was mustered out March 7, 1899. In January, 1901, he reenlisted in Company A, Thirteenth Regiment, National Guard, and on April 4, 1901, was appointed inspector of rifle practice on the staff of Colonel L. A. Watres, with the rank of first lieutenant, serving until 1904. He built up the rifle record of the Thirteenth Regiment to a height that surpassed all other regiments of the guard. He caused to be built a regimental indoor rifle range and an outdoor range at Rocky Glen, and during his official term the rifle team from the Thirteenth won two permanent trophies for excellence of marksmanship in competition, and the title of the champion rifle team of the Pennsylvania National Guard in 1902. This team also took honorable rank in all the United States rifle team matches at Sea Girt, New Jersey. In 1904, Captain Carter's commission expired and he retired from military service. He was one of the organizers and is trustee of General J. P. S. Goebin Camp, No. 41, U. S. W. V. Both he and his wife are members of Elm Park Methodist Episcopal Church, active in the Sunday school, and she in the Woman's Home Missionary Society, of which she is recording secretary. In political faith he is independent.

Mr. Carter married, June 25, 1907, Mae Hughes, daughter of Luther M. Jones, and granddaughter of Benjamin Hughes of the Delaware, Lackawanna & Western Railroad, through whose efforts so many Welsh emigrants were brought to settle in the Lackawanna Valley. Mr. Carter's home, No. 331 Colfax avenue, erected by Mr. Carter in 1907, is one of the many fine residences of Scranton.

---

#### CHARLES HARVEY POND

The eighth generation of a famous New England family, whose members were among the earliest in Connecticut, and whose immigrant ancestor was one of the first settlers of Windsor, Connecticut, Charles Harvey Pond, of Scranton, belongs to one of the oldest families in the country.

The only son of Alvin Porter and Emeline Thirza (Clark) Pond, was born at Southington, Connecticut, December 15, 1847. He attended the public schools of his native town and Lewis Academy, also located in Southington, and when eighteen years of age began his business career in the employ of the hardware firm of George B. Curtiss & Company, of New York. In 1868 he was employed at Bristol, Connecticut, in the interest of the same company, and in February, 1869, returned to the place of his birth in the service of the Aetna Nut Company, as bookkeeper and secretary, holding this position until 1873, when he went to Ohio in the employ of the Gerard Rolling Mill Company at Gerard, Ohio, and in 1874 became the junior member of the firm of Taylor, Mitchell & Pond, at Massilon, Ohio, manufacturers of merchant iron and "T" rails, both traveling in the interests of the firm and also attending to the office routine.

After five years he again returned to Southington and was employed by J. B. Savage for the manufacture of forgings. The seat of the business was removed to Scranton in 1887, because of the greater advantages in the way of fuel and shipping facilities, and was incorporated as the Scranton Forging Company. The factory was supplied with the most modern of appliances in the way of equipment, drop and trip hammers, which were installed, accomplishing work formerly done by hand. The first official arrangement was with Mr. Savage as president, and Mr. Pond, secretary and manager of the company, but in 1890, Mr. Pond succeeded to the presidency and has since been

the head of the corporation, which has increased in size and importance until it is now one of Scranton's prominent and flourishing industries. In addition to the business of his founding, Mr. Pond is financially interested in various other corporations, and holds position upon the directorates of several institutions and organizations, among them the North Scranton Bank. He is active in the councils of the Scranton Board of Trade, and is a member of the Green Ridge Club, also belonging to the New England Society of North-eastern Pennsylvania, of which he is ex-president. For twelve years he was treasurer of the Green Ridge Presbyterian Church, and for many years was a trustee of the same, of which he is still a member. His political faith is Republican.

A successful business man, Mr. Pond does not confine himself so closely to the relations of business but that he finds time to discharge the duties of a good citizen. He is a prime factor in all the projects of the board of trade and otherwise labors to add to the prosperity of the city that he has made his home, and which, by the advantages it offers, has added so materially to his prosperity.

Mr. Pond married, December 15, 1874, Harriet I. Finch, born at Southington, Connecticut, December 16, 1850, daughter of Samuel H. and Helen (Lee) Finch. Children: 1. Harry Orlo, born at Massilon, Ohio, October 15, 1875; associated with his father in business; married, October 5, 1911, Helen M. Heimbach, of Scranton. 2. Charles Wilcox, born at Southington, February 4, 1879, died January 24, 1900, in Scranton.

---

#### CHARLES H. WELLES

Charles H. Welles is a descendant of the old Welles family of Connecticut, and the pioneer Gay family of the Wyoming Valley, Pennsylvania, and son of Charles H. and Sarah (Gay) Welles.

Charles H. Welles Jr. was born in Dundaff, Susquehanna county, Pennsylvania, April 16, 1845. He obtained his preliminary education in the public schools and his final academic instruction at Luzerne Institute at Wyoming, although his studies of a legal nature continued for some time thereafter, first under Samuel Sherrerd, of Scranton, and finally in the office of Hand & Post. His admission to the bar of Lackawanna county was granted, after a successful examination in February, 1867, and to that of Luzerne county in the following month. His practice has always been in Scranton. In 1869 he became clerk of the mayor's court. The law firm of Welles & Torrey, of which he is the senior member, was organized in 1868, the junior partner being James H. Torrey, an eminent legal light. The firm continued to the present time, although three of their sons have been admitted as partners, the partnership now comprising a quintet of Welles and Torreys, one of the best reputed firms in the region, supplying the legal needs of a large practice.

Mr. Welles has confined himself exclusively to civil practice, being minutely exact in his knowledge of legal precedent and processes. He has been admitted to all the state and federal courts of his district and is a member of the County and State Bar associations. His religious connection is with the Second Presbyterian Church, and in its organization he fills the position of elder. A lawyer of high reputation and a churchman of recognized worth, Mr. Welles is also keenly alive to the needs and requirements of this city, meeting his share of the burden with the willingness of a good citizen.

Mr. Welles married, October 20, 1866, Hannah B. Sherrerd. He has four children, the second, Charles H. (3), a member of the firm of Welles & Torrey.

## FREDERICK WILLIAM WOLLERTON

Although not a native born son of Scranton, Mr. Wollerton is identified with important financial institutions of the city and is one of her loyal friends and supporters. He comes from a Chester county family, adherents of the Society of Friends, they coming to that county from the town of Hicklin, Nottinghamshire, England, at a date not fixed. The first marriage of record in the family was of Charles Wollerton, who married Jane Chilcot in Concord Meeting, 3rd mo. 18 day, 1726. The line of descent is through their son John, his son William (1) to William (2), father of Frederick W. Wollerton.

William (2) Wollerton was prominent in the public and business life of Chester county. In 1851 he was elected prothonotary of the county, and in 1856 Associate Judge, serving in both positions with honor. In business life he was best known as the able president of the First National Bank of West Chester, one of the solid financial institutions of the county. He married Olivia Work, who died in 1891; he surviving her until 1898.

Frederick W. Wollerton, son of William (2) and Olivia (Work) Wollerton, was born in West Chester, Pennsylvania, August 24, 1854. He began business life as office boy in the First National Bank of which his honored father was president and passed through every grade of service in that institution until finally he became cashier. In 1902 he resigned to accept a similar position with the Traders' National Bank of Scranton, later resigning that office to aid in organizing the Union National Bank of the same city. He was chosen its first vice-president and cashier, holding this dual office until he laid down the latter, now (1914) being vice-president and member of the board of directors. He is also a director of the First National Bank of Factoryville, director of the Old Forge Discount and Deposit Bank, director of the Scranton Life Insurance Company and of the Scranton and Binghamton Railroad Company. He is independent in political action but a man interested in all that pertains to the public good. He is fond of outdoor life and sports, particularly golf, being one of the enthusiasts of the Scranton Country Club. He belongs to the Scranton Country and Bicycle clubs of Scranton, the West Chester Club of West Chester, the Waverly Country and the Hazleton Country clubs, taking active interest in all.

Mr. Wollerton married Josephine Brinton Thompson, of Philadelphia, and has an only child, Martha Brinton Wollerton.

---

EDWARD J. LYNETT

Edward J. Lynett, editor and proprietor of The Scranton Times, and who has made for himself a notable record in the field of journalism, as head of one of the most influential newspapers of Pennsylvania, was born in Dunmore, Lackawanna county, July 15, 1857.

His father, William Lynett, was born in county Sligo, Ireland, in 1820, and came to America in his sixteenth year. For a time he resided in New York, thence removing to the Dunmore settlement, near Scranton, where he lived upwards of fifty years and until his death. He was a competent and successful mining contractor. A man of good practical education and business ability, he was influential in the community and was called to various public positions, serving as school director and treasurer, and borough treasurer. He was a Democrat in politics, and wielded a potent influence. He married Catherine Dowd, and their children were: Ann, who became the wife of Thomas F. Cawley, of Dunmore; Margaret, who died in infancy; Mary, deceased wife of D. F. Boland, of Scranton; Edward J., of whom further; Catherine, who

became the wife of Thomas N. Cullen, of Scranton; Margaret, unmarried; Ellen, who was a teacher in the Scranton public schools, and died unmarried. William Lynett died in 1891, his wife surviving until November 20, 1896.

Edward J. Lynett was educated in the borough schools and the Millersville State Normal School. His first work was in a coal breaker, but his abilities were soon recognized, and at the age of sixteen he became deputy clerk in the mayor's court, in which position he served acceptably for a period of three years ending with the abolition of the court. He subsequently spent a year in law studies in the offices of D. W. and J. F. Connolly. His predilection, however, was for journalism, in which field he was destined to become eminently useful and successful. Taking employment as a reporter on *The Scranton Free Press*, a Sunday publication, he developed marked ability, and was soon made editor and manager, and served in this twofold capacity until October 10, 1895, when he purchased *The Scranton Times*, of which he has been owner and responsible editor to the present time. On becoming owner, Mr. Lynett devoted all his energies to the development of *The Times*, and its character, circulation and prestige steadily advanced. In 1901 more ample quarters became necessary, and Mr. Lynett erected the present *Times Building*, in which he installed a complete newspaper and job printing equipment, in all respects adequate for every modern need. Beginning with *The Times* when its circulation was a scant three thousand, the smallest of any paper in the city, he advanced it to 40,000 copies, more than that of all other city newspapers combined. Such success affords ample evidence of Mr. Lynett's possession of every quality necessary to a leader in journalism in a peculiarly insistent day—literary ability, integrity of purpose, and business ability. Honest and fearless, even aggressive when need be, he has at all times championed the interests of the people at large, defending them in their rights and earnestly contending for the remedying of their wrongs. His public spirit has constantly been reflected in *The Times* in the initiation and furtherance of various salutary measures and enterprises, and with entire unselfishness he has ever heartily seconded every laudable effort to similar ends, no matter by whom conceived or urged. While the material reward has not been meagre, his greatest pride is, in the true spirit of the conscientious journalist, that he is recognized as the maker of a clean, honest and well appreciated newspaper, the most popular and most liberally supported in the city.

While *The Times* is his first care, Mr. Lynett has given useful personal service to the community in various capacities. He was for three years a member of the Dunmore borough school board; burgess of Dunmore borough for two years; was for thirteen years secretary of the Scranton poor district; member of the mine cave commission, 1911-13; and for several years a director of the Associated Charities of Scranton. He is vice-president of the Dime Savings Bank; president of the Paragon Plaster Company; and is interested in several other industrial and commercial companies. A Democrat in politics, he has attended many party conventions; he was also a delegate from his congressional district in the Democratic national conventions of 1900 and 1908, and a delegate-at-large in that of 1912. He is a communicant of St. Peter's Roman Catholic Church; was a delegate to the National Catholic Congress held in Chicago in 1893; and is connected actively with various societies affiliated with the church—the Catholic Club, Holy Name Society, and the Knights of Columbus. He is also a member of the Benevolent and Protective Order of Elks, the Scranton Press Club, and the Scranton Club.

Mr. Lynett married, September 30, 1896, Nellie A. Ruddy, daughter of Thomas and Elizabeth (Nallin) Ruddy, her father a merchant of Scranton. Children: William R., born September 10, 1899; Elizabeth R., June 23, 1903;

Edward J. Jr., July 25, 1906. The oldest son, William R., is a student at St. Thomas College; the other children attend the public schools.

---

#### EDWARD A. BURKE

The Burkes, old time residents of Pennsylvania, are represented in Scranton by Edward A. Burke, the young, enterprising and capable member of the banking firm of E. A. Burke & Company.

Edward A. Burke is a son of Michael J. and Bridget A. (Fadden) Burke, of Carbondale and Scranton. Michael J. Burke was for many years proprietor of the Eureka House on Diamond avenue, and of the "Palace" on Lackawanna avenue. He died in 1901, aged forty-four years.

Edward A. Burke was born in Chicago, Illinois, September 20, 1882. He came to Scranton when a child with his parents and there has passed his subsequent life. He was educated at the Saint Cecelia Academy, and began business life as a stenographer with I. F. Megargel, the first investment banker to establish an office in Scranton. Mr. Megargel was succeeded in business by his son, Roy C. Megargel, Mr. Burke retaining the same position under the son and his successors, as under the father and founder. He became thoroughly familiar with the investment business, mastering its every intricacy and detail, fitting himself by experience and knowledge to conduct a similar business for himself. In May, 1907, he formed the firm of E. A. Burke & Company, investment bankers, now located in successful business on the ground floor of the Traders National Bank Building. The firm make a speciality of bank stocks and of all northeastern Pennsylvania securities, both stocks and bonds. Mr. Burke has established a reputation among investors as a wise, careful and judicious adviser and holds the confidence of a large clientele of investors. He has been identified with the Northern Electric Street Railway since its inception, assisting the company to finance the road through sale of bonds. The phenomenal success of the road is well known and it has returned substantial profits. He is a member of the Scranton Board of Trade and the Scranton Club, taking active part in both. He has not only built up a good business on solid principles, but has made for himself a host of business and social friends, and is rated one of the rising young business men of the city which has been his home since childhood.

Edward A. Burke married Anna, daughter of J. S. Rambo, of Norristown, Pennsylvania. He has one daughter, Nancy. The family home of the Burkes is at the Florence Apartments.

---

#### JOSEPH A. SINN

The Sinn family is an old one in Pennsylvania, having been seated there for seven generations. The paternal ancestry of the family is German and the name, with precisely the same spelling, persists in the German language to the present time. The maternal ancestry traces to England. Chester county has been the place of residence of all of the name ever since the arrival of the emigrant, Andrew C. Sinn, he being the first of the line to leave the immediate locality when he moved to Philadelphia in 1840 and there established a dry goods business. He continued in this line until he was sixty years of age, when he retired, accepting the presidency of the Merchants' National Bank, of Philadelphia, to which he devoted all of his time and talents during his remaining years. He was a member of the Masonic Order and was past master of Perkins Lodge, Free and Accepted Masons, of Philadelphia. He married Sarah Ann Pierce, daughter of George Pierce, of Chester county, Pennsylvania.

Joseph A. Sinn, son of Andrew C. and Sarah Ann (Pierce) Sinn, was born in Philadelphia, Pennsylvania, October 17, 1854. His preliminary education was obtained in the public schools of Philadelphia and his college training in the law department of the University of Pennsylvania, whence he was graduated LL. D. in the class of 1875. He engaged in the general practice of law until 1866, when he was retained as trust officer of the City Trust Safe Deposit and Surety Company, of Philadelphia, later becoming vice-president of the same institution. In 1900 he was elected president of the Surety Underwriters Association, of Philadelphia, and in that year severed his connection with the former company. His presidency of the Underwriters Association continued until 1908, when he came to Scranton, accepting the vice-presidency of the Title Guaranty and Surety Company and the managership of the Surety department, an office he holds at the present time. Mr. Sinn is a member of the Board of Trade and an earnest advocate of any measures tending toward the ultimate benefit of his recently adopted city. He belongs to the Scranton Club, the Country Club, the Underwriters Club, of New York, and the Union League, of Philadelphia.

Mr. Sinn married Ella T. Wise, daughter of Jacob Wise, of Philadelphia, and has three children: Clarence Wise, of New York City; Francis P., superintendent of the New Jersey Zinc Works at Palmerton, Pennsylvania; Esther M.

---

#### HON. JOHN P. KELLY

The Kellys trace to an ancient Irish ancestry. John Kelly, father of Judge John P. Kelly, was born in county Down, Ireland, and there grew to youthful manhood, coming to the United States when twenty years of age. He was employed by the Lackawanna Iron and Coal Company, at their brick yard in Scranton from 1850 until about 1853, when he established in Olyphant, Pennsylvania, as a brick manufacturer, having thoroughly learned the business from his first employers. He continued in successful business in Olyphant for several years, then moved to Dickson, Pennsylvania, remaining there until 1873, when he moved to Scranton, where he was proprietor of a hotel in Providence for many years. He died in April, 1906, at the age of eighty-one years. In his younger years he took an active part in politics. He married Ella Downey.

Judge John P. Kelly, son of John and Ella (Downey) Kelly, was born in what is now the borough of Olyphant, Lackawanna county, Pennsylvania, January 30, 1862. His mother died when he was young, leaving the care of the lad to his father, who never remarried, and his older brother and sisters. He was educated in the public schools, passing through the various grades and being graduated from Scranton High School, class of 1879. He had formed an ambition for the law, and soon after graduation he entered the law offices of Aretus H. Winton and John B. Collings, as a law student. After thorough preparation he was admitted to the bar of Lackawanna county, April 23, 1883. Soon after his admission he entered the office of John F. Connolly, then district attorney of Lackawanna county. He continued as Mr. Connolly's assistant in the district attorney's office until 1886, when the latter's term expired. They practiced law together, but not as partners, for two years. In January, 1888, Mr. Kelly formed a partnership with Joseph O'Brien, as O'Brien & Kelly, an association that continued until the election of Mr. Kelly as district attorney, and at the expiration of his term he was elevated to the bench. In 1891 he was elected district attorney of Lackawanna county on the Democratic ticket, serving most creditably for one term, being defeated for re-election by the great land slide that swept about every Democrat in

Pennsylvania out of office. He resumed private practice, and as junior of the firm of O'Brien & Kelly, became well known as a learned, aggressive and successful lawyer. He was admitted to all state and federal courts of the district, the firm having important cases in all. Mr. Kelly continued in successful practice until 1900, acquiring high reputation as a learned and able lawyer. On April 14, 1900, he was appointed judge of the Court of Common Pleas, to succeed Judge Gunster, deceased. In the fall of 1900 he was regularly elected judge to serve the full term of ten years. His career upon the bench was an honorable one and continued without interruption until January 1, 1908, when he voluntarily resigned, laying aside his judicial honors to return to the private practice of his profession. He again became a partner of the law firm of O'Brien & Kelly and, has so continued, honored, respected and popular. As attorney he has been connected with many important cases, while as a judge he was called upon to decide many intricate legal questions out of the ordinary. He gained a high reputation for judicial fairness in his hearing of cases and left the bench with the good will and respect of the entire bar. As an advocate he is eloquent and forcible, using his deep knowledge of the law and his powers of oratory with telling effect in his pleadings. He is aggressive in his legal fights, but eminently fair to an opponent, winning his cases by preponderance of evidence and masterly presentation of his carefully prepared attacks and defences.

A lifelong Democrat, Judge Kelly has ever been active in political affairs. In November, 1888, he was the successful candidate of his party for the legislature from the first district of Lackawanna county, serving his full term with honor. He is the father of the bill, which largely does away with contested election cases, and aided in the passage of much useful legislation passed during his term of office.

Judge Kelly married Theresa E., daughter of Daniel B. Brainard, deceased, a one time owner of the Saint Charles Hotel in Scranton. Children: Louise, Marion, Margaret, Elizabeth. The family home is at No. 920 Olive street, the office of O'Brien & Kelly, Nos. 510-515 Mears Building.

---

### JAMES ALBERT LANSING

To James Albert Lansing, the prominent stove manufacturer of Scranton, is accorded the unusual ancestral distinction of a descent of nine generations, both maternally and paternally, from the two races which, more than any others, played a conspicuous part in the development of the American continent, who founded the strongest legal codes, fostered the deepest religious convictions, and built up the most flourishing and permanent communities in the new world—the English and Dutch. The progenitor of the branch of the family of which James Albert Lansing is a member was Gerrit Frederick Lansing, whose father, Frederick Lansing, was a native of the village of Hassel, Province of Overijssel, Holland. He came to America with his six children in 1650, settling in New Amsterdam, then governed by the man so famous in history, Peter Stuyvesant, who, in the exercise of his authority made himself so odious to the colonists that he earned, beside their cordial dislike, the sobriquet, "Peter the Headstrong." A singular trait of family constancy is found in the fact that since the first pulpit of the first Dutch Reformed church in America was set up (an article of church furniture brought from Holland) there has constantly been a Lansing in the consistory of the historic church at Albany, New York, the house of worship attended by Theodore Roosevelt while he was governor of the State of New York and residing in Albany.

The line of descent from the immigrant ancestor of the family to James Al-

bert Lansing is traced as follows: Gerrit Lansing (1), father of Hendrick G. (2), father of Jacob (3), the first of the line on American soil. Jacob Lansing married Helena, daughter of Frans Janse and Alida Pruyn. Their son Hendrick (4), born December 1, 1703, married Annetye, daughter of Isaac and Mayke (Van Nes) Onderkirk, of Kinderhook. At the death of his wife Hendrick married second Metty, daughter of Abraham Onderkirk. Jacob H. (5), third son of Hendrick and Annetye (Onderkirk) Lansing, was born April 4, 1742, died in Watervliet (now Cohoes), New York, February 7, 1826. He married, in 1763, Maria, daughter of Johannes and Helen (Fonda) Onderkirk. William (6), youngest child and only son of Jacob H. and Maria (Onderkirk) Lansing, was born May 12, 1774, in Cohoes, died in Mayfield, New York, January 23, 1853. He married Alida Fonda. Jacob W. (7), was born in Cohoes, September 7, 1795, died November 5, 1848; married Helena Wynkoop. Their son, William J., was the father of James Albert Lansing.

The ancestry of Mr. Lansing in the maternal American line antedates the paternal, and has a more stirring record, replete with patriotic deeds. Almira Smith (Cornwall) Lansing, wife of William J. Lansing, was descended from William Cornwall, a native of England, who emigrated from his native land in the early part of the seventeenth century. He and his wife, Joan, are on record as having joined the church at Roxbury, Massachusetts, in 1633. In May of the same year he was one of a band of seventy-seven soldiers, who, in revenge for constant depredations, attacked and nearly exterminated the tribe of Pequot Indians in their fort at Mystic, Connecticut. He was later, in 1654, 1664, and 1665, a representative to the colonial legislature of Connecticut from Middletown. His son John was a sergeant in the militia at Bunker Hill. Benjamin, son of John, was one of fourteen volunteers who enlisted from Middletown in the expedition against Canada in 1707. It is recorded that he left an estate valued at nine thousand pounds. His son Cornelius, born in 1722, was a lieutenant in the militia, served in the French and Indian War and participated in the siege of Quebec, under General Wolfe, in 1759. Ashbel, son of Cornelius, was born in Middletown in 1754. He was a private in the Revolution in 1775, fought in the battle of Bunker Hill, served with Benedict Arnold in the expedition against Montreal, and was captain in the War of 1812-1814, marching with his company from Middletown, Connecticut, to Sacketts Harbor, New York. His old powder horn is now in possession of Mr. Lansing. Ashbel, son of Captain Ashbel Cornwall, was born in Middletown, Connecticut, in 1784, died in 1868, and was the father of Almira Smith Cornwall, who became the wife of William J. Lansing and the mother of James Albert Lansing.

William J. Lansing, was born in Cohoes, New York, August 12, 1818, died in Champion, New York, January 29, 1864. He was a carriage maker by occupation, a man of sterling integrity. Throughout his entire life he was an exemplary adherent to the faith of his forefathers, and an attendant of their church, the Dutch Reformed. Early in life a supporter of the Whig party, his antipathy to human servitude made him an uncompromising Abolitionist. At the formation of the Republican party, he allied himself therewith, and cast his vote for John C. Fremont, its first presidential candidate, casting his last ballot for Abraham Lincoln. He married Almira Smith Cornwall, born in Broadalbin, New York.

James Albert Lansing, son of William J. and Almira Smith (Cornwall) Lansing, was born in Montague, Lewis county, New York, October 17, 1851. Until he was thirteen years of age he attended the public schools, and attracted by the school room, made excellent use of his opportunity for study. At that age he left home to support himself, a task to which he set himself



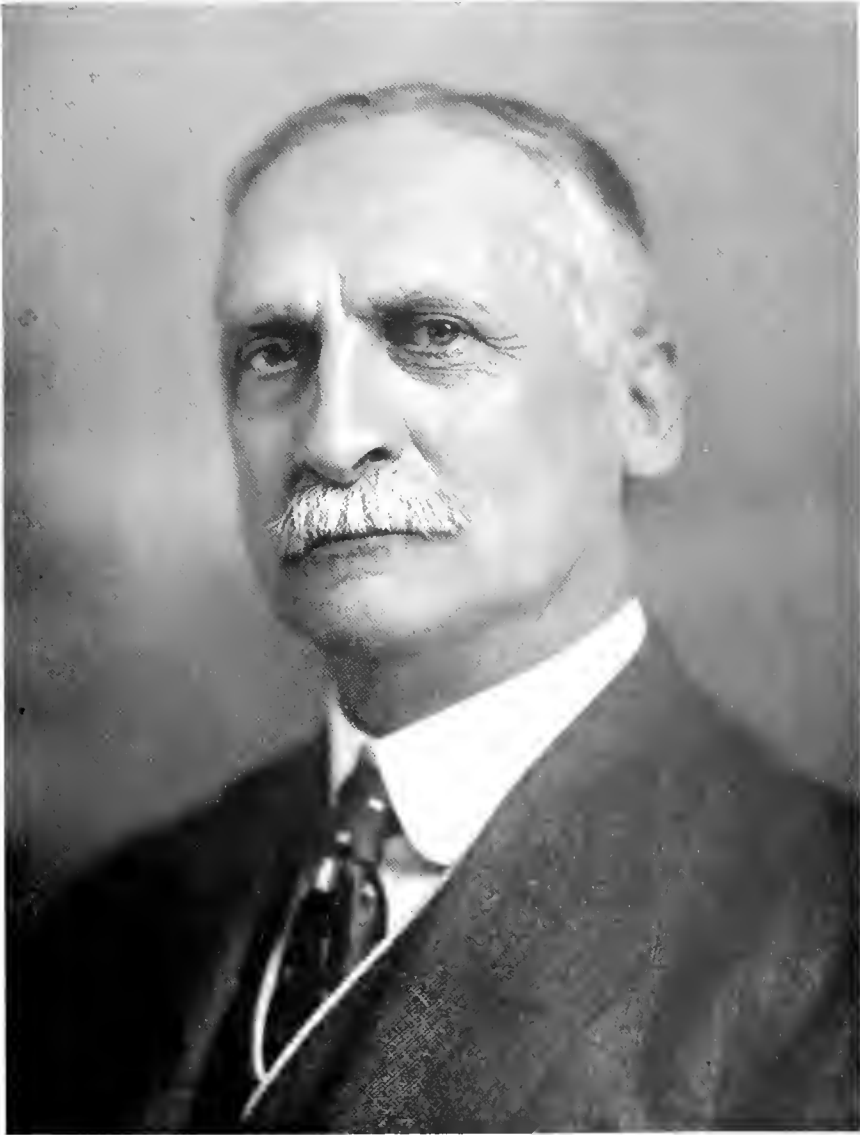

*J. A. Lansing*



with all of the energy and enthusiasm that has been so conspicuous in whatever he has attempted. For two years he did a man's work on a neighboring farm, attending school for about two months in the middle of the winter, when the weather was so inclement as to make outside labor impossible. He then apprenticed himself to a tinsmith, under whom he so thoroughly mastered his trade that, at the completion of his apprenticeship, his preceptor, then his employer, offered to admit him into equal partnership in the business. While grateful for the friendly interest shown and the generosity of the proposition, inasmuch as he was without funds, Mr. Lansing decided to enter the stove business as a traveling salesman. By this decision he entered into a line in which he has achieved fortune and distinction, and was diverted both from a tinsmith's life and that of a lawyer, the latter having always been his favorite profession and one for which he had done some private preparatory study.

Mr. Lansing's connection with Scranton and her interests began in February, 1882, when, in partnership with A. C. Fuller, he purchased a controlling interest in the Scranton Stove Works, an industry founded in 1866 by several of the citizens of Scranton who formed the circle of business men most prominent in the city's enterprises, Colonel J. A. Price, J. J. Albright, J. Curtis Platt, H. S. Pierce, J. A. Linn, and William Connell. After the death of Colonel Price, Mr. Lansing succeeded to the presidency of the company and has held that office to the present time. During his regime a new plant, with an output three times as large as the old foundry, has been built, and the location moved from West Lackawanna avenue to its present advantageous site. Additions have been made from time to time, until the Scranton Stove Works is the most extensive exclusively stove manufactory in the east and one of the largest in the world. The principal product is the celebrated Dockash brand of stoves and ranges, whose reputation is country wide, and which are shipped to nearly every foreign country.

Although a very busy man, Mr. Lansing contrives to give a great deal of his time to interests outside of his own, although the task of directing such a mammoth industry as his would more than occupy the time of an ordinary man. He was one of the original directors of the Scranton Bolt and Nut Company, and is now a director of the Scranton Knitting Mill and the Scranton Hardware Company. In the public service he has also measured up to the obligations of a citizen with the best good of his community at heart and has given liberally of his time and service to his city. For six years he was a member of the select council and was a member of the sinking fund commission for several years after Scranton received its rating as a city of the second class. The capacity in which he has been able to render the most important services to the city was as president of the board of trade, and as member of the manufacturer's committee of the same for the long period of eighteen years. He was ever one of the board's most progressive members, abounding in new ideas, and always led on to further endeavors by a view of a larger, richer, better Scranton, the equal of the inland manufacturing cities and a pride to the state. During his presidency of the board its powers were enlarged, its influence increased, and many new and now flourishing industries encouraged in making the city their home. Under Mr. Lansing's leadership the board of trade promulgated and brought to a successful consummation a work of nation-wide importance, influence, and benefit, for which he and his colleagues received warm and hearty commendations from all parts of the country; that is, Mr. Lansing originated, and the board hacked, a movement resulting in the passage by Congress of an act providing for the establishment of national banks of issue with a capital of \$25,000 in towns

of less than three thousand population. The passage of the bill of our great deliberative forum in the form in which it was presented by Mr. Lansing and in which it emanated from the board is an eloquent testimonial to the knowledge of financial conditions of its composer and testifies to the intelligent interest taken by him in affairs of national importance. Broadminded, he perceived the beneficial effects of this measure, which led to an appreciation of the methods of the national banking system, and its extension of the smaller towns in rural districts, a movement which eliminated many private banks, instituting in their stead a more stable and uniform chain of banks under government supervision.

The most recent recognition of Mr. Lansing's standing among those engaged in stove manufacturing came in the form of his unanimous election to the presidency of the National Association of Stove Manufacturers, assembled in their forty-second annual convention at New York. The association has within its membership nearly every prominent stove manufacturer in the United States, representing capital of \$75,000,000 and giving employment to 25,000 men. His election to the presidency of this association, organized for the common benefit of its members, is a marked tribute to the regard in which he is nationally held by his associates in business and testifies to his value in the councils of the organization.

Another proof of the amazing versatility of Mr. Lansing is the part he plays in the religious life of Scranton. He is an elder of the Presbyterian church and in the work of the Sabbath school has always assumed a heavy load of responsibility, serving in the capacity of superintendent. It is here that he has formed connections that will endear him to the hearts of Scranton's citizens long after he and his generation have gone to immortal rest. Gentle spirited and of a kindly nature, his warm, friendly and sympathetic manner has won him many firm and fast friends among the young people of his Sunday school, upon whom the lofty example of his blameless life will leave a lasting impression for good. To various benevolent and charitable institutions he gives cheerful and liberal support. In his private philanthropy he has been the agent by which many a man, disheartened and discouraged by the "slings and arrows of outrageous fortune," has been lifted from the depths of despondency and often much lower levels, and placed upon a plane leading upward to higher and better things. Reckless giving, so often adding to the degradation of the beneficiary, has had no part in his benevolences, all of the favors he bestows having the aim of giving the recipient faith in the powers he has lost. His political faith is Republican, and the principles of his party he forcefully advocates, holding a firm position on the questions of the day in regard to the protection of American industries and commerce. The business and social organizations of which Mr. Lansing is a member are the Manufacturers' Club, of Philadelphia; the Scranton and County Clubs, of Scranton; the New England Society, of Scranton; the Pennsylvania Society, Sons of the Revolution, of Philadelphia, and the Holland Society of New York.

He married, May 8, 1877, Mary Frances Waters, of Copenhagen, New York, daughter of Lyman Twining and Sarah Jane (Shepherd) Waters, both descendants of old New England families. They are the parents of one daughter, Ruth, born February 14, 1892.

Of Mr. Lansing's rise to his present important and prominent station, mention has been made, as also his devoted service to his church and in behalf of his city's welfare. The facts have been cited, and it is only left to point to the noble manner in which he has held true to the ideals of his family cherished through so many generations, and how, the present day representative of illustrious forbears, has proven the steel of his name and brought

wealth, position, honor, and reputation to lay at the feet of the shrine that begat him, the houses of Cornwall and Lansing.

---

### BENJAMIN E. WATSON

A resident of Scranton since boyhood, Benjamin E. Watson, after passing through various positions, is now the capable secretary and treasurer of the Scranton Stove Works, one of the important industrial enterprises of the city. He is a son of Charles and Jane (Baxter) Watson, who came to the United States on their wedding trip, and to Scranton in about the year 1857. Jane Baxter was a member of the Baxter family, famous in Glasgow as book publishers, her mother being buried in that city in the Baxter family burial plot.

Charles Watson was born in Ayr, Scotland, there grew to manhood, learned the carpenter's trade and immediately after his marriage came to the United States, settling in Scranton, Pennsylvania. For a time after his location here he followed his trade with the Dickson Manufacturing Company and in the car shops of the Delaware, Lackawanna & Western Railroad, after which he began business as a contractor and builder. In the latter capacity he contracted for and built the wooden portion of all the depots on the Delaware, Lackawanna & Western Railroad between Great Bend and Stroudsburg, also the old Delaware, Lackawanna & Western Station in Scranton. He was successful as a builder until the burning of his shop and ill health caused him to abandon the city and remove to Flemington, New Jersey. There he lived retired for a time, doing a little farming. Later in life he returned to Scranton where he died in 1893 within a few days of his sixtieth birthday. He was reared in the Presbyterian church but was affiliated with the Adams Avenue Methodist Episcopal Church, and in New Jersey was superintendent of the Sunday school. After his return to Scranton he became a member of the Second Presbyterian Church, of which he was an elder. He was a member of the Independent Order of Odd Fellows, and in all walks of life was an honorable, Christian gentleman. His wife, Jane (Baxter) Watson, died in 1903 aged seventy-eight years. Children: Charles J., John G., James B., George W., Benjamin E., of whom further; Robert M., deceased.

Benjamin E. Watson was born in Flemington, New Jersey, February 9, 1868. He was educated in the public schools there and in Scranton, finishing a high school course. He began business as clerk with the Green Ridge Coal Company, but shortly afterward entered the employ of the Scranton Stove Works as office assistant. In January, 1893, he was elected a director of the company, on January 11, 1896, was elected secretary, and on June 10, 1911, was chosen treasurer, which position he now holds. During these years he studied law under the direction of C. R. Bedford, of Scranton, and in September, 1900, was admitted to the Lackawanna county bar, but has not actively practiced his profession. He has given the office management of his company his undivided energy, and in that department ranks with the most capable of business men. He is a member of the First Presbyterian Church, is active in Sunday school work, serving as assistant superintendent. Mr. Watson married, April 21, 1897, Jessie S., daughter of A. H. Coursen, of an old Scranton family. Children: Benjamin E. and Catherine A. The family home is at No. 709 Madison avenue.

---

### HERSCHEL J. HALL

The Hall family of Rhode Island, a most ancient and honorable one, remained in New England several generations, Jonathan Hall, great-grandfather

of Herschel J. Hall, of Scranton, being the first of this branch to settle in Pennsylvania. He located at Abington, purchasing land from the government, and there spent his after life engaged in farming and lumbering, owning a saw mill, converting into lumber the trees cut from his own lands.

(II) Jabez G. Hall, son of Jonathan Hall, was born in Abington and there died in 1883 aged eighty-three years. He was a farmer, and for many years was collector of taxes for his township. He married Laura Callender, seven of their sons serving in the Union army during the war between the states.

(III) Byron G. Hall, son of Jabez G. Hall, was born in Abington in 1837, died June 6, 1912. He grew to manhood at the home farm, then for twenty-five years engaged in the butcher business, finally returned to his early occupation, farming, although he continued to conduct a small meat business. He served as Burgess for several years, a member of council and school director, serving faithfully in every position in which placed. He enlisted in the Union army with his six brothers, and was engaged in several skirmishes preceding the battle of Gettysburg. He and his family were all members of the Baptist church, he serving many years as trustee. He married Catherine Kirkman, daughter of John Kirkman, he born in Cornwall, England, his daughter in Yonkers, New York; children: Edward L., Thomas G., Robert B., Herschel J.

(IV) Herschel J. Hall, youngest son of Byron G. and Catherine (Kirkman) Hall, was born in Scott township, Lackawanna county, Pennsylvania, May 13, 1865. He attended the public schools of Abington, finishing his studies at a business college in Delaware, Ohio. He began business life in Dickson City, Pennsylvania, holding his first position under John Jermyn, continuing with him eighteen months, then for six months was in the employ of the Scranton Supply and Machinery Company and with Dale & Company about three months. At the expiration of the latter period he began his association with the Scranton Lace Curtain Company, acting first as bookkeeper. Two years later the company was reorganized under its present name and management, Mr. Hall being advanced to the post of secretary, and in 1913 was appointed to the additional responsibilities of assistant treasurer. He also holds these same positions in the Scranton Lace Company, a corporation formed to act as selling agents for the factory output of the Scranton Lace Curtain Company. He is also a director of the Byxbee Publishing Company, of Chicago. Mr. Hall possesses the essential qualities of the modern successful business man; has risen to his important position in the business through his own force of character and in winning his way has also won the respect and esteem of his associates. He is an active member of Abington Baptist Church and with his wife is useful in the Sunday school and missionary work of the church, he being one of the deacons and the efficient superintendent of the Sunday school. Mr. Hall married Rene Shedd, daughter of Walter Shedd, of Kankakee, Illinois.

---

#### BENJAMIN B. HICKS

On arriving from England at an early date the Hicks emigrant settled near Philadelphia, Pennsylvania, and later the family located in Columbia county, where the name is perpetuated in "Hicks Ferry" established in the year 1800 by Mahlon Hicks, grandfather of Benjamin B. Hicks, of Scranton, and yet in existence.

Mordecai Millard Hicks, son of Mahlon Hicks, was born at Willow Grove, Columbia county, Pennsylvania, died in 1904, aged seventy-two years. Though originally of a Quaker family, Mordecai Willard Hicks became a pillar of strength in the Methodist Episcopal Church at Willow Grove, serving as steward.

trustee and for many years as class leader, his wife also being an active church worker. He was a farmer all his active years, and an active member of the Patrons of Husbandry. He married Harriet M., daughter of William Stahl, of Briar Creek, Pennsylvania. Five of their seven children grew to man and womanhood: Minnie, married Benjamin F. Hicks; Alice, married S. W. Kelcher; Samuel H., Benjamin B.; Susan, married C. H. Kline, of Bloomsburg, Pennsylvania.

Benjamin B. Hicks, youngest living son of Mordecai Millard and Harriet M. (Stahl) Hicks, was born at Willow Grove, Columbia county, Pennsylvania, December 8, 1864. He grew to manhood at the home farm, and obtained a good education in the public schools of Willow Grove. He continued his father's assistant at the farm until 1884, then left home and spent the following summer at Light Street, Pennsylvania. The next year he entered the employ of the Delaware, Lackawanna & Western Railroad Company at Plymouth, Luzerne county, first as a helper in the freight house. In about a year he won promotion to the position of baggage master, later being appointed assistant ticket agent. In 1890 he came to Scranton as transcript clerk for the United States Express Company, later becoming cashier, a position he held three years. In 1893 he began his twenty years association with the Third National Bank of Scranton, beginning as clerk and bookkeeper. He won his way steadily upward until 1909, when he was elected cashier, which responsible position he now holds. In matters religious, he has not departed from the example and early teaching of his honored parents, but is a valued and useful member of the Elm Park Methodist Episcopal Church. Active in all departments of church work his especial interest has ever been in the Sunday school which he has served as assistant superintendent for twenty years. He is also a member of the official board, chief usher, collector of pew rents and always ready to lend a helping hand whenever needed. His wife is a co-worker in the church, active in missionary work, and in women's special departments. Mr. Hicks is a member of Peter Williamson Lodge, Free and Accepted Masons, and of the Order of Heptasophs. In political faith he has always been a Republican. A trusted bank official, an upright citizen, and a valued friend, Mr. Hicks has fairly earned the general esteem in which he is held.

Mr. Hicks married, September 9, 1891, Lydia M. Shaffer, daughter of Samuel U. Shaffer, of Plymouth, Pennsylvania. Children: Millard Utley and Harriet Elizabeth. The family home is at No. 220 Colfax avenue, Scranton.

---

#### RICHARD J. MATTHEWS

Of English birth and parentage, Mr. Matthews has been a resident of Pennsylvania since 1841, when as a child of three years he was brought by his parents to Honesdale. Since 1860 he has been engaged in business in Scranton, where the name is a household word, through the long and active business relations of Matthews Brothers and Matthews & Sons. For over a half a century Matthews Brothers have been wholesale and retail dealers in drugs, paints and oils, one of the original founders of the firm, Charles P. Matthews, later withdrawing and is now the head of the wholesale flour, feed and grain firm, C. P. Matthews & Sons. The present firm of Matthews Brothers, wholesale and retail dealers in drugs, paints and oils, is a corporation, Richard J. Matthews selling his interest to a nephew, Walter L. Matthews, treasurer of the present company; Charles W. Matthews being president; both are sons of the original partners, Charles P. and William Matthews.

which after fifty-six years from its founding passed out of existence as a partnership, beginning its corporate existence, February 19, 1913.

The memory of the oldest inhabitant hardly carries back to a period when one of the name of Matthews was not connected with the mercantile interests of Scranton, yet Richard J. Matthews, whose career follows, gives no unusual evidence of his years, seventy-five, or of his over half a century of active business life, so perfect in his health and so active his mind.

Robert Matthews and his wife, Ann (Henwood) Matthews, both of Cornwall, England, came to the United States about 1841 with sons, William, Charles P., Richard J., and daughter, Elizabeth. He did not come in pursuit of fortune, as he was an educated gentleman of means, but rather perhaps to give his sons the advantages a new country like this offers to young men. He located at Honesdale, Pennsylvania, where he purchased land, engaging in its management and operation by tenant farmers or hired labor.

Richard J. Matthews obtained a good education in public and private schools and remained at home in Honesdale until 1858, when he obtained a position in a bank in New York and spent about one year in that city. In 1860 he came to Scranton where for about a year he was clerk for his brother, Charles P. Matthews, who had a store where the Fuller Building now stands. In 1861 Richard J. Matthews purchased an established retail drug store in Providence, which he conducted for nine years. He then returned to Scranton, joining his brothers, William and Charles P., who were conducting a wholesale drug, paint and oil business under the firm name of Matthews Brothers, the original business having been established by Charles P. Matthews in 1857. About 1871 he retired from the firm, Richard J. and William continuing. William Matthews at this time was also manager of the People's Street Railway Company, consequently the burden of management of Matthews Brothers fell upon the younger brother, Richard J., who, however, was fully equal to the task. While in the early years the business was small, it constantly increased until a force of twenty-eight men is required in its operation. It is the oldest drug house in Northeastern Pennsylvania and has a well established trade in the Lackawanna and Wyoming Valleys. The present building at No. 320 Lackawanna avenue, was erected prior to 1870. Then until January 1, 1913, the firm consisted of Charles W., a son of William Matthews, and Richard J. Matthews, the only member of the original firm then connected with the business. While the principal burden of business was allowed to rest upon the shoulders of the younger man, the elder partner was actively "in the harness" and still has important official connection with other Scranton institutions. He is president of the Black Diamond Silk Company and director of the Title, Guarantee and Trust Company. He attends the First Presbyterian Church, and is a director of the Pennsylvania Oral School for Deaf Mutes, an institution in which he takes a great interest. In political preference he is a Republican.

Richard J. Matthews married, March 8, 1864, Imogene Leach, of Providence, Pennsylvania. Six children: Anna, married Joseph J. H. S. Lynch; Flora L.; Mary, married George P. Griffith Jr.; Alice, married W. H. Storrs, deceased; Helen; Burton.

---

#### RALPH A. AMERMAN

Amerman is a name well known in the legislative annals of Pennsylvania, and connected prominently with one of the most far-reaching beneficial acts ever passed in the state i. e.: The Free School Bill, of which Lemuel Amerman, father of Ralph A. Amerman, was the legislative father. Prior to his valuable







*Samuel Amerman*

public service, his father, Jesse C. Amerman, a dairy farmer near Danville, Pennsylvania, served several years in the Pennsylvania legislature, as a Democrat. Jesse C. Amerman was also a veteran of the Civil War, attaining the rank of sergeant-major.

Lemuel Amerman was a graduate of Mansfield State Normal School, and of Bucknell College, and prior to his legal study was a teacher in the former institution. He read law with James A. Gordon, of Philadelphia, and after his admission to the bar located in Scranton, where he was active and prominent in law, politics and business. He was prominent in the development of water privileges of his section, holding directorship in the Spring Brook, Mansfield, Minooka and Rendaham water companies. He was a Democrat in politics, and for several years clerk of the Pennsylvania house of representatives. He was later elected a member of the house from Scranton, and among the important bills he fathered and championed was the act providing for free public instruction. He also served a term in Congress. His public career was long and honorable, and the results of his wisdom and public spirit will continue until "time shall be no more." He was also prominent in the legal profession, and served several years as city solicitor of Scranton. He was an active member of the congregation of Emmanuel Baptist Church, and also interested in Sunday school work, serving as superintendent. He married Mary Van Nort, of Scranton, who bore him a son, Ralph A., and a daughter, Mary, now the wife of Frederick Lewis, of Norfolk, Virginia.

Ralph A. Amerman, only son of Lemuel and Mary (Van Nort) Amerman, was born in Scranton, Pennsylvania, May 19, 1884. He attended the public schools of Scranton and Worcester Academy (Massachusetts), then entered Cornell University, taking at the latter institution the civil engineering course. After finishing his college course and arriving at legal age, he assisted in the organization of the Scranton Real Estate Company, and from 1905 until 1908 was engaged in the service of that company. In 1908 he organized the Scranton Automobile Company for the promotion and sale of the Buick car. He is the general agent for the Buick car in Northeastern Pennsylvania, having sub-agents thoroughly covering the territory. The company also was engaged in the sale of auto accessories and maintained an extensive repair department. He also has other extensive business affairs, including the Scranton Taxicab Company, of which he is president. His college fraternity is Kappa Sigma (Cornell); his secret fraternities: Lodge, Chapter, Commandery, Shrine and Consistory of the Masonic Order; clubs, the Scranton, Country, Press, Bicycle, Temple. A true son of his honored father, he is interested in both church and education, serving as trustee of Emmanuel Baptist Church; president of the board of trustee of Keystone Academy and trustee of Bucknell University. Mr. Amerman married Ada, daughter of Rev. John S. Wrightnour, pastor of the First Baptist Church of Scranton. The family home is at No. 537 Monroe avenue.

---

#### JOSEPH F. KELLER

Descendant of a sturdy German emigrant, who settled prior to the Revolution in Northampton county, Pennsylvania, Joseph F. Keller, of Scranton, inherits a legacy of patriotism, devotion to duty and manly character. These traits have been strongly manifested in preceding generations and have not been lost in the transmission to the present representative of the family.

The emigrant Keller fought in the Revolution, for the cause of liberty, was captured by the British at Marcus Hook and in his suffering kindled in the blood a spirit that blazed forth in his grandson, Theodore Keller, a soldier

of the Civil War, captured at Gettysburg and confined at the Confederate prison at Belle Isle. But the martial spirit thus transmitted has been tempered by a generation of peaceful pursuits, the second generation having been farmers.

The grandfather of Joseph F. Keller, born in Cherry Valley, Monroe county, Pennsylvania, on the paternal farm, there lived, died and was buried, an old man of eighty-five years. He was a prominent man in his locality, a pillar and liberal supporter of the German Reformed Church, commissioner of roads and school director. His wife, Elizabeth (Heller) Keller, was also a native of Cherry Valley.

Theodore Keller, of the third generation in Pennsylvania, was born in Cherry Valley, Monroe county, April 26, 1842. He learned the trade of wheelwright and for many years followed that and house carpentry. In 1883 he settled in Dunmore, and shortly afterward entered the employ of the Dixon Manufacturing Company, with whom he remained seventeen years, then returned to his trade. He and his family worship in the Methodist Episcopal Church. During the war between the states he enlisted in Company C, One Hundred and Fifty-third Regiment Pennsylvania Volunteer Infantry, and fought in all the battles in which his regiment was engaged until Gettysburg, where he was captured, taken South and held a prisoner at Belle Isle. He is a member of Griffin Post, No. 139, G. A. R. Theodore Keller married Martha, daughter of Abel Staples, of Beaver Valley, Pennsylvania, of a family that also traces in Pennsylvania to the days of the Revolution. Children (now living): Lily; Harriet, married Arthur Spencer, of Dunmore; Joseph F.; May, wife of Richard Angwin, of Dunmore.

Joseph F. Keller, son of Theodore and Martha (Staples) Keller, was born at Stroudsburg, Pennsylvania, November 12, 1873. Until fifteen years of age he attended public school, then spent three years on the Wagner cattle ranch in Texas. He then came to Scranton, and began learning the carpenter's trade, continuing as a journeyman four years after finishing his apprenticeship. He was ambitious and was determined to obtain more than a knowledge of the correct use of tools. He studied the principles of building construction and read such books as treated on the strength of timber and builder's materials until he was capable of superintending the erection of important buildings, as well as becoming expert in the use of tools. In the pursuit of his calling, he traveled all over the United States, and was superintendent in charge of some important buildings, including some for the government in Washington. He worked from ocean to ocean in the large cities and gained a vast fund of valuable experience on the different styles and quality of the buildings he superintended. In 1897 he located permanently in Scranton as a building contractor. In 1911 he formed a partnership with Russel H. Dean and as Keller & Dean has conducted a most successful business, making a specialty of fine residential and factory construction. The firm holds an enviable position as competent, reliable builders, and have executed many important contracts. In his relations with his employees, Mr. Keller is just to a point of generosity, straining every point possible in their favor. He possesses the perfect confidence of his men, who know their interests are carefully considered. As a result he has a loyal corps of good workmen always at his command and is able to better estimate on the time clause of many of his contracts, a most important item on which important contracts are often awarded. Still a young man, Mr. Keller deserves the highest encomiums for the position he has attained as a contractor and builder. He has displayed an energy and ambition to rise that has not brought him influential friends, but has made his further rise in the building world certain. He is a Republican in politics,

and an attendant of the Methodist Episcopal Church. He is a member of the Independent Order of Heptasophs. Mr. Keller married, January 12, 1903, Myrtle Irene, daughter of Byron Davis, of Dunmore, and has a daughter, Elizabeth Virginia.

---

#### FRANCIS O. MEGARGEE

To the Megargee family, of Scranton, there is accorded the double honor of being descended from an ancestor whose voyage to America was made with the leader of the Society of Friends in America, William Penn, and of having continued in the family for a century and a half the art of paper making. The first, an accident of birth and residence, is nevertheless a satisfaction to those caring for the prestige attached to antiquity of family, while the second reflects credit upon those of the name who perpetuated the trade instituted as a family occupation so many years ago. The original home of the Megargees was in the south of Ireland where the terminal letter was "l", instead of "e". With a strength of conscience and a simplicity of character that has characterized the family through the entire descent, the American father of this branch of the Megargees cast his lot with Penn's band of Quakers and resolutely set his face toward the West, expecting to find there, in the wilderness beyond the sea, not only a richer home, but a new land and free, where each man might live out his own salvation, unbound by the beliefs or actions of his neighbors.

Jacob Megargee, grandfather of Francis O. Megargee, was a native paper manufacturer and inn keeper of Rising Sun, Philadelphia. His son, Sylvester Jacob Megargee, was born in Philadelphia in 1817. He engaged all his life in the business instituted by his father, the paper manufacturing, in which he was very successful. Book paper was the line in which he specialized. In 1876 he retired from active participation in any enterprise and lived a quiet and peaceful life until his death in 1880, aged sixty-three years. He married Ann V. Gaffney, born in Baltimore, Maryland. Of their eight children, four are living, two in Scranton. Children: Sylvester Edwin, of Philadelphia; Charles G., of Florida; Bernard B.; Francis Octavius.

Francis Octavius Megargee, son of Sylvester Jacob and Ann V. (Gaffney) Megargee, was born in Philadelphia, Pennsylvania, August 10, 1862, died September 3, 1914, at his home in Dunmore. He obtained his education in a private school in Philadelphia, in La Salle College, from which he graduated and in the Ross Military Academy, and soon after the completion of his studies entered the employ of the Megargee Brothers, the leading paper manufacturing house in Philadelphia, as commercial traveler. He had been with this firm for about six years, when they discontinued business, Mr. Megargee accepting a position with I. M. Megargee & Company. The business of this firm was the same as that of the one by which he had been previously employed, and after four and a half years service, Mr. Megargee came to Scranton, November 1, 1890, where he was a member of the firm of Megargee Brothers in the general paper business. He and his brother, Bernard B., who comprised the firm, opened headquarters in the Burr building, and the business greatly expanded, becoming the leader in that line not only in Scranton but all through Northeastern Pennsylvania and parts of New York state. His business interests were as vice-president of the International Poultry Supply Company of Brown's Mills, New Jersey, and director of the First National Bank of Dunmore, of which he was an organizer. He was mainly responsible for the organization of the Scranton Poultry Association, and the popularizing of poultry raising. In that field he was an expert. His social

connections were with the Scranton Club, the Green Ridge Club, the Press Club, and the Canoe Club. He was a member of St. Paul's Roman Catholic Church, of which his wife is also a member.

Mr. Megargee married, June 29, 1899, Katherine, daughter of William W. Haggerty, of Philadelphia. She was the principal of the commercial department of the Central High School, of Scranton. Children: Francis S., Katherine B., Robert W., Ann E., Marjorie F., Edwin Irvin. Mr. Megargee was a popular figure in Scranton society, a progressive, public spirited, unselfish citizen.

---

#### EDWARD EISELE

Edward Eisele, city controller of Scranton, is a descendant of an old German family, whose presence in the United States dates back but one generation. His father, John F. Eisele, was born in Selinger, Wurtemberg, Germany, in 1830. He there attended the elementary schools and the gymnasium, learning the tailor's trade. When a young man he came to New York and there following his trade, of which he was a skilled master, until 1855. He then came to Scranton, continuing in the pursuit of his occupation until his retirement, and still making that place his residence (although he did not follow his calling for many years), until his death September 26, 1913, aged eighty-three years. With his wife he was a member of the German Lutheran church, at whose services both were regular attendants. He belonged to Alliance Lodge No. 540, I. O. O. F., in which he was past grand, and for twenty-five years was treasurer of that organization.

He married Katherine Durner, and of this union twelve children were born, of whom five are living: J. George, general salesagent of the Delaware and Hudson Coal Company, resides in Scranton; Louisa M., married Emanuel Fitzelman, deceased, of Scranton; John F., Jr.; Charles W., of Flint, Michigan; Edward, of further mention.

Edward Eisele, son of John F. and Katherine (Durner) Eisele, was born in Scranton, Pennsylvania, July 11, 1875. He attended the public schools in his youth and after discontinuing his studies worked at various industries at one time being employed in a boiler shop. He then engaged in office work, and was in the office of City Treasurer Robinson from 1899 to 1902, and later in the office of the city controller. He there gained the experience that has been so valuable to him in discharging the duties of the office of city controller, which he has held since April, 1905. His rise to that position has been the result of his constant application to the acquiring of a perfect knowledge of the duty at hand. While acting in the capacity of clerk in the office of which he is now the head, there was no detail of the routine that escaped his vigilant notice, and when the office of city controller was left vacant, he was the logical choice. He performs his public duties thoroughly and conscientiously, an upright and incorruptible official. In the full vigor of youth, his opportunity for still further exploration and conquest in political circles is great, and it is not likely that he will disregard it. Mr. Eisele is a member of Schiller Lodge, No. 345, F. and A. M.; of Alliance Lodge, No. 540, I. O. O. F., of which he is past grand; and the Liederkranz, in which he held the office of financial secretary for seven years. With his wife, he is a communicant of the German Lutheran church.

He married Rose, daughter of Herman Hagen, of Scranton. Children: Ruth and Edward, Jr.





*Hugh A. Dawson*



## HUGH A. DAWSON

The aphorism to the effect that "the earth is our mother" is familiar to all, and reasoning to fundamentals it is an indisputable fact that all of our necessities, comforts and luxuries come to us from this source. There are no more striking examples of maternal prodigality in the bestowing of gracious favors than in the cases of those to whom Mother Earth has opened the treasure stores of her bosom and given entrance to inestimable riches. Hugh A. Dawson, of this chronicle, is one who has been a beneficiary of her lavish generosity, his prosperity and success having come through the seizure of opportunity thus freely offered.

This branch of the Dawson family of which he is a member is of Irish ancestry, the home of all of the name having been county Kilkenny, Ireland, whence came William Dawson at the age of eighteen years. He first located at Paterson, New Jersey, and there followed the trade of an iron moulder until 1884, moving in that year to Scranton, Pennsylvania, entering the employ of the Dickson Manufacturing Company. He had ever been a strong supporter of the Republican party, and in 1896, when he was elected city assessor for a term of three years, he resigned his position with the Dickson Company to fulfill the duties of the office. At the expiration of his term he accepted a clerkship in the state banking department at Harrisburg and after five years of service was promoted to chief clerk, remaining in that position eight years. In 1912 he returned to Scranton, and is now clerk in charge of the state tax in the office of the county commissioners. He married Anna L., daughter of Hugh Kennedy, of Scranton. Of their nine children, six reached maturity: John J., Hugh A., of further mention, William M., James J., Alice M., Anna M.

Hugh A. Dawson, third son and child of William and Anna L. (Kennedy) Dawson, was born in Scranton, Lackawanna county, Pennsylvania, July 24, 1884. He attended the public schools of Scranton, including the high school, and for one year engaged in study at the Young Men's Christian Association night school, later taking a one year course in the civil engineering department of the University of Pennsylvania. He then accepted a position with the Delaware and Hudson Company in the mining engineering department, his term of service covering a period of five years, from 1903 to 1908, in which time he was advanced from the position of chairman to that of division draughtsman. In the latter year he resigned to attend to the details of the incorporation of the Clearview Coal Company, of which, in partnership with L. B. Landau, he was a promoter. The company was organized in 1908 with L. B. Landau, president and general manager, and Hugh A. Dawson, treasurer and superintendent. The field of operation of the company is a lease held from the heirs of Giles Robinson, probably the last of the coal fields in that locality to come under lease. The concern employs on an average 200 hands, and has an output of 100,000 tons of coal annually. The sale of the product is largely local, although part of the output is shipped to New York and New England. The officers of the company were F. M. Van Horn, of New York, president, F. P. Christian, treasurer and general manager, and Hugh A. Dawson, superintendent. In 1913 he negotiated the sale of the company to a syndicate headed by F. P. Christian and was retained by them as general superintendent. Mr. Dawson fills his position as active director of the business with a great deal of ability, making himself personally acquainted with all the operations, from the digging of the ore to the shipping to the consumer. In this manner he is able to adjust all difficulties that may arise quickly and satisfactorily, where as an employer whose knowledge was limited to the number of men engaged

and their wages would be compelled to depend upon a subordinate of doubtful reliability. His popularity with those engaged in his line of activity is shown by his election as secretary of the United Mine Workers in 1903. In political belief he is a Republican, holding the office of judge of electors in his district for several years. In May, 1913, he was nominated for representative to the state legislature on the Republican ticket by the largest majority ever given a candidate in this district. As the district is normally Republican by 1,000 majority his election in November is a foregone conclusion.

Mr. Dawson is a member of the Greek letter fraternity, Alpha Tau Omega, Pennsylvania, Tau Chapter; the Railroad Young Men's Christian Association, the Engineers' Club of Northeastern Pennsylvania, the Scranton Club, the Scranton Press Club, the Scranton Bicycle Club, of which he is a director, the Knights of Columbus, the Benevolent and Protective Order of Elks, and Lackawanna Institute of History and Science. Mr. Dawson married Margaret, daughter of P. F. Weir, of Scranton, a teacher in the graded schools.

Judging entirely from his successful career in the coal business, a highly useful and prosperous career may be predicted for Mr. Dawson in the wider fields of endeavor to which he will be called. Not yet thirty years of age, he holds a position of responsibility that would justify the efforts of a much older and more experienced man.

---

#### ELLSWORTH KELLY

In common with many other Scranton families founded there at the opening of the vast and valuable coal fields in the contiguous region, the Kellys are of Welsh descent. James Kelly, grandfather of Ellsworth Kelly, came to the United States from Mountain Ash, Wales, in about 1865, bringing with him his wife and his son, John H., and locating at Scranton. Here James Kelly obtained employment in the mines of the neighborhood and spent his entire life.

(II) John H. Kelly, son of James Kelly, was born in Mountain Ash, Wales, November 27, 1855. He was but a lad when his parents brought him to this country and he was immediately placed in the public schools. In early young manhood he learned the stone moulder's trade, following that occupation for many years. On June 1, 1889, when David M. Jones was postmaster of Scranton, he received an appointment as mail carrier in the Scranton office. After twenty-five years of active service, during which time regularly and promptness have characterized the performance of his every official duty, he is still in the government employ, a remarkable record of fidelity. Mr. Kelly's religious convictions are Baptist, and he is a deacon and trustee of the First Welsh Baptist Church. He is an honored member of the Independent Order of Odd Fellows, and is past grand of Silurian Lodge. For over twenty years he has handled the finances of the lodge as treasurer and is now past district deputy grand master. He is also a member of the memorial committee of the Grand Lodge, and at the expiration of his third decade of service in the lodge, his home organization presented him with a medal in commendation of his long and useful career in the fraternity. He married Jane Evans, daughter of John W. Evans. Of their six children the following four attained maturity: Bertha, a school teacher in Scranton; Norma; Ellsworth, of further mention; Ruth.

(III) Ellsworth Kelly, son of John H. and Jane (Evans) Kelly, was born in Scranton, Pennsylvania, October 27, 1884. He acquired his education in the public schools of the city, and until he attained his majority was employed in various capacities on the staff of *The Republican*. His political career began May 28, 1905, when he was appointed clerk in the department of public



*Essewath Kelly.*



works. So efficient was he in the discharge of his duty and so rapidly did he familiarize himself with the method and system of the office that on December 1, 1906, about a year and a half after his entrance into the public works department, he was appointed chief clerk. It was while serving the city in this capacity that he became a candidate for the city clerkship and, victorious in the election, he entered upon the duties of his new office, January 2, 1912. He was re-elected city clerk at the reorganization of council held January 5, 1914. Although only having held the position for a short time, he has proven an able clerk, thoroughness and system predominating in all departments of his work. Mr. Kelly is prominent fraternally. He is a member of the Masonic Order, holding the thirty-second degree, belonging to the Keystone Consistory, Sovereign Princes of the Royal Secret. He is also a Noble of Irem Temple, Nobles of the Mystic Shrine. His other relations are with Lodge No. 123, B. P. O. E.; Hyde Park Lodge, Knights of Pythias; Green Ridge Camp, Modern Woodmen of America; Washington Camp, No. 178, P. O. S. A. The Scranton Athletic Club and Columbia Hose and Chemical Company, No. 5, of which he is president, number him among their members. In religious belief he is claimed by the faith of his father, and is a communicant of the First Welsh Baptist Church.

---

#### THOMAS MOORE

Thomas Moore is of the second generation of the name attaining prominence in the financial and mercantile departments of Scranton's industrial activity. Thomas Moore, the elder, came of a family who had been school masters for generations. Because of his father's profession, Thomas Moore, the elder, was granted an exceedingly thorough and remarkably wide education, without doubt the best that could be obtained outside of the walls of a university. Early in life he entered the employ of a firm engaging in the dry goods business, and when he had about attained his majority he came to New York City, there establishing in the dry goods business, and remaining until 1866. In that year he came to Scranton, and after a short period of independent dealing in his business, formed a partnership under the firm name of Moore & Finley, an association that continued many years. For years the name was synonymous with excellence and reliability to the shoppers of Scranton, and to many of the leading merchants of the city in the present day the establishment was a training school for their later careers, the fundamentals of every lesson learned being fair dealing and courtesy in all transactions. He served the Merchants and Mechanics Bank as vice-president for several years, his name lending strength to the institution and confidence to its depositors. Thomas Moore was a strong supporter of any movement tending to the educational uplift of the community in which he lived and was especially active in the management of the Keystone Academy at Factoryville, of which he was president of the board of trustees. He was the donor of the dormitory, occupied by the girls of the institution, known as Moore Memorial Hall. In the various organizations of the Penn Avenue Baptist Church, to which both he and his wife belonged, he was an earnest and useful worker.

Mr. Moore was a generous, open-hearted Christian gentleman, returning to the city much of his worldly goods derived therefrom, and held in universal respect for the enviable record he had made in the mercantile world by his unswervingly upright dealings. He married Mary Rodgers, of New York City, and of their eight children two grew to maturity: Mary, married William M. Marple, of Scranton; and Thomas, of further mention.

Thomas (2) Moore, son of Thomas (1) and Mary (Rodgers) Moore, was

born in New York City, and when a youth came with his parents to Scranton. His education, preparing him for college, was obtained in this city, but ill health prevented the further continuance of his studies and necessitated less confinement than would have been possible had he pursued his original intentions. He became interested in the Scranton Woodworking Company, manufacturers of cabinet work and interior finishings, remaining identified with this firm until 1888, when the partnership of Norrman & Moore was formed, general fire insurance being the field of operation selected by the partners as the least crowded and most lucrative then offering. Hardly had the new firm gotten well underway when Mr. Norrman's death left Mr. Moore alone in the business. In 1898 the pressure of work and the ever increasing needs of the business for more close personal supervision caused Mr. Moore to form the present firm of Moore & Foster. The new association was remarkably congenial and the success of their later enterprises is an encouraging courier of greater future prosperity.

Mr. Moore is a thirty-second degree Mason, Ancient and Accepted Scottish Rite, belonging to Keystone Consistory, Sovereign Princes of the Royal Secret, and is a Noble of Lu Lu Temple, Nobles of the Mystic Shrine, of Philadelphia, also a Knight Templar, of Melita Commandery. His other fraternal affiliation is with the Benevolent and Protective Order of Elks, and his social relations with the Scranton Club, the Country Club and the Green Ridge Club.

In his chosen line of endeavor Mr. Moore has acquired a reputation for his stability and reliability in business dealings, the result of the care he has exercised in associating himself only with propositions conducted upon a strictly business basis. Moore & Foster, in insurance circles, are equalling the name established a generation before by Moore & Finley, in mercantile circles; a notable achievement, indeed.

---

#### HENRY J. GUNSTER

The record of the Gunster family in Scranton is one of successful effort in whatever undertaken. The founder of the family in Pennsylvania was Joseph H. Gunster, born in Lockweiler, Germany, where he resided until the age of twenty years, then came to the United States settling in Providence, Pennsylvania, now a part of the city of Scranton. He learned the cabinet makers' trade in his native land and after coming to Providence, worked with David Harrington as journeyman for two years. He then established in business for himself, having a shop on Penn avenue, where for about twelve years he made fine furniture, becoming the leading furniture maker and dealer of the town. He prospered and when the Merchants and Mechanics Bank was organized, he became its first secretary. He continued with this institution until the organization of the City Bank, in which he assisted. He later became cashier of the City Bank, continuing some years, then sold his interest to Dr. Throop and resigned. He then served one term as deputy treasurer of Lackawanna county, and when the Scranton City Bank became involved he was appointed assignee. After winding up the affairs of that bank and receiving his discharge from the court, Mr. Gunster retired from active life. He was an able business man and a citizen above reproach. He stood high in Masonic circles, was past master of Shiller Lodge, Free and Accepted Masons; past high priest of Lackawanna Chapter, Royal Arch Masons and a sir knight of Coeur de Lion Commandery, Knights Templar.

He married Lucina, daughter of Michael Lutts of Greenridge, Pennsylvania. Children: Henry J., of whom further; Charles W., see sketch; George N., of the firm of Gunster Brothers; Lieutenant Walter E., of the

United States army; Arthur, member of the firm of Gunster Brothers. The latter firm was established in 1888 as Gunster & Forsythe, operating a small hardware and plumbing business. About 1902 Mr. Forsythe withdrew his interest, it being purchased by George N. and Arthur Gunster and the name changed to Gunster Brothers. At that time the firm employed three journeymen, now thirty-five men are necessary to promptly fill their many contracts in the installation of heating plants and the erection of heavy cornices and skylights, both in Scranton and outside points.

Henry J. Gunster, eldest son of Joseph H. and Lucina (Lutts) Gunster, was born in Scranton, January 11, 1858. He was educated in the public schools of the city, "Daddy Merrill's" private school and Newton Collegiate Institute, Newton, New Jersey. After completing his years of school life, he entered the employ of the Scranton City Bank, continuing about three years, then locating in Larimer City, Colorado, where for two years he was engaged as a retail grocer. He then moved to Denver, Colorado, where he entered the employ of Sprague Warner & Company, wholesale grocers of Chicago. In 1884 he returned to Scranton, where for a time he was with Forrest Brothers, later with Connell & Son, plumbers and hardware merchants. Shortly afterward he became a member of Gunster & Forsythe, a small plumbing and hardware firm. On the retirement of Mr. Forsythe, his interest was taken by George N. and Arthur Gunster, and the firm continued as Gunster Brothers, contracting engineers of steam and water heating apparatus and power plants for manufacturers. They also deal in hardware, glass, paints and oils, and are contractors of all kinds of plumbing, timing, cornice and skylight work of metal of every kind. The firm's warerooms and offices are at No. 325-327 Penn avenue, their sheet metal works at Nos. 324, 326 and 328 Raymond Court, their pipe shop at No. 320 and 322 Raymond Court. The firm is a prosperous one and ranks high among the enterprising, modern institutions of Scranton. Henry J. Gunster, the head of Gunster Brothers, was for six years a member of Company C, of the old City Guards; and is a member of the Board of Trade, and the Benevolent and Protective Order of Elks. In politics he is a Democrat, but has never sought or accepted office. He married Margaret Cannon, of Scranton, and resides at No. 705 Jefferson avenue.

---

#### CHARLES W. GUNSTER

Charles W. Gunster, second son of Joseph H. and Lucina (Lutts) Gunster, was born in Scranton, October 11, 1859, and obtained his primary and preparatory education in the public schools, and "Daddy Merrill's" private school. He passed the examinations for admission to Yale University, but did not matriculate, deciding instead to enter business life. He entered the employ of the Merchants and Mechanics Bank of Scranton as messenger boy and has steadily risen through all intervening grades to his present responsible position of cashier, his term of service with this institution serving a period of thirty-two years. He is a thorough financier, and well informed in the laws governing banking transactions, a close student of finance, a wise and careful banker and a safe adviser.

He is a member of Peter Williamson Lodge, Free and Accepted Masons, past high priest of Lackawanna Chapter, Royal Arch Masons; past eminent commander of Coeur de Lion Commandery, and a life member of Irem Temple, Ancient Arabic Order Nobles of the Mystic Shrine. He is also prominent in club life, belonging to the Scranton and Country clubs, and to the Scranton Liederkrantz. For sixteen years he was a member of Company C, Thirteenth Regiment Pennsylvania National Guard, enlisting as a private and

attaining the rank of lieutenant. He qualified as a sharp-shooter and shot on many of the winning teams at military tournaments. His standing among the bankers is shown in his selection as secretary of the Scranton Clearing House Association, and as secretary and chairman of a group of banks comprising the Pennsylvania Bankers Association. Mr. Gunster, like his father, is a supporter of the Second Presbyterian Church, of Scranton, and interested in other good works.

---

#### C. AUGUSTUS BATTENBERG

Descending from pure German ancestry, Mr. Battenberg, of the first American born generation, has made for himself an honored name in the state in which his father settled on leaving the Fatherland. The family record in the United States is one most creditable and includes service in the Union army by the then young German emigrant, Charles C., father of C. Augustus Battenberg. The United States cannot forget, nor too strongly praise, the military service rendered by our foreign born sons in every war we have ever waged, nor can too strong a wish be expressed that never in the future may they have to choose between loyalty to their native or to their adopted land. Add to their military service, their wonderful achievements in the arts of peace and to this the example of thrift, energy, and perseverance, and the debt becomes one that can never be paid save by the untrammelled opportunities our land has afforded them to exercise the traits mentioned to their everlasting advantage.

Charles C. Battenberg was born in Hofgeismar, near Cassel, Germany, in 1841, died in Archbald, Pennsylvania, in 1904. He was educated in the excellent school of his native province and when young came to Pennsylvania, locating at Archbald, where he became a stationary engineer. When the war between the states broke out he enlisted in Company H, 52nd Regiment, Pennsylvania Volunteer Infantry; re-enlisted, serving with ardor and bravery four years and receiving an honorable discharge, as captain of his company, from his grateful adopted country. After the war he located in Scranton; later he moved to Archbald entering the employ of the Delaware and Hudson Company, rising to the position of outside superintendent of their colliery at that place. At the time of his death he was postmaster of Archbald. He was a Republican in politics, a member of the Free and Accepted Masons, and of the Independent Order of Odd Fellows. He married Amelia Miller, born in Archbald, daughter of August C. Miller, a pioneer settler of that town, coming from Leipsig, Germany. He was a pianomaker in Germany, but in Archbald, followed cabinetmaking and carpentering, erecting many of the older buildings there.

C. Augustus Battenberg, son of Charles C. and Amelia C. (Miller) Battenberg, was born in Scranton, on Penn avenue, where the Eagle Hotel now stands, May 20, 1868. After graduating from the School of the Lackawanna of Scranton, he began the study of law under the preceptorship of James H. Torrey, and after thorough preparation was admitted to the Lackawanna county bar in 1894. He at once began the practice of his profession; was assistant city solicitor under Mr. Torrey and has attained a firm honorable position at the bar of his native county. He has been admitted to the various State and Federal Courts of the district, having a good practice in them all. In fraternal and church affairs he has ever been active, useful and prominent. He is a member of Green Ridge Presbyterian Church, of which he is an elder, and at the present time is superintendent of the Sunday school; past master of Aurora Lodge, Free and Accepted Masons of Jermyn, and past grand of Archbald Lodge, Independent Order of Odd Fellows.



## ANDREW B. WARMAN

Andrew B. Warman was born near Stewartville, New Jersey, May 12, 1863. His early boyhood was spent on the farm. Mr. Warman's father, Theodore P. Warman, having sold his farming interests, moved to Easton where he resided for about two years; later he came to Scranton. Here he and his brother established a wholesale produce and commission business under the name of E. G. Warman & Brother, located at No. 26 Lackawanna avenue. The company continued a successful business until the panic of 1873.

Andrew B. Warman attended West Ward Academy in Easton, and the public schools of Scranton until he was fourteen years old. He was first employed by Frank L. Crane, wholesale and retail hatter and furrier on Lackawanna avenue, remaining eight years with Mr. Crane, until the time he founded the business in which he is at present engaged. In 1885 the laundry business was in its infancy and Mr. Warman was one of the first pioneers, for he saw a prosperous future for this new industry, so the Lackawanna Laundry employing seven operators, was started at 231 Wyoming avenue. This site being unfavorably adapted to the business, the plant was moved to what is now the Grand Army of the Republic Building where it remained for six years. The laundry business was an established fact, and a new building especially adapted to the needs of the business was erected at 308 Penn avenue. In a few years Nos. 310 and 312 were added and new buildings erected. Continual changes have taken place and improvements been made. Seven years ago the plant was incorporated as the A. B. Warman Lackawanna Laundry Co., A. B. Warman, president; F. J. Donnelly, vice-president; C. W. Bertine, secretary. At present this plant is the finest equipped in the state. It covers 33,000 square feet of ground, is equipped with the most modern machinery, run entirely by electricity, each machine having an individual motor. The company generates its own electricity for power and light. There are on an average of 225 persons employed summer and winter, of whom fifty are men. This laundry is credited with many innovations, such as the Sturdevant System of Ventilation; a circulation of filtered fresh air is taken from the roof cooled and forced in the several departments. Here for the first time in the United States compressed air was applied to operating machines, thereby relieving the women operators from much labor. The founder by unceasing labors, not only in his own plant, but also in the National and State Laundry Association, serving in the latter for sometime as president, has helped to raise the laundry industry to its present state of recognition.

Nor is his private undertaking the only activity in which he is interested. Mr. Warman has served for years as director of the Peoples National Bank, director of the Board of Trade, director of the Maccar Company and trustee of the Emanuel Baptist Church. For ten years he served as director of the Y. M. C. A., the last two also in the capacity of president; he was also vice-president of Keystone Academy. Mr. Warman married Mary L., daughter of S. B. Stillwell of Scranton. Children: Saron B., Katherine S. and Donald S.

## BERNARD P. CONNOLLY

When, in 1892, Bernard P. Connolly and H. Clifford Wallace, trading as Connolly & Wallace, opened their dry goods store at No. 207 North Washington avenue, Scranton, Pennsylvania, they established the first of the many precedents by which the shoppers and clerks of Scranton have been benefited. It was then considered business suicide to attempt to draw trade to that avenue, Connolly & Wallace being the first merchants to attempt it. They began in a

small way with few employes, themselves acting as clerks. They prospered, however, and for five years did a thriving business in their original location. Their rapid growth drove them forth to the enlarged quarters they now occupy, at Nos. 123-133 Washington avenue. These were years of hard work and many discouragements to the young partners, as their road was not always smooth, nor the going easy. They met with losses that would have discouraged less determined, courageous men, but adversity only nerved them to redoubled effort. That they are now rated among the leading retail merchants of Scranton is entirely due to their superior business ability, their indomitable courage, and their progressive, modern methods. No fortunate chance turned the tide in their favor; on the contrary, they began under the handicap of insufficient capital and a new, untried location. But, shoulder to shoulder, they battled, finally overcoming adverse fortune and gaining the topmost rounds of the ladder of mercantile fame. They have ever been leaders in all forward selling movements and in matters of store government. They were the first to demonstrate the advantage of shorter shopping hours. The latest progressive movement which they have inaugurated is early closing and Saturday half-holidays, from June 15 to September 15, thus giving three months of such privileges to their clerks, instead of the customary two months of July and August. In many other matters requiring a leading champion they have had the courage of their convictions, never fearing to defy established custom and to lead in new and untried methods that their judgment or public spirit approved of. The firm gives full credit to their sales force for its part in the upbuilding of their large and successful business and in return have done all in their power to improve working conditions and to make the hours of duty in the store pleasant and comfortable for the one hundred and twenty-five salespeople employed.

Bernard P. Connolly, the senior partner, was born in Trenton, Province of Ontario, Canada, January 3, 1859, son of James and Mary (Connor) Connolly. He was educated in the public schools and early began mercantile life as a clerk. He became manager of a store in Warkworth, Ontario, continuing in that capacity three years. In 1879 he came to Scranton, entering the employ of R. M. Lindsay, proprietor of the Boston Store. For thirteen years he remained with Mr. Lindsay, gaining a knowledge of merchandise and developing plans for his own future. In 1892 he formed a partnership with H. Clifford Wallace and soon afterward they launched their little bark on the stormy sea of business. That the sturdy craft made a prosperous voyage and reached a safe haven has already been told.

Mr. Connolly is fond of out of door life, is a member of the Scranton Club, Scranton Bicycle Club, Scranton Canoe Club, Benevolent and Protective Order of Elks, Catholic Club, and Liederkrantz. Pleasing in his personality, he has many friends who appreciate his manliness of character as well as his excellent business qualifications. Mr. Connolly is unmarried.

---

#### H. CLIFFORD WALLACE

H. Clifford Wallace, of the firm of Connolly & Wallace, was educated in the public schools of Middletown, New York, and began business life as clerk in his father's dry goods store in Middletown, continuing until 1882, when he sought the wider field of opportunity offered by Scranton. He entered the employ of Cleland, Simpson & Taylor, spending with that firm ten fruitful and valuable years preparing for the brilliant mercantile career that has been realized in the years since 1892, when he formed his present partnership with Bernard P. Connolly, with whom he has worked so successfully in establishing





*C. C. Rose*

the firm of Connolly & Wallace. Mr. Wallace enjoys the social and athletic pleasures of club life, holding membership in the Scranton, Country and Bicycle Clubs, and is a member of the Scranton Board of Trade. In religious faith he is a Methodist, belonging to the Elm Park Congregation. While he has outside business connections, the only organization he serves officially is the Union National Bank of Scranton, of which he is a director.

Mr. Wallace married, April 18, 1894, Julia, daughter of Sylvester Shively, of Scranton. Children: Julia, Jean, Eleanor, Harvey. The family home is at No. 814 Clay avenue.

---

#### CHARLES C. ROSE

While Scranton, as a manufacturing center, holds high place among the cities of its class in the United States, the foundation of its prosperity is, of course, in the value of the mineral deposits in the neighboring region, a large part of which is anthracite coal. One of Scranton's foremost citizens, occupying a prominent position in the development of this industry is Charles C. Rose, whose career is herein recorded.

The Rose family has long been seated in New York, and it was in this state that William C., father of Charles C. Rose, was widely known. He was intrusted with the supervision of the construction work on a section of "Clinton's Ditch," better known as the Erie Canal, a commission he executed faithfully and well. He remained here about two years, and after that was employed by the Delaware & Hudson Canal Company as division superintendent, remaining in this position the rest of his life and died at the age of sixty-seven, residing at Port Jervis, New York, at the time.

He married Lovina Shimer, and to this union were born six children, three sons and three daughters, of whom Charles C. was the youngest.

Charles C. Rose, son of William C. and Lovina (Shimer) Rose, was born in Rosepoint, New York, July 20, 1847. His education was obtained in the public schools and at a preparatory academy at Norwalk, Connecticut. His relation with Scranton industries and affairs began in 1867, when he accepted a position as private secretary to Thomas Dickson, vice-president of the Delaware and Hudson Company. After a short time he left Scranton, going to New York where he followed the profession of civil engineer, serving during this time about five years on the Delaware & Hudson Co.'s Lake Champlain railway extension. In 1880 he was employed by the Delaware, Lackawanna & Western Railroad Co. upon the construction of their new railroad from Binghamton to Buffalo. After this he was moved to Scranton where he was in charge of the engineering work, including maintenance of way, for the Delaware, Lackawanna & Western Railroad Co. until 1905. He was then appointed superintendent of the coal department of the Delaware & Hudson Co., an office he still holds. His position carries with it great responsibility, as the coal interests of the company are vast and cover a great deal of territory, the details requiring constant and minute attention.

Mr. Rose's other business connections are as director of the Scranton Bolt and Nut Company and of the Peoples National Bank. His social relations are with the Scranton Club, the Country Club and the Engineers Club. In political belief he supports the Republican party, in whose principles he is a firm believer.

In 1879 he was married to Emma K. Watson, of Port Kent, New York, and a son, Dr. Emmason C. Rose, of Brooklyn, New York, was born in the autumn of 1881. Her death occurred in 1881. In 1888 he married Emma, daughter of

A. H. Vandling, of Scranton, Pennsylvania, and a son, Vandling D., who is now a student in the Sheffield Scientific School of Yale, was born in 1894.

Mr. Rose fills a position as one of the substantial, successful business men of Scranton, of proven ability; and forms one of the company upon which foundation of the city's prosperity has been laid.

---

#### GEORGE SANDERSON

The Sandersons are among the old Massachusetts families, where the records show them as early as 1643. By marriage and intermarriage they relate to many of the old and prominent families of New England, the Kingsburys, Spaldings, Brownes, Gardners, and others. The Revolutionary ancestor of George Sanderson was Captain Simon Spalding, who enlisted from Pennsylvania and saw much active service. He attained the rank of captain in the Revolutionary army, and afterward was made a general of militia, by which title he was more generally known.

Edward Sanderson, the progenitor of the family in America, is mentioned in early records, found in Hampton, Massachusetts, from which place he moved to Watertown, Massachusetts, as early as 1643, where, October 15, 1645, he married Mary Eggleston. He was of English descent, but it is not known whether he was born in England or in Massachusetts. The best evidence is to the effect that he was born in England and was the first of his name to come to America.

Deacon Jonathan Sanderson, son of Edward Sanderson, was born in Watertown, Massachusetts, September 15, 1646, died September 3, 1673. He married, in Cambridge, Massachusetts, October 24, 1669, Abiah, youngest daughter of Ensign Thomas and Hannah (Bartlett) Bartolf, of Watertown. They had issue.

Samuel Sanderson, sixth child of Deacon Jonathan Sanderson, was born May 28, 1681, was killed by a stroke of lightning, July 8, 1722. He married, April 3, 1708, Mercy Gale, and settled in Watertown.

Abraham Sanderson, son of Samuel Sanderson, was born in Watertown, Massachusetts, March 28, 1711. He married, December 6, 1733, Patience Smith and they were the parents of thirteen children. They settled in Lunenburg, Massachusetts.

Jacob Sanderson, fourth child of Abraham Sanderson, was born in 1738. He married Elizabeth Child and had four children.

Jacob (2) Sanderson, son of Jacob (1) Sanderson, married Elizabeth Childs and had issue. They resided in Lunenburg, Massachusetts.

Jacob (3) Sanderson, youngest child of Jacob (2) Sanderson, was born October 17, 1780, in Lunenburg, Massachusetts, died December 14, 1853. He married, November 12, 1807, Jerusha, daughter of Captain Lemuel Gardner, of Boston, and settled in that city. Captain Gardner was the first commander of that famous military organization, the Ancient and Honorable Artillery Company of Boston. Jerusha Sanderson died June 18, 1843.

Hon. George Sanderson, second son of Jacob (3) Sanderson, was born in Boston, Massachusetts, February 25, 1810, died in Scranton, Pennsylvania, April 1, 1886. He was educated at the Boston Latin School. After leaving school he went to New York City, and was there employed for a time in the store of a relative. From there he went to Geneva, New York. He married a daughter of Colonel Joseph Kingsbury, a large land-owner of Sheshequin, Bradford county, Pennsylvania. This led Mr. Sanderson to Towanda, the county seat, where he entered upon the practice of law. He soon became known as one of the leading lawyers of the county, being elected district attorney and serving

for six years, resigning to attend to his large private business. Entering actively into political life, he was elected state senator from Bradford county in 1853. In the senate in that year he made the acquaintance of Colonel George W. Scranton, with whom he co-operated in securing needed legislation, which was deemed necessary to insure the future of the then infant city of Scranton. Mr. Sanderson visited that growing city in 1854 and in the following year purchased the Elisha Hitchcock farm, built a handsome residence, and soon after became a resident of Scranton. The site of his first residence is now covered by the magnificent building of the Scranton Young Men's Christian Association. His first business enterprise in Scranton was the organization of the banking house of George Sanderson & Company, the firm consisting of himself and brother-in-law, Burton Kingsbury. This was a private bank, that later was merged with the Lackawanna Valley Bank, and still later into its present corporate form, The Lackawanna Trust and Safe Deposit Company, one of the strong, conservative, financial institutions of Scranton. He personally threw himself with all his energy into the development of the city of Scranton, as a real estate proposition. He laid out and graded beautiful streets through what was then farm property, and the result of his activity may now be seen on Washington, Adams and Wyoming avenues from Spruce to Vine streets, and in the handsome houses and beautiful grounds of the residential sections of Scranton. He donated the lots upon which the high school building was erected, and aided churches and philanthropic enterprises. He was twice elected burgess of Scranton before it became a city. Having disposed of most of the Hitchcock farm, he decided to retire from active business and soon after moved to Germantown, Pennsylvania. He could not, however, get completely out of the harness, and soon afterward became president of a coal company with offices in Philadelphia. Selling out to the Reading Coal Company, he returned to Scranton and purchased a tract of land in the northern portion of the city, now called Green Ridge. By the construction of the Providence and Scranton Street Railroad, he drew to the new suburb a community of taste and refinement, erecting a mansion and continuing to reside there until his death.

George Sanderson married, at Sheshequin, Bradford county, Pennsylvania, Marion W. Kingsbury, born September 30, 1816, died at Scranton, Pennsylvania, June 23, 1886, soon following her husband, who died in April of the same year. She was a daughter of Colonel Joseph Kingsbury, of Sheshequin, Bradford county, Pennsylvania. Four children survived Mr. and Mrs. George Sanderson; James Gardner; George, of whom further; Anna K.; Marion, married Edward B. Sturgess. Hon. George Sanderson died universally regretted. He was a sound, safe, public-spirited man, and to him Scranton owes a debt of gratitude for a wise and artistic development of her suburbs and residence streets. His sons have worthily maintained their father's reputation and are active business men of Scranton. James Gardner, the eldest son, was born in Towanda, Bradford county, Pennsylvania, and lived the greater part of his life in Scranton; was a graduate of the Van Rensselaer Polytechnic Institute, of Troy, and was by profession a civil engineer; he was interested in the Union Switch and Signal Company before it became a Westinghouse property, and in the early development of Portland Cement manufacture, the rotary kiln having been first used by him; he married Eliza McBair, of New York.

Colonel George (2) Sanderson, son of the Hon. George (1) and Marion W. (Kingsbury) Sanderson, was born at Towanda, Bradford county, Pennsylvania, August 22, 1847, and for over half a century has been a resident of Scranton, Pennsylvania. He was graduated from the Scranton high school and

from the Pennsylvania Military Academy at Chester, Pennsylvania. He read law in Philadelphia under the preceptorship of Samuel Robb, entered Harvard Law School, and was graduated in the class of 1869, at the unusual age of twenty-two years. He practiced his profession in Philadelphia for two years, in 1873 locating permanently in Scranton, where he was soon recognized as a lawyer of high qualifications and one well-versed in the law. He was the leading attorney in several important cases, notably: Sanderson versus the Delaware, Lackawanna & Western Railroad, in which he obtained establishment of the legal principle that lease of coal lands in perpetuity was in effect a sale and that the lessee, as a consequence, was liable for the taxes. This was a far-reaching decision, affecting all perpetual coal land leases in the state, and was appealed to the Supreme Court, which affirmed the validity of the principle, for which Colonel Sanderson contended at every stage in the lower courts. While always actively engaged in his professional work, he has other and varied interests. He has long been a director and vice-president of the Lackawanna Trust and Safe Deposit Company, the oldest in the city. He succeeded his father in the management of his Green Ridge property, the beautiful suburb of Scranton. He has been, since his father's death, president of the Forest Hill Cemetery Association, and gave eight years of membership to the National Guard of Pennsylvania, from which he gains his title of colonel. He first served with the Scranton City Guards, afterward merged into the Thirteenth Regiment, as a private in Company D. He was the warm advocate of rifle practice for the Guard; served upon the governor's staff, as inspector of rifle practice, and in that position was instrumental in developing that feature of the service to a degree that attracted to Pennsylvania the favorable criticism of National Guardsmen from all over the country. For eight years Colonel Sanderson served the Thirteenth ward in Scranton Select Council, a large part of the time as president of that body, and until recently was president of the sinking fund commission. For the past decade he has given little attention to his profession, devoting his time to his business interests and to recreation. Colonel Sanderson is an influential Republican but not an office seeker, and beyond the demands of his city and her interests he has never entertained any proposition that involved personal office-holding. He is a member of the Masonic fraternity and a Knights Templar. His social clubs are the Scranton, Country, Green Ridge Wheelmen, Germantown Cricket, University of Philadelphia, and the New England Society of Northeastern Pennsylvania, of which he is an ex-president.

Colonel George Sanderson married, November 28, 1871, Lucy Reed Jackson, born in Boston, Massachusetts, May 30, 1846, daughter of Charles and Maria Louisa (Reed) Jackson, of the ninth generation from the emigrant ancestor, Abraham Browne, of Swan Hall, England. Children of Colonel and Mrs. George Sanderson: 1. Edward Spalding, a graduate of Cornell University, engaged in business at Waterbury, Connecticut; married Frederika Catlin, and has a son Edward. 2. Charles Reed, a graduate of Cornell University, engaged in business in New York City; married Edith S. Brooks. 3. James Gardner, a graduate of Cornell University and of the Chicago Law School, a practicing lawyer of Scranton; married Beatrice D. Tyler and has a son, James Gardner Jr. 4. Helen Louise. 5. Marion K., married to Charles G. Bartlett Jr., now residing in Glen Ridge, New Jersey. 6. George Jr., a graduate of the law department, Cornell University, class of 1910, now a practicing lawyer in Rochester, New York.



## MORTON W. STEPHENS

The father of Morton W. Stephens, the Hon. A. Wesley Stephens, was for several years the representative of Wyoming county in the Pennsylvania legislature, in which body he capably represented his district and left behind him a record of able statesmanship and honorable motive that is a credit both to him and to the district that so wisely chose him to guard its interests and to act for it in affairs of state. A. Wesley Stephens was born in Nicholson township, Wyoming county, Pennsylvania, and for many years was a farmer later becoming a contractor and builder and conducting operations in Nicholson borough where he still resides. He married Emily D. Tiffany, who died February 24, 1911, daughter of Orvil Tiffany. The Tiffany family is of English descent and were early settlers in Susquehanna county. Children of A. Wesley and Emily D. (Tiffany) Stephens: Fannie, married F. L. Foster, of Nicholson, Wyoming county, Pennsylvania; Ivadean, married J. W. Koerber, of Wilkes-Barre, Pennsylvania; Beatrice, resides in Nicholson; Morton W., of whom further.

Morton W. Stephens was born in Nicholson township, Wyoming county, Pennsylvania, April 9, 1876. He attended the public schools of his birthplace and prepared for college at the Keystone Academy, whence he was graduated in 1897. He then obtained a teacher's position in Susquehanna county and was a disciple of that profession for five years, during that time holding the office of editor of the county educational paper. In 1901 he resumed his studies, attending Cornell University, and then entered the law school of the University of Pennsylvania, whence he was graduated LL.B. in 1907. While in college, part of Mr. Stephens' course was instruction in public speaking and in this he took special interests, cultivating his natural forensic talents with such success that he was awarded a place upon the debating team representing the university in the inter-collegiate debates. He had begun this work at Keystone Academy, where he took successful part in several oratorical contests. In the same year that he was graduated from the University of Pennsylvania he was admitted to the bar and has been associate editor of the American Law Register.

He married, in 1907, Alta F. Finn, daughter of Nelson M. and Myra (Green) Finn, of Foster, Pennsylvania. Nelson M. Finn is a member of the family of that name that settled in Clifford township, Susquehanna county, Pennsylvania. They have one child, a daughter, Freda Eloise, born December 22, 1912. Thorough, conscientious, and exact in the preparation of a case, it is in its presentation that Mr. Stephens excels, his well balanced, musical, forceful and convincing sentences conveying the exact shade of meaning intended. Realizing the often salutary effect of a dramatic speech, he never descends to cheap emotionalism, but confines his efforts to influencing the reason, rather than the emotions, of a jury. He is held in high esteem by his legal brethren, with whom he has formed many firm friendships. He affiliates with the Masonic Order, the Independent Order of Odd Fellows, the Acacia Fraternity, International Debating Association, and Scranton Rotary Club. His political faith is Republican, and in religious belief he adheres to the doctrines of the Methodist Episcopal Church.

## HENRY S. ALWORTH

This family dates from the earliest settlement in the region now included in the borough of Dunmore, William Alsworth, a young shoemaker, settling at the "Four Corners" during the summer of 1783. The descendants of the hardy

old pioneer have dropped the "s" from the name in some branches, spelling the name Alworth. The settlement at the Four Corners was accidental, Mr. Alworth being there overtaken by night, and deeming it a suitable camping-place. He had been searching for a location in the Wyoming Valley, on land owned by Connecticut, but, liking the Dunmore locality, determined on settlement there. Bringing his wife and family with him in a covered wagon, he took up land and built a log-cabin from the trees it was necessary to remove to obtain room for dwelling and garden, utilizing the wagon as a sleeping-place during the erection of the cabin. Between his cabin and the "Lackawa" settlement on the Paupack, twenty-four miles distant, there stood but two cabins, one at Little Meadows, the other "Cobb's," both kept as houses of entertainment. There were many emigrants passing the cabin, needing convenient places of rest and refreshment, therefore quarters were provided for the entertainment of such passers-by as chose to avail themselves of the privilege. The larder of the old inn was supplied by the rifle of the proprietor, all manner of wild things of the forest falling before his deadly aim. For two years he had no neighbors, but in the summer of 1785 others came, and Bucktown, or the Corners, became a place of some local note. William Alworth kept the old inn in the forest until his death, his wife continuing it for several years longer. "Widow Alworth's" being a favorite stopping-place. The old tavern, with its round swinging sign and long low bar-room, for years a spot of historic interest, finally was destroyed by fire. He was a genial host, and joke and kindly word cheered the weary and often discouraged wayfarer. Here he reared his family and left a posterity who honor his memory and worthily bear the name.

Henry S. Alworth, of Scranton, is a great-grandson of the old pioneer son of Milton S. and Nancy Jane (Sweet) Alworth. He was born in Clifford, Susquehanna county, Pennsylvania, January 31, 1869, but when he was two years of age his parents, Milton S. and Nancy J., moved to Harford, a post village of the same county, about thirty miles north of Scranton. Here his youth was spent attending the graded school and working on the farm. Later he entered Mansfield State Normal School, whence he was graduated, class of 1889. He began teaching soon after his graduation, and in 1890-91 was principal of the graded school at Bellevue, Lackawanna township, Lackawanna county, Pennsylvania. He then entered the law school of the University of Pennsylvania, whence he was graduated LL.B., class of 1893, and in September of the same year was admitted to the Lackawanna county bar, at once beginning practice in Scranton. He has a large practice in the state and federal courts of the district, having been regularly admitted to practice in all. He has taken a deep interest in public affairs, serving as a member of council in 1898, and in 1912 was the successful candidate of his party for the state legislature.

Mr. Alworth married, February 11, 1897, Florence Louise De Munn, and has a daughter, Natalie.

---

#### MICHAEL A. MCGINLEY

There is a notable record of achievement in the life of Michael A. McGinley that goes far toward proving the value of ambition, determination and perseverance, and what these qualities will do for the formation of a career. From the following chronicle may come a gleam of hope or inspiration to youths whose early circumstances seem to forbid a look above the common place to the higher level of existence.

Michael McGinley, son of John and Margaret (O'Donnell) McGinley,





Matthew Stiff.

was born at Mauch Chunk, Pennsylvania, in 1873. All of his school training was obtained before the age of fourteen years, when he apprenticed himself to the machinist's trade. After three years of service in that occupation he entered the railroad employ as a fireman, continuing so for two years. Most of his spare time and all of his evenings during this period had been devoted to study, and in 1890 he obtained a position as court stenographer. The nature of his duties allowed him much leisure time and this he utilized by entering the office of O'Brien & Kelly as stenographer and law student. His studies were so diligently pursued and to such excellent result that his admission to the Lackawanna county bar was obtained, after passing a rigid examination in June, 1893. So rapid was Mr. McGinley's rise in his chosen profession that in 1896, when he was but twenty-three years of age, he was placed in the office of city solicitor, an office requiring an exhausting knowledge of municipal law. His term as solicitor of Scranton was a very busy one, as well as most successful. He personally conducted all the litigation in which the city was involved, delegating nothing to assistants and has a record singularly free from reverses of any kind. As earnest of the industry and energy which he carried into his daily duties is the fact that while in office he was the author of more than 1100 opinions on municipal questions submitted to him. Still further evidence of the scope of his knowledge and the authoritative nature of his opinions is that not one of the cases in which he engaged in defence of the principles involved in his opinions has been disturbed by an appellate court. In his private practice he has been counsel in eleven cases where the defendants were charged with murder and in none of these was a first degree verdict rendered. It is also a tribute to his legal genius and ability that he received the first acquittal in Lackawanna county in the case of a defendant charged with murder where the commonwealth pressed for a first degree conviction.

Mr. McGinley at one time was a candidate for election to Congress from his district and in a close election was defeated. The record that he has made in his profession would have done ample credit to a man whose entire education and aim in life had been for the law. The fact that by an uphill battle with adversity, buoyed up only by his confidence in himself and the sight of his goal, should give a great measure of satisfaction to the man who looks back upon such a past.

---

#### MATHAIS STIPP

The record of those of the name of Stipp in Scranton has been that they have followed a constructive policy, working results necessary that others may prosper with them. Construction has indeed been the keynote of their efforts, contracting and building being the line followed successfully and with profit by three Stipp brothers. Their businesses have not been parasitic growths, imbedding themselves in and preying upon other industries of the city, but have been those in which achievement is proportionate with labor expended and in which only ability brings success.

Mathais Stipp, son of Ludwig and Mary Anna (Diedrich) Stipp, was born in Rheinfaiz, Germany, November 22, 1864. After obtaining his education in the public schools of his native land he came to the United States, settling in New Jersey in 1883. The year following his landing in this country, he came to Scranton, the city which has since been the scene of his life's work. For one year he held the position in the employ of another, but since 1885 has engaged in business independently, his destinies and fortunes shaped by his own hands, he alone responsible for the ends he has accomplished. In

1892 he added to his contracting and building business, which he had established seven years previous, that of brick manufacture, the product of his factory being 30,000 bricks per day. Not alone in the business world is he regarded as one of Scranton's worthy citizens, but in serving two terms as a member of the common council of the city he placed himself permanently on record as standing for cleanliness in civil life, honor and openness in the administration of municipal finances, and constant co-operation between citizens and their representatives in office for the most efficient form of city government. His fraternity is the Masonic Order, in which he holds the thirty-second degree, and he is a member of Fairview Lodge, No. 369, K. P.

Mr. Stipp married, March 10, 1887, Ellen A. Marguart, and has children: Arthur P., Ezra F., Mathais J., Paul.

#### LOUIS P. WEDEMAN

The story of the founding of the Wedeman family in America reveals an unusual, to say the least, method of immigration, and one that one might well wish to avoid. Daniel Wedeman, a store-keeper and a single man of Hamburg, Germany, had made a trip to London to purchase a stock of goods to replenish his depleted supply, when he was seized by British soldiers, compelled to don an English uniform, and was pressed into the service of that country. He was placed on a transport bound for America, where the war for independence was passing through its birth throes, preparatory to the long, grueling struggle that levied such a heavy toll of lives. Enraged because of the high handed treatment to which he had been subjected, he deserted the British ranks and joined the Colonial forces, entering into the conflict with the double incentive to aid a cause he believed righteous and to avenge his own abuse. He fought throughout the entire war, and after receiving an honorable discharge from the service he decided to remain in the land to which his fate had led him, and purchased 400 acres of land near Providence, being the second white settler in the Lackawanna Valley. He erected a log cabin on the site until recently occupied by Daniel Silkman's home. He married and among his children was Peter.

(I) Peter Wedeman was born in Providence, now North Scranton, Pennsylvania, and there followed the farmer's occupation. He married and was the father of the following children: Daniel, Thomas, John, Henry, Martin Peter, Cyrus, Ensign, Herman, Abiah, married John Hudson, of Carbondale.

(II) Martin Peter Wedeman was born where the borough of Mayfield now stands. He was a farmer throughout his entire life, taking active part in local affairs. He supported first the Whig and later the Republican party, and as the candidate of these organizations held many borough and township offices, among them school director, supervisor of roads and councilman. He married, in Carbondale, Pennsylvania, in 1840, Elizabeth, daughter of Lewis and Elizabeth Jones, born near Merthyr-Tydfil, county Glamorgan, Wales, in November, 1822. The Jones family above mentioned have long been natives of Wales. Children of Martin Peter and Elizabeth (Jones) Douglas: John Daniel, born in April, 1846; David Samuel, born in November, 1849; Louis Peter, of whom further; William H. born in October, 1859; George Edward, born in August, 1863; Ella Elizabeth, born in July, 1865, married W. D. Bryden, a professor in the Carbondale High School.

(IV) Louis Peter Wedeman was born at Carbondale, Lackawanna county, Pennsylvania, March 5, 1850. He obtained his education in the public schools and until he was sixteen years of age lived on his father's farm. He then



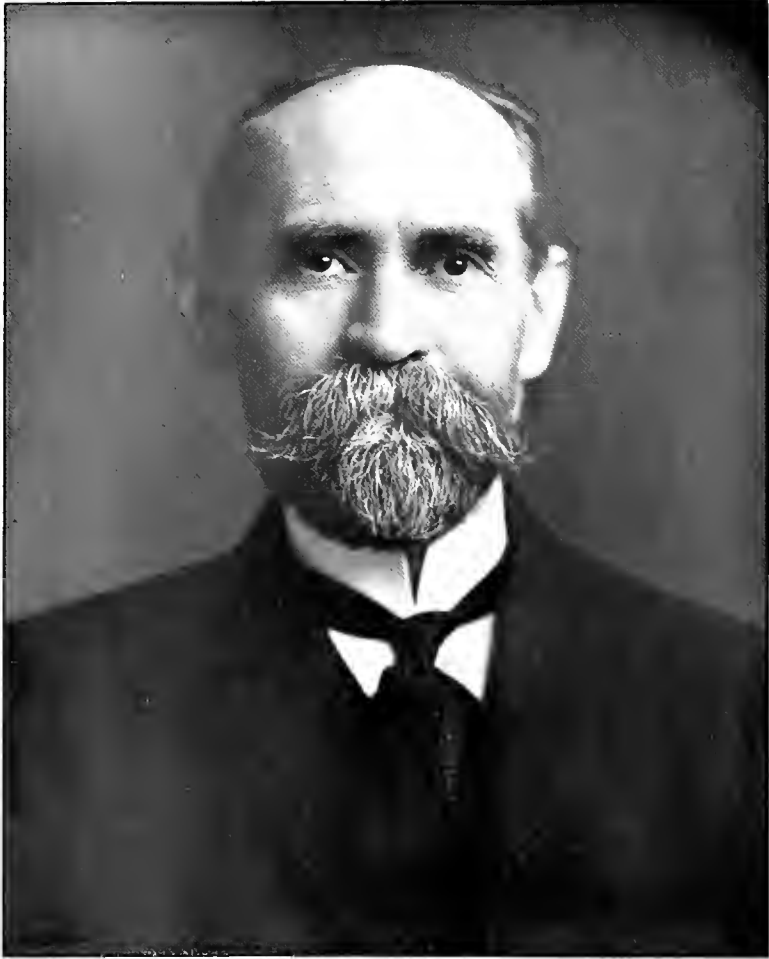

*Geo I Porter*



learned the carpenter's trade, supplementing his income during the winter season by teaching school. After learning his trade and working at it for a time, he branched out in building and contracting operations, in which he met with pleasing success. Inclining toward the law, he abandoned the business he had built up and began the study of law in the office of Blakeslee & Ainey, at Montrose, Pennsylvania. In this profession he found the vocation for which he is naturally fitted and since his admission to the bar of Susquehanna county in 1890 has been constantly engaged in practice. He has been admitted to all the state courts, and since 1895 has been located in Scranton. In 1890 he was elected justice of the peace of Susquehanna county, at Forest City, and has been burgess of the same borough.

He married, in New York City, December 20, 1898, in the Old Methodist Church, the first church of the Methodist Episcopal denomination in the city, Minette, daughter of Warren and Sarah (Gregory) Barlow. Warren Barlow is in the stone business in Wyoming county, Meshoppen, in that county, being the birthplace of Minette (Barlow) Wedeman. Children of Louis Peter and Minette (Barlow) Wedeman: Louis W., born July 15, 1900; John D., born December 15, 1903.

---

#### JOHN T. PORTER

The prominence of John T. Porter in the financial and commercial affairs of the city of Scranton and the Lackawanna Valley is amply attested by his long official connection with various of their most important corporations, prominent among them being one of his own founding, the John T. Porter Company, wholesale grocers, the largest house of its class in the entire north-western part of Pennsylvania, and whose trade extends into the adjoining states of New York, New Jersey and Delaware. A fact which further testifies to his ability, enterprise and public spirit is his active identification with the Scranton Board of Trade, almost from the day of his arrival in the city, and of which excellent organization he has been president for two terms.

Mr. Porter is a native of Delaware, born in Middletown, May 24, 1850. Here was also born his father, Abel J. Porter, who passed his life there as a farmer and miller. He was a member of the Methodist Episcopal Church. He married Sarah Ann Van Pelt, who was of Dutch extraction, her father, Jesse Van Pelt, being a native of Holland. The children of Abel J. Porter were: Lydia; Ann Mary, who became the wife of Thomas Price, of Maryland; John T., of whom further.

John T. Porter received his education in Smyrna (Delaware) Seminary. At the age of nineteen years he was well equipped to make his beginning in an independent career, and immediately after leaving the seminary went to New York City, where for five years he was engaged as salesman in a foreign fruit importing house. Here he served with such ability and fidelity as to win the confidence and esteem of his employers, while the experience which he obtained was invaluable to him personally, and afforded him a substantial foundation for an early establishment in business upon his own account. In 1875 he located permanently in Scranton, where he opened a wholesale grocery business at Nos. 26 and 28 Lackawanna avenue, a site which his house has uninterruptedly occupied to the present time. While catering to all immediate demands, he was constantly developing his business into larger channels, and added to his lines of goods large quantities of his own direct importation from foreign markets. Handling every description of staple and fancy groceries, canned goods, produce and fruits, he made his house a rival in a large field of those of the more pretentious metropolitan centres. He conducted this great

enterprise under his own individual name until 1903, when he effected its incorporation under the style of the John T. Porter Company. This house gives constant employment to more than thirty employes, many of whom are heads of families.

While it would seem that the upbuilding and management of so large an enterprise would fully tax the capabilities of any one person, Mr. Porter's unbounded energy and activity have found other avenues in the part he has taken in connection with numerous other large undertakings, all of which are important factors in the business of the community. He was one of the original incorporators of the Traders' National Bank, served long upon its directorate, and has been president since 1895. This bank, organized in 1890, with a capital of \$250,000, is recognized as among the safest and most prosperous of the financial institutions of the city. It has afforded judicious and valuable support to numerous commercial and industrial enterprises of merit, and in all ways has contributed in large degree to the promotion of the material interests of the community. Associated with Mr. Porter in the officary are the following named gentlemen of acknowledged financial and personal standing: J. J. Jermyn, vice-president; M. J. Murphy, cashier; directors: H. H. Brady Jr., Robert W. Beadle, F. L. Belin, David Bois, Joseph J. Jermyn, Cyrus D. Jones, Edward S. Jones, M. W. Collins, H. C. Manchester, Charles P. Matthews, John T. Porter, R. H. Patterson, H. Jennings, R. E. Weeks, James G. Shepherd. Mr. Porter is treasurer and director in the Mississippi Central Railroad, and holds similar relations with the United States Lumber Company, which has extensive lumbering and other interests in Mississippi, which are being developed into mammoth proportions. Mr. Porter has been for twenty-five years a member of the Elm Park Methodist Episcopal Church, and of its board of trustees. He is independent in politics. He is a highly regarded member of various leading social bodies—the Scranton Country Club, the Southern Society of New York, and the Sons of Delaware in Philadelphia.

Mr. Porter married Harriet Schlager, daughter of the late John Schlager. Of this marriage have been born six children: Elizabeth, who became the wife of R. E. Weeks, of the firm of R. E. Weeks Company, and president of the Scranton Board of Trade; Florence S.; John Kenneth; James Russell; Eleanor.

---

### JOHN W. HOWARTH

In the history of Scranton and her public men, men who have achieved success through their own individual efforts, the direct result of integrity, energy and perseverance, it is meet that mention should be made of John W. Howarth, a member of the firm of Price & Howarth, one of the extensive lumber enterprises of the city of Scranton.

John W. Howarth was born in Pittston, Pennsylvania, November 29, 1853. He spent his boyhood days at Carbondale, attending the schools in the vicinity of his home, supplementing this knowledge by a course at Wyoming Seminary, thus acquiring an excellent education. His first employment was in the transportation department of the Lehigh Valley Railroad, with which corporation he was connected for ten years. He then took up his residence in Scranton, Pennsylvania, becoming connected with the firm of Swan & Price, the senior partner being Colonel Price, his brother-in-law, and at the expiration of three years Mr. Howarth purchased an interest in the firm, and upon the death of Mr. Swan the business was continued by Colonel Price and Mr. Howarth, the name being changed to Price & Howarth, its present style. Colonel Price died in 1892, his estate continuing to hold interest up to the

present time. The business is that of wholesale and retail lumber, their lumber yard covering the entire block between Washington, Poplar and Ash streets. The business is one of the leading enterprises of that thriving city, giving employment to a number of hands, thus adding to the growth and development of that section of the city. In addition to this other business connection, he serves as director of the Scranton Stove Works and the Cross Engineering Company, of Carbondale, and for many years has been a member of the Scranton Board of Trade. He is an independent Republican in politics, and holds membership in the Blue Lodge, Masonic Order. Mr. Howarth has spent the greater part of his life within sixteen miles of the court house in Scranton.

Mr. Howarth married, in 1882, Ina Price, born in Pittston, a sister of Colonel Price, aforementioned, and daughter of Samuel and Zillah (Armstrong) Price. Mr. and Mrs. Howarth are the parents of two children: Marian and Helen. The family occupy an enviable position in the social circle of Dunmore, where they reside, being honored and respected by all who know them for their many excellent characteristics. They are active and prominent in all worthy causes, ever ready and willing to contribute their full share toward the betterment of mankind.

---

### JOHN SIMPSON

The history of the merchants of Scranton, reveals that fact that in nearly every instance, their beginnings were small and that the largest and most prosperous firms of to-day are composed of men who have worked their way from the foot of the ladder to the top most rounds of commercial success. The present head of the Cleland-Simpson Company furnishes a striking instance of how a clean living, ambitious young man may overcome the heaviest handicap, and reach success through a strict adherence to the three cardinal virtues, work, perseverance and honesty.

John Simpson, president of the Cleland-Simpson Company, was born in Stonehaven, Scotland, January 7, 1852, son of Alexander and Margaret (Logan) Simpson. Until fourteen years of age he attended the parish school, then was apprenticed to a draper (dry goods dealer) with whom he remained three years. At the age of seventeen years he came to the United States, locating in Rochester, New York, there entering the employ of Sibley, Lindsay and Curr. After eight months in their employ, he came to Scranton as clerk in the newly opened "Boston store." He remained in that capacity until 1873, when he joined forces and capital with John Cleland, and opened a dry goods store in Danville, Pennsylvania. They conducted a successful business there until 1876, when Mr. Simpson leaving his partner in charge of the Danville store, returned to Scranton as a partner with Lindsay and Liddle, proprietors of the Boston store. About three years later, still in partnership with John Cleland, he opened a dry goods store in Pittston, Pennsylvania, which proved a successful venture from the start. A few years later they sold their Danville store and opened a similar store in Scranton, concentrating their energies on the Scranton and Pittston establishments. The firm had now passed through the formative, experimental stage and had proved their ability to conduct large business undertakings, with judgment and profit. Deciding upon a plan of expansion, they admitted a former employee, David E. Taylor, to a partnership, placing him in charge of a new branch store at Allentown. A few years later this branch was sold, a store having been opened in Carbondale, which later was also sold. Later the business was incorporated as the Cleland, Simpson Company, the present officials being: John Simpson, president; Harry Simpson, vice-president; U. A. Noble, secretary and treasurer. The firm employ

three traveling salesmen in their wholesale department, and in all their departments about 200 people. An idea of the growth of this business may be formed from a comparison of their original, with their present quarters. The original building fifty by one hundred feet, one story in height, was erected by Horace B. Phelps; was sold by his estate to Elias Morris, from whom the present owners purchased it. The present building is 100 feet front, 167 feet in depth, five stories in height with a basement; the new addition built in 1913 being six stories in height. In addition to his private business and duties as the head of the Cleland-Simpson Company, Mr. Simpson is a director of the Scranton Lace Curtain Company.

This showing of the activity and success of the strange young Scotchman in his forty years of business life in Scranton, stamps him as a man of rare business genius, backed by an untiring energy, and ambition that would not be satisfied with even moderate success. Unquestionably, Mr. Simpson deserves a place among the leading merchants of Scranton, and none more worthily or justly bears the title of a "self-made" man.

Mr. Simpson married, in February, 1877, Elizabeth, daughter of Jacob Stewart, of Danville, Pennsylvania; children: Clara J., married Urban A. Noble, secretary and treasurer of the Cleland-Simpson Company; Florence, Helen E., married Charles Manaces, of San Francisco, California.

---

#### EDWARD PAYSON KINGSBURY

Edward Payson Kingsbury, a public-spirited citizen, and a man whose honorable business methods and frank and genial manner have won for him many friends in the city of his adoption, was born at Honesdale, Pennsylvania, May 19, 1834, the son of Hon. Ebenezer Kingsbury and Elizabeth Harlow (Fuller) Kingsbury, his wife.

On both his father's and his mother's side, Mr. Kingsbury comes from a long line of distinguished New England ancestry; they both reach far back into early Colonial days, and embrace a large number of those who were well-known in the professions and in public life; many of them were clergymen. These ancestors were conspicuous for their services to the American cause during the Revolutionary War; among the latter was Captain Ebenezer Kingsbury, of Coventry, Connecticut. It is recorded of him that "he was a deacon in the church and a much valued citizen; representative in the general assembly of the church continuously from 1754 to 1780;" at the same time he was captain of a company of militia. It is said of him that during a critical period of the Revolution he returned from the session of the general assembly on a Saturday to work for the soldiers. His daughter, Priscilla, moulded bullets from the lead clock weights, and his son, Joseph, made and baked biscuits, both on the Sabbath; "sand bags were substituted for the lead weights in the family clock, and on Monday he returned to his post of duty, his saddle-bags balanced on one side with food for the soldiers, and on the other with bullets for their enemies."

Mr. Kingsbury's grandfather was Rev. Ebenezer Kingsbury, a graduate of Yale College in the class of 1783. He had his first charge at Jericho, Vermont, and in 1810 came to Harford, Pennsylvania, where he preached and labored for seventeen years, traveling by horseback through the wilderness embraced by the counties of Wayne, Susquehanna, Bradford and Luzerne, going by Indian trails and blazed bridle paths. He died, greatly beloved and mourned at Harford, Pennsylvania, March 22, 1842. His wife was Hannah, daughter of Rev. Noah and Hannah (Payson) Williston, of West Haven, Connecticut.



*E. J. Kuyper*



She was directly connected with the distinguished Williston family of Massachusetts.

Mr. Kingsbury's father was Hon. Ebenezer Kingsbury, who was born in Jericho, Vermont, June 18, 1804, who came with the family to Harford, Pennsylvania, in 1810, where he received his education. He studied law with Hon. William Jessup, of Montrose. On being admitted to the bar he moved to Honesdale, Pennsylvania, where he soon took a leading position in the practice of his profession. In 1830 he became deputy attorney general of the state. From 1833 to 1840, in addition to his large law practice, he was the editor and proprietor of the Wayne County Herald, the leading Democratic newspaper of Northern Pennsylvania. He was elected to the senate of Pennsylvania for four years from 1837 to 1841, representing the counties of Luzerne, Monroe, Pike and Wayne. During this term he was elected speaker of the senate and was, by virtue of this office, next the governor in rank and succession. His journeys each year to Harrisburg took several weeks, the route being by stage to Philadelphia, thence by canal to Harrisburg, and required his absence from home all winter. He was a ruling elder in the Presbyterian church of Honesdale and superintendent of the Sunday school. He died April 15, 1844, a young man barely across the threshold of life, with a great future of promise and usefulness before him. It was said of him, "A man righteous before God in all the relations of life." He married Elizabeth Harlow Fuller, daughter of Edward and Hannah West Fuller, November 24, 1829. Mrs. Kingsbury was born in Norwich, Connecticut, January 1, 1805, and was a lineal descendant of Dr. Samuel Fuller, the beloved physician of the "Mayflower." She died in Scranton, Pennsylvania, June 13, 1871.

Their son, Edward Payson Kingsbury, was born at Honesdale, Pennsylvania, May 19, 1834. He received his education in the common schools and in the academy in Honesdale, remaining a pupil until ten years of age, when, owing to his father's death, he was obliged to leave school and obtain employment in Honesdale. This he found with a firm of tobacconists, H. E. & J. N. Conger, where he remained one year, and then went into the drug store of Dr. Dwight Reed, after which he entered the hat store of John A. Brink, where he remained until he made an engagement with the firm of Scrantons & Platt, to enter their store at Scranton, and commenced work for them February 13, 1850. In 1853 he was transferred from the store to the general offices of the company, by Mr. S. T. Scranton, and was appointed assistant to the chief bookkeeper. Shortly after this he was appointed cashier of the company, and held this position until 1859, when the directors of the Lackawanna Iron and Coal Company, successors to Scrantons & Platt, this firm having been merged into this corporation, June 10, 1853, elected him assistant treasurer of the company. This office he held until 1881, when, after a service with Scrantons & Platt, and their successors, of thirty-one years and six months, he identified himself with the Scranton Steel Company, incorporated in that year, with W. W. Scranton as president, Colonel Walter Scranton, vice-president, and E. P. Kingsbury, secretary and treasurer. In the year 1891 this company was merged into the Lackawanna Iron and Steel Company.

The Tribune Publishing Company was incorporated in 1891, and Mr. Kingsbury was its first business manager. Later he was elected president, vice Everett Warren, Esq., resigned. He helped to organize and became secretary and treasurer of the Enterprise Powder Manufacturing Company of this city. Later on the merging of this company with the E. I. Dupont de Nemours & Company of Pennsylvania occurred and he became a director and auditor of that company. Mr. Kingsbury is now a director in the following companies: The County Savings Bank, the Scranton Gas & Water Company, the Title Guar-

anty & Surety Company, E. I. Dupont de Nemours & Company of Pennsylvania, the Scranton Trust Company.

Mr. Kingsbury has been a lifelong Republican; his first vote was cast in 1856 for John C. Fremont for president, and he has given his vote for the Republican candidates at every presidential election since that time. He was a delegate to the national convention of the Republican party held in Chicago in 1888, when Benjamin Harrison, of Indiana, was nominated for president of the United States. He was appointed a notary public by Governor Curtin, and re-appointed by Governors Geary and Hartranft. He was elected city controller in 1879 and served two terms, up to and including 1883, and upon many occasions has presided at city and county Republican conventions. For two terms he served as jury commissioner of Lackawanna county.

He has been for many years prominently identified with Free Masonry; he became a Mason and member of Union Lodge, Free and Accepted Masons, January 16, 1857; elected junior warden in December, 1857; senior warden in 1858; and worshipful master in 1859, served as such during the year 1860-61-62. In 1863 he was elected treasurer of the lodge, has been re-elected annually since that time, and is now serving his fifty-first consecutive year. Mr. Kingsbury was also district deputy grand master of the Grand Lodge of Pennsylvania for several years, for the county of Luzerne. He is a life member of Lackawanna Chapter, No. 185, R. A. M.; was its high priest for the year 1860, and district deputy grand high priest of the Grand Chapter of Pennsylvania for several years. He is also a member of Coeur de Lion Commandery, No. 17, K. T., and was its eminent commander for the years 1868-69-70. He has also served as treasurer of the Commandery for forty-one years, and was re-elected for the forty-second consecutive time on March 17, 1914.

From the time of his coming to Scranton, when upon the threshold of young manhood, Mr. Kingsbury has been an ardent factor in the social, religious and industrial life of our city. He has not only seen it grow—he has been a lifelong pushing factor in its growth from a wilderness to a great and teeming municipality. Scranton has been fortunate in having a large class of splendid men as its builders, of which Mr. Kingsbury has ever been one of the foremost. He is a member of the First Presbyterian Church of Scranton, and for more than two decades acted as its chorister.

Mr. Kingsbury married Anna Louisa Kressler, daughter of David K. Kressler, of Scranton, February 13, 1861. Their children are: Henry Williston, born December 20, 1861; Emma, born May 28, 1863, died in infancy; Lizzie, born July 18, 1865, died in infancy; Charles Edward, born November 3, 1867; Anna Kressler, born October 12, 1869, became the wife of Richard S. Storrs, of Orange, New Jersey; William Payson, born December 14, 1871, died May 8, 1913. Mrs. Kingsbury was a woman of strong character, charming presence and rare personal qualities. An earnest Christian and active worker in the church, she was an ideal home-maker, than which there can be no higher testimony paid to woman. She made her home a sanctuary for her husband and her children, for which she will be long loved and her memory revered and cherished. She passed to her rest, January 26, 1913.

---

#### MAURICE T. MILLER

Maurice T. Miller, president and general manager of the T. M. Miller Company, manufacturers of undertakers' supplies, is the first of his branch of the family of American birth, Germany having been the home of all previous generations of the name. The origin of the name was probably from



the occupation of an early member of the family, most of our surnames having been derived in that and similar manners.

Theodore M. Miller, son of Otto Miller, and founder of the company of which his son is now the able head, was born in Leipsic, Germany, one of the oldest university cities in the German Empire, in 1848. At an early age he came to this country with his parents, settling in Archbald about 1852. Here his father conducted a general contracting business and also made coffins, as required by the undertakers of the vicinity. In this town Theodore M. Miller attended the public schools and spent his boyhood years. In 1873 he inaugurated the present business at Jermyn, Pennsylvania, twenty years later moving to Scranton. While from a financial standpoint his enterprise was always a success, it was not until he came to Scranton that it began its greatest development, in the course of which it has trebled in size and has taken a position among the foremost houses of its kind in the country.

Theodore M. Miller was in his youth a musician of great talent, and with the proper training, study and instruction would doubtless have become one of the leading violinists of the day. While still a lad in his teens he played first violin in a theatre orchestra. He was the organizer of the Jermyn Band, which at one of the Welsh carnivals of the early days won first prize. Mr. Miller was one of the most widely acquainted men in the Lackawanna valley and was held in universal esteem among those with whom he came into contract in business or social life. Friendly, of genial nature, he possessed the other qualities so often the concomitants of those, quick sympathy and impulsive generosity. He gave liberally to those in need, his gifts being tendered in the spirit of fellowship that took the sting away from the necessity of accepting charity and made the recipient of his bounty his lifelong admirer and champion. There were many in the region through which he traveled and in his home city who blessed his memory and mourned his death as a personal grief. He was fraternally connected with the Independent Order of Odd Fellows, and was a charter member of the local lodge of the Benevolent and Protective Order of Elks. He died in 1906. He married Sarah Foster, a native of England. One of their children died young. The others, Maurice T., of further mention; Gertrude, married J. Hitchcock; Harry A.; Robert R.

Maurice T. Miller, son of Theodore M. and Sarah (Foster) Miller, was born in Jermyn, Pennsylvania, February 17, 1874. He was educated in the public schools, and early in life began to learn the business of his father, working in every department and also as a road salesman. Taught to regard this as his life work he made every preparation possible for the position he now holds, and at the death of his father in 1906, incorporated the business as the T. M. Miller Company, with himself as president and general manager, and M. B. Gay as secretary and treasurer. The latter has since retired from active participation in affairs, his interest now being owned and his office held by H. A. Miller, giving the entire control of the business to the family of the founder. One of the first houses of its kind in Northeastern Pennsylvania, the T. M. Miller Company is backed by a reputation covering years of service performed to the satisfaction of the undertakers of the state. Their catalogue includes all articles needed by undertakers in their business, caskets of all kinds, dry goods, etc. Their field is country wide, seven salesmen traveling constantly in their employ and about 120 undertakers acting as local agents. In addition to this, through the medium of an exhaustive and profusely illustrated catalogue, a large mail order business is conducted. Mr. Miller supervises this business in a competent manner, maintaining the high standard set by his honored father.

Maurice T. Miller is a member of Hyde Park Lodge, No. 333, F. and

A. M., the Benevolent and Protective Order of Elks, and serves on the Scranton Board of Trade. Both he and his wife are members of the Washburn Street Presbyterian Church. He married Mary, daughter of Job Harris, of Scranton, and has two children, Theodore H. and Mary.

Mr. Miller, trained for the position he now occupies, has had little opportunity to display his constructive ability, but in the direction of the business founded by his father shows executive talent that justifies faith in his future achievements, and promises him to be a worthy son of an honored and respected, albeit deeply mourned, sire.

---

#### LUTHAN B. MOSHER

Although a resident of Scranton since 1892, and one of the leading merchants, Mr. Mosher is a native of New York state, where the Moshers and his maternal ancestors, the Dickinsons, are among the oldest families. He is a son of Adelbert and Susan (Dickinson) Mosher, the former for many years a merchant of Trumansburg, New York, where he yet resides.

Luthan B. Mosher was born in Trumansburg, June 8, 1863. He was there educated and resided until he was twenty years of age, then went to Rochester, New York, always a great clothing manufacturing centre, where he learned the trade of garment cutter. After mastering this art he learned the tailoring part of the business, becoming a finished workman in both branches of the merchant tailor's trade, cutting and making. In 1892 he located in Scranton and established a merchant tailoring business in association with Henry D. Hodgson under the firm name of Hodgson & Mosher. In 1894 Mr. Mosher purchased his partner's interest, and later admitted as partner, J. W. Coleman, operating as Mosher & Coleman. Four years later he bought Mr. Coleman's interest and has since continued the business. In 1903 his store was destroyed by fire, in what is locally known as the Young Men's Christian Association fire. He is now located in splendidly appointed quarters on the first floor of the Burr Building, No. 138 Washington avenue, where he conducts a most exclusive and well patronized tailoring establishment. Mr. Mosher is a member of Trumansburg Lodge, Free and Accepted Masons; Royal Arch Masons; Saint Augustine Commandery, Knights Templar, of Ithaca, New York; and of Irem Temple, Nobles of the Mystic Shrine, of Wilkes Barre, Pennsylvania. In Scranton he is a member of the Board of Trade, the Scranton Club and St. Luke's Episcopal Church.

Mr. Mosher married Lois Burr, one of the two daughters of Dr. Andrew E. Burr, for forty years a practicing physician of Carbondale and Scranton. He was born in Gilbertsville, New York, in 1837, died in Scranton, Pennsylvania, October 7, 1900, and is buried in Dunmore Cemetery. He prepared for the practice of medicine and in 1860 located in Carbondale, where until 1875 he continued in successful practice. In the latter year he moved to Scranton where he was in active practice until failing health, only a short time prior to his death, caused his retirement. He was a skillful physician and a good citizen, aiding by his enterprise and foresight in the development of Scranton. The Burr Building on Washington avenue was erected by Dr. Burr against the advice of his friends, but in spite of advice and ridicule he trusted his own foresight and became the pioneer office builder in that block, the site of the building being that of his residence which was removed to make way for the new building. He was well known and popular, had a large practice and a wealth of friends. While in Carbondale he married Miss Phillios, who died in July, 1913.

## EDWARD O. KOLB

In a day when methods and processes of food preparation have become so unclean, unsanitary, and unhealthful, as to necessitate the vigilance of a Pure Food Commission and the most stringent of laws to prevent the introduction of adulterants, preservatives and other deleterious compounds into the articles intended for our consumption; and when the United States Bureau of Chemistry is constantly engaged in analyzing food-stuffs and exposing their illegal ingredients, it is indeed a satisfaction to discover a place devoted to the preparation of an article of food where cleanliness and purity reign supreme. Picture a two-story edifice, built of Avondale marble and brick, 120 by 150 feet, housing Kolb's Bakery. Within, every appliance used in the making of the bread is snowy white; the sides of the building are little more than glass, through which the sunlight streams; the robes of the bakers are glistening white. Fresh air, sunlight, and cleanliness defy the presence of dirt or dust. Here, safeguarded from any contaminating germs, 25,000 loaves of bread are baked daily and sent out to the homes of the Lackawanna and Wyoming valleys, their purchasers assured that here, at least, is a product of purity.

The Kolb family on the paternal side has long been resident in Pennsylvania, while maternally New York has been its home for an equally long time. John G. Kolb was born in Philadelphia, Pennsylvania, died in 1882, aged fifty years. His lifelong trade was that of baker, which he followed independently, for the most part. He was a Scottish Rite Mason, belonging to the Knights Templar. He married Sarah Kaiser, and they became the parents of several children.

Edward O. Kolb, son of John G. and Sarah (Kaiser) Kolb, was born in Philadelphia, Pennsylvania, May 29, 1875. He obtained an excellent education in the public schools, graduating from high school in 1892. He first obtained employment with his three brothers and thoroughly learned the lumber business, abandoning that to learn the baking business, practiced by his father. In partnership with his brother, Robert C., he opened a bakery in Trenton. No sooner was this started upon a successful career and its popularity and permanence assured, than, with his brother, Frank, he went to Reading and there performed the same operation. After this, too, was firmly established, Edward O. Kolb came to Scranton and there built and equipped his present bakery, a model of modern and sanitary methods. In the beginning of the bakery's existence only ten persons were employed, the force having been increased in accordance to the demands of the business until now seventy-five persons are engaged. A most efficient system of distribution is maintained, fifty per cent. of the daily output reaching families in the Lackawanna and Wyoming valleys outside of the city of Scranton. The enormity of the amount of bread baked is well shown by the quantity of flour used in its making, two and a half carloads being converted into the "staff of life" weekly. Mr. Kolb belongs to the Masonic Order and is a member of King Solomon's Lodge, No. 114, F. and A. M., and Melita Chapter, Royal Arch Masons. He also holds membership in the Scranton Bicycle Club. He married Martha, daughter of William Rayer, of Rayersville, Pennsylvania. Children: Sarah E. and Emma.

An excellent organizer, Mr. Kolb has placed his business in Scranton upon a firm and lucrative basis. Catering to the public taste in a manner and by a system that immediately won approval, he has built up in Scranton, as he did in Trenton and Reading, a flourishing trade. Progressive and modern in ideas, he is a valuable acquisition to Scranton society, as his business is to her industrial interests.

## J. SCOTT INGLIS

Now one of the oldest merchants of Scranton, yet in active business, Mr. Inglis can boast of a mercantile experience in four countries, Scotland, England, South America and the United States. Coming to Scranton when a young man of about twenty years, his experience as clerk and merchant covers nearly a half century and as the city has grown and prospered, so has Mr. Inglis.

He was born in Newcastleton, Roxburyshire, Scotland, October 10, 1847, son of Frank and Jeannette (Scott) Inglis, both descendants of old Scottish families, his mother belonging to the same family as Sir Walter Scott, the great novelist. His father, Frank Inglis, was a sheep and wool dealer.

J. Scott Inglis was educated in the parish schools of Newcastleton, and on arriving at a suitable age became a draper's apprentice, serving four years in the town of Hawick. After finishing his years of apprenticeship he spent some time in Manchester, England, as clerk for the firm of Cleaton & Williams, drapers. An opportunity then presented itself, which he embraced, and he is next found in Buenos Ayres, South America. He did not long remain in that city, but ascending the Uruguay river to Roman, he found employment with a beef company, operating a large soladom there, dressing from one to two thousand cattle daily, the carcasses being shipped to England. While in the employ of the beef company, he made the acquaintance of an English commercial traveler who recognized him as a man he had seen in Hicke. They became friends, with the result that the Englishman induced Mr. Inglis to become his assistant in handling the dry goods trade in his South American territory. In 1866 he came to the United States, going to New York City for a short time, then coming to Scranton, being sent here by Samuel Rogers, a brother-in-law of the late Thomas Moore. He was first employed in a store of Mrs. Courtney, then was with Orr Brothers until they went out of business. He next clerked for the firm of Fisher, Sutphen & Whitmore, whose place of business was at the present site of Goldsmith's Bazaar. The next year he spent in the state of Illinois, then returned to Scranton and opened a general store in Dunmore, continuing in business there four years. After selling his Dunmore store he opened a grocery at the corner of Penn avenue and Spruce street, which after three years he sold. He then became a clerk in the store of R. L. Lindsay in the Boston Store, continuing until 1881, when he became manager of the carpet and furniture departments of Williams & McAnulty, who were just starting. Here he gained his expert knowledge of the furniture and carpet trade and not long afterward became a member of the firm of Hazlett & Company, carpet and furniture dealers. After one and a half years he sold his interest to Mr. Hazlett, but remained as manager of the store. During this period he visited his old Scottish home, spending two months in revisiting the scenes of his youth. After his return to Scranton he was manager for H. D. Judd & Company until he established a carpet store of his own at No. 419 Lackawanna avenue, continuing there in successful business for eleven years. In 1906 his store was burned and he did not again resume business until April 12, 1913. He then opened his present store in the new building, No. 428 Lackawanna avenue, where he again engaged in the same lines, furniture, carpets and wall paper. His life has been an eventful one and from boyhood to the present has been one of activity and purpose. He is well known and holds an honorable position in the commercial world. His interests extend beyond his store and are of importance. He was one of the organizers of the Pine Brook Bank and its first president. In political faith he is a Republican, and in religious belief a Presbyterian, belonging to the First Presbyterian Church.



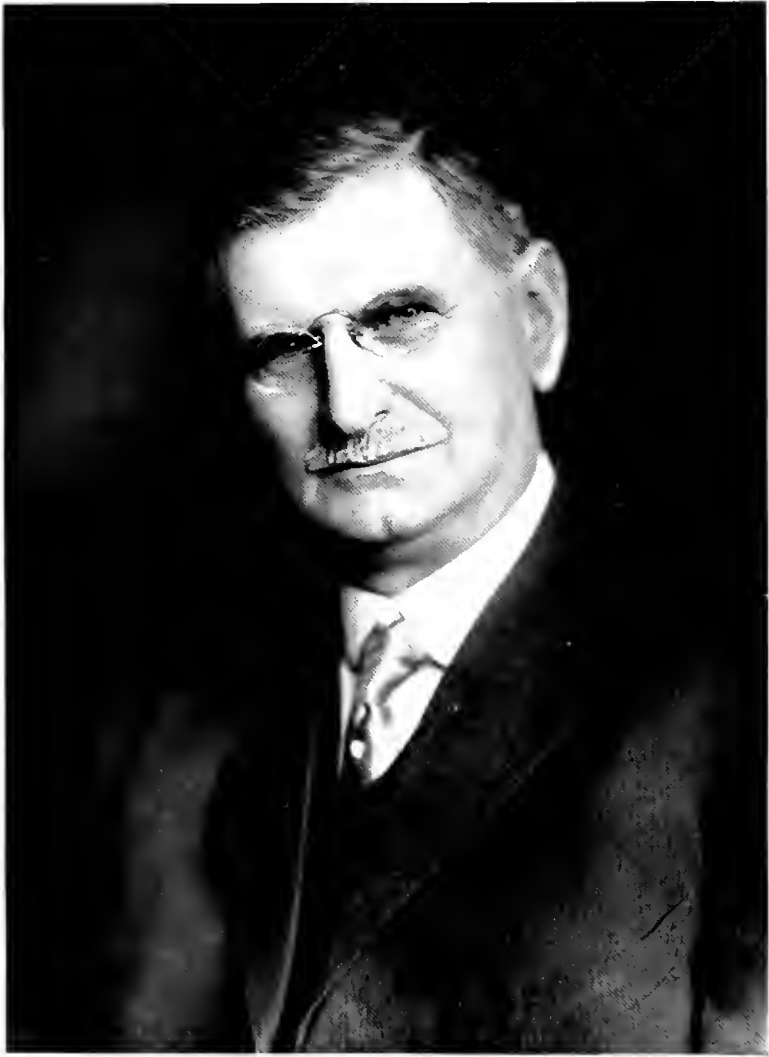

*Philip L. Sylvestre,*

Mr. Inglis married Nancy Victoria, daughter of Abraham Robinson, of Canada. Children: William W., now manager of the Hillside Coal Company of Dunmore; Jessie, married B. E. Miller, of Scranton, head painter of the Delaware, Lackawanna & Western Railroad of East Orange; Helen, married W. B. Jennings, vice-president of the Dime Bank of Pittston and superintendent of the Pennsylvania Coal Company.

---

PHILIP L. SYLVESTER

As a successful inventor and vice-president of the Scranton Button Company, Mr. Sylvester is well known to the industrial world.

Born in 1852, he passed his youth in New York City where he attended public school until his sixteenth year, when he left home and journeyed westward, spending two and one-half years in the then sparsely settled state of Missouri. This separation from the turmoil of city life gave him an opportunity to pursue his studies, and acquire the reading habit, which is still one of his greatest pleasures. Contact with the free life of the early settlers, untrammelled by conventionalities, developed a liberality of thought and freedom from prejudice. In the solitude of the primitive forest he imbibed a love of nature, which still remains a source of keen satisfaction.

He then returned to New York City, and for nearly five years was clerk on the wharf of the National Steamship Company plying between New York, Liverpool and London. Here he availed himself of the fine opportunity offered for studying the free play of the emotions of traveling humanity when under the stress and excitement of arriving and departing vessels. He acquired a good working knowledge of custom house regulations and practice, as well as experience in marine freight, and the discharging and loading of transatlantic steamers. Always of an inquiring and inventive turn of mind, he invented, while in the employ of the company, a reel for winding telegraph tape automatically. The reels were used successfully in the company's main office as well as on the wharf, the manager expressing his appreciation of the apparatus by presenting Mr. Sylvester with a substantial bonus.

His leanings towards industrial inventions, however, became too strong for him to remain in a clerical position. In 1874 he engaged in the manufacture of composition goods. Realizing the importance and advantage of producing a composition that could be used in the manufacture of buttons, dominoes, checkers, knobs, etc., he bent his energies in this direction, and finally perfected a substance that has proved valuable in the manufacture, not only of the articles mentioned, but also of many others, notably moulded electrical insulations, and its application in this field has kept pace with the development of the electrical industry. His invention of automatic machines revolutionized the business, and gave Mr. Sylvester and his business associates a great advantage over competitors.

After fifteen years spent in Auburn, New York, in the composition business, in 1890 he took up his residence in Scranton, becoming associated with William Connell, and his son, Charles R. Connell, now president of The Scranton Button Company. This proved an efficient combination of talent. Charles R. Connell's aggressive business ability combined with Mr. Sylvester's inventive and industrial executive ability have firmly established in Scranton the largest manufacturing plant of its kind in the world, one whose product is shipped to the uttermost parts of the earth.

Although Mr. Sylvester had taken out more than twenty patents on material and processes, he had been granted additional patents on improved processes and methods of manipulation. He is constantly seeking to produce a

still more perfect material and lessen the cost of production. He is of a studious turn of mind, with leaning towards scientific and philosophical subjects.

He is a thirty-second degree Mason, a member of Peter Williamson Lodge, No. 323, F. and A. M.; Irem Temple, Nobles of the Mystic Shrine; all bodies of Keystone Consistory, Ancient and Accepted Scottish Rite; a member of the Temple Club, the Scranton Press Club and the American Society for Judicial Settlement of International Disputes. Politically he is a Republican.

Mr. Sylvester married, in 1874, Louise C. Haendle, daughter of Conrad Haendle, of New York City. Mr. and Mrs. Sylvester have three children: Louise E., a graduate of Wellesley College, now Mrs. Paul L. Criblet, of San Francisco, California; Elfreida, salutatorian of Scranton High School, class of 1899; Louis G., graduate of Cornell University, now assistant manager of The Scranton Button Company; married Harriet Lindsay, daughter of Robert K. Lindsay. Mrs. Sylvester and her daughter Elfreida are members of the Second Presbyterian Church. The family home is at 306 Webster avenue.

---

#### WILLIAM J. DAVIS

When the Bliss-Davis Building, at the corner of Adams avenue and Spruce street, was thrown open to the public, it was as the business home of one of its owners, William J. Davis, merchant tailor. Mr. Davis was one of the early merchants and leading citizens of Forest City, Pennsylvania, until 1896, when he located in Scranton and here has advanced to the front rank in his private business and to important position in the various corporations in which he is interested. He was born in county Donegal, Ireland, October 30, 1856, son of Robert and Mary (Brown) Davis, both descendants of old families of that county and freeholders for many generations. His father, Robert Davis, came to the United States with his family of six children in 1864, and purchased a farm on Long Island, New York, where he engaged in agriculture until his death. The old homestead still remains in the possession of the family. He had seven children who grew to mature years, William J., of whom further; Margaret; Sarah; John; Robert; George; Minnie.

William J. Davis passed the first seven years of his life in his native land, was brought to the United States with his parents in 1864 and grew to manhood at the Long Island farm. He was educated in the public schools of his neighborhood, later continuing his studies at schools in Maine, and St. Albans, Vermont. After his marriage he purchased a farm in Wayne county, Pennsylvania, teaching school during the winter months and managing the farm in the summer. In 1884 he sold his farm and began mercantile life in Forest City, then little more than a name, he being one of the first merchants there. For thirteen years he engaged in mercantile tailoring, and as dealer in ready-made clothing and all branches of gentleman's furnishings. He prospered abundantly and was one of the leaders in the development of Forest City from hamlet to borough. He held many public positions, but was especially interested in educational matters. He was a member of the school board and its president when the present admirable system of schools was inaugurated and buildings erected for their accommodation. So carefully were they planned and so business-like was their erection that their comparatively small cost caused public comment. Mr. Davis also erected the finest opera house in the county, one unequalled anywhere in the country in towns even much larger. He also erected many other buildings; was a member of the building committee that erected the Episcopal church, contributed the first money for the



building of the Methodist Episcopal church and was one of the first subscribers toward the building fund of the Roman Catholic church. In 1896 he located in Scranton, opening a merchant tailoring establishment in the old Frothingham Arcade. Later he located on Spruce street, remaining there three years, then moving to the newly completed Bliss-Davis Building, corner Adams avenue and Spruce street, of which he is part owner. He does a very large merchant tailoring business, greater in volume than any other tailor in the city. He was one of the organizers of the Union National Bank, which he serves as director, and was president of the Scranton Fire Insurance Company until it passed out of existence. He is a member of Saint Luke's Episcopal Church and in political faith is a Republican. Mr. Davis has acquired considerable valuable real estate in Scranton and other towns and in connection with Mr. Valentine Bliss he is developing a section of land consisting of forty acres in the eastern part of the city.

Mr. Davis, married Frances, daughter of William B. Dalton, of county Clare, Ireland, the Daltons were originally a family of France. Children: 1. William R., a graduate of Friends School, Providence, Rhode Island, and of Massachusetts Institute of Technology, degree of C.E., now engaged in his profession in Pittsburgh. He was one of the engineers engaged in the construction of Pittsburgh's filtration plant. 2. Ralph, graduate of Blair (Pennsylvania) High School and of Cornell University, class of 1911, C. E., now engaged with the great steel firm of Pittsburgh, Jones and Laughlin. 3. Harold, graduate of Blair High School, received an appointment as cadet to the United States Naval Academy at Annapolis, spent one year there; entered the School of Mines at Golden, Colorado, now engaged in the real estate business in Scranton. 4. Dalton, graduate of Blair High School, spent one year at Dartmouth College, then entered Columbia University, whence he was graduated 1913 in pharmacy.

---

#### JENNIE LEWIS EVANS

That one of the leading retail business houses of Scranton is presided over by a woman is rather unusual even in this day of advanced thought concerning the equality of the sexes. But when the training previously secured while in the employ of others, her natural aptitude and her acute business instinct is weighed, it causes no wonder that Mrs. Evans has risen to a high position in the mercantile world. In fact the qualities she possesses invariably lead in but one direction, upward. Thoroughly a business woman and asking no favors from her masculine competitors on account of sex, Mrs. Evans is so essentially feminine, gentle and modest, that her success in the stern world of competitive business calls for more than passing comment. This rare business ability does not come to her as an inheritance from commercial ancestors, as their lot was cast among the mountains of Wales where extracting minerals from mother earth to enrich others, rather than themselves, was their portion. So as neither heredity nor environment can be charged with her rise in the business world, the secret must be in her own character. While from her Welsh forbears strength of body, clearness of mind and habits of industry were obtained, the motive power that drives these powers into her service is not difficult to find. Starting humbly as a clerk, an ambition was aroused to become a merchant herself. With this definite ambition, close observation, untiring energy and thorough study of the principles underlying retail merchandising, soon brought her to the starting point of an independent mercantile career. The experience ripened her judgment, fewer and fewer mistakes were made, success followed success as lines were broadened and trade

increased until from the little beginning with two employes, she now is proprietor of the largest as well as the second oldest retail shoe store in Scranton, employing twenty-five people, enjoying a high class of patronage, sufficient to keep them all busy. That this has been accomplished in the years since 1888 seems additional reason to confer upon Mrs. Evans the title of "Scranton's leading business woman."

Mrs. Jennie Lewis Evans was born in Carmarthenshire, Wales, daughter of Reese J. and Ann (Jones) Lewis. Her father, Reese J. Lewis, was a miner and contractor in his native land, coming to the United States in 1868. He spent the remaining years of his active life in mining operations, prospered and spent his last years retired. He died in 1887. (For a more extended account, see sketch of William R. Lewis in this work).

Jennie Lewis was brought by her parents to Scranton in 1868 and here she obtained a good education in the public schools. Determining upon a business career she entered the employ of Goldsmith Brothers, continuing until 1888, when in partnership with David M. Reilly, she established a retail shoe store at No. 114 Wyoming avenue, under the firm name, Lewis & Reilly. The business grew, and prosperity came as a result of well directed effort and the best modern methods. The firm established a high standing in the business world for energy and integrity, and existed in the same locality and under the same ownership until 1900, when Mr. Reilly withdrew. The store is still continued at the same location under the direct management of Mrs. Evans, its founder, but greatly enlarged and improved.

Jennie Lewis married, in 1909, Elias E. Evans, born in Wales in 1862, son of Daniel D. Evans, who soon afterward came with his family to the United States, locating at Hyde Park (Scranton) where he organized the firm of D. D. Evans & Company, which became one of the prosperous business houses of that section. Elias E. Evans, after completing his studies, entered mercantile life, and is now proprietor of the oldest shoe store in Hyde Park, and a successful and prosperous merchant, senior partner of the firm of Evans & Powell. He is active in religious and public life of Hyde Park, served twelve years as school director and is a deacon of Plymouth Congregational Church. Mrs. Evans is also a communicant of that church.

---

#### GARRETT SMITH

Garrett Smith, a prominent and influential resident of Scranton, Pennsylvania, traces his ancestry through a long line of English forbears. He was born near Belvidere, Warren county, New Jersey, September 17, 1830, son of Jacob and Caroline (Axford) Smith.

Captain John Axford, maternal great-grandfather of Garrett Smith, was born in England, December 22, 1761, died January 14, 1843. He came to this country previous to the Revolutionary War, in which he actively participated, receiving his commission as captain under General Washington. During the struggle he made his home at Oxford Furnace, New Jersey, where he became possessor of a large tract of land and where he made his home upon the cessation of hostilities. He subsequently became a drover, an occupation he followed for many years, as it was an agreeable and lucrative means of livelihood. He bore a reputation upon which there was no suggestion of a smirch, his dealings with his fellow men being honorable and upright, while his private life was scrupulously clean. In religious faith he was a Presbyterian, and in politics a staunch Whig. He married Eleanor P. Polhemus, born in the colonies, April 7, 1767, died June 22, 1848, aged eighty-one years, daughter of John Polhemus, of English birth, and granddaughter of John Hart, one of the





*Garrett Smith*

signers of the Declaration of Independence. Children: Abraham, John, Charles, Montgomery, Eleanor.

John Axford, maternal grandfather of Garrett Smith, was a native of New Jersey, a farmer by occupation, and in 1829 moved from his native state to southern Michigan, locating in Oakland county, a section of the state then a wilderness. He purchased 640 acres in the oak openings and erected a log house in the middle of the section. As a farmer he was practical and efficient, qualities which he also possessed in business dealings, together with a keen sagacity. He married (first) Mary De Que, of French extraction, (second) Charity Axford. Children of first marriage: Samuel T., John, Abraham, Caroline, Mary, Sarah. Child of second marriage: William J.

(I) Peter Smith, paternal grandfather of Garrett Smith, a native of New Jersey, followed his occupation of farmer in Warren county, near Oxford Furnace, where he was the owner of 260 acres of good farm land. Upon his death the property came into possession of his sons, later becoming the property of Garrett Smith, who still retains it, with the exception of a few lots platted for the village of Oxford Furnace, which was named by Captain John Axford for Oxford, England. Peter Smith died at his home in Belvidere, New Jersey, aged eighty years.

(II) Jacob Smith, father of Garrett Smith, was born in Warren county, New Jersey. For a number of years he engaged in farming in the vicinity of Belvidere, later moving to near Oxford Furnace. In 1855 he located in Michigan and purchased a farm near Rochester, Oakland county, where he spent the remainder of his life. He married Caroline Axford, born in New Jersey in 1810, died in 1848. Among their children were: 1. Sarah, married William Petty, now deceased, of Washington, New Jersey. 2. Garrett, of further mention. 3. John A., a resident of Oakland county, Michigan. 4. Samuel T., a resident of Rockaway, New Jersey, who served as private in a Pennsylvania regiment in the Union army. 5. Peter J., a resident of Rochelle Park, now Passaic, New Jersey, a lieutenant in a New Jersey regiment during the Civil War. 6. Eliza. 7. Caroline, who married John Kline.

(III) Garrett Smith, son of Jacob and Caroline (Axford) Smith, was born near Oxford Furnace, Warren county, New Jersey, September 17, 1830, and now (1914) in his eighty-fourth year is an honored resident of Scranton, Pennsylvania. He obtained his education in the public schools of his native township, and early in life learned the miller's trade. He came to Scranton at an early date, 1848, and is one of the remaining residents of this city who remember the little settlement as Slocum Hollow, then only a furnace and rolling mill. He came here in company with John Landis, making the journey from New Jersey by wagon and teams. Mr. Smith, then only a boy, drove six cows and it took four days to complete the journey. The present city was then little more than a hamlet, giving little promise of the prosperous Scranton of to-day. Mr. Smith's fund of experience in the new section is most interesting and includes the fact that he has hunted rabbits over the ground now occupied by the Lackawanna county court house. For eight months he worked on a farm rented by Mr. Landis and owned by the Lackawanna Iron and Coal Company, on which the Delaware, Lackawanna & Western Railroad station and shops are now located. In the fall of 1849 he was employed in the old frame Slocum mill, operated by the Lackawanna Iron and Coal Company. In 1850 a new mill, the Brick mill, was erected by the same company, that began grinding the same year, with Mr. Smith as foreman or head miller. This mill turned out 600 barrels of flour per month. For thirty years this mill was run by water power, steam then being introduced, obtained from the

company's rolling mills. For fifty-three years Mr. Smith held his position; the mill was abandoned in 1901, and he then retired from active labor, a most wonderful and praiseworthy record of loyalty and appreciation. On April 1, 1860, Mr. Smith removed to his present house, then a farm house located upon a farm owned by the Delaware, Lackawanna & Western Railroad Company, consisting of 300 acres and known as the Griffin farm tract. The house in which he still resides was built in 1812, and for many years he not only acted as the chief miller for the company by which he was employed but also had the supervision of this entire farm, looking after these two interests at the same time. This entire tract of land has since been sold for building lots and it is now thickly covered with residences.

Mr. Smith is a Presbyterian in religious faith and for thirty years has been a member of the board of trustees of the Washburn Street Presbyterian Church, most of that time serving as president of the board. His political affiliations have always been strongly Republican. To few men has so long a term of active life been vouchsafed as to Mr. Smith. His long and useful life is a record of duty well performed, and now long past the allotted term of man's life he takes a keen delight in the doings of the present, although for him the "long ago" is filled with the most pleasant reminiscence. A companionable, sprightly old gentleman he boasts a host of warm appreciative friends to whom he is both an inspiration and a delight. He is an authority on local history, his residence covering the long gap between Slocum Hollow of 1840 and Scranton, the prosperous, thickly populated capital of Lackawanna county of to-day.

Mr. Smith married Mary H. Landis, who died in Scranton, October 9, 1891, daughter of John Landis, with whom he came from New Jersey to Scranton. Children: Samuel Irving, a farmer of Lackawanna township; Lizzie Bell, widow of Frank Freeman, lives with her father; Marvin Colvin, an employee of the Gas and Water Company.

---

#### LAYTON L. SHOEMAKER

A guest enjoying the genial hospitality of the Hotel Jermyn where his every need had been anticipated and every provision made for his comfort, gives little thought to the master mind behind it all, but regards only the immediate party supplying each need. Chef, cook, waiter, clerk or maid are each lauded in turn, but of Mr. Shoemaker, the managing mind of it all, he knows or sees but little. Yet each detail of each department is well known to him, its head is selected and instructed by him and the burden of the management of the great hotel, that cares each day for a number of people greater than the entire population of many villages, rests entirely upon his shoulders. So the personality of the man who silent and unseen, is so important to the prosperity of the great enterprise, becomes of interest.

Layton L. Shoemaker was born in Cherry Valley, Pennsylvania, October 23, 1872. He is the son of Theodore Shoemaker, born in Cherry Valley in 1821, son of German parents, died 1888, his death caused by accident. He was a farmer of the valley for several years, later moving to East Stroudsburg, Pennsylvania, where he entered the bridge building department of the Delaware, Lackawanna & Western Railroad as carpenter, continuing until an unlucky fall from a bridge on which he was employed caused his death.

Layton L. Shoemaker spent his very early life in Stroudsburg, coming to Scranton at the age of ten years, there passing through the public school, finishing in high school, although not completing the full course, having early in life the problem of making his own way in the world thrust upon him. He





*E. D. Antonio.*



began his business career as errand boy in the employ of C. S. Woolworth, continuing six years, but in higher position. He then entered the employ of The Grand Union Tea Company, at No. 109 Wyoming avenue, as clerk, remaining five years, then was transferred to the Lackawanna avenue store of the same city, holding the same position there for three years. In 1894 he became a clerk for F. S. Godfrey, proprietor of the Lackawanna Valley House, Scranton, and there gained his first experience in the hotel business. He remained with Mr. Godfrey two years, then became manager of the cigar business of the Hotel Jermyn. The following year he was appointed cashier of the hotel, two years later became head clerk, and on January 1, 1912, was appointed manager of the hotel, which position he most capably fills. His management of this greatest of Scranton hotels has met with the entire approval of the owners, while the patrons of the hotel are loudest in its praise. The knowledge of duty well performed brings its own satisfaction and reward; the consciousness that one's efforts are noted and appreciated is a source of gratification to any man, and to none does greater credit belong than to Mr. Shoemaker, who has fairly won his way from the bottom of the ladder. He is progressive, energetic and practical, rides no hobbies, but with well formed plans, directs this great house of entertainment, with strict regard for the interest of the owners and the just rights of the traveling public. He realizes that these never conflict but are so closely allied that should either be neglected, both must suffer. He is a member of the Peter Williamson Lodge, Free and Accepted Masons, and of Keystone Consistory, Ancient Accepted Scottish Rite, thirty-second degree, also a "Shriner" of Irem Temple, Wilkes-Barre. In his personality genial and generous, the number of his friends is legion and all have for him a sincere regard.

---

#### EMILIO DEANTONIO, M. D.

Of gentle blood, high university attainments and of political importance in the city of his birth, Dr. Deantonio voluntarily relinquished position and friends to become a resident of the United States. His father, Francesco Deantonio, was a distinguished scholar, physician, naturalist, for several years professor of natural science at the Lyceum of Alexandria and translator of the famous Tito Lucretio Caro poem "De Rerum Natura." This great work was presented in manuscript form to the municipality of Alexandria, North Italy, after the translator's death, by his widow. So highly was the gift prized that that municipality defrayed all cost of publication and gave it to the world in book form. Professor Deantonio married Angiolina Rossi, of Turin, Piedmont (North Italy), and had six children: 1. Emilio, of further mention. 2. Felix, prepared for the practice of law under the famed Italian jurist, Vincenzo Demaria, co-worker in the promulgation of the New Italian Penal Code; Felix Deantonio is a leading criminal lawyer of Turin, Italy; he married the then only living descendant of the renowned Italian astronomer and mathematician, Giovanni Plana; she died in Turin in 1913, leaving large estates in Stradella, Piedmont. 3. Carlo, one of the bravest and most skillful military tacticians of the Italian army in which he holds the rank of lieutenant-colonel; resides in Milan, Italy; he was for many years professor of the Italian School of War, has won recognition from both his own and other governments by whom he has been decorated with many badges of honor; he married Baroness Bichi, of one of Italy's noble families. 4. Attilio, now and for many years professor of literature in the high school of Casale Monferrat. 5. Louise, married Fortunato Tiscar, Chevalier of the Crown of Italy, the well known Italian consular agent of Scranton. 6. Josephine, married Julius Fassella,

professor of physics and mathematics of Milan Normal School, son of the late director of the Italian Naval School at Genoa.

Dr. Emilio Deantonio was born at Alexandria, Northern Italy, October 4, 1870. He was educated in the preliminary school of Alexandria, the Royal University of Turin and Pavia University, receiving from the latter institution at his graduation in 1894 the degree of M.D. He was for one year assistant to the present deputy, R. Rampoldi, who is professor of ophthalmology at Pavia University. Dr. Deantonio, soon after taking his degree, entered the arena of public life and was elected a member of the council, governing the city of Alexandria. Later he was elected to select council, so well had he served the interests of the municipality. During his tenure of office as a councilman, he visited the United States in 1903, arriving on the steamer "Lombardia." He traveled over the country with an observant eye and becoming convinced of the wisdom of such a step resigned his official position in Alexandria, gave up his practice and has ever since been a resident of Scranton. He established an office at No. 346 Franklin avenue for the practice of medicine and has found a most satisfactory demand for his professional services. Thoroughly qualified in his profession, mastering several languages, an educated gentleman and a man of refined tastes and habits, Dr. Deantonio has many friends, who esteem him not alone for his skill as a physician, but as a highly regarded friend. He is one of the directors of the Scranton Private Hospital; fellow of the American Medical Association, and a Progressive in politics.

---

#### WALTER LIVINGSTON LAWRENCE

The ancestry of the Lawrence family is to be sought in that part of Continental Europe that was the home of the Knickerbockers. The records of the Old Dutch Church at New York give the arrival and marriage of the emigrant ancestor and the baptism of his children, from which it would appear that the surname of Lawrence in a less Anglicized form was adopted by the emigrant, because he was the son of a man whose Christian name was Laurens, and that Poppinga was the actual surname of the family, if it had any, in Holland. In the list "Nieuwe Ledematen Aengekomen" is: "Anno 1662 den 2 Jul. Thomas Laurenszen Poppinga;" and in the margin is: "Jun. 9 1663 Thomas Laurenszen j. m. (bachelor) Van Groëningen en Marritje Jans wede. (widow) Van Cornelis Langevelt." A preceding entry is: "den 19 Jaanuar. 1658 Cornelis Van Langevelt Van St. Laurens in Vlaenderen en Marytje Jans, Van N. Amsterdam." There are the following baptisms: Aeltje, Laurens, Thomas, Samuel, Rachel, all children of Thomas Laurenszen and Marritje Jans, born between the dates March 26, 1664, and November 19, 1681. The eldest son of Thomas and Marritje Laurenszen was the father of Thomas, a councillor of the province of Pennsylvania. The same records give his marriage: "1687, den 15 April ingeschreven, Laurens Thomaszen, j. m. Van N. York en Catharina Lievens j. d. als boven, beyde woonende alhier, getrouwt den 11 May." In a MS. which was among Chief Justice Tilghman's papers are the following entries preceding the entries in the handwriting of Thomas, the councillor: "10 May 1687 L: Thomas mary'd Catherin Lewis, he aged 20 years and 10 months and she 17 years and 9 months. Sep. 4 1689 Was born Thomas, Christened the 8th. 20 Oct. 1692 Was born Mary, Christened the 23d. 8 June Was born Rachell, Christened ye 14th. 21st Jan. 1698 Was born Samuel, Christened ye 22nd. 12th May 1699 Was born Cornelis, Christened ye 16th. 9th 1st 1700 Was born Lawrens, Christened ye 10th. 15 Sep. 1702 Dyed Catherin wife of Lawrence Thomas."

Lawrens Lawrence (mentioned previously) married, in Jamaica, Susanna,

daughter of John Lawrence, or Lawrance, of that island, and was the ancestor of J. H. Lawrence-Archer, compiler of "Monumental Inscriptions in the British West Indies."

Thomas Lawrence, as the aforementioned record shows, was born September 4, 1689, and the record of his baptism in the Old Dutch Church at New York is: "1689 den 8 Sept. (Ouders) Laurens Thomaszen, Catharina Lievens, (Kinders) Thomas. (Getuygen) Thomas Laurenszen Poppinga, Geesje Barens." He appears to have settled in Philadelphia about the beginning of 1720, his son Thomas being born there on April 16th of that year, William Assheton, the admiralty judge, and Thomas Sober standing as god-fathers, while Catherine was the godmother at the christening, on the 24th of that month. He entered about this time into mercantile life, being subsequently mentioned by Logan as associated with him in shipping, and in 1730 he became the partner of Edward Shippen, who afterward moved to Lancaster, the firm being Shippen & Lawrence. He continued a merchant until his death, residing on Water street, and owning considerable land near the city as well as farms in New Jersey. Christopher Gadsden, one of the men who attained prominence in colonial affairs and a signer of the Declaration of Independence, spent his early years in the countinghouse of Thomas Lawrence. Thomas Lawrence's family attended Christ Church, and in 1722 he was its junior warden, being in 1749 one of the committee appointed to draft its charter. He was elected a common councilman of Philadelphia, October 3, 1722; alderman, October 6, 1724; mayor in 1727-28-34-49-53, holding the latter honorable office at his death. He was invited to a seat in the Provincial council by Lieutenant-Governor Gordon, April 20, 1727, but did not qualify until May 10, 1728. In January, 1730-37, he was despatched by the council to Lancaster county in company with Ralph Assheton to take measures for the expulsion of a party of Marylanders who were endeavoring to dispossess the settlers on the Susquehanna river, and returned, after an absence of two weeks, reporting the organization of a posse comitatus. In September, 1745, Mr. Lawrence was deputed one of the commissioners from Pennsylvania to treat with the Six Indian Nations at Albany. On January 1, 1747-48, Benjamin Franklin, declining the rank of lieutenant-colonel of the Associated Regiment of Foot for Philadelphia, "recommended Mr. Lawrence, a fine person and a man of influence," says the Autobiography, "who was accordingly appointed." Among his many and varied activities Thomas Lawrence was for some time the presiding judge of the county of Philadelphia, a subscriber to the Dancing Assembly, and a trustee of the College.

His marriage is thus recorded by himself: "Ye 25th of May 1719 I, Thomas Lawrence was maryed to Rachell Longfield at Raritan by Parson Vaughn. Present our parents. I convened John Spratt, Thomas Clark and Richard Ashfield." She was born in 1689, died at Philadelphia, and is buried in Christ Church yard, daughter of Cornelius Longfield, of New Brunswick, East Jersey, who was probably the "Cornelis Langevelt" who was a son by the first marriage of Thomas Lawrence's grandmother. Cornelius Longfield had two other children, Henry and Catherine, who married John Cox, and was mother of John Cox, of Bloomsburg, New Jersey, and grandmother of the wife of Hon. Horace Binney and the wife of John Redman Coxe, M. D., of Philadelphia.

Thomas Lawrence died April 20, 1754, and was buried in the family vault in Christ Church yard, the following obituary notice appearing in the Pennsylvania Gazette: "Last Sunday, after a tedious Fit of Sickness, died here, very much lamented, Thomas Lawrence, Esq. He had the Honour to be a Member of the Council of this Province, was President of the Court of

Common Pleas for the County of Philadelphia, had been five Times elected Mayor of this City, and in the enjoyment of these Offices ended his life. Characters are extremely delicate, and few or none drawn with Exactness and at Length, are free of Blemish. Of this Gentleman we think it may be truly said, he was an affectionate Husband, a tender Parent, a kind indulgent Master, and a faithful Friend. The Funeral was respectfully attended on Tuesday Evening by a great number of the principal Inhabitants of the Place, who justly regret the Death of so able and diligent a Magistrate as a public Loss." Children of Thomas and Rachell (Longfield) Lawrence: 1. Thomas, of whom further. 2. Henry, born August 10, 1721, died in infancy. 3. John, born November 20, 1722, died in infancy. 4. John Spratt, born May 30, 1724, educated at Oxford, England, became a prominent attorney of Philadelphia, was a member of the council, an alderman, mayor of the city from 1765 to 1767, and was a judge of the Supreme Court; he married, April 19, 1750, Elizabeth, daughter of Tench Francis, attorney-general of Pennsylvania, and Elizabeth (Turbutt) Francis, and died January 20, 1799. 5. Mary, born November 30, 1725, died in 1799; she married, August 31, 1754, William Masters, of Philadelphia, son of Thomas Masters, who in 1708 was mayor of the city and was for three years a member of the Provincial council. 6. Longfield, born January 27, 1727, died in infancy. 7. Catherine, born November 5, 1728, died January 13, 1729. 8. Longfield, born May 19, 1731, died in infancy.

Thomas (2) Lawrence, eldest child of Thomas (1) and Rachell (Longfield) Lawrence, was born April 16, 1720, was baptized at Christ's Church, April 24, 1720, died in Philadelphia, January 21, 1775, and is buried in Christ Church yard. Upon becoming of age he engaged in business in partnership with Peter Bard, opening a store on Water street, opposite that of his father, and prospering. He then became a conspicuous figure in the public life of the day, was chosen a common councilman of the city, October 4, 1748, was vendue master from 1752 to 1765, became an alderman in 1755, and mayor in 1758 and 1764. His country-seat, one hundred and fifty acres in the Northern Liberties of Philadelphia, was called Clairmont. He married, at Morrisania, New York, May 9, 1743, Mary, born November 1, 1724, died in New York, in 1808, and is buried in the North Church yard at Hamburg, New Jersey, daughter of the Hon. Lewis Morris, of Morrisania, judge of the vice-admiralty for New York and New Jersey, and his first wife, Trintie or Catherine (Staats) Morris. Children of Thomas (2) and Mary (Morris) Lawrence: 1. Katherine, born February 5, 1744, died May 24, 1784; married, in 1765, John Shee, prominent in the public service of Philadelphia and a soldier in the Revolution. 2. Thomas, of whom further. 3. Rachel, born October 30, 1747, died in February, 1783; married John Marston. 4. Lewis Morris, died in infancy. 5. John, born September 15, 1751, died about 1799; married Elizabeth St. Clair, whose father was General Arthur St. Clair, of Revolutionary fame. 6. Staats, died in infancy. 7. Robert Hunter, died in infancy. 8. William, born September 22, 1755, died 1795; married Jane Tongalou Ricketts, of Elizabethtown, New Jersey. 9. Morris, died young. 10. Staats, lost at sea. 11. Richard Morris, died young. 12. Mary, born November 5, 1765, died before 1796; married Warren DeLancey.

Thomas (3) Lawrence, second child and eldest son of Thomas (2) and Mary (Morris) Lawrence, was born October 6, 1745, was baptized at Christ Church, and died in Hamburg, New Jersey, November 18, 1823. He engaged in business in New York City and was afterward a merchant in New Jersey, becoming a judge of the court of common pleas of Sussex county. He married (first) Rebecca, daughter of Dr. Thomas Bond, the founder of

the Pennsylvania Hospital, who resided at Kenderton, in Philadelphia county, Pennsylvania. She died November 28, 1771. He married (second) his cousin Mary, daughter of Lewis Morris, of Morrisania, a signer of the Declaration of Independence. She died at New York in July, 1776. He married (third) his cousin, Catherine Morris, a sister of his second wife. Children of first marriage of Thomas Lawrence: 1. Mary, born October 16, 1769; married, in December, 1789, Gabriel Ludlum, a judge of Orange county, New York. 2. Sarah Rebecca, born June 1, 1771, died at Hamilton, Madison county, New York, July 1, 1850; married Warren De Lancey, a soldier of the Revolutionary war. Child of second marriage of Thomas Lawrence: 3. Thomas John, born July 4, 1776; was an ensign in the First Regiment United States Infantry in 1799, in which year he died at Baltimore. Children of third marriage of Thomas Lawrence: 4. Lewis Morris, born 1779, died in early youth. 5. Maria, born 1780, died 1870; married, 1810, Walter Lewis Shee, her cousin. 6. Richard Morris, born 1781, died unmarried in 1858. 7. Catherine Jane Turnbull, born 1782, died unmarried in 1862. 8. Jacob, born 1784, died in boyhood. 9. William, born 1785, died in early youth. 10. Lena, born 1787, died in girlhood. 11. Thomas Johnson, of whom further. 12. Sarah Morris, born 1793, died in November, 1814; married, in 1813, Dr. Jesse Arnell.

Thomas Johnson Lawrence, son of Thomas (3) and his third wife, Catherine (Morris) Lawrence, was born in 1789, died December 7, 1851. His home was at Morrisvale, Sussex county, New Jersey, although his business kept him much of the time on the road. He married, at Christ Church, December 1, 1813, Janet Willson, who died December 17, 1821. Children: 1. Thomas, of whom further. 2. Catherine Morris, born November 1, 1816, died unmarried at Oaklands, November 24, 1875. 3. Euphemia Ogden, born May 20, 1818, died 1820. 4. Julia Ludlum, born May 20, 1818. 5. Sabina Rutherford, born 1819, died young.

Thomas Lawrence, eldest son and child of Thomas Johnson and Janet (Willson) Lawrence, was born in Hamburg, New Jersey, December 30, 1814, died in 1893. His education was obtained principally in the public schools of his native town, and at the completion of his studies he engaged in the milling business at Lafayette, New Jersey. He then went to Sparta, New Jersey, and there for a time engaged in the foundry business, leaving this occupation to return to the home farm at Hamburg. Here he remained until his death, taking an active part in the public life of the state. From 1879 to 1891 he was a member of the state senate and in addition to this important service he was for twenty-five years interested in educational work throughout the state as a member of the State Board of Education. He was also the representative of his county upon the State Geological Board until his death. Through his wisely directed and willing efforts New Jersey was made the beneficiary of the talents that have been possessed in such great abundance by the members of the Lawrence family, all the previous generations of the name having offered their allegiance to Pennsylvania, the pages of whose history they brightened to a marked degree by the fidelity of their service. He married Margaret, daughter of Hugh and Martha (Linn) Taylor, of Sparta, New Jersey. Children of Thomas and Margaret Lawrence: Martha Morris, Thomas, Hugh Taylor, Janet Willson, Robert Linn, Staats Morris, Margaret Rembert, Walter Livingston, of whom further; Gabriel Ludlum, Catherine, Maria Morris.

Walter Livingston Lawrence, son of Thomas and Margaret (Taylor) Lawrence, was born in Hamburg, Sussex county, New Jersey, March 10, 1857. He attended the public schools of his birthplace and later matriculated at Rutgers College, whence he was graduated B. S. in 1878. His first employ-

ment was with the United States government as a member of the census-taking force engaged in compiling the tenth federal census of 1880, his first business experience being obtained with the Burden Iron Company, of New York, as mining engineer. He was the chief promoter of the Hudson River Ore and Iron Company, organized at Hudson, New York, and until 1886 was assistant general manager of this company's interests, in that year opening an office in New York City, where he conducted business as a mining engineer for a short time. In October of the same year he accepted a position in the real estate office of the Delaware & Hudson Company as chief clerk and engineer, and in 1904 succeeded to the position of head of the department, a vacancy caused by the retirement of C. S. Weston, the former incumbent. He still serves the Delaware & Hudson in this capacity and manages with wise and far-seeing judgment the various real estate operations of that company. His length of service in that employ is an eloquent testimonial to the general satisfaction with which his work has been regarded, and with the benefit of twenty years experience he is at the present time better fitted to fulfill the duties of his office than at any other time in his career. He is a member of the American Institute of Mining Engineers, and in political issues supports Republican principles. His church is the Protestant Episcopal, and he is a member of the Church of the Good Shepherd, Green Ridge, being a vestryman and secretary from 1887 to 1903.

Mr. Lawrence married Laura Lovell Brown, daughter of John Hancock and Lucy (Lovell) Brown. Children: Jeannette Wilson, born 1884; Lovell, born 1887; Morris, born 1897.

---

#### PETER WILLIAM HAAS

From Germany came Daniel Haas, father of Peter W. Haas, the recorder of deeds of Lackawanna county, descendant of an old and honorable German family. He was a man of forty years of age when he arrived in Scranton, where he was first employed in the mines, later as a worker in the employ of the Lackawanna Iron & Steel Company of this city. In the discharge of his duty he received injuries that caused his death in 1893. His wife, Amelia (Benke) Haas, who survives him, is also of German parentage. Children: Fred P., of New Jersey, connected with the Richardson and Boynton Company; Peter W., of whom further; Minnie, a clerk in the International Correspondence Schools; Harriet, married Edward Reese; Mary, married Herman Bonnert; Annie, married Adolph Hoffmeister; Harry, residing in Detroit; Jeannette, a clerk, residing in Scranton with her widowed mother and her sister Minnie.

Peter William Haas, second son of Daniel and Amelia (Benke) Haas, was born in Scranton, Pennsylvania, January 3, 1877. He obtained a good education in the public schools, supplemented by a course at the Scranton Business College. He began his career as a breaker boy, graduating from that to a position as clerk in a clothing store. This was followed by a term of service with the Scranton Tribune-Republican, later with the International Text Book Company, after which he became proprietor of a hotel on the South Side. In 1911 he was appointed clerk in the county commissioner's office, and in 1913 was nominated by the Republican county convention for the office of recorder of deeds, and at the following election, November 4, was elected by a large majority. He assumed the duties of that office on January 1, 1914. This is not Mr. Haas' introduction to official life. He served in the common council from the nineteenth ward for two years, was select councilman from the eleventh ward, and was chairman of the old council that was a victim of the "Ripper"



*Peter H. Haas*





bill that was enacted by the Pennsylvania legislature. In all capacities he has proved efficient, and has won the confidence of his fellow-citizens to a high degree. That he measures up to the same lofty standard as recorder of deeds is a foregone conclusion. He is a member of the Masonic Order, the Patriotic Order Sons of America, the Fraternal Order of Eagles, the Scranton Athletic Club, and the German Presbyterian Church.

He married, in October, 1897, Minnie, daughter of John Hahn, of Scranton. Children: Clarence, Robert, Peter William (2), Edna. The family residence is at No. 415 Pittston avenue.

---

#### ERASMUS DENTON AMES

The history of the Ames family carries back to early Colonial days in New England, the settlement in Pennsylvania having been made by a descendant of the emigrant, Joseph (2) Ames, a Connecticut farmer, grandfather of Erasmus D. Ames, present cashier of the Lackawanna and Wyoming Valley Railroad ("Laurel Line"). On leaving his Connecticut farm Joseph Ames settled in Canaan Corners, Pennsylvania. The family is of English origin and Connecticut the first seat of this branch in America.

(I) Joseph Ames was born in Stonington, Connecticut, and there lived his entire life, although he made a long visit with his son Joseph (2). He served in the Revolutionary army and for his services drew a government pension in his later years. He was a farmer by occupation, as were his progenitors. He married, in 1777, Hannah Tyler, and had issue: William, Erastus, Hannah, Elijah, Joseph. William Ames settled at Rockford, Illinois, and during the administration of President Pierce was United States minister to Germany.

(II) Joseph (2) Ames, son of Joseph (1) Ames, was born in Stonington, Connecticut, October 28, 1790, died in Canaan township, Wayne county, Pennsylvania, in August, 1849. He spent his minority on the home farm, then, on a fine horse, his only possession, he rode westward to Wayne county, Pennsylvania, a locality that lured many Connecticut farmers from their native state. For the first three years he taught school in the rude log schoolhouse of the county, married, and settled on 125 acres of wild land he had purchased at Canaan Corners. This he partially cleared and made his home for several years. He then sold this property and purchased 150 acres, 100 of which he lived to clear, cultivate and improve with substantial buildings. He was an ardent Whig politically, and in spite of his modesty and retiring disposition he was frequently called to public offices of trust by his neighbors. He was a member of Wymart Lodge, Free and Accepted Masons, and a man highly regarded for his uprightness of life and his benevolence. He married Gertrude, daughter of Colonel John H. Schenck, of Monmouth county, New Jersey, of Dutch ancestry. Colonel Schenck, born in Monmouth, was a wealthy man and during the Revolution armed and equipped a regiment which he personally commanded until the war was over. Gertrude, his daughter, was born in 1793, in Hunterdon county, New Jersey, and came to Wayne county, Pennsylvania, with her father, who was one of the Wayne county pioneers. Colonel Schenck died at Canaan Corners after a life of political prominence in Wayne county. Children of Joseph and Gertrude Ames: Erasmus D., married Jane Clawson; Nelson, married (first) Nancy Hoadley, (second) Susan Cramer; Eliza, married (first) Alexander Andrews, (second) William Annan; Tyler, died in boyhood; George R., married Catherine McClain; Clarissa, married John Clawson; Henry C., a farmer, cattle dealer, merchant and banker, married (first) Julia Ann Enslin, (second) Sara F. Wheeler; Jacob S., merchant, banker and lumberman, married Harriet N. Woodward;

John H., of whom further; Reuben T., married Helen Thorp; Sarah D., married John Stryker.

(III) John H. Ames, ninth child of Joseph (2) Ames, was born at Canaan Corners, Wayne county, Pennsylvania, in 1833, and now, after a long life of activity as builder, merchant and farmer, is living retired at Hawley, Pennsylvania. He attended the public schools, but early became a worker, being a driver for the Delaware and Hudson Canal Company between Summit and Carbondale when but nine years of age. At fifteen years of age he began learning the carpenter's trade with the Plums of Hawley. When the "Gravity" road was in the course of construction he was placed in charge of the building of engine house No. 15, the first building he ever erected as superintendent. When the road was completed and put in operation he was placed in charge of the water wheel at Hawley. In 1860 he opened a general store in that town, continuing until 1867, when he became a partner with his brothers, Jacob S., and Reuben T., trading as J. S. Ames & Brothers, and dealing in general merchandise, lumber, cattle, hay, grain and feed. The firm was the largest in Wayne county, operated the largest feed mills in the county, and owned thousands of acres of timber land. Their cattle were driven to Newburgh, New York, there ferried across the Hudson, and driven to the abattoir then located at Forty-second street, New York City. In 1884 John H. Ames withdrew from the firm, which continued under the same name until 1886, when the property was divided. In addition to money, John H. Ames received as his share a farm in Minnesota and one of 600 acres at Winding Hill, Wayne county, Pennsylvania, known as the "Ames Homestead," on which he resided until 1903. He then sold the estate to a New York banker and retired to private life at Hawley, his present residence (1914).

Mr. Ames married Melissa, daughter of Amzi L. Woodward, born in 1806, died in 1878, of Paupack township, Wayne county, Pennsylvania, son of John Woodward, of Cherry Ridge township, Wayne county. Amzi L. Woodward married Irene L. Kellam, whose parents were early settlers in the Paupack settlement on the Wallenpaupack, her father, Moses Kellam, born 1792, died in 1862, a justice of the peace at Paupack settlement and for many years county surveyor. Two of Amzi L. Woodward's daughters married Ames brothers, Melissa and Harriet N., the latter the wife of Jacob S. Ames. Children of John H. and Melissa Ames: W. Dewight, William C., Densmore, Homer G., Erasmus Denton. Of the eleven children of Joseph (2) Ames the only survivor at this time (1914) is John H. Ames, of previous mention, who is now aged eighty-one years.

(IV) Erasmus Denton Ames, youngest son of John H. and Melissa (Woodward) Ames, was born at Hawley, Pennsylvania, October 31, 1874. He was educated in the public schools of Hawley and the Wyoming Commercial College (1894). On completing his school years he became his father's assistant in the cattle buying business, continuing until 1896, when he entered the employ of the Erie and Wyoming Valley Railroad as clerk at Dunmore Station under Victor Burschell. In the fall of 1897 he became connected with the Pennsylvania Coal Company at Dunmore, which connection continued until 1900. In October of the latter year he was appointed secretary to the master mechanic of the Erie Railroad at Dunmore, J. B. Bronson, but a year later resigned that position to become a clerk under A. M. Benghan, chief clerk of the Erie Coal Company. When the great coal strike of 1902 paralyzed the coal industry, Mr. Ames was one of the many clerks laid off. When the strike was over and business was resumed, he entered the employ of the Spencer Coal Company, of Dunmore, in charge of one of the outside gangs of workmen, rigging new shafts, planes, electric lights and pumps. He continued in

this position until May 10, 1903. On May 20 following he was appointed cashier of the Lackawanna and Wyoming Valley Railroad ("Laurel Line"), to which was also added the position of paymaster, also that of treasurer of the Lackawanna and Wyoming Power Company. Mr. Ames is eminently qualified for important places he holds in the business world, and has the perfect confidence of those in authority in the corporations named. He is very popular with the entire force of the "Laurel Line," his genial and generous disposition making him friends everywhere, his manly and upright character holding them to him. He is a member of the Masonic Order, the Independent Order of Odd Fellows, and the Junior Order of United American Mechanics. In political faith he is a Republican.

Mr. Ames married, February 25, 1899, Maud Savage, daughter of Robert P. Savage. Child, Charles, born February 6, 1900.

---

#### OTTO I. EBERHARDT

There are among the mixed peoples and races that comprise the population of the city of Scranton but a few who claim the Scandinavian Peninsula as their birthplace or whose ancestors owned it proudly as their home. One of the few who name it as the land that gave them birth is Otto Immanuel Eberhardt Jr., son of Otto Immanuel Eberhardt Sr. Otto Immanuel Eberhardt Sr. was a lumberman and farmer of Norway, married Laura Johanna, daughter of Doctor Irgens, of Skien, Norway. She is now living in Minnesota. Children of Otto Immanuel (1) and Laura Johanna Eberhardt: Christianna Cornelia, Otto I., of whom further.

Otto Immanuel (2) Eberhardt was born in Skien, a seaport of Norway, capital of the amt of Bratsberg, situated at the mouth of the Skiensfjorden, August 5, 1879. He attended the public schools of his native land and was graduated from the high school in 1897. On August 19 of that year he came to the United States, taking passage on the steamship "Island," a vessel of the Scandinavian-American line, the voyage consuming fourteen days. He landed in New York City and the following year matriculated at the University of Minnesota, whence he was graduated E. E. in 1903. Proficient in all branches requiring electrical skill and knowledge, it was not difficult for him to obtain a position, which he did with the Minneapolis General Electric Company. He left the employ of that firm after one year and entered the service of the Western Electric Company, of New York City, in the capacity of assistant factory engineer. His next position was as electrical engineer for the Crocker Wheeler Company, of New Jersey, later with the Westinghouse Electric and Manufacturing Company at Philadelphia as sales agent. He was engaged at Philadelphia for a period of six months and was afterward transferred to the Hazleton office of the same company, where he remained for three years. At the expiration of that time the office was moved to Wilkes-Barre and he was in that city until 1911. In this year he became one of the organizers of the Penn Electrical Engineering Company, of Scranton, which was incorporated in the following year, when Mr. Eberhardt was made secretary and sales agent. In this position he plays an important part in the direction of the company's affairs and efficiently manages the distribution of its productions. He is a member of the Engineering Society of Northeastern Pennsylvania, the American Institute of Electrical Engineers, the Engineers' Club, of Scranton, the National Geographical Society, the Hazleton Country Club, and the Norwegian Society of Greater New York. His membership in the various engineering societies plainly shows the interest he takes in all that pertains to his chosen profession, and in the fact of his membership in the Norwegian

Society is the key to the love and honor with which he regards his homeland. Nor is it strange that the memory of a son of Norway should hark back to his native country with filial love, for few of the Old World lands can boast of a history so replete with thrilling deeds and conquests, nor was any more glorified in the works of her children. Bold Vikings of the North, sons of Thor, their imprint is left upon their descendants, and their living and dying made the world richer by a mythology unrivalled even by that of the Greeks. Mr. Eberhardt is a Republican in politics, and belongs to the Lutheran Evangelical Church.

---

### JOHN SCHEUER

In the person of John Scheuer, the old German family of the name has an American representative, who has taken a prominent place in Scranton business life and in the politics of both the city and the state. In both of these channels he has proven true worth, in both has held the confidence of his fellow-men, and in both has attained that degree of prominence and station that men call success.

His father, John Schener, was born in Harxheim, Rhein province, Germany, and there learned and following the trade of linen weaver. He was engaged in the rebellion in his native land and in 1848 came to this country with his father, Conrad, landing in New York. They had made Scranton their objective point, and, in order to husband their slender resources, made the trip from New York on foot. They were unable to procure food for a long distance along their route, so that, although they did not actually suffer for lack of nourishment, the experience was not of the pleasantest. Arriving at their goal, they sought and secured employment in the blast furnaces of the Lackawanna Iron and Coal Company, under Joseph H. Scranton. After several years Mr. Scheuer worked for a time with John Jermyn, running ore trucks from the mines and logs to the saw-mill. Not finding these various occupations to his liking. In 1860 he entered the milk business, the first milk dealer in the city and the consignee of the first can of milk shipped over that division of the Delaware, Lackawanna & Western Railroad, the point of shipment being Glenburn. He served a route in the city for six years and then established as the proprietor of a retail grocery store on Willow street. In 1874 he started a bakery at 342 Locust street, in a modest way, with only his two sons, George, who had just completed his apprenticeship, and John, of whom further, as assistants. In 1889 he retired from active business and engaged in farming on a moderate scale as a pastime. His sons succeeded to the management of the business under the name of the Schener Brothers Company. With his wife, John Scheuer was a member of the Hickory Street Presbyterian Church, of which he was an organizer and trustee. He died April 11, 1911. He married Petronella, daughter of Conrad Hoffman, born in Wachenheim, Rhein-Hessen, Germany, died in Scranton, May, 1895, coming to that city when a young woman. Children: George, president of the Pennsylvania Baking Company and of the Scheuer Baking Company; John (2), of whom further; Henry; Philip; Peter; Katherine, married Peter Schillert, deceased, and resides in Scranton.

John Scheuer, son of John and Petronella (Hoffman) Scheuer, was born in Scranton, December 12, 1858. He attended the public schools and his first business experience was obtained in his father's store, but after a year of this employment, he made a thorough study of the baking business. He continued in business with his father, taking several night courses at neighboring business colleges, first at Gardner's and then at Prof. H. D. Walker's, graduating from



*John Scherer Jr.*



the latter in 1889. In that year the business founded by his father was incorporated as Scheuer Brothers, which in 1901 was replaced by the Pennsylvania Baking Company. At the incorporation of the Scheuer Baking Company in 1912, the bread department of the Pennsylvania Baking Company was transferred thereto, the latter company now engaging exclusively in the baking of cakes and crackers. The bakery employs about 125 persons, consumes about forty-five barrels of flour a day, and ships its products throughout northeastern and central Pennsylvania. In addition to this, eight wagons are constantly employed supplying the local needs. The Scheuer Baking Company, of which Mr. Scheuer is secretary and treasurer, the offices he holds in the Pennsylvania Baking Company, engages only in the baking of bread, their daily output of 12,000 loaves, produced by sixty employees, being distributed throughout the valley by eighteen delivery wagons. Mr. Scheuer's only other business connection is as director of the Anthracite Trust Company, although he has helped organize and has been extensively interested in several building and loan associations. He was also one of the organizers of the Scranton Axle Company, performing service in the same capacity for the South Side Board of Trade, being its president for three years. In politics his record as a staunch Republican reflects credit upon the party and has been of benefit to the city and state. In 1886 and 1887 he was a member of Scranton select council from the eleventh ward and was repeatedly a delegate from the city to the Republican state convention. From 1899 to 1902 he was a member of the state legislature, representing his district with distinction and securing the passage of the State Hospital bill, a piece of legislation providing for the state control of the Lackawanna Hospital. He presented this measure at the session of 1901, at the same time requesting an appropriation of \$200,000 for its maintenance and improvement, both of which were acted upon favorably. His support of measures tending toward the benefit of other districts than his own was always enthusiastically given, but he was ever the foe of graft and the direction of public funds into private channels. He is a member of Schiller Lodge, Free and Accepted Masons, and the Royal Arcanum. With his wife, he is a member of the Hickory Street Presbyterian Church. Mrs. Scheuer is active in the various departments of church service as in the work of the Young Women's Christian Association.

Mr. Scheuer married Anna M., daughter of William Linn, of Scranton. Children: William W., associated with his father in the bakery business; Anna C., married Dr. George Huber, a physician of Coffeyville, Kansas; Dorothy S.; John C.; Ruth L.; Bernice S. Mr. Scheuer's position among his business associates is one of honor and respect, the former for the high moral character and unswerving integrity that have marked his every relation, public, business, or private; the latter for the ability he has displayed in political and financial dealings.

---

#### ERASTUS SCRANTON DOUD

Like many other names early brought to America, this surname is found as Dow, Douw, Dowe, Dowed, Dowde, Doude, Dowd, Doud and Dodd, it, in common with others, suffering from the differences of opinion and custom in its different branches. The name of the emigrant ancestor, as signed by himself on the papers signed by all the planters before landing from the ship at Guilford, Connecticut, was Henry Doude. Some of his descendants have retained that form, others have dropped the terminal "e." Henry Doude, it is believed, is the progenitor of all the Douds or Dowds who were in this country prior to 1776. He came from Surrey or Kent county, England, with a com-

pany under Rev. Henry Whitfield, and settled in Guilford, Connecticut. He died in 1668, thirty years after landing. His wife, Elizabeth, died in 1713. They were probably married in England, and were the parents of four sons and four daughters.

(II) Thomas Doud, the eldest son, is supposed to have been born in England, as no record of his birth has been found in Guilford. He settled in East Guilford, now Madison. He married Ruth Johnson and both died in 1713, having four sons and one daughter.

(III) Thomas (2) Doud, son of Thomas (1) Doud, was born in 1684, died in 1711, a resident of East Guilford. He married Silence Evarts, and had two sons and a daughter, Silence.

(IV) Ebenezer Doud, the eldest son of Thomas (2) Doud, was born in 1707, died in 1748. He resided in that part of Madison, Connecticut, known as Hammonasett, and was a large land owner. Before his death he took his two sons and, riding on horseback, directed the boys where to drive stakes in a north and south line across his property. He then said to Ebenezer, "The land on that side of the stakes is yours;" to Timothy, "The land on this side is yours." This was his will and the bounds thus fixed yet remain. The estate divided in this manner remained longer in one family than any other in Madison. He had but two sons and a daughter, Lydia.

(V) Ebenezer (2) Doud, the eldest son of Ebenezer (1) Doud, reared a family of eight sons on the homestead received from his father. He was a farmer, and for seven years served as an officer in the Revolutionary army. He endured many hardships during this period which so weakened him that he was an invalid for many years preceding his death. He married Tamar Wilcox and left eight sons, Galen (1), having died in infancy.

(VI) Galen (2) Doud, eighth son of Ebenezer (2) Doud, was born in 1783, died in 1851. He lived at the east end of Boston street, Madison, and was a prominent and influential man in his community, serving the town for many years as justice of the peace and in the state legislature. He married, in 1812, Mary Ward, and had six sons, one dying young, and three daughters.

(VII) Charles Hamilton Doud, second son and third child of Galen (2) and Mary (Ward) Doud, was born in Madison, Connecticut, October 6, 1817, died in Scranton, Pennsylvania, October 12, 1895. In early life he was a seaman, rising to the command of a vessel owned jointly with his brother-in-law, Sereno Scranton, trading with Boston and New York. He left the sea while yet a young man and engaged as a general merchant in Madison. Later he was in business in Augusta, Georgia, returned to Madison, Connecticut, then settled in Scranton, Pennsylvania, where he was a highly respected merchant until his death, October 12, 1895. He was an elder of the Presbyterian church, and a strong, upright character. He married, about 1840, Mary R., daughter of Jonathan Scranton, of Madison, Connecticut, and at their marriage it was said they were the handsomest couple ever wedded in the village. In beauty of character they surely excelled, and in their posterity the traits that characterized the parents are plainly visible. Children: 1. Catherine Josephine, born in 1842; married, in 1864, William L. Wilson, a veteran of the Civil war, cashier and president of the Nebraska City National Bank (Nebraska) 1872 to 1911, dying in the latter year, his wife having preceded him to the grave. 2. Henry Charles, born in Augusta, Georgia, in 1845, died from injuries sustained from falling from a balcony at Asbury Park, Pennsylvania; he was a member of the firm of Maloney, Doud & Company, Scranton; he married Elizabeth Porter and left issue. 3. Erastus Scranton, of whom further. 4. Curtis William, born in Scranton in 1856; became a civil engineer and located in Rochester, New York, where he died, unmarried. 5. Herbert Allison,



born in Scranton in 1859; he is a graduate of Lafayette College and shortly after graduation was appointed to a position in the internal revenue service at Omaha, Nebraska, becoming chief clerk, a position he held until Cleveland's second administration, when he resigned; four years later he again accepted the same position; he is an elder of the First Presbyterian Church of Omaha.

(VIII) Erastus Scranton Doud, second son and third child of Charles Hamilton and Mary (Scranton) Doud, was born in Madison, Connecticut, July 29, 1849. He was educated in the public schools of Scranton, a graduate of the high school, the State Model School, of Trenton, New Jersey, and matriculated in Lafayette College to enter the sophomore class of the latter institution in 1867. On August 26, 1867, he was offered a position as messenger in the First National Bank of Scranton, which he accepted, remaining until April 9, 1872, when he became cashier of the Hazleton (Pennsylvania) Savings Bank, later succeeded by the Hazleton National Bank. Mr. Doud remained with the second named bank until June 1, 1891, when he resigned. He then became interested, with Alvan Markle, in the Lehigh Traction Company, did a great deal of preliminary work in the interest of the company in and around Hazleton, and was president of the construction company that built the third rail line between Hazleton and Wilkes-Barre. From 1901 to 1905 he was secretary of the Wilkes-Barre and Hazleton Railroad Company, making his home in Hazleton until the latter year, locating in Scranton on April 9. He was a public accountant until June 15, 1908, when he became secretary of the Nay Aug Lumber Company, a position he now holds (1914). While residing in Hazleton Mr. Doud was especially active in matters pertaining to public education and as a member of the school board performed valuable service in increasing the usefulness of the public schools.

He is a member of the Masonic Order, belonging to Peter Williamson Lodge, No. 323, F. and A. M., and to all bodies of the Ancient Accepted Scottish Rite, having attained the thirty-second degree. His clubs are the Green Ridge, of Scranton, and the Westmoreland, of Wilkes-Barre, his membership in the latter extending over a period of twenty years. Both Mr. and Mrs. Doud and their sons, Harold and Lawrence F., are members of the Green Ridge Presbyterian Church. In political faith he is a Republican.

Mr. Doud married, April 23, 1873, Ella Augusta Chase, born January 28, 1854, daughter of Joseph and Louisa (Field) Chase. Children: 1. Joseph Chase, born March 18, 1875; married, March 4, 1896, Edith Totten; children: Lois, born in September, 1897, and Marjorie, born in 1899. 2. Walter Scranton, born June 10, 1877; married Laura Becker, of Worcester, Massachusetts, and has a son, Walter Scranton (2), born in 1907. 3. Mabel Louise, born in October, 1879. 4. Eleanor Wilson, born in December, 1881; married Fisher Hazard Leisering, of Connellsville, Pennsylvania; children: Hazard, Louise, Mary. 5. Erastus Raymond, born June 11, 1883; graduate of Lafayette College; married, July 24, 1912, Miss Porter, of Connellsville. 6. Daughter born 1885, died in infancy. 7. Harold, born 1887; now assistant secretary of the Scranton Trust Company; married Margaret Ives, on April 23, 1913, on the fortieth anniversary of his parents' wedding and the twenty-third anniversary of the marriage of the bride's parents. 8. Ruth, born 1889. 9. Lawrence Field, born June 1, 1891; now the Scranton representative of the American Radiator Company.

---

#### CHARLES J. POWELL

Penn Yan, New York, has been for several generations the home of this branch of the Powell family, their settlement there dating from an early day.

Charles J. Powell is the first of his immediate family to make permanent settlement in Scranton, he being attracted here by his uncle, who founded the business of which his nephew is the honored head.

Charles J. Powell is the son of James S. Powell and a grandson of John Powell, all born in Penn Yan. John Powell was a farmer, married Jane Bellows, daughter of Peter Bellows, one of three brothers who settled in Bellows Falls, Vermont. She was a teacher for many years in Penn Yan, New York, and left issue: Lewis Bellows, James S., Mary, Sarah, Charles F., William.

Lewis Bellows Powell, eldest son of John and Jane (Bellows) Powell, was born November 16, 1838, in Penn Yan, New York, died in Scranton, Pennsylvania, August 28, 1881. He was educated in Penn Yan schools and under private tutelage in certain lines of study which his mother taught him, and his first business venture was in Scranton in 1859, establishing the first music store on Lackawanna avenue and brought the first organ and piano to Scranton, controlling twenty-eight counties for the sale of the Chickering Piano and Mason & Hamlin Organ. He adhered to the one price, not deviating an iota. The one price system was the backbone of his success, and advertising judiciously. He was a remarkable reader of human nature and he set an example to young men of business principle that many have appreciated in after life. He was a worker for every good in Scranton, and the Young Men's Christian Association found in him a great supporter. He continued in business from 1859 until his death, though he was not active for the five years preceding his death on account of a protracted illness.

Mr. Powell married, June 28, 1871, Ruth Quiney Trask, born November 18, 1838, daughter of Rev. George and Ruth Q. F. (Packard) Trask, of Fitchburg, Massachusetts, the former named a Congregational minister located in Fitchburg for thirty-three years and until his death in 1875. Mr. Powell was a Mason. He died aged forty-three years, mourned by all who knew him. He was in love with his business, and happy in his home life. He was a great musician and a great business man, a combination not often met with, and was also a Christian gentleman.

James S. Powell, second son of John and Jane (Bellows) Powell, was born at Penn Yan, New York. In early life he learned the blacksmith's trade, and later he engaged in the hardware business for many years. He married Maria Easton, of Middlesex, New York; children: George K., died in 1910; Nellie B., now living in Los Angeles, California; Mary S., died in 1907; Charles J., of whom further.

Charles J. Powell, son of James and Maria (Easton) Powell, was born in Penn Yan, Yates county, New York, August 14, 1856. He was educated in the public schools of Penn Yan and Kingston Seminary, taking a commercial course at the latter institution, graduating in 1874. On April 1, 1875, he came to Scranton, Pennsylvania, entering the employ of his uncle, Lewis Bellows Powell, then engaged in business as a dealer in musical instruments and kindred lines. The young man began at the lowest round of the ladder, was office boy, general helper, etc., until he became familiar with the business, then was advanced to salesman and later confidential clerk and for the last six years of his uncle's life was practically manager of the entire business. He continued as manager of the business for Mrs. L. B. Powell after his uncle's death, and extended the lines until the store became a veritable headquarters for the music trade in Scranton. In 1909 he formed a partnership with C. H. Chandler, and they purchased the stock and good will of L. B. Powell & Company, the firm trading as Powell & Chandler. Mr. Powell is one of the best known men in the trade, has a host of friends and possesses the business qualities that

make for success. He has built up a reputation for honorable dealing and fair treatment that holds his customers to him and makes them his loyal supporters. He was one of the charter members of the first lodge of the Benevolent and Protective Order of Elks, formed in Scranton, and with Frank Jermyn and George Throop was largely instrumental in founding the lodge. Mr. Powell is a Republican in politics, and an attendant of the Methodist Episcopal Church.

Mr. Powell married Edith G., daughter of Ambrose Stark, of Penn Yan, and has children: Elsie S., born September 17, 1885, married John Mac Meekin and resides in Seattle, Washington; Helen S., born November 10, 1886; Frank R., born November 27, 1890, graduate in chemistry, Lafayette College, class of 1912, now in the employ of the Giant Portland Cement Company.

---

#### GUSTAV A. MILLER

Gustav A. Miller, of the ancient German family, is one of the oldest and best known undertakers in the city of Scranton. His grandfather, Michael Miller, had the distinction of being a colonel in that most perfect of military organizations, the German army, and his father, Michael (2) Miller, son of Colonel Michael (1) and Margaretta Miller, was born in Lutzenhausen, Rhine province, Germany, March 17, 1831.

Michael (2) Miller obtained his education in the public schools and at the gymnasium, graduating from the latter when seventeen years of age. It had been his ambition to enter the Germany army as a sharpshooter, and although filling the requirements as to age and education, parental objections so barred the way that he was compelled to relinquish his earnest desire, and was for three years employed as a clerk in the office of a judge. Wearying of this occupation and thwarted in his attempt to choose a career, he resolved to immigrate to the United States, and in fulfillment of that resolution he took passage on the sailing vessel, "Emma," a craft which the following year was wrecked and sank in mid-ocean. It is a peculiar fact that the boat which carried Mr. Miller back to Germany for a visit, in 1889, the "Elba," met the same fate the year after his voyage was taken. After a passage of forty-nine days, uneventful for the most part, the "Emma" made Philadelphia harbor in safety, and Mr. Miller had reached the land of promise. He came immediately to Scranton. It was a period of depression in the mercantile and manufacturing industries and employment was difficult to find, but he finally secured work chopping wood, where the court-house now stands, at wages of forty cents per day. As the various activities and industries of the growing city were once more opened at full pressure under the stimulus of better times, employment became more plentiful, and Mr. Miller entered the service of the Lackawanna Iron and Coal Company in the rolling mill, remaining there for thirteen years and becoming a practical iron roller. In 1863 he established a grocery store in the twelfth ward, remaining in business there for twelve years. Popular and well liked, all of his acquaintances became his patrons, a large and lucrative business resulting from their generous trade. He purchased the site of his present business in 1874, and moved his grocery business to that place, starting, in connection therewith, a livery stable. Eleven years later, when both his grocery and livery businesses were firmly established and steadily paying properties, he lent his name to an enterprise managed by his son, Gustav Adolph Miller, the undertaking business. This, too, met with the success that had attended all of his other dealings, and acquired a well-deserved reputation as one of the leading houses of its kind in the city.

When Mr. Miller retired from active business relations, he placed his son and daughters in charge of his varied interests, built up by him in such a thor-

ough and able manner by the work of his hands and the genius of his mind, the latter seeing the opportunity and the former carrying the plans of the latter to a successful consummation whenever that was possible by dint of hard and unremitting toil. Mr. Miller retained title to five residences and a block in the business section of the city, properties he had acquired as investments with the proceeds from the different undertakings he has planted and nursed to a vigorous maturity.

He was a follower of the faith that has been cherished by the family for many generations, the German Presbyterian. While holding to family tradition in this respect, Mr. Miller broke a time-honored custom of all of his name for many years by not identifying himself with the Masonic fraternity, a Miller of his branch always having been a member of that order. His political beliefs were strongly Republican, and the principles of the party he firmly supported.

Michael Miller married, in Dunmore, in 1852, Maria M. Fickinger, a native of Rhine province, Germany. Children: C. Mary; Gustav Adolph, of whom further; Louisa, married Stephen Spruks, and resides in Scranton. Mr. Miller died November 9, 1904.

Gustav Adolph Miller, son of Michael (2) and Maria M. (Fickinger) Miller, was born July 29, 1860. He attended the public schools and there obtained all the education he ever received under graded instruction. In early youth he entered the employ of his father in the latter's grocery store. In 1878 he went to New York City and there learned undertaking and the art of embalming, and upon his return to Scranton he engaged in business under his father's name, being the first undertaker of the city with a knowledge of embalming. His place of business has always been on the South Side and he is now one of the oldest established undertakers in the city, bearing an excellent reputation backed by years of experience. He has been treasurer of the Liverymen and Undertakers Association since its organization. Mr. Miller is a member of the Masonic Order, is past master of Union Lodge, No. 291, F. and A. M., and belongs to Lackawanna Chapter, Royal Arch Masons, Coeur de Lion Commandery, Knights Templar, Keystone Consistory, Sovereign Princes of the Royal Secret, and is a noble of Lu Lu Temple, Nobles of the Mystic Shrine, of Philadelphia. He also affiliates with James Connell Lodge, No. 170, I. O. O. F., Comet Lodge, No. 413, K. of P., and Camp No. 430, P. O. S. of A. Both he and his wife are members of the German Presbyterian Church and play an active part in all of its associations. He has been treasurer of the Men's Society of the church since the second year of its existence, while his wife and daughter are prominent in the Sunday school organization. He married Clara Bodenstine, of Philadelphia. Children: Mary Louise, and Madeline Spruks.

A lifelong resident of Scranton, Mr. Miller has many warm admirers in the city who are held close to him in the firmest of friendship's ties. The veritable "thousandth man" of whom Kipling tells, he is ever at the service of those who are privileged to know him best. His life is exemplary in character, his influence for the best and far-reaching in its effect.

---

#### ROBERT WILLIAM ALLEN

Prior to his settlement in Scranton, George Allen, father of Robert William Allen, the present efficient commissioner of Lackawanna county, resided in Bath, New York, having settled there on coming to this country. He was born in Ireland, one of a family of five: 1. John, deceased. 2. William, now living in Bath, New York; married Ellen Craig and has children: George;



*G. A. Miller*



Elizabeth, deceased; Annie; May; William, deceased. 3. Richard, deceased. 4. George, see forward. 5. Annie, married Michael Connor and resides in Scranton; children: William, manager of the Armour Beef Company at Wilkes-Barre; Jennie; Thomas, deceased; John and Mary.

George Allen, on coming to Scranton, found employment in the shops of the Delaware, Lackawanna & Western Railroad, became later affiliated with the Knights of Labor and took an active as well as prominent part as one of the leaders of that organization. He became a member of the police force of Scranton, under Terence V. Powderly, and continued thereon until a few years prior to his death, in 1894. He took active part in the division of Luzerne county whereby Lackawanna county was created and was one of the strong men of his day. He married Catherine Smith and had issue: 1. Katherine, deceased. 2. Louise, deceased. 3. Thomas, deceased. 4. George, deceased. 5. Edward, deceased. 6. John, now spinner in a woolen mill; married Annie Kolb and resides in Scranton. 7. Robert William, see forward. 8. Joseph, clerk in the tax commissioner's office; married Ellen Bouton and has seven children.

Robert William Allen was born in Scranton, Pennsylvania, November 12, 1871. He has spent his entire life in the city of his birth, working himself ever upward from a lowly position to one of honor and influence. He was educated in Scranton schools and began his wage earning life as a bell boy in the old Wyoming House then conducted by John E. Allen. He was promoted from bell boy to the billiard room force, continuing with Mr. Allen several years. He then was employed at the Valley House under Fred Godfrey, next spending five years at the old Westminster Hotel. When the Westminster was sold to William McBride, Mr. Allen remained with him one year, then was with Charles S. Gilbert at the Central Park House. He then decided to enter business as proprietor and for three years conducted the Coleman House. In 1903 he was the candidate of his party for register of wills, was elected and served the legal term of three years. In 1906 he was a candidate for re-election, but was defeated at the polls. Until 1908 he was in the employ of the Anthracite Brewing Company as collector. In the latter year he was elected county commissioner and in 1911 re-elected. He has served the county well in official position and has the confidence of the voters as his repeated elections indicate. Mr. Allen is president of the Anthracite Brewing Company, treasurer of the Scranton Base Ball Association and interested in other enterprises of this city. He is a member of the P. O. S. of A., Camp No. 242; B. P. O. E., Lodge No. 123; F. O. E., Eyrie No. 304; Saint Luke's Protestant Episcopal Church. In political faith he is a Republican. Mr. Allen married Catherine Dice, of Hazleton, Pennsylvania, descendant of a German family.

---

#### FRANCIS OSCAR STONE

This is a well known family name in Pennsylvania and one springing from different nationalities. The branch herein followed was planted in Pennsylvania by Benoni Stone, of the New England family, who settled in Waverly, Lackawanna county, where his long life of ninety-five years was spent in farming and farm management. He was the founder of a large and influential family among his children being a son, Oscar.

Oscar Stone was born and grew to manhood in Lackawanna county, Pennsylvania, his residence being at Hawley. He was educated in the public schools and worked on the farm for a time, later being a conductor on the Gravity Road running between Pittston and Hawley. He received a serious injury in a wreck on this road and was unable to continue the active life demanded of a

railroad employee. He later became a stationary engineer at Hawley, continuing until his death at the age of forty-five years. He married Alvira L. Mitchell, of Hollisterville, Wayne county, Pennsylvania, who bore him seven children, two of whom died in childhood: Victor B., of further mention; John M., of Hawley, a railroad man; Earl W., a stone cutter and contractor of Scranton; Sidney S., a train dispatcher on the Erie & Wyoming Railroad; Arthur K., born January 11, 1862, a journalist, editor and proprietor of the News at East Stroudsburg, Pennsylvania, married Minnie A. Turner, deceased.

Victor B. Stone was born in Lackawanna county, Pennsylvania, and resided for many years in Hawley. He was educated in the public schools, and during his early manhood was engaged in the lumber business. He then entered the employ of the Erie Railroad as fireman, received in due time his promotion to engineer and for twenty-five years held the throttle on one of the company's engines. He moved to Scranton in 1888 and here yet resides. He is a member of the Brotherhood of Locomotive Engineers, an independent in politics, and a valued and trusted employee of the company he has served so long and faithfully. He married Mary May Enslin and has children: Francis Oscar, of whom further; Friend A., a foreman; Mark V., chief clerk in the Erie Railroad shops; May; Madge.

Francis Oscar Stone was born at Port Jervis, New York, September 17, 1883. His parents moved to Scranton when he was five years of age and in the public schools of this city he obtained his elementary education, finishing his study at Pennsylvania State College. He began business life in the store department of the Erie Railroad, continuing two years, then was with M. P. Michel until 1906. In that year he became attached to the clerical force of the surveyor of Lackawanna county, continuing in subordinate position until 1911. For a short time he was connected with the engineering department of the Scranton Gas and Water Company, but later in the year was nominated by the Republican party for the office of county surveyor and in the following November election was chosen by the electors of the county to fill that important position which his technical training and years of experience eminently qualified him to fill.

He married, June 14, 1910, Marian E. Swartz, of Dunmore, Pennsylvania, daughter of Frank E. and Emma Swartz; her father vice-president of the Fidelity Deposit and Discount Bank and secretary and treasurer of the Cemetery Association of Dunmore. One daughter, Eleanor Swartz Stone.

---

#### FREDERICK H. EMERY

In the many years spent at the mines as breaker boy, Mr. Emery saw the need of a machine that would separate slate from coal, work of a trying and dangerous character, then performed by boys. He was not the first to invent such a machine, but followed with a perfect picker the inventions of Captain Thomas and Charles W. Zeigler, both of whose machines allowed the loss of more or less coal. So successfully did he plan, that to-day his invention (the Shaker Picker) is in use by the leading coal companies of the anthracite region, and many have been sent to Canada, Wales and England, and Mr. Emery is now in communication with other coal operators in foreign countries. In the anthracite region as well as in the foreign countries, the slate has a flat smooth surface, and is not separated from the coal by the ordinary machine. By the use of the Emery oscillating machine, the slate is given a backward movement carrying it under the coal and through openings underneath into a receptacle, the coal going forward through the regular breaker. The following is an illustration of the machine above described.





*F. H. Emery*



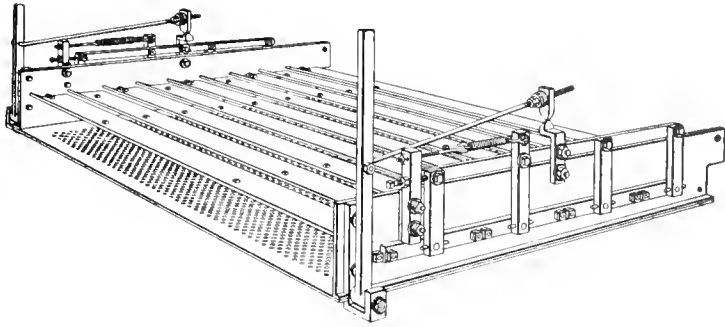

Another machine which Mr. Emery invented is for the purpose of taking out heavy rock and is so constructed that instead of dropping the rock through continuous openings, a portion of the coal is taken away from the slate and is converted into a separate pan; the balance of the coal and rock that drops through the first opening is repeated in the same manner until the final separation is made. Thereby no coal is lost in the process and is entirely free from slate and rock. The following is an illustration of the machine.

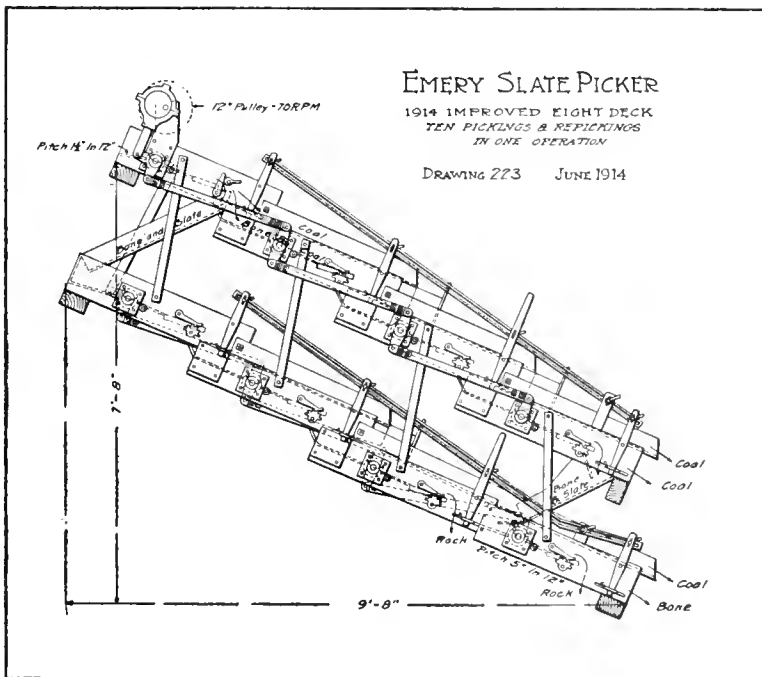

1914 improved eight deck ten pickings and repickings obtained in one operation. Covered by patents issued to F. H. Emery as follows: 599569, March, 1887; 640549, June, 1900; 755472, March, 1904; 784783, March, 1905; 969048, August, 1910. Other patents pending.

The Emery Shaker Picker and the Rock Separator are not the result of a dream or an inspiration, but the result of the labor of years, during the hours

the inventor could spare from his regular duties, and often were hours that could profitably have been spent in sleep. The machines are valuable contributions to the labor saving machinery of this day and reflect the highest credit upon their inventor.

Frederick H. Emery was born in Scranton, Pennsylvania, March 14, 1865, son of George and Anna (Richardson) Emery. George Emery was born in Morganshire, England, and there lived until after his marriage to Anna, daughter of Robert Richardson. They came to the United States about 1863, settling in Scranton, where he followed the occupation of a miner until his death at the age of sixty-two years. He was a member of the Independent Order of Odd Fellows, and both were members of the Methodist Episcopal Church. Children: Elizabeth, Frederick H., Nora, Bertha, Daniel, the latter deceased; a sixth child died young.

Frederick H. Emery attended the public schools of Scranton, but early in life became a breaker boy, later working in the mines and continuing until 1893. During these years he evolved his idea of a slate picker, but so closely was he confined by his duties in the mine that he could find no opportunity to work out his ideas of a picker. In 1893 he abandoned a miner's life and for fourteen years was in government employ at the post office in Scranton. During these years he worked his great invention, the Emery Slate Picker, secured his patents, proved its value, and, resigning his position, began manufacturing the machine. The firm of F. H. Emery & Company was formed, consisting of F. H. Emery, T. R. Hughes and J. R. Richardson, the latter now deceased, the first two named partners taking over his interest. The business of the firm is the manufacture of slate pickers from Mr. Emery's patents, a force of twenty-five men being constantly employed. It is gratifying to note that Mr. Emery reaps the reward of his years of persistent effort and controls both the manufacture and sale of this child of his brain. He has other business interests, principally connected with the coal trade, being a director of the Southwestern Anthracite Coal Company and of the Scranton Anthracite Coal Company, both operating from Clarksville, Kansas. He is a member of the Benevolent and Protective Order of Elks, and in political faith is a Republican.

---

#### CHARLES HENRY LINDSAY

A resident of Scranton since 1870, Mr. Lindsay has been for over forty years connected with important commercial enterprises of the city in positions of trust and responsibility. He was born in Bath, New York, March 9, 1846, son of James and Maria (Richardson) Lindsay, the former born in Sligo, Ireland, in 1799, the latter in Bath, New York, in 1806.

Charles Henry Lindsay obtained a good public school education in Bath and until 1870 was engaged in mercantile business in that city. In that year he came to Scranton where until 1880 he was associated with Hunt Brothers & Company, from 1881 to 1903 with E. I. DuPont de Nemours & Company of Pennsylvania, and from 1885 to the latter year was secretary and treasurer of the Consumers Powder Company. In 1903 he was elected treasurer of DuPont de Nemours & Company of Pennsylvania and as such continues at the present date (1914). In addition, from 1877 to 1891, he was manager of the Academy of Music. The family are members of Green Ridge Presbyterian Church, and in political faith Mr. Lindsay is a Republican.

He married, in Washington, D. C., October 5, 1886, Annie Mitchell, daughter of William H. and Eliza (Cropley) Tenney, of that city. Children: William Tenney, now clerk in the First National Bank of Scranton; Carl Ludovic, now clerk for the Scranton Lace Curtain Company; Louise; Stewart. The family residence is No. 1631 Washington avenue, Scranton.



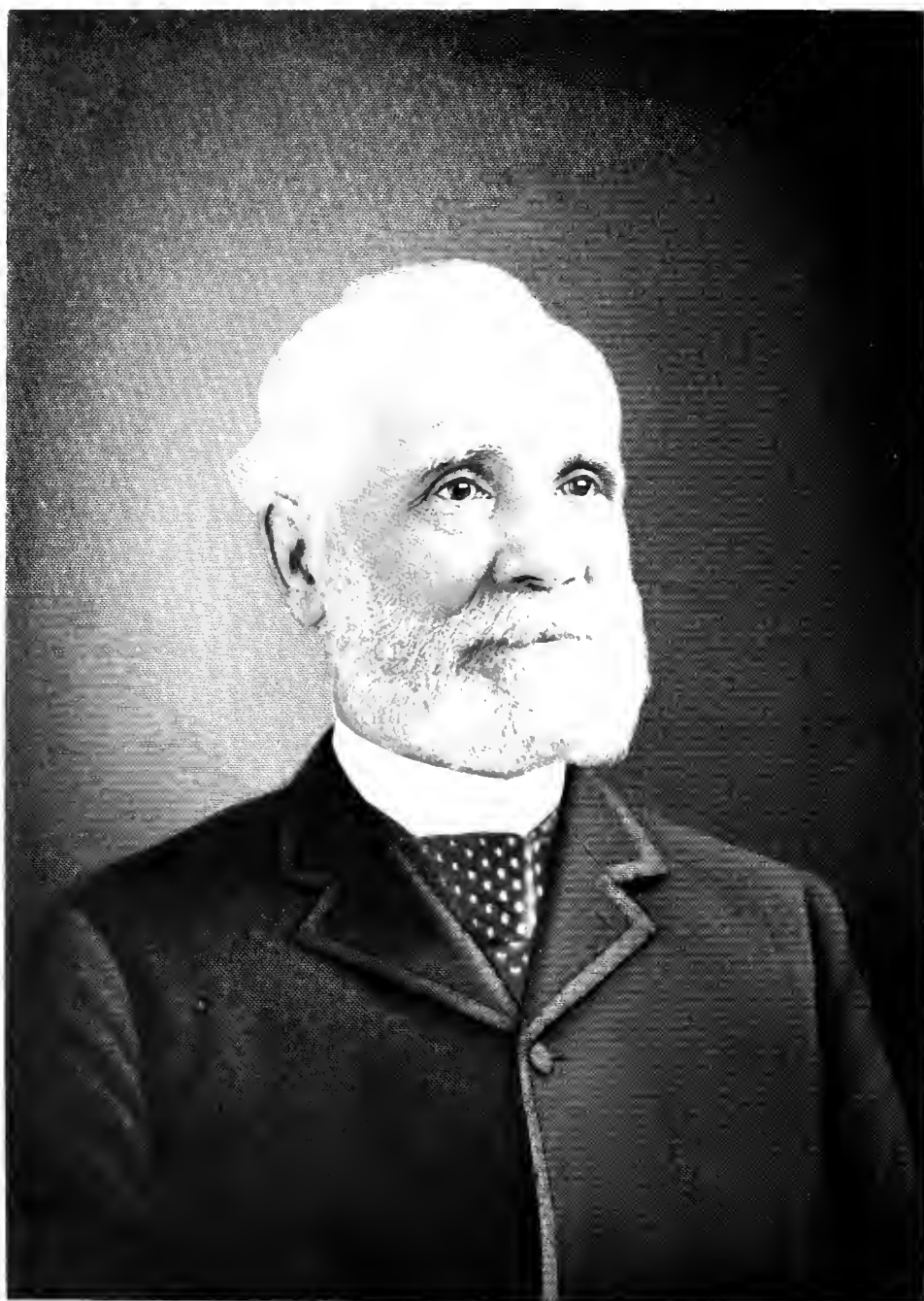

*Prof. Black*

## ROBERT THOMPSON BLACK

When the history of Scranton and her public men shall have been completed its pages will bear no more illustrious name and record, no more distinguished career than that of the late Robert Thompson Black, in whose demise the city of Scranton lost one of its representative citizens, a man of uncompromising integrity, unassailable character, keen perception and shrewd judgment, an active and potent factor in the financial and mercantile affairs of his adopted city, whose aggressive opposition to public or private fraud made him a man whose influence invariably assisted in turning the balances in favor of the right.

Robert Thompson Black was born October 1, 1821, in Rath Melton, six miles from Londonderry, county Donegal, Ireland, a descendant of a Scotch-Irish lineage. He was reared to maturity in his native town, attended the district school, and in 1842, upon attaining his majority, emigrated to the United States, sailing from Londonderry on the ship Lafayette, arriving in Philadelphia, Pennsylvania, the journey covering a period of six weeks. From Philadelphia he removed to Zanesville, Ohio, where he clerked for a time in a store owned by his brothers, John and Peter Black, later assumed charge of a store in McConnellsville, Ohio, and subsequently removed to Springfield, Ohio, where he engaged in the retail mercantile trade, continuing along that line for eight years, during which time he achieved a large degree of success. He then returned to Philadelphia and directed his attention to the dry goods business, purchasing an interest in the firm of Eschrick, Penn & Company, he assuming the active management of the business, which prospered abundantly under his control, he being progressive in his ideas, although conservative in his methods, and later he was actively engaged in the coal business, which was also a lucrative enterprise. In 1861 he disposed of his interest in the firm of Eschrick, Penn & Company to his brother, and in 1866 removed to Wilkes-Barre, Pennsylvania, and there became connected with the Vulcan Iron Works and later turned his attention to the coal business, in which he had become an expert.

In 1867 Mr. Black took up his residence in Scranton, Pennsylvania, and there spent the remainder of his days, residing there for more than three decades, being busily engaged in divers pursuits. His first business venture after moving to Scranton was in connection with two brothers-in-law in coal operations at Minooka; later he was appointed treasurer and general manager of the Pennsylvania and Susquehanna Coal Company, which at first had but one colliery, but Mr. Black built another and operated the two for a number of years, making shipments by the Delaware & Hudson and Delaware, Lackawanna & Western railroads, the business growing steadily in volume and importance under his competent guidance and excellent administration of affairs. About the year 1878 he disposed of his interest in the company.

During the period of his residence in Scranton Mr. Black was actively and prominently identified with many leading enterprises which had for their object the welfare and progress of the city. He assisted in the organization of the Second National Bank, of Wilkes-Barre, of which he was a director for more than twenty years, and at different times served as vice-president and president of the Lackawanna Valley Bank, of Scranton, holding the latter position at the time of its reorganization as the Lackawanna Trust and Safe Deposit Company, and was a director of the concern at the time of his decease. He was a shrewd investor, a close scrutinizer and conservative adviser, and he knew the value of bank stock, government bonds and securities as very few of his compatriots did, hence his value in high official positions, which he filled acceptably and commendably.

For six years Mr. Black represented the eighth ward upon the board of control, and also held the position of member of the poor board for a number of years, finally tendering his resignation. He was a staunch adherent of the principles of the Republican party, in whose interests he labored faithfully, but he steadfastly declined nomination for local office, preferring to render his service in a less conspicuous manner. He was a vigorous fighter in the cause of good government against lawlessness. In the memorable series of prosecutions by the Young Men's Christian Association, and successively conducted by its presidents, Colonel Henry M. Boies and Edward B. Sturges, in the early seventies, against saloon keepers for violation of the liquor laws, Mr. Black was the financial backer, and again in 1876 he rendered a like service in the graft prosecution of F. A. Beamish.

During his later years Mr. Black withdrew somewhat from the public eye and from the active furtherance of public work, but he never ceased to hold a gentle sway in the hearts of countless friends, to whom his demise was a sad affliction. He loved humanity and was never content unless doing something for others, but his charity was simple and was prompted by the purest motives of a kindly and sympathetic heart. Especially in his later years he possessed a most striking personality; having a full head of hair as white as snow and by contrast a fair and ruddy complexion; an extremely vivacious manner of speech and a high keyed treble voice; plain in dress, invariably wearing the conventional black. He had a remarkable memory and his mind was a storehouse of facts, incidents and reminiscences, and he enjoyed a good joke and could tell many. He was a member of the First Presbyterian Church of Scranton, in the work of which he took an active interest.

Mr. Black married, July 15, 1858, Caroline A. Perkins, who survived him. Children: Robert Thompson Jr., who was a resident of Scranton, died in 1907; Thomas Atherton, a resident of Scranton; Mary S., who became the wife of C. E. Judson, of Wyoming, who for a number of years has managed an extensive cattle ranch in that state belonging to the late Mr. Black. Around the fireside of his happy home, surrounded by his family that he loved dearly, Mr. Black passed many of his happiest hours, enjoying to the full their companionship and love. He was a loving husband, an indulgent father, a good friend, a kind person, an estimable citizen and an honest man, which tribute is more to be desired than any other.

Mr. Black died at his home in Scranton, May 25, 1900, and interment was made in the family vault in Dunmore Cemetery. The funeral services were conducted by the Rev. James McLeod, pastor of the First Presbyterian Church, and the Rev. Dr. Logan, both of whom spoke eulogistically of the character of the deceased. The following was Dr. Logan's tribute:

It is fully fifty years since I first met Mr. Black, and for twenty-five years I held toward him the intimacy of a recognized pastor. When I first met him he had recently arrived in the county and was hard at work on what was then the frontier. With a Scotch ancestry and an Irish birth-place, he belonged to that race of Presbyterians—the Scotch-Irish—who placed the Presbyterian church in this country. He called himself a Presbyterian. I once told him I thought him more of a Presbyterian than a Christian, and he said he was. From early life he had connected himself with the church, but in the active and multifarious contact with the world in business, for a time he departed from it, and it was my privilege to bring him back to the church in which he maintained his worthy Christian life through the last half of it.

Robert Black was a man of strong characteristics. Honest and true in whatever he undertook, he was the kind of stuff out of which the citizenship of such a land as this is made. His life was energetic, industrious and kind, and he was more than ordinarily successful. There was stalwart truthfulness without effort at polish and yet in his heart a kindness and geniality which always bound men to him. During the last thirty years he walked among us engaged in great personal enterprises, but always ready to work



and sacrifice for the building up of a Christian city. His courage in resisting the wrongs in our citizenship and maintaining the right was more than conspicuous. Twenty-three years ago, when the honest and good citizens of Scranton were searching for friends to protect them from dishonesty in office, from ignorance and vice in our citizenship, he was found among the first.

Just as in the day when the nation was searching in all byways for men who by strength and sacrifice could save the country in the dreadful war, he was true and perpetually active, and his manliness and steadfastness ought to be remembered. There is preserved in the archives of this city and in the archives of his family, I trust, a worthy testimonial to the fidelity and honest and worthy citizen's sacrifice of Robert Black. It is where all the best men of the city have certified to his devotion and testimony for the right. His service is a part of the heritage of this peaceful and prosperous city.

He had his faults, but we can as Christians speak no evil of the dead; even the heathen would not do that. He was rugged and too earnest and honest to spend his time polishing down his points of contact with the forces he proposed to meet and perhaps men of as good qualities as he may have done the same work with less friction, but, with all which seemed to be rugged badness, to the worthy and true, he always manifested a great, generous heart. And his work has gone into the warp and woof of those labors and sacrifices which have made our city a joy and blessing to the coming generation.

Our life is indeed short and busy, and it is very easy for him who is spared to respectable old age to find his work entirely forgotten. The children enter into the heritage of the fathers, and in a very short possession will apply it as their own. Yet it is true that God does not forget; the worthy life will have its telling power, and the virtuous, honest citizenship resigned shall still remain a potency which God himself will demonstrate in the end of the days.

As Mr. Black's old friend and pastor, I feel it to be a pleasure to recall his rugged manly, patriotic and honest life. And there are many within the sound of my voice who, I know, will appreciate the tribute which I have brought to his memory. He was not only a man that aimed to do right, but had no hesitancy in using all the power that God gave him to make others do likewise.

Our sympathies go out to his family, where as husband and father he was its light and in whose joys and sorrows he always appeared at his best. Let us all realize that our time is short, and what we do for ourselves, for our country and for our God must be done speedily. Let us gird ourselves and go forward with new zeal, realizing that it is not vain to serve God, and work righteousness among our fellowmen.

---

### JOSEPH CURTIS PLATT

To Joseph Curtis Platt, who came to the present site of Scranton in 1846, the city owes much of its early prosperity and present greatness. He had married in his boyhood home, Connecticut, Catherine Serena Scranton, and when Slocum Hollow emerged from its chrysalis condition, took on manufacturing dignity and demanded a more suitable name, he was instrumental in securing the adoption of the name of Scranton, out of compliment to Messrs. George W., Selden T., and Joseph H. Scranton.

The Platts, of Scranton, are of the Saybrook, Connecticut, branch, descendants of Frederick Platt, who settled in Killingworth, Connecticut, about 1790, supposedly a descendant of Richard Platt, the emigrant of 1638, who settled at New Haven and Milford, Connecticut. At the latter place, among the coping stones of the beautiful memorial bridge over the Wapawaug to perpetuate the memory of the early settlers, is one bearing this inscription:

Deacon  
Richard Platt  
Obit 1684  
Mary His Wife.

Frederick Platt married a Miss Fox, of New London, Connecticut. His third son married Hannah Lane and located at Saybrook in the part now called Winthrop. Captain Dan Platt, son of Obadiah Platt, was an officer of the Revolutionary army. He was born 1735, died aged eighty-eight years. He

married, January 12, 1763, Jemima Pratt. Deacon Dan Platt, son of Captain Dan Platt, was born June 21, 1764, married Catherine Lane, December 20, 1787, and died in Madison, Connecticut, aged over seventy-eight years. He had five sons and five daughters. Joseph Platt, eldest son of Deacon Dan Platt, was born in 1789, married Lydia Pratt, and died aged thirty-seven years. He was a lawyer and an associate of the father of Chief Justice Waite of the United States Supreme Court.

Joseph Curtis Platt, son of Joseph Platt, the lawyer, was born in Saybrook, Connecticut, September 17, 1816. Left fatherless when ten years of age, he began at eleven years to earn his own living as clerk in a country store. In 1836 he had accumulated sufficient capital to begin business for himself. He opened a general store at Fair Haven, Connecticut, carried on a successful business there for eight years, then married and two years later moved to Scranton, Pennsylvania. His marriage, April 2, 1844, to Catherine S., daughter of Jonathan Scranton, of Madison, Connecticut, was the cause of this removal. Her brother had become deeply interested in iron manufacture in the Lackawanna Valley, the company also operating a store which in 1846 needed a new manager. Joseph H. Scranton, on one of his trips East, persuaded his brother-in-law, Mr. Platt, to visit the Valley in November, 1845. The result of this visit was that the following year, having converted his property into cash, interested his friends with capital to also invest, he located in Slocum Hollow to the everlasting benefit of the then village, now city. To illustrate the change in transportation facilities, Mr. Platt later in life wrote the following account of his coming to Scranton with his little family in March, 1846:

There being no railroad we came by night steamer from New Haven, and arriving in New York, the next morning found the streets so full of snow that our carriage could hardly get to the Franklin House on Broadway, corner of Dey street. After breakfast we found it impossible to get a carriage to take us to the ferry at the foot of Cortland street, on account of the depth of the snow, consequently we had to walk, and a hand cart took our baggage. At that time the Morris and Essex Railroad only ran between Newark and Morristown. Our car was hauled by the Camden and Amboy Company over its road to Newark where it was disconnected and drawn by four horses up the same heavy grade that is now operated by steam. From this point we were taken by a locomotive with one pair of driving wheels to Morristown. At Summit Station we found a novel plan for supplying the engine with water. A pair of wheels on a line of shafting were placed beneath the track, the upper side of them being in line and level with its top. The locomotive was chained with its drivers resting on the wheels beneath its track, when the engineer put on steam and pumped what water he needed. At Morristown we took a stage and arrived at Oxford about dark. There we spent about a week, owing partly to a heavy rain which had so raised the Delaware River that we had to cross it by the bridge at Belvidere and struck the river again at what is now Portland. We were delayed in the Water Gap by ice and logs in the road. After covering small bridges with slabs of wood hauled out of the river, we finally reached Tannersville and spent the night. The next morning, finding good sleighing at Forks, we changed our vehicle to runners and again for wheels at Greenville (now Nay-Aug) and arrived at Selden T. Scranton's house about dark March 17, 1846, the traveling time being one day from New York to Oxford and two more to reach here. At present the trip is made over substantially the same route in 4½ hours and from New Haven in 8 hours. This route generally took 2½ days to or from New York and was the usual one followed. The only way to shorten the time was to take the stage at Hyde Park at noon and riding through the night reach Middletown, New York, in the afternoon, then taking the Erie Railroad to Piermont and steamer down the Hudson, arriving in New York about 6 P. M. the next day after leaving home.

April 1, 1846, Sanford Grant, having retired from the association with the Scrantons and their iron and coal enterprises, Mr. Platt took charge of the store operated by them, and in November of that year the firm was reorganized as Scrantons & Platt, with a capital of two hundred and fifty thousand dollars

Later in the same year Joseph H. Scranton and Mr. Platt purchased the interest of E. C. Scranton, the firm continuing as Scrantons & Platt until 1853, when having far outgrown their original plans, the business was incorporated as the Lackawanna Iron and Coal Company. In all the formative period of the new settlement on the Lackawanna, the laying out of the town plot of lots, the founding of its churches, schools, lodges, etc., Mr. Platt bore a leading part and it is to him that Scranton owes its broad straight streets and all the liberal features of the original plan. In 1850 the first steps were taken to lay out the village plot and of this Mr. Platt writes: "I felt it a matter of importance to start right and held many consultations with Joel Anderson, the engineer." So interested was he in the planning and building of the town that this department was given into his full charge, and until he retired from active business in 1874 he continued in full charge of the company's real estate interests with the title of vice-president.

In 1856 the borough of Scranton was organized, Mr. Platt becoming one of the members of the first council. On August 27, 1858, the first Young Men's Christian Association was organized with Mr. Platt as one of its managers. On March 20, 1862, the Dickson Manufacturing Company was organized for the manufacture of machinery needed in many plants starting in the Lackawanna Valley. Of this company he was one of the first directors, for a number of years was treasurer, continuing as director until his death. In 1863 the First National Bank was organized with Mr. Platt a member of the board of directors. In 1864 he became a member of the milling and grain firm of C. T. Weston & Company. In 1865 he was chosen superintendent of the Sunday school of the First Presbyterian Church. The great demand for powder to be used in the blasting demanded a better source of supply, and in April, 1865, the Moosic Powder Company was formed with Mr. Platt a director, this connection continuing until death, he also serving for a time as treasurer. In 1867-1868 the mercantile interests of the Lackawanna Iron and Coal Company demanding enlarged quarters, a large and commodious store building was erected under Mr. Platt's plans and direction. In 1871 he became a director of the People's Street Railroad Company. In August, 1872, he was elected vice-president of the Lackawanna Iron and Steel Company and the same year was chosen vice-president of the First National Bank, a position to which he was annually re-elected until his death. In 1874 the firm of C. F. Weston & Company was incorporated as the Weston Mill Company, with Mr. Platt as director, and the same year he became a director of the re-organized Lackawanna Hospital.

But now the heavy burdens he had carried since a boy of ten years, and the demands of fifty years of a busy and useful life, made themselves felt and he determined to spend the afternoon of life in a less strenuous manner. To this end he resigned his office of vice-president of the Lackawanna Iron and Coal Company in 1874 and seriously tried to retire from the more arduous of his activities—but in vain—he could not shake off the habits of a lifetime and soon he was again in even heavier harness. In 1876 he became a director of the Riverton Mills Company of Virginia, an offshoot from the Weston Mills Company. In 1877 he resigned as superintendent of the Sunday school after twelve years service. In 1879 he was elected secretary and treasurer of the People's Street Railway Company, and the same year became a member of the First Board of Health of the City of Scranton. In 1880 he was chosen a director of the Lackawanna Iron and Coal Company, and in 1882 a director of the newly finished Moses Taylor Hospital. In 1883 he joined with others in the creation of an institution to bring "speech to the silent" and accepted a directorship on the board governing the Pennsylvania Oral School for Deaf

Mutes, one of Scranton's most successful and characteristic philanthropies. In 1886 he was chosen director of the newly formed "Lackawanna Institute of History and Science." In 1887 he resigned as secretary and treasurer of the People's Street Railway Company, but the same year became a director of the Scranton Forging Company, a new company transplanted from Connecticut.

In July, 1887, he experienced a great grief in the death of his wife, whom forty-three years previous he had led to the altar and whose loss he was destined not long to survive. He had now reached the age of seventy-one years, sixty of which had been years of business activity, seldom equalled. He was in full possession of his physical and mental faculties, when, in October, 1887, he was suddenly stricken with that dread disease, paralysis, and although provided with the best medical attention and every comfort, he did not recover, but on November 15 following, his spirit fled its mortal frame and on unseen wings, joined his life's mate in the "house of many mansions."

This brief review of the life of one of Scranton's "benefactors" shows imperfectly how much he did and how well he performed his every duty. He died "in the harness," although in his latter years he labored less for the material things, becoming more and more interested in plans and enterprises for the betterment of his fellow men and the relief of suffering humanity. The year prior to his death he contributed to the archives of the Lackawanna Institute a valuable historical paper, containing a full account of the development of the Lackawanna Valley from the view point of an actual participant. This paper since his death has been printed and is a recognized authority on the period and events it covers. The life work of Joseph Curtis Platt shows him to have been possessed of more than average ability and good judgment, but the mainspring of his success was his untiring energy, reinforced by indomitable courage. He lived the simple life and cared little for wealth, except for the opportunity it gave him to carry out ambitious plans for the good of Scranton and her people. He retained his connection with the corporations previously named, and on his death his associates in each expressed their profound sorrow by appropriate resolutions. He is buried in Dunmore Cemetery by the side of his beloved wife.

As previously stated, Mr. Platt married, April 2, 1844, Catherine Serena, daughter of Jonathan Scranton, of Madison, Connecticut, and sister of the Scranton brothers famed in early annals of the city that bears their name. She died July 4, 1887, preceding her husband to the grave by about four months, they having enjoyed an ideal married life of forty-three years. Children: 1. Joseph Curtis Jr., (q. v.). 2. Ella J., a resident of Scranton until her death, January 28, 1908. 3. Frank Elbert, of whom further.

Frank Elbert Platt, youngest son of Joseph Curtis and Catherine Serena (Scranton) Platt, was born in Scranton, February 21, 1859. After preparation at the Peekskill Military Academy he entered Rensselaer Polytechnic Institute of Troy, New York, whence he was graduated with the degree of Civil Engineer, in the class of 1879. After his graduation he followed his profession as civil engineer for several years in the Water Works Department of the City of Troy, in the bridge department of the Delaware & Hudson Company and on the preliminary survey and location of the New York, Lackawanna & Western Railroad between Binghamton and Buffalo under the late James Archbald, chief engineer. He then turned his attention to iron manufacture and was uniformly successful as superintendent of the blast furnaces of the Franklin Iron Works, Clinton, New York, of the Hudson River Iron Ore Company, Cold Spring, New York, and of the Chestnut Hill Iron Ore Company, Columbia, Lancaster county, Pennsylvania.

On the death of his father, the settlement and management of his estate

recalled him to Scranton where he has since resided. He has become identified with many of the business enterprises with which his father had been associated. He is a director in the following local corporations: The Scranton Coal Company, Pine Hill Coal Company, Elk Hill Coal and Iron Company, Scranton Electric Construction Company, Susquehanna County Light and Power Company, The Penn Store Company, Central Realty Company, Keystone Store Company, Dickson Store Company, Lackawanna Institute of History and Science, the Pennsylvania Oral School for the Deaf, and the Scranton Forging Company. He has been a director of the First National Bank of Scranton since 1905. He is a member of the University Club of New York, of the Scranton Club, the Engineers Club, and is president of the Country Club of Scranton. For the past twenty years he has been assistant treasurer of the Scranton Coal Company which operates thirteen collieries along the line of the New York, Ontario & Western Railway Company. He possesses not only the technical skill of the trained engineer, but the wise business sagacity required of the modern business man, an equipment rendering him a valuable acquisition to the companies in which he is interested. With cultured tastes and instincts he enjoys the world of art, science and literature, and the pleasures of a gentleman of means. In political faith he affiliates with the Republican party, and in religious preference is a Presbyterian.

Frank Elbert Platt married Elizabeth Augusta Skinner, of Guilford, Connecticut, born 1860. Children: 1. Margaret Scranton, born in New York City. 2. Joseph Curtis (3), born in Cold Spring, New York, November 18, 1887; graduated from Yale, 1910; business, lumber. 3. Philip Skinner, born in Scranton, November 26, 1889; graduated from Yale, 1912; business, public health and hygiene. 4. Leonard Scranton, born in Scranton, June 12, 1900.

---

#### FREDERICK JOSEPH PLATT

Joseph Curtis (2) Platt, son of Joseph Curtis (1) Platt (q. v.), was born in Fair Haven, Connecticut, January 9, 1845, died in Waterford, New York, July 7, 1898. The year following his birth, his parents moved to what is now the city of Scranton, an interesting story of their journey being given in the preceding sketch. The boyhood of Joseph C. Platt was spent in Scranton and his early education there obtained. He prepared at Phillip's Andover Academy, whence he was graduated, class of 1862, then entered Rensselaer Polytechnic Institute, Troy, New York, continuing until 1866, when he was graduated with the class of that year receiving the degree for which he had qualified, that of Civil Engineer. His youthful manhood was spent in the services of the Lackawanna Iron and Coal Company of Scranton, where he added to his previous qualifications those of a mining engineer. He rose to eminence in his dual professions and in iron manufacture, and while still a young man had, as consulting engineer, charge of the construction and later operations of the Franklin Furnaces in New Jersey, then considered a very large and important iron manufacturing plant. He remained at Franklin Furnace until 1875, when he moved to Waterford, New York, where for nearly twenty years he was one of the leading manufacturers. He was president of the Mohawk and Hudson Manufacturing Company and of its successor, the Eddy Valve Company, also proprietor of the Button Boiler Company, leading industries of that section. He retired from active business life during his last years, devoting himself to his earlier professional pursuits by the preparation of essays on technical engineering subjects for the scientific journals.

He was a successful man in both professional and business life, held to the highest code of honor and followed his convictions with fearless and out-

spoken candor. He was ever an enemy of the liquor traffic, denouncing it publicly and privately, fighting it almost single handed in his town. Yet so consistent was his life and so honorable and open his opposition, that he was held by the liquor men in greater respect than any other man in Waterford. In religious faith he was a Presbyterian, was a trustee of the Waterford congregation, chairman of its finance committee, and for several years superintendent of the Sunday school. He also took a deep interest in all charitable and benevolent work, contributing liberally of his time, good judgment and means.

Joseph Curtis Platt married, December 8, 1869, Katherine Judd Jones, of Penn Yan, New York, daughter of Ebenezer Backus (2) Jones, born in Troy, New York, September 5, 1808, died May 24, 1892, and his wife, Lucy (Judd) Jones, born in Rhinebeck, New York, in 1812, died September 1, 1889. Mr. Jones, a successful man of high character, was engaged for many years in the mercantile business in Penn Yan, a son of Ebenezer Backus (1) Jones, of Troy. Lucy (Judd) Jones was a daughter of Uri Judd, of Woodbury, Connecticut. Children of Joseph Curtis Platt: 1. Frederick Joseph, of whom further. 2. Llewellyn Jones, born at Franklin Furnace, New Jersey, July 23, 1873, died in Scranton, Pennsylvania, July 15, 1876. 3. Elbert Scranton, born December 21, 1876; graduate of Rensselaer Polytechnic Institute, now in the chemical department of that institution in Troy, New York; married Angelica Schuyler Thompson, and has a son, Elbert Scranton Platt. 4. Edward Howard, born November 5, 1878, died in infancy.

Frederick Joseph Platt, eldest son of Joseph Curtis (2) and Katherine Judd (Jones) Platt, was born at Franklin Furnace, New Jersey, July 21, 1871. He prepared for college at the Peekskill Military Academy, Peekskill, New York, then entered Cornell University, pursuing the full mechanical and electrical engineering course and was graduated M. E., class of 1892. He later located in Scranton, where he has attained eminence as an electrical and mechanical engineer. He is president of the Scranton Electrical Construction Company, and treasurer of the Susquehanna County Light and Power Company, director of County Savings Bank, director of Scranton Trust Company, director of United Service Company, and has other business interests of importance. He is a Kappa Alpha, a Republican in politics, and a member of the Scranton Club and Scranton Engineers' Club.

Mr. Platt married, January 24, 1895, Jessie Gay Blair, of Scranton. Children: Joseph Curtis (3), Austin Blair, Frederick.

---

#### ARCHIBALD F. LAW

There has been much in the history of the Law family in Pennsylvania to make the name honored among the most celebrated of the state. Inseparably connected with the coal mining industry in the first generation in this country, a pillar of the mercantile world in the second, and a power in many of the industrial enterprises of the present day, one of the name has ever been a prominent figure ever since the United States became the scene of the family's conquests. The Laws are of great antiquity in Scotland and its members in that country have been elevated to positions of height in professional and civil life. The fruits of the latter generation are but the realization of the promise of earlier days.

(1) Archibald Law, grandfather of Archibald F. Law, was the chief engineer in Scotland of the Duke of Buccleuch, and he came to this country on the invitation of the Delaware & Hudson Railroad to take charge of their extensive mining operations. This was in 1830, when he was thirty-one years of age, and to him is due the praise for the introduction of the present method



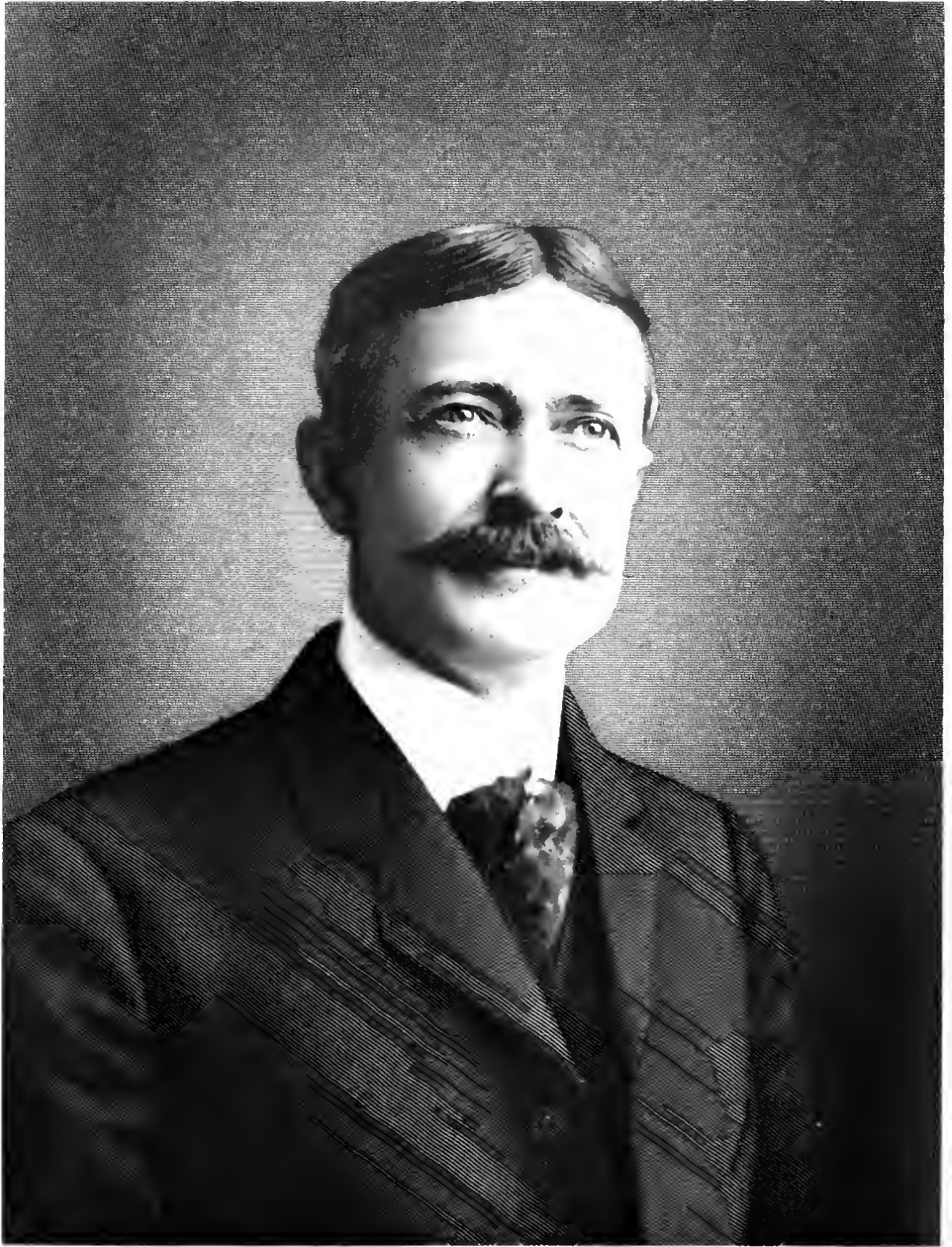

*A. J. Lane,*



of underground mining used in place of the system then in vogue, the working of the vein from the surface by stripping or quarrying. At Wanlockhead, Scotland, his birth-place, he had been taught the profession of mining engineering, and upon his arrival in Pennsylvania he obtained employment with the Delaware & Hudson Coal Company in that capacity. His extended knowledge of his profession, gained from a close study of the properties of anthracite and the best methods of working, soon made him a recognized authority upon these subjects, and the innovation he introduced in the extraction of coal only served to add to his fame and increase his prestige in his field of operations. It was Mr. Law's efficiency in mining matters that led to the accident causing his death. Although he suffered severe injuries in the year 1836 by a falling roof in a mine, that was only incidental to the life of a miner and was a part of the daily risk run by all who elected to spend their working hours buried beneath thousands of tons of earth and rock, far below the light of day. His really fatal injury was received in 1843, after he had been promoted to the office of chief mining engineer and first inspector of coal, to determine its qualities of combustion, appointed by the Delaware & Hudson Company. It was necessary that an inspection of the mine pumps be made, a duty requiring the services of an expert engineer and involving the life and safety of hundreds of miners, one which no conscientious and honorable engineer could assign to a subordinate. While engaged in his task a mass of slate roofing fell, severely injuring his spine and permanently disabling him, its effects hastening his death, which occurred in 1848. That a life from which so much of usefulness was expected in the service of his fellowmen should be so unduly shortened was indeed deplorable. In commemoration of his momentous revolution of the mining industry, a massive monument was erected on the occasion of the fiftieth anniversary of the city of Carbondale, marking the spot first worked in this manner and honoring the man introducing it.

(II) Charles Law, father of Archibald F. Law, was born in Carbondale, Pennsylvania, in 1833, and there attended the public schools. His business life began at the early age of thirteen years, when he became an indentured apprentice to the mercantile business in an establishment conducted by Law & Howell, the senior partner being his elder brother. After eight years spent in the service of others, he established a mercantile business in Pittston under the firm name of Charles Law & Company, which was subsequently changed to Law & Campbell, so continuing until 1878, when Mr. Law withdrew from the firm, at that time conducting an extensive business. After his retirement from this field, Mr. Law contracted connections with many important enterprises about Pittston, and was actively engaged until his death, the Hendrick Manufacturing Company of Carbondale being one of his chief interests. He married, November 25, 1854, Ellen Atwater, daughter of Charles Atwater, an early merchant and postmaster of Providence, Pennsylvania. The Atwaters were of English origin, and were among the first settlers of New Haven, Connecticut, and Providence Plantations, Pennsylvania, all of the name in this country tracing to David Atwater, the immigrant. On November 25, 1904, Mr. and Mrs. Law celebrated their golden wedding anniversary.

(III) Archibald F. Law, eldest of a family of ten children of Charles and Ellen (Atwater) Law, was born in Pittston, Pennsylvania, June 21, 1856, died at his home in Scranton, Pennsylvania, July 18, 1914. He was educated in the public schools and by private tutors in preparation for a college course, but having an inclination for active work he did not complete the course and began his business career in the employ of the Lehigh Valley Railroad at Coxton, Pennsylvania, in the capacity of weighmaster, and as such was engaged at Pittston for a period of six years. From 1879 to 1885 he was cashier of the

Canada Southern Railway, at Buffalo, New York, acquiring a good knowledge of modern railroading, and in the latter named year became connected with the large coal operating firm of Simpson & Watkins at Scranton as secretary and confidential man. Finding the occupation well to his liking, Mr. Law acquainted himself with all departments of the business, subsequently acquiring an interest therein. In 1899 the interest of this firm was merged with that of the Temple Iron Company, Mr. Law being made secretary. Later the duties of treasurer were added to those of this office, while shortly afterward he was made vice-president, with absolute control over the entire administration of the business of the company, a position of great responsibility, which he held until the dissolution of the Temple Iron Company in April, 1914. The business of the company included the furnace at Temple, Berks county, Pennsylvania, and the eight collieries in Lackawanna and Luzerne counties, namely: The Northwest, Edgerton, Babylon, Mount Lockout, Forty Fort, Sterrick Creek, Harry E. and Lackawanna, employing in all eight thousand men. He had in him the true American spirit of fair play, and was always personally responsible to his employees for any official action, his equable disposition and genial personality rendering impossible all of the conflict so often found between employer and employed. So considerate had he been of the rights and needs of the host of men dependent upon him, and upon whom he depended, that no formal request within reason was ever refused them, while many of their desires were anticipated and fair action taken.

In addition to the responsibilities of this office, to which most of his time was devoted, he was actively connected with the following industrial and financial organizations: The Northwest Coal Company, of which he was president; the Edgerton Coal Company, of which he was president; Mt. Pleasant Coal Company, of which he was president; Sterrick Creek Coal Company, of which he was president; Babylon Coal Company, of which he was president; Forty Fort Coal Company, of which he was president; the Cross Engineering Company, manufacturers of mining machinery, of which he was president, which company recently, owing to their greatly increased business, gave their employees a bonus of five per cent. on their earnings for the past year, they having in their employ about fifty men, the amounts varying from \$30.00 to \$50.00, and to Mr. Law is due the credit of instituting the profit-sharing plan in Lackawanna county; the Wyoming Electric Light & Power Company, of which he was president; the Mears Mining Company of Joplin, Missouri, of which he was director and treasurer; the Title Guaranty and Surety Company, of which he was a director; the Peckville National Bank, the Scranton Trust Company, the Forty Fort Silk Company and the Lytle Store Company, at Minersville, in all of which he was a director. Mr. Law's knowledge of each of the industries and organizations was complete, thorough and systematic, the policy of each and the state of its business all being the property of his wonderfully retentive mind.

It is doubtful whether a college education could have improved Mr. Law's literary tastes or widened the fields open to him in that direction. With a strong instinct for all that is best in the world of letters, he found his chief recreation in the recesses of his library, a large well-filled room, the shelves stocked with all the works of the classics and the best of modern authors. Many of his books are so rarely valuable as to make duplication almost impossible and in these he took the fond pride of the literary connoisseur. While continued and diligent reading often tends toward an absorption almost selfish, Mr. Law escaped the construction of the only evil that could result from deep pursuit of the master writers of the world, and ever delighted to have others participate in his pleasures. To this end he was primarily the founder of the

A. F. Law Library Association, which was given his name in recognition of his generosity and public spirit. To this institution, dedicated at Jessup, January 24, 1905, in the presence of over 1000 of the townspeople, deeply appreciative and grateful, he contributed more than 1000 carefully selected volumes. As a result of this splendid gift, Jessup prides itself upon the possession of a public library unequalled by that of any town of its size in the valley.

Mr. Law was a director of the Pennsylvania Oral School for the Deaf, by appointment of Governor Tener, and was a member of the advisory board of the Hahnemann Hospital Association. He was a member of the following: American Society of Mining Engineers; Engineers' Society of Northeastern Pennsylvania; International Society of Social Insurance, of which he was the American delegate-at-large, headquarters, Paris, France, this institution being for the purpose of discussing and devising ways and means for the protection and insurance of working men; the Scranton Club; the Green Ridge Club; the Country Club, all of Scranton; the Westmoreland Club, of Wilkes-Barre, and various other societies and clubs. In the Masonic order he held the thirty-second degree, Ancient and Accepted Scottish Rite. His only military service was for three years in an independent company of the National Guard of New York, the Buffalo City Guards. He was a member and trustee of the Green Ridge Presbyterian Church, and politically he was a strong supporter of the Republican party.

Mr. Law married, September 25, 1878, Eva G. Brenton, daughter of Joel Brenton, of Pittston, Pennsylvania, and three children were born to them, two of whom were: Frank E., a graduate of Yale University, living at the present time (1914); Grace B., married, September 4, 1908, Frank B. Rutter, who was vice-president of the Scranton Bolt and Nut Company, and both were instantly killed in a New Haven Railroad coach near New Haven, Connecticut, September 2, 1913, their bodies arriving in Scranton on the fifth anniversary of their wedding.

Mr. Law was a good citizen, and in the development of the anthracite industry in the valley none played a more prominent role. He learned the mining business from the beginning and no coal expert was more versed on mining. He also displayed remarkable ability and a vast capacity for governing men in the various positions to which he was called. He was, moreover, a Christian gentleman of high type, kind, considerate, benevolent and philanthropic.

---

### J. BENJAMIN DIMMICK

That the name of Dimmick, so closely related to many of most important financial institutions and commercial enterprises of Scranton, and with numerous educational and humanitarian projects in the vicinity, should be one of the most highly regarded and respected is only returning to an ancient and honorable lineage its just due. Although in the pages of history the name appears as Dymock, Dimmock and Dimick, modern usage sanctions only the spelling used in this chronicle, Dimmick. The Rev. Dr. Miller casts the following light upon the derivation of the surname: "The Dymocks come down from Tudor, Prince and Chief of the Welsh Marches, to David ap Madoc, some five hundred years, they being known in Wales as Dai (from Dy), Dai being in Welsh the diminutive of David. His successors were known as Daimoc, and Sir William Dymock, the sixth in descent from him, had the spelling in that form." Although in the days of George IV. the office of hereditary champion of England was abolished, from an early period it had been occupied by the English Dymock, acquired by the marriage of Sir John

Dymock, in the reign of Edward III., to the sole heirship of the Marmions, in whose family the position had previously been held.

It is Elder Thomas Dimmock that all bearers of the name in New England recognize as their common ancestor. He came from Barnstable, England, and was one of the incorporators of the town of that name in Massachusetts, in which state he held residence in 1635, although the exact date of his arrival is unknown. In the judicial, public, military and religious life of Barnstable he held positions of responsibility and honor. In religious convictions he was years in advance of his generation, a firm advocate of the tolerance he personally exercised. In the early settlements of the new country it was frequently to one man that the other citizens looked for guidance in all their public action and it was Elder Thomas Dimmock who served the village as leader in all matters of town government and improvement.

Timothy Dimmick, the fourth generation of the name in this country, married Ann, daughter of Joseph Bradford, a direct descendant of Governor Bradford, who came to America in the "Mayflower."

Alpheus Dimmick was the first of the family to make his permanent residence outside of the boundaries of New England. He attained eminence among the legal lights of New York state and represented Sullivan county in the state legislature. He was the father of Samuel Erskine Dimmick and grandfather of J. Benjamin Dimmick, whose careers are herein recorded.

Samuel Erskine Dimmick was born December 24, 1822. He was granted opportunities for a liberal education, and, improving these, began his honorable and eventful legal career with an excellent and comprehensive foundation for the more involved and more important legal questions he afterward learned. The office in which he was entered as a student at law was that of his cousin, William H. Dimmick, and it was here, in the years from 1844 to 1846, that he received much valuable and well-directed advice upon the legal lore that he was required to peruse, his relationship to Mr. Dimmick causing the latter to take special interest and concern in his welfare. On May 6, 1846, he was admitted to the Wayne county bar and subsequently formed a partnership with his cousin and former preceptor which continued until the latter's death in 1861. In addition to his large general practice he was retained as attorney for the Delaware and Hudson Canal Company, the county commissioners, and the Honesdale Bank, whose interests he guarded in a most satisfactory manner during the years of his connection in that capacity. In 1856 he was the choice of the Republican party of his district for the congressional election, his opponent being William H. Dimmick. The campaign was full of interest because of the peculiar circumstances of the case, the two contestants being blood relations, law partners, and the one having been the instructor of the other in the very matters upon which the qualifications of each for office were based. The district being strongly Democratic the public choice fell upon the older man, the Hon. W. H. Dimmick.

Samuel E. Dimmick was a loyal member of the Republican organization and a potent factor in the innermost councils of the party, to whose national convention he was a delegate in 1860, 1864 and 1868. In 1872 he was elected a delegate to the constitutional convention of Pennsylvania, a splendid tribute to his worth in council and intimate knowledge of the political and economic conditions of the country. His appointment by Governor Hartranft as attorney-general of the commonwealth was another proof of the confidence and reliance placed in his powers as a lawyer by those in authority above him. His usefulness in his new office was ended on October 11, 1875, by the grim hand of the Great Reaper removing him from a position in which he was only beginning to grasp the opportunity to exercise unrestrainedly the vast talents

with which he had been endowed and which had increased abundantly under his careful husbandry. The following is the official gubernatorial proclamation issued the day after Mr. Dimmick's death:

Executive Mansion,  
Harrisburg, October 12, 1875.

To the People of the Commonwealth of Pennsylvania:

It is with profound sorrow that I make official announcement of the death of Samuel E. Dimmick, which took place in this city last evening. The high tone of his public life, the talents and the private virtues of this distinguished man, will be his enduring memorial in the hearts of the people of Pennsylvania. Out of respect to his eminent services the several departments of government will be draped in mourning for the period of thirty days, and closed on Friday, October 13, when his funeral will take place.

J. T. HARTRANFT.

Probably there is no more sincere and better deserved memorial to the worth of any public official spread upon state or national records than that dedicated by the executive head of the State of Pennsylvania to Samuel E. Dimmick in his message of 1876:

In October last the mortal remains of the late Attorney-General Samuel E. Dimmick were reverently laid to rest in the little cemetery at Honesdale. Three years ago the character, integrity, and recognized legal abilities of this lamented man designated him for the important position he filled with so much dignity and honor, and the full measure of popularity he enjoyed at the time of his death showed how satisfactorily he discharged his responsible duties. Generous, manly, and upright in all the relations of life, and administering his high office with a stern and uncompromising fidelity to the interests of the state, the deceased attorney-general tempered his decisions with so much benevolence and courtesy that it is difficult to say whether as a man or official he was most beloved. Of delicate health and suffering from the affliction that resulted in his death, in response to what he believed a call of duty, Mr. Dimmick died while in attendance upon the Board of Pardons, where his merciful disposition and mature and correct judgment were invaluable helps in dispensing justice. With the public grief that deplores his loss, I may be permitted to mingle my private sorrow, for while the State mourns for a just and incorruptible officer, the administration has been deprived of a careful and wise counsellor, and the executive of a disinterested and devoted friend.

Samuel Dimmick married, January 28, 1855, Lucretia M. Benjamin, who died at Honesdale, Pennsylvania, February 14, 1880, daughter of Joseph Benjamin, Esquire, of New York.

J. Benjamin Dimmick, son of Samuel Erskine and Lucretia M. (Benjamin) Dimmick, was born in Honesdale, Pennsylvania, October 3, 1858. His opportunities for liberal education were well improved, his studies preparatory to college entrance being pursued at Adams Academy, Quincy, Massachusetts, and at Phillips Exeter Academy. In 1881 he matriculated at Yale College and was nearing the completion of his academic course, when, in the last term of his senior year, failing health necessitated the discontinuance of his studies. His vitality strengthened and his energies recruited by an extended European tour, he returned to Yale, subsequently receiving from that institution the degrees of Bachelor and Master of Arts. Upon his return home he decided upon the legal profession as the career best suited to his talents and liking, and after instruction in the office of William H. Dimmick was admitted to the bar of Wayne county in 1882. His active practice began in 1883, in which year he located in Scranton and formed a partnership with his cousin, Edward C. Dimmick, an association that continued for but a short time before continued ill-health compelled him to withdraw from the firm and seek a change of air and climate. He again went abroad, spending most of his time in Switzerland, until, fully recovered, he returned to Scranton. Here he became interested in financial and industrial affairs rather than in the practice of his pro-

fession and has become a notable figure in many of the leading institutions of this kind in the city. He is president of the Lackawanna Trust and Safe Deposit Company, and of the Scranton Lace Curtain Company, vice-president of the First National Bank and in the South Side Bank he holds the office of director.

Mr. Dimmick has always been a close student of political economy and has a broad and comprehensive knowledge of national, state and municipal needs and conditions. As a resident of the City of Scranton he has taken especial interest in its civic progress and betterment, and in 1906, in response to an urgent request of the citizens of the city, he permitted his name to be used as a candidate for the office of the city's chief executive. His election and induction into office was immediately followed by unusual activity and progress along all municipal lines, health conservation, recreation and improved highways receiving especial attention. While acting as mayor his name was first mentioned as a candidate for the office of United States senator, but it was not until the year 1914 that he became an active candidate for this important office. Although defeated by the powerful influences arrayed against him the strong personality of the man was manifest in the support given him throughout the state. As is natural with one of his wide education he realizes the value and companionship of good books to the individual and is a firm friend and supporter of the Scranton Public Library. His kind, benevolent, and warmly sympathetic nature is testified by his interest in the Scranton Society for the Prevention and Cure of Consumption, and in the Pennsylvania Oral School for the Deaf Mutes, in both of which he is a trustee. In the leading literary and social organizations of the city he is a prominent member, belonging to the University Club, the Yale Club, of New York City, and the Scranton and Country clubs, of Scranton.

Mr. Dimmick married, November 9, 1881, Louisa H. Hunt, daughter of Dr. E. K. and Mary (Crosby) Hunt, of Hartford, Connecticut. Children: Jeannette Hunt, born July 28, 1883; Lucretia Benjamin, born May 20, 1889, died January 4, 1893; Mary Crosby, born February 10, 1894.

---

#### COLONEL LOUIS ARTHUR WATRES

While the records of the past are practically bare of reference to the Watres family of which Colonel Louis A. Watres is a member, the generations of the name to come will seek no fairer heritage than the honor descending to them found from the part played in all the different paths of life by those with whom this narrative deals. Patriotism in time of national need, activity in the aid of all humanitarian enterprises, unselfish devotion to public duty, and eminence in political life, are a few of the glorious attributes which make the name of Watres one of the proudest of the present day.

Lewis S. Watres, father of Colonel Louis A. Watres, was born in Phoenixville, Pennsylvania, in 1808, died August 1, 1882. When he was twenty-seven years of age he became a resident of the Lackawanna Valley, in whose material, intellectual and moral progress he was ever after a prominent factor. Having purchased 400 acres of land in Mount Vernon, now Winton, he first turned his attention to its clearing and to disposing of the lumber secured through this process. Besides being the proprietor of many of the business enterprises of the vicinity, he opened the first coal mine in the valley below Carbondale. His activity in the development of that section of the valley made him widely acquainted throughout the region, and for several years he served as justice of the peace of Blakeley township. After coming to Scranton, his participation in political matters was confined to holding the office of alderman from



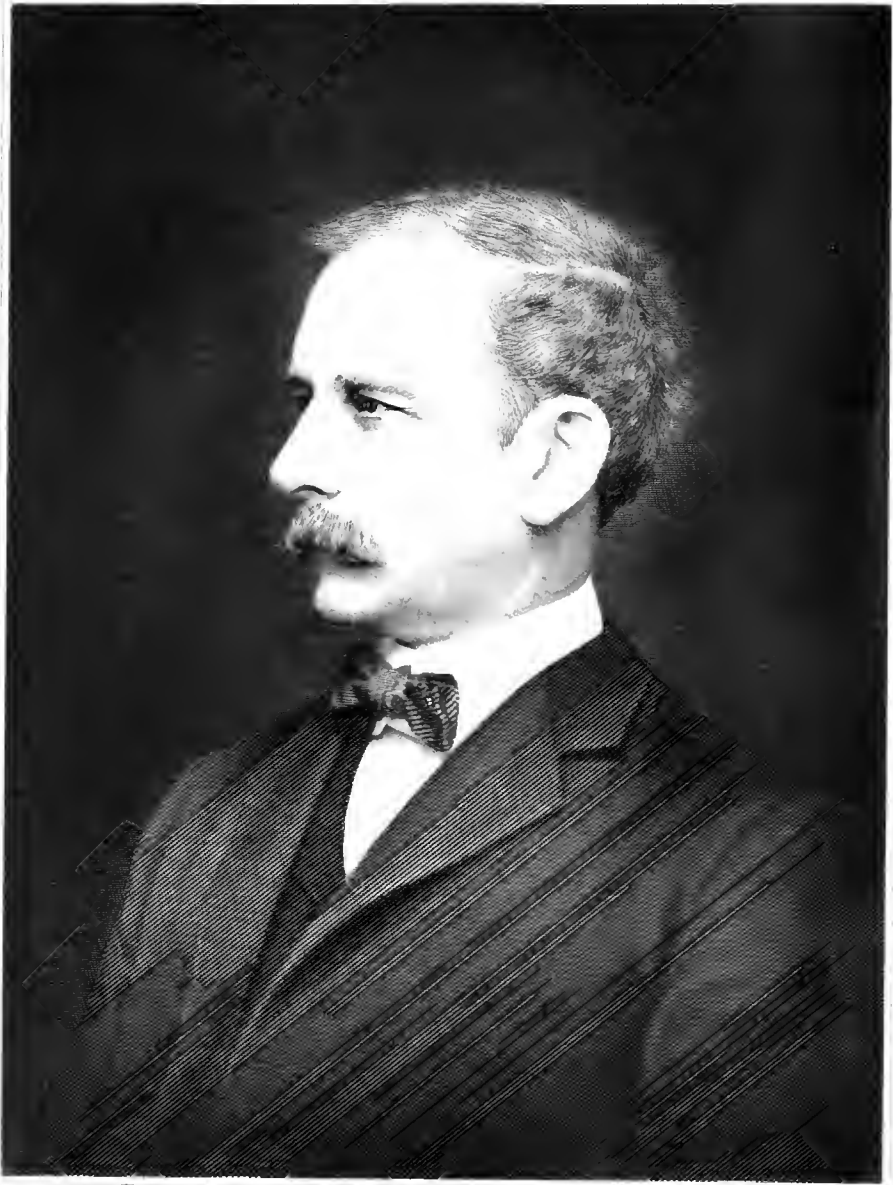

Louis A. Votaw



the ninth ward for seventeen years, from the time of his arrival in the city in 1865 until his death.

Although at the outbreak of the Civil War physical weakness prevented him from going to the front, his patriotic sympathy for the Union cause led him to recruit a company which was mustered in at Harrisburg and assigned as Company H, Fifty-second Pennsylvania Infantry. He later formed another company, which was attached as Company I, Fifty-sixth Regiment, and by his successful efforts in raising equipment and money, and by sturdy defense of the war policy of the administration, was quite as useful to the cause of the North as though he had enlisted. Hearty sympathizers at home were of great value at the time, the complaints of the stay-at-homes often proving as troublesome to the officials in charge as the attacks of the opposing army. Mr. Watres was a communicant of the Presbyterian church and was the donor of the first church of any denomination erected in the valley, Pecktown Presbyterian Church. His strong and uplifting influence was felt by all of his associates, his sympathetic and considerate character making him a figure admired and loved. Contact with him lent a freshness to daily life that, lingering, abided long.

Mr. Watres married Harriet G. Hollister, a poetess, possessing unusual talent, whose poems made a peculiar appeal to popular tastes and were widely read. Among her poems was "Send Them Home Tenderly," which was set to music and became a popular camp fire song. All were printed over the pseudonym "Stella of Lackawanna," and some, since her death, have been published in a volume entitled "Cobwebs."

Colonel Louis Arthur Watres, son of Lewis S. and Harriet G. (Hollister) Watres, was born in (now) Winton, Lackawanna county, Pennsylvania, April 21, 1851. His education, as far as school training was concerned, was curtailed by the necessity of earning his own livelihood. He was employed in various ways, utilizing all his spare time for study and for attendance at night school. While still a young man, he secured a position as teller of the Merchants' and Mechanics' Bank, of Scranton, later becoming cashier of the County Savings Bank and Trust Company, of Scranton. His youthful ambition, a desire increasing with the passing years, had been to qualify himself for admission to the bar. Assiduous study and increasing application to the mastery of the principles of the law enabled him to reach the goal of his striving, and in 1878 he successfully passed the examination securing him admission to the Lackawanna county bar. Having thus gained recognition as the possessor of the necessary knowledge for the practice of the law, he immediately set himself to the task of proving himself worthy of his chosen profession. He advanced steadily in his profession, and in due course of time his ability and dependency as an attorney was proven and testified to by a large and thoroughly representative clientage, and he stands among the foremost lawyers of the state. For a dozen years, however, Colonel Watres, by reason of his other interests, has been obliged to withdraw from the active practice of the law.

The experience that he gained in business before his adoption of the law has been invaluable to him as adviser, in private, and as counsel, in professional relations, with various business enterprises in Scranton. His keen judgment and discernment make him a most able and successful financier, and his services are eagerly sought. He is a stockholder and director of many corporations in the Scranton and Lackawanna Valley. He was one of the organizers of the Scranton Passenger Railway Company, of which he became president. He is president also of the County Savings Bank, of the Spring Brook Water Supply Company, of the Mansfield Water Company, of the Scranton Trust

Company and of the Boulevard Company, and is a trustee of the American Surety Company of New York. As the executive head of these various corporations he has added to his legal achievements those of a financier of the highest order, all of his concerns having a firm and sound basis and enjoying the confidence of all investors. So well known is his reputation for the strictest sort of business dealing and so free his record from the slightest taint of suspicion of irregular transactions, that his name upon the directorate of a concern is proof positive of its reliability.

Not too deeply engrossed in his professional and practical pursuits to recognize his public duties, Colonel Watres has been a notable figure in the political events of the day, his rise in that field being on the same broad scale as his advance in the other walks of life to which he has been called. Well versed in all political issues, and giving support and allegiance to the Republican party, as the representative of that party he attained prominence that has brought fame to him and honor to the Republican organization. In 1881 he was elected county solicitor of Lackawanna county and retained that position until 1890. From 1883 to 1891 he was state senator, and in the senate, the highest deliberative forum of the state, was a commanding power, proposing and aiding in the enactment of many of the most important measures before that body during his years of service. Here his training as a lawyer stood him in excellent stead, his forensic talents often making him the choice of his party for the defence of legislation requiring exact and lucid explanation and forceful and convincing support. Called from his senatorial service to the duties of lieutenant-governor, he fully justified in this lofty office the choice of the people by the competent manner in which he bore its weighty responsibilities. Proof of his place in the estimation of the voters of the state is given in the figures of the election, his plurality being 22,365, while that of Mr. Pattison, candidate for governor on the opposing ticket, Democratic, was 17,000. Among the more important duties devolving upon his office were those of president of the senate and president of the board of pardons. In the former he controlled legislation with a masterly hand, causing the strictest decorum and dignity to prevail during the consideration of any measure, and in the latter tempering the severity of the statutes with a mercy as wise as it was kind, yet observing the strictest justice throughout. By an act of the state assembly he was appointed commissioner from Pennsylvania to the World's Columbian Exposition at Chicago, and subsequently he was elected vice-president of the board. In August, 1891, he was chosen chairman of the Republican state committee. For thirty years Colonel Watres has been a vital force in molding the affairs of the Republican party and in safeguarding and directing its interests in Pennsylvania. He has always been an exponent of the most progressive movements of the party, an advocate of the best and purest in politics.

The same open plan of procedure has been followed by Colonel Watres in his public life as in all his other dealings, and his political record is an open book, each page free for the perusal of any one who cares to read. He has been actively associated with the National Guard of the State for many years, and during his service in that body he gained the rank of colonel. As a state official he did much toward promoting the efficiency of, and toward creating interest in, that excellent organization, whose importance and usefulness cannot be over-estimated. He was in continuous service from 1877 to 1891, and again from August, 1898, to August, 1904, seven years of this time as captain of Company A, Thirteenth Regiment. From 1887 to 1891 he was a member of the governor's staff, as inspector of rifle practice, with the rank of colonel, and subsequently, during the period of the Spanish War, became colonel of

the Eleventh Regiment Provisional Guard. On the return of the Thirteenth Regiment from the field and after its muster out of service, he became colonel of the Thirteenth Regiment National Guard of Pennsylvania. At the organization of the National Guard Association of Pennsylvania, he became its first president, holding that office for two years. Colonel Watres is a member and past master of Peter Williamson Lodge, No. 323, F. and A. M.; elected junior grand warden in 1909, and at the present time (1914) is right worshipful deputy grand master of the Grand Lodge of Masons in Pennsylvania.

Colonel Watres married, in 1874, Effie Hawley, and of this union three sons were born: Harold, died September 16, 1905, aged twenty-six years; Lawrence and Rebyburn.

In the course of his unusually useful life, Colonel Watres has engaged in a variety of pursuits that proclaim him the gifted and talented man of parts. Perhaps his greatest achievements have been as a public servant, yet none of the many phases of his life's work can be disregarded. His assumption and discharge of the duties of good citizenship have been admirable and thorough, an honor to himself and the state he served. The influence of his gentle character and of his upright example, so worthy and yet so difficult of emulation, will live long after the body of Colonel Louis Arthur Watres has returned to its natural elements and his spirit to everlasting life.

---

#### LUCIUS C. KENNEDY, M. D.

John Kennedy, who came from Bangor, county Down, Ireland, in 1763, and settled in Kingston, New York, is the first of the family of whom we have absolute knowledge. He was born April 24, 1739. Owing to his being of the Scotch Presbyterian faith and having lived but a few miles from the Kennedys of Cultra, some have thought him related to that ancient family, who were doubtless connected with the Earls of Casselis in Scotland, in which the name John was given to the oldest son for seven or eight generations. Be that as it may, family tradition assures us that John Kennedy, the emigrant, was a man of ability, clear-headed and kind-hearted. Like the majority of those who came early to this country he had a trade, being a tailor, an occupation he pursued after coming to America. In Kingston, New York, he married Mrs. Josiah Van Fleet, whose maiden name was Armstrong. There were several children born of her first marriage who settled in Galena, Ohio. The time and place of her death is unknown, but her husband long survived her. He settled in the Wyoming Valley in 1780. He died August 20, 1809, aged seventy years, and was buried in Plains township cemetery, Luzerne county, Pennsylvania. To John Kennedy and his wife were born five children, four of whom married into families who were in the Wyoming Valley previous to the massacre, several members of them being in that memorable conflict. Catherine, married Cornelius Courtright; Elizabeth, married Henry Stark; John, married Sallie Abbott; James, married Nancy Armstrong; Thomas of whom further.

(II) Thomas Kennedy, son of John Kennedy, married, in 1801, Elizabeth Schofield, born April 15, 1784, in Kingston, New York, a gentle little woman, much beloved by her children, grandchildren and great-grandchildren. She was descended from the Pinckneys of South Carolina, and in many respects was a remarkable woman. Left a widow at twenty-five years of age with five little children, she managed her affairs in such a manner that they grew to manhood and womanhood, a credit to their mother's training. She died April 12, 1880, at the home of her son, James Schofield Kennedy, where she had long resided. The children of Thomas and Elizabeth (Schofield) Kennedy

were: John, married Polly Campbell; Sarah, married William H. Sherman; Polly, married Crandall Wilcox; Henry, married Julia Mills; James Schofield, of whom further.

(III) James Schofield Kennedy, son of Thomas Kennedy, was born January 28, 1808. Early in life he learned the carpenter trade, and was a contractor for several years. He afterward purchased a farm in Lackawanna township, now Taylor, and in connection with his farm did an extensive business in grain and flour, selling to the merchants all along the Valley from Pittston to Carbondale. He was justice of the peace from 1843 to 1845. He sold his farm in Lackawanna just before coal was discovered, and moved to Hyde Park. In 1850 he opened a store in Providence in the old Arcade Building on North Main avenue, long occupied as an office by the Providence Water Company. Later he carried on business on Providence Square, being a partner in the firm of Kennedy & Osterhout. In 1854-56 he had a contract to build a section of the Delaware, Lackawanna and Western Railroad, then being constructed between New York and Scranton. He was active in public affairs, serving on the borough council and also on the school board. In 1865 he sold out his interest in the store to his son, William DeWitt Kennedy, and retired from active business. He died March 7, 1885.

He married, September 26, 1833, Pauline Jayne, born December 13, 1815, died May 16, 1897, daughter of Samuel and Elsie (Stephens) Jayne. The Jaynes were descended from Henry de Jeanne, a professor in Oxford University. His son, William, a student in the University, afterward married in England, name of wife not known. In 1652 he was chaplain in Cromwell's army. In 1670, his wife having died and the cause of Cromwell being no longer popular, he emigrated to America, settling in New Haven, Connecticut, leaving three grown sons in England. At that time he took the name of Jayne. In 1675 he married Annie Beigs, and soon after with thirteen or fifteen others crossed over to Long Island, purchased land of the Indians, and settled the town of Brookhaven. The graves of the first settlers are to be found there, and the old farm is still owned by one of the family. William and Annie (Beigs) Jayne were the parents of nine children. Their oldest son, William Jayne, married Elizabeth Woodhull, whose oldest son, William Jayne, married Tabitha Norton; they were the parents of Rev. David Jayne, born May 14, 1751, died March 9, 1837, who served in the war of the Revolution, and was afterward given a section of "Soldier Land" on Lake Cayuga. The wife of the Rev. David Jayne was Elizabeth DeWitt, born May 3, 1754, died February 15, 1825, whose father, Daniel DeWitt, also served in the Revolution. The son of the Rev. David Jayne was Samuel Jayne, born February 4, 1779, married Elsie Stephens, May 2, 1796, died at Factoryville, Pennsylvania, August 12, 1860. The grandfather of Elsie (Stephens) Jayne was Eliphalet Stephens. He was a native of Massachusetts, although his military service is credited to New York, from which he enlisted, then his home. After the war he settled in the Wyoming Valley, where he was a man of substance and importance. In the court house in Wilkes-Barre, Pennsylvania, (book of deeds No. 3, page 46) it is recorded, "James Finn to Eliphalet Stephens (Stevens), land in Pittston township, on the Lackawanna river, and one-half interest in a Saw Mill May 25, 1795; consideration 600 pounds sterling." Other deeds are recorded showing him to have been a large land owner. Eliphalet Stephens was born in Massachusetts, in 1731, and died in Nicholson, Pennsylvania, in August, 1814. Early in life he removed to Connecticut, from thence to Dutchess county, New York. On July 31, 1775, he enlisted in Third Regiment New York Continental Line, Captain Jacob S. Bruyn's company, under Colonel

Clinton. He is described as a man five feet seven inches in height, light hair, fair complexion, age 44, occupation blacksmith. He married, in 1751, Elsie Holloway, who died at Nicholson, Pennsylvania, in April, 1820. Eliphalet Stephens had a son, Ebenezer Stephens, born in Goshen, New York, May 12, 1759. He was also in the Revolution, entering at the age of seventeen, and served during the entire seven years. He was a pensioner until his death, in Nicholson, Pennsylvania, November 15, 1839. He married, at Goshen, New York, May 16, 1780, Rachel Squirrel, born at Goshen, in 1758, died at Nicholson, Pennsylvania, August 2, 1848. After the death of her husband, his widow, Rachel (Squirrel) Stephens, received the pension during her life time. They were the parents of Elsie Stephens, who married Samuel Jayne; she was born May 15, 1780, died November 10, 1860.

James Schofield and Pauline (Jayne) Kennedy were the parents of thirteen children: Mary L., married James Hicks; Catherine H., married Rev. Lyman C. Floyd; John Jayne, married Mehitable Griffin, he died July 21, 1897; Sarah E., married (first) Isaac H. Heermans, (second) A. B. Crandall, William De Witt, of whom further; James Thomas, married Angeline Carey; Julia A., married Rev. George Forsyth; Charles Henry, died September 11, 1806, unmarried; Nancy Elizabeth, died young; Adelaide May, married David F. Shook; Frank E., married Sylvia Davis; Clara Augusta, married George R. Clark, she died October 5, 1895; Helen, married William H. Stevens.

(IV) William De Witt Kennedy, son of James Schofield and Pauline (Jayne) Kennedy, was born in Lackawanna township, Luzerne county, Pennsylvania, September 24, 1842. He was educated in the public schools of Scranton, and Eastman's Business College, Poughkeepsie, New York. Mr. Kennedy was a director of the Scranton Savings Bank until it was merged with the Dime Bank, now the Scranton Savings & Dime Bank, and otherwise prominent in the business life of Scranton, Pennsylvania. He was for many years a trustee in the Providence Presbyterian Church, and now serves in the same capacity in the Green Ridge Presbyterian Church. He is a member of the Pennsylvania Society of the Sons of the Revolution on the records of Eliphalet and Ebenezer Stephens and Daniel De Witt. He belongs to the Country Club and the New England Society. He served during the war of the Rebellion in the Thirtieth Pennsylvania Reserves, during the invasion of Pennsylvania by the Southern army under General Robert E. Lee. During the last year of the war he was quartermaster's clerk in the Fiftieth New York Regiment (Engineer Corps). He is a member of Ezra Griffith Post, No. 139, G. A. R.

Mr. Kennedy married, February 11, 1868, Amelia Maria Carter, born April 29, 1844, daughter of Pulaski Carter (see Carter). Through her father, Mrs. Kennedy descends from sterling New England ancestry, notable for patriotism and high public spirit. Mrs. Kennedy graduated from East Greenwich Seminary, East Greenwich, Rhode Island, in 1865. She has been for many years interested in the philanthropic movements of the city, particularly in connection with the Home for the Friendless. She has been on its board of managers for twenty-three years, and has held many offices from secretary to president. For some years she has been vice-president of the Young Woman's Christian Association. For over fifty years she was an active member of the Presbyterian church, for the first thirty years of this period affiliating with the church of that denomination in the Providence section, but since 1893 has been identified with the Presbyterian church at Green Ridge.

Mr. and Mrs. William De Witt Kennedy are the parents of three sons and one daughter: 1. William Pulaski, born October 30, 1869; graduated from the Scranton (Pennsylvania) High School, class of 1889; he was for fifteen years teller of the People's National Bank of Scranton, Pennsylvania, now

cashier of the Tribune Republican; he married December 11, 1895, Georgina, daughter of George R. and Harriet (Westbrook) Kittle; she was graduated from the same high school class as her husband; they are the parents of two children: Olive Ingalls, born December 15, 1896, graduated at Scranton High School, June 19, 1914, and Hilda De Witt, born June 14, 1901. 2. Dr. Lucius Carter, of whom further. 3. Katharine May, born November 11, 1875; graduated from the School of Lackawanna, class of 1895, afterward attending Miss Baldwin's School for Young Ladies at Bryn Mawr, Pennsylvania; she married, June 25, 1902, Dr. William Anthony Sherman, son of Albert K. and Mary (Barker) Sherman, of Newport, Rhode Island, descended from Philip Sherman, one of the eighteen persons who purchased the Island of Rhode Island from the Indians; Dr. Sherman was graduated from Harvard University in 1899, and from the medical department in 1902; Dr. William A. and Katharine May Sherman are the parents of two children: William Albert, born May 12, 1903; Charlotte Carter, born June 20, 1911. 4. Harold Sherman, born November 28, 1884; graduated from Blair (New Jersey) Academy in 1905; later entered the law department of the University of Pennsylvania, class of 1910, admitted to bar of Lackawanna county, October, 1910, and is practicing his profession in Scranton.

(V) Dr. Lucius Carter Kennedy, second son of William De Witt and Amelia Maria (Carter) Kennedy, was born in Scranton, Pennsylvania, September 8, 1872. He is a graduate of Scranton High School, class of 1889, School of the Lackawanna, 1891, Princeton University, A. B., class of 1895, University of Pennsylvania Medical Department, M. D., 1898. After graduation Dr. Kennedy spent eighteen months as a member of the medical staff of Moses Taylor Hospital, Scranton, then pursued a post-graduate course at the University of Vienna, Austria. He then returned to Scranton and in 1900 began the active practice of his profession in this city where he is thoroughly established in public regard as a physician of learning, skill and honor. He is chief of the staff of one of the departments of the State Hospital at Scranton and ministers to a large private clientele. In 1907 Dr. Kennedy was president of the Lackawanna County Medical Society; is a member of the American and Pennsylvania State Medical associations and interested in the work of all. His clubs are the Scranton, Country, and Green Ridge. In political faith he is a Republican, and in religious association a member of Green Ridge Presbyterian Church.

Dr. Kennedy married, April 14, 1914, Margaret, daughter of William Robertson, of Branford, Canada. His offices are at No. 1030 Green Ridge street, Scranton.

---

#### PULASKI CARTER

Pulaski Carter, deceased, was one of the strongest characters and most useful men of his day. He inherited in marked degree the sterling traits of his New England ancestry, and his name was ever a synonym for the strictest integrity and most uncompromising devotion to principle. His family has been from the beginning of its history in America notable for patriotism and public spirit of the highest quality.

(I) The first Carters of whom we have authentic record in this country are Thomas Carter, blacksmith, and Mary his wife. Their names appear upon the church record in Charlestown, Massachusetts, in 1636. They were married in England. Their children were: Thomas, Joseph, Samuel, John, Mary, Hannah. The will of Thomas Carter Sr. was recorded in 1652. He died possessed of considerable landed property. His wife Mary died in 1664, and her death is thus recorded: "Mary Carter, mother of the Carters in town."



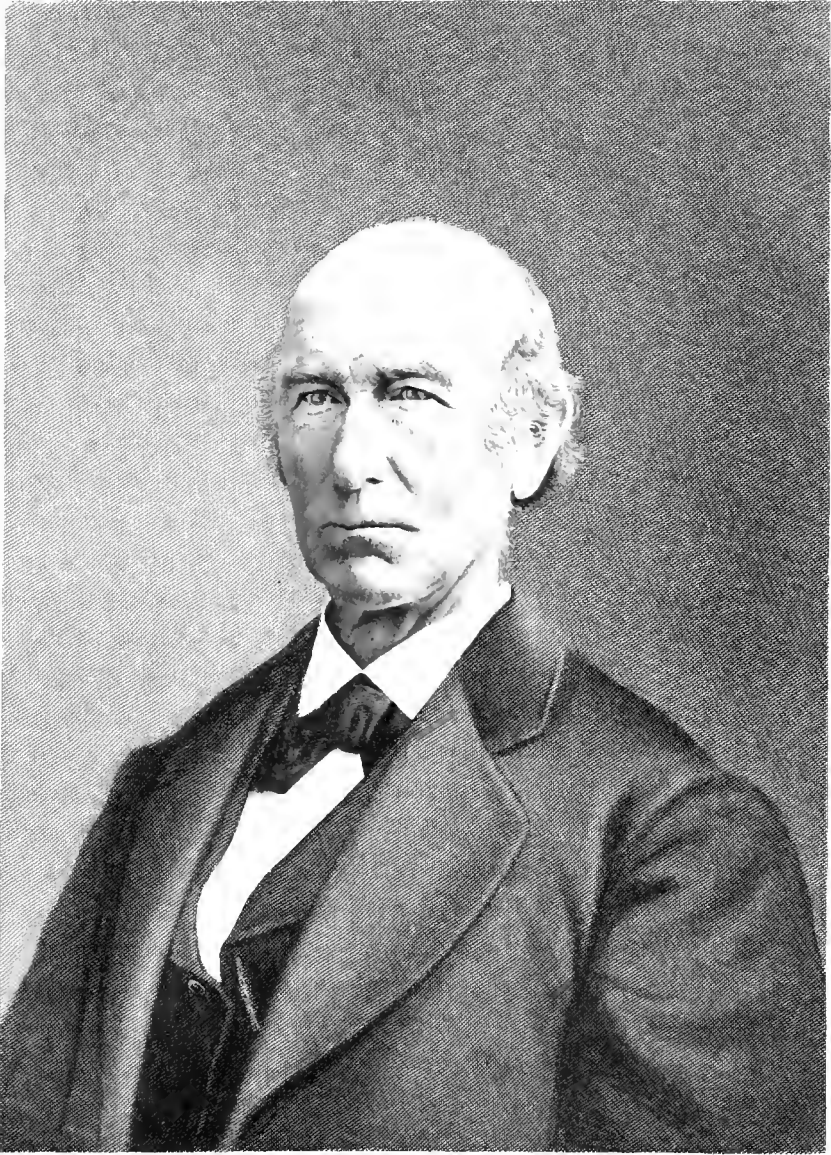

Pulaski, Carter



(II) Joseph Carter, second son of Thomas Carter, was a currier. He was first of Charlestown, but later lived on the old Billerica road, Woburn, Massachusetts, with his son, Joseph Jr. He died December 30, 1670.

(III) Joseph (2) Carter, son of Joseph (1) Carter, lived in Woburn, Massachusetts, married Bethia Pearson, and at his demise in 1692 left three sons and three daughters.

(IV) John Carter, son of Joseph (2) Carter, was born February 26, 1676, moved to Canterbury, Connecticut, with his wife Mary about 1706.

(V) John (2) Carter, son of John (1) Carter, was born in Canterbury, February 24, 1709. He married Deborah Bundy, and they had nine children.

(VI) Joseph (3) Carter, son of John (2) Carter, was born July 18, 1736. He married Patience Pellet, October 3, 1762. He served as quartermaster in the Revolution, and died August 15, 1796.

(VII) Phineas Carter, son of Joseph (3) and Patience (Pellet) Carter, was born November 23, 1766. He was a landed proprietor of Westminister, Connecticut, and a man of strong character and strict integrity, upright to the point of austerity; a devout Christian of the Congregational faith, rigid in exacting observance of religious forms and ceremonies; and strict in his family discipline. He married Cynthia Butts, a woman of gentle nature and lovable traits of character. She was born March 16, 1773, and came of a family of prominence in the public and private colonial life of New England. Her father, Deacon Stephen Butts, of Westminister, Connecticut, born June 15, 1749, was the son of Joseph Butts, born March 17, 1711. The father of Joseph Butts was Samuel Butts, who married Sarah Maxfield, July 22, 1701. Samuel Butts was a man of distinction in many respects, and the record of his official services is preserved in the archives of the state of Connecticut. He was elected thirteen times to the colonial assembly from Canterbury, Connecticut, during the period between 1715 and 1729, and was otherwise conspicuous in the community. His father was Richard Butts. He married Deliverance Hoppin, daughter of Thomas and Elizabeth Hoppin, who came from England to Dorchester, Massachusetts, in 1636. Phineas Carter died November 8, 1840, long surviving his wife, who died March 19, 1814.

(VIII) Pulaski Carter, son of Phineas and Cynthia (Butts) Carter, was born in Westminister, Windham county, Connecticut, June 23, 1813, was only nine months old when his mother died. His father desired for him the career of a physician, and was much disappointed when the young man's inclination turned toward mechanics, and he went to Brooklyn, Connecticut, where he learned blacksmithing. On completing his apprenticeship he went to Winsted, Connecticut, where he entered the shop of Captain Wheelock Thayer, and there gained a thorough practical knowledge of scythe-making. He first visited Pennsylvania in 1840, at which time he went to Honesdale and several other localities, finally deciding to locate in Providence (now the first ward of Scranton). In 1841 he returned there and engaged in scythe-making. In June of the following year, in company with Jerrison White, he purchased the Sager & White Axe factory, and began the manufacture of axes as well as scythes—the first factory of the kind in the state. He shortly afterward acquired his partner's interest, and in 1843 associated with himself a boyhood friend, Henry Harrison Crane. Mr. Crane subsequently disposed of his interest in the business, but still remained in the works. Mr. Carter then took as a partner Artemus Miller, but this partnership was soon dissolved, Mr. Carter assuming the entire ownership and management of the business.

Meanwhile Mr. Carter had laid the foundations of the enterprise which came to be known as "The Capouse Works" (so named after the old Indian chief of the Monseys, from whom also the Capouse Meadows received their name), purchasing a thirty-acre tract of land from Henry Heermans, and

erecting thereon shops, etc., sufficient to commence business, and here was made the wide reputation of the "Carter axes" which were for many years unrivaled. In 1864 the factory burned down, entailing a most serious loss, the insurance being wholly inadequate to defray the cost of rebuilding. In this hour of his great disaster, Mr. Carter was proffered abundance of financial aid by persons who appreciated his enterprise and had implicit confidence in his ability and integrity. These evidences of confidence he gratefully declined, and he built and equipped an entirely new and improved factory which for many years was one of the important industries of the valley, and this was accomplished with the preservation of that personal independence and self-reliance of which he was so justly proud. His business career ended only with his death, and he maintained to the last his deep interest and pride in the great enterprise which was the creature of his own brain and hands.

In his relations to the community at large, Mr. Carter bore himself with the same dignity and conscientiousness that characterized the conduct of his business affairs. Whatever claimed his attention received from him the deepest interest and best efforts of which his heart and mind were capable. The parental training had indoctrinated him with the loftiest conceptions of an all-comprehending morality, and when he first left the paternal roof he came under influences which intensified his thought along the same lines. In the first days of his blacksmith apprenticeship, youth as he was, he became acquainted with the philosophy of the famous Concord and Brook Farm School. This was brought about through the Unitarian minister at Brooklyn, Connecticut, the Rev. Samuel J. May (intimate friend of William Lloyd Garrison, Wendell Phillips and Ralph Waldo Emerson), who allowed him free access to his library and aided him in his reading. So impressed was the young man with the field of thought to which he was thus introduced that in after years he was able to repeat from memory entire pages from the volumes which he read in those early days, and the sentiments which he imbibed colored his whole life. A signal exemplification of this was seen in 1847, when the free school idea was first broached. With a heart inspired with the most liberal New England ideas as to education, Mr. Carter, then a young man of thirty-four, threw himself into the struggle with all the intensity of his nature, and traversed the valley back and forth, preaching the gospel of free schools. An earnest and forceful speaker, he produced a deep impression. Nor was he content with this effort; he followed his appeals with labors of organization, and when the question came before the people he had his followers so well in hand that a decisive victory was won at the polls. Thus was the free school planted in Providence, at a time when Scranton was little more than a name upon the map. Mr. Carter followed his success with yet more practical effort, donating the land on which was erected the first free school building in the place, and he maintained an undiminished interest in educational affairs throughout his life. In 1857 the first graded schoolhouse was built, and in the public celebration of that event Mr. Carter was awarded high praise as the corner-stone upon which the free school cause had been founded. For twenty-eight years he served as director and treasurer of the Providence school board, and this fact speaks yet more eloquently of his heartfelt interest in the cause which he had so long and faithfully championed, for naturally of a retiring disposition and averse to public prominence, he had steadfastly declined the mayoralty and other important positions which he was solicited to accept. His considerate humanitarianism found eloquent expression in his efforts in behalf of temperance. His voice was ever heard in denunciation of the evils of the liquor traffic, persistently opposed the granting of license, and the saloon keepers greatly dreaded and feared him. But he went far in advance of the great mass of temperance agitators.

He gave his personal effort to the reclamation of the drunkard, and rescued many a one from a life of poverty and shame, and aided him to an honest and happy establishment in life.

Mr. Carter married (first) August 5, 1839, Susan S. Spaulding, of Abington, Connecticut, about the time he had completed his trade, and two years before he located in Providence. The year of his coming (1841) a child was born to them, but death claimed the young mother a month later, and in the following summer the little one also died. Mr. Carter married (second) August 7, 1843, Olive Ingalls, of Canterbury, Connecticut, a double cousin of his first wife. Her ancestry is traced to the early colonial period, her emigrant ancestor being Edmund Ingalls, son of Robert Ingalls, and grandson of Henry Skirbeck. Edmund Ingalls was a native of England, born in Lincolnshire in 1598. He came to Salem, Massachusetts, in 1628, with Governor Endicott's company. In 1629, with his brother Francis and four others, he founded the settlement at Lynn, Massachusetts. In 1648, while traveling on horseback to Boston, he came to his death by drowning in the Saugus river, the accident resulting from a defective bridge. His son Henry, born in 1627, died 1719, was a landowner in Ipswich, and was one of the first settlers of Andover, where he bought land from the Indians, making payment with clothing and trinkets. He was a wealthy man for the times, and took a leading part in town affairs. He married Mary Osgood, July 6, 1653, a daughter of John Osgood, who was the first representative to the general court from Andover, in 1651. It is the first record of a marriage in Andover. The ceremony was performed by Rev. Simon Bradstreet, following the Puritan doctrine and belief in marriage as a civil compact. Their son Henry, like his father, was prominent in colonial affairs. Joseph Ingalls, son of Henry Ingalls Jr., was born in Andover in 1697, and married Phoebe, daughter of John Farnham. Their son, Joseph Jr., born 1723, removed to Pomfret, Connecticut; he married Sarah Abbott, daughter of Paul and Elizabeth (Gray) Abbott, and died in 1790. Their son, Peter Ingalls, born 1752, died 1783, served in the war of the Revolution. He married Sarah Ashley, and the homestead built by him is still standing and remains in the ownership of descended relatives of his daughter, at Elliott, Connecticut. His son Marvin, who served in the war of 1812, born 1789, married Amelia Spaulding, who came from an old colonial family. Her father, James Spaulding, lived at Windham, and was one of Putnam's militia that marched to Lexington, and was also in the company that marched to Cambridge in the early period of the Revolutionary war, and his name appears on the pension roll of Revolutionary soldiers in 1815. He was descended from Edward Spaulding, whose family records go back to an early period of English history, and numbered at least one eminent divine among its members. Edward Spaulding settled in Braintree, Massachusetts, between 1630 and 1633, where he was prominent in town affairs, being a selectman and also for many years a surveyor of highways. He was a landed proprietor and left a large estate. The crest of the Spaulding family bears the motto *Hinc mihi salus*. Pulaski and Olive (Ingalls) Carter had three children: Amelia Maria, Pulaski Pliny, Marvin Phineas, all of whom further.

(IX) Amelia Maria Carter, first child of Pulaski and Olive (Ingalls) Carter, was born April 20, 1844. She married William DeWitt Kennedy February 11, 1868. Mr. Kennedy is of Scotch-Irish and French-Dutch ancestry. One of his ancestors of his mother's side was chaplain in Cromwell's army. His father was James Schofield Kennedy, who was the son of Thomas and Elizabeth (Schofield) Kennedy. The father of Thomas Kennedy was John Kennedy, whose family was of Scotch-Irish lineage. He was born April 24, 1739, and came to America from Bangor, Ireland, in 1763. He was

of the Scotch Presbyterian faith. He settled in Kingston, New York, and later married Mrs. Josiah (Armstrong) Van Fleet, widow. Soon after his marriage in 1780 they moved to Wyoming Valley. His mother was Pauline Jayne (the original form of the family name being "De Jeanne") the daughter of Samuel and Elsie Stephens Jayne, the latter being the daughter of the Rev. David Jayne, whose wife was Elizabeth DeWitt, a cousin of the wife of General James Clinton, of Revolutionary fame. The grandfather of Mrs. Kennedy, the Rev. David Jayne, served in a New Jersey regiment in the Revolution, and took up a large and valuable section of "soldier land" near Lake Cayuga, New York. Her great-grandfather, Eliphalet Stephens, and his grandfather, Ebenezer Stephens, were both in the Revolutionary army, and remained in service the entire seven years of the war. Ebenezer Stephens drew a pension at Wilkes-Barre as long as he lived.

(IX) Pulaski Pliny Carter, second child of Pulaski and Olive (Ingalls) Carter, was born June 6, 1849. He was educated at East Greenwich, Rhode Island, and at Fort Edward Institute. He is largely interested in real estate enterprises, and is owner of the large office building at the corner of Adams avenue and Linden street, Scranton. He married, June 6, 1882, Venitia White, born February 11, 1862, daughter of Joseph M. and Phebe A. (Cole) White, daughter of Immanuel Cole, the latter of excellent English descent. Joseph White was the son of Ephraim White, of White's Mills, near Honesdale, who was the son of Ezekiel (3) White, the son of Ezekiel (2) and Sarah (Vinton) White. He was the son of Ezekiel (1) White, who married Abigail Blanchard. Ezekiel (1) White was the son of Captain Ebenezer White, whose wife was Hannah Phillips. Captain Ebenezer White was born in Weymouth, Massachusetts, and was a son of Thomas White (wife's name unknown) who was admitted a freeman in Massachusetts colony, 1635-36. Place of nativity in England unknown. He was among the early settlers of Weymouth, and a member of the church there; many years a selectman, often on important committees, and also commanded a military company, and was representative to the general court in 1637-40-57-71.

There were born to Pulaski Pliny and Venitia (White) Carter six children: 1. Pulaski, born June 2, 1883; educated in the Scranton High School, from which he graduated in the class of 1903, the Boston School of Technology and Columbia University; married Pearl Lidstone. 2. Phebe, born September 14, 1885; educated in the Scranton High School, Smith College, Northampton, Massachusetts, and Columbia University, receiving the degree of A. M. in 1913; teacher in Technical High School, Scranton. 3. Ina, born March 1, 1888, died January 26, 1897. 4. Olive Ingalls, born November 9, 1890; educated in Scranton High School, Smith College, Northampton, Massachusetts, and Columbia University, receiving the degree of A. M. in 1913; teacher in Meriden High School, Meriden, Connecticut. 5. Ada, born November 3, 1893; educated in Scranton High School and Smith College, attending the latter institution at the present time (1914). 6. Roy, born July 13, 1899; a student in Scranton High School.

(IX) Marvin Phineas Carter, youngest child of Pulaski and Olive (Ingalls) Carter, was born November 28, 1857. He was educated at East Greenwich, Rhode Island. He is one of the successful business men in Scranton, the owner of valuable real estate, a director in the People's Bank, and otherwise actively identified with the business of the city. He married Minnie Parmelia Murphy, born June 26, 1863, daughter of John Archbald Murphy, of Warrenton, Connecticut. He was several times elected to the state legislature, and was a man of business prominence in the town where he resided. His mother was Mary, daughter of Benjamin Spaulding, descended from Ed-

mund Spaulding, who came to Braintree, Massachusetts, about 1630. To Mr. and Mrs. Carter were born three children: 1. Marvin Clarence, born July 29, 1885; a graduate of the high school, class of 1905, graduate of Lafayette College. 2. Lucius, born November 20, 1887, died June 3, 1889. 3. Marguerite, born May 30, 1889; graduate of Scranton high school, graduate of Mt. Holyoke College, Mt. Holyoke, Massachusetts.

Mr. Carter, the father of the family above named, whose career as a man of affairs and a humanitarian has been treated of in the foregoing narrative, met with a dreadful accident from the effects of which he never entirely recovered, and which doubtless shortened his life. In November, 1876, while driving in his carriage, his vehicle was driven into by two teams driven by drunken racers. Mr. Carter was caught in the wreckage and so seriously injured that for some days his life was despaired of. His excellent constitution, unimpaired by reason of his abstemious habits, enabled him to resume his accustomed avocations, but he never regained his old vigor. He died October 13, 1884, aged seventy-one years, leaving to survive him his widow and their three children. His widow died December 8, 1898.

---

#### GEORGE J. LUCAS, J. U. D., D. D.

There is found in Rev. George J. Lucas, J. U. D., D. D., rector of St. Patrick's Roman Catholic Church, of Scranton, Pennsylvania, a blending of scholarly attainments and ministerial fidelity that do credit to the man possessing them. If culture may be gained in excess and the lure of study become harmful, its harm is in the temptation it brings to give to it paramount importance and to allow the delights of deep intellectual pursuits to exclude the sterner duties, the less inviting realities of life, to place a clouding veil over the features of existence more enjoyably forgotten. Despite the honors that have been showered upon Dr. Lucas, the distinction that he has received as an author, educator and scholar, has neither made him regardless of his priestly responsibilities nor lessened his anxiety for the welfare of the people to whom he ministers.

The Lucas family is of French origin, the line having been founded in Ireland by a Huguenot ancestor who had fled the land of his birth. The grandfather of Rev. George J. Lucas was a native of Ireland, and embraced the religion of the Society of Friends. His son George, father of Rev. George J. Lucas, was a master of the workhouse at Youghl, county Cork, and in that locality passed his entire life. He married Margaret Field, of county Cork, a communicant of the Catholic faith, and in that their children were reared. George and Margaret (Field) Lucas were the parents of: Margaret, Thomas, Mary, George J., whose name heads this sketch; Frederick, John, William.

Rev. George J. Lucas was born at Youghl, county Cork, Ireland, May 22, 1852. Almost from his childhood his education was directed toward the priesthood, his early training being received under the direction of the Christian Brothers of Cork, and after coming to the United States his preparation consisted of a three years' course in philosophy and a four years' course in theology under the Jesuit Fathers at Woodstock, Maryland. He was ordained in St. Mary's University, in Baltimore, Maryland, October 28, 1880, Cardinal Gibbons officiating at the ceremony, and in June of the following year he received the degree of Doctor of Divinity from the same university, his first charge after his ordination being as assistant to Rev. E. J. Melley, of St. John's Church. When the degree of Doctor of Divinity was conferred upon him at St. Mary's University, Cardinal Gibbons, and the chancellor of the

Catholic University of America, then only one year in existence, and Monseigneur Schroeder, the dean of the Catholic University, requested Bishop O'Hara, then Bishop of Scranton, to permit Rev. Dr. Lucas to prepare a standard of degrees of theology for the Catholic University of America, to which candidates for the degree of Doctor of Divinity should conform, and the permission of the Bishop having been granted, Rev. Dr. Lucas prepared such a standard, which was accepted by the authorities of the institution. In order to prepare this work, Rev. Dr. Lucas entered upon a five year period of study, the first of which was spent in the Catholic University of America, and the remaining four in private research and study. The greater part of this time was devoted to the preparation and writing of a dissertation for the doctorate in theology at the above mentioned university, the subject of which is "Agnosticism and Religion," the whole being an examination of Spencer's "Religion of the Unknowable," preceded by a history of agnosticism, from Xenophanes to Herbert Spencer. This is probably the most standard work on the subject from the point of Christianity, regardless of denominational differences, that has ever been written, and its fairness of treatment, as well as the high literary standard that has been maintained throughout, has won for it the most favorable criticism from the American and European press. One of the most commendatory notices that has come to the hand of the author, and one especially valued because of its celebrated source, is a personal letter of three pages from the late William E. Gladstone, the famous English statesman, in which he expresses his great satisfaction with the scholarly disquisition and his appreciation of the spirit of toleration which pervades the book. The work was published by the Christian Press Association Publishing Company, of New York, in 1895, and it was after submitting his dissertation to the Catholic University of America that he was awarded his Doctor of Divinity degree from that institution in 1905, a degree that has been conferred but fourteen times in nineteen years by that university, his being the first to be conferred.

Dr. Lucas is the author of a series of articles on the "Origin of Evil," mainly in refutation of the well known publication of Professor Fisk dealing with that subject, through which Dr. Lucas added to the brilliancy of his literary fame and gained still greater repute as a thinker, logician and scholar. He has taken a place among the most noted writers of the day on religious topics, and aside from the substantial value of his writing the reflection of the workings of a master intellect, the ease and grace of his expression wins the admiration of those who care to delve no deeper than the surface beauty of his work. Numerous articles above Dr. Lucas' signature have also appeared in the New Catholic Encyclopaedia. In 1910 the Papal University at Rome, commonly known as the "Apollonnaire," conferred upon him the degree of Doctor of Canon Law, one year later adding to this that of Doctor of Roman Civil Law, the two expressed by J. U. D., a degree with which but very few priests in the United States have been honored. Dr. Lucas has had the honor of being invited to be present as a special examiner of all the candidates for the degree of Doctor of Divinity in the Catholic University of America. This is the only post-graduate Catholic University in the world, one of the requirements for admission being a certificate of graduation from a duly recognized seminary, and the scholarship of graduates is perhaps the highest of any Catholic university in the world.

Dr. Lucas' ministerial record comprises eight months of service as assistant of Rev. A. J. Melley, of St. John's Church, after which he became assistant to Rev. John Moylan and T. J. Comerford, of St. Thomas' Church, Archbald, Pennsylvania, where he remained for four years. For the next five months he

served in the same capacity with Rev. J. B. Donovan, of Dunmore, then being appointed to his first rectorate, at St. Andrew's Church, of Blossburg, Pennsylvania. His ministry in this place extended over a period of twelve and one-half years, during which time he conducted a valuable work among his parishioners, and the following three years he was rector of St. Mary's Church, at Pittston. On January 1, 1912, he received his appointment as rector of St. Patrick's Church, in Scranton, which church and city has since been the scene of his ministerial endeavors. His church is a thriving and prosperous one, financially strong and spiritually powerful, exercising an influence potent and far-reaching in the community. He has been appointed as examiner of the clergy of Scranton, serving for the past nine years, and of the most important local offices in the diocese. He is also one of the directors, and the secretary and treasurer of St. Patrick's Orphan Asylum. On October 28, 1914, Father Lucas will have been priest for twenty-five years and on Sunday, October 25, 1914, he will celebrate the silver jubilee.

---

#### GEORGE L. PECK

Those who cavil at ancestry and deride the doctrine of heredity may with profit study the history of the Peck family in America. From the days of heraldry, three crosses formed the principal part of the Peck coat-of-arms. This indicates service in the Crusades, which proves the militant trait. Many, many years thereafter this trait shows in Jesse Peck, of the fifth American generation, who with three of his sons served in the Revolutionary army. In the next generation, the spirit of the three crosses is manifested in Luther Peck with whom Methodism came into the family. He was for many years a class leader of the Methodist Episcopal Church, and distinguished for his fidelity to every duty and his devotion to the cause of Christianity, the same spirit that drove the old Crusader to the Holy Land in an endeavor to wrest the Saviour's tomb from the grasp of the Saracen. Witness the result of heredity in the sons of this God-fearing old Methodist class leader. All five of them became eminent ministers of the Methodist Episcopal Church, one of them, Rev. Jesse Truesdell Peck, D. D. LL.D., being elected in 1872 bishop of that church and serving with such distinction that the name Peck vies with that of Simpson in the affection and esteem of Methodists everywhere. Two of these sons were also distinguished authors. Five of the grandchildren of Luther Peck were also eminent ministers of the Methodist Episcopal Church. So we can let heredity answer for itself through this wonderful Peck family, so honored and revered in the annals of Methodism and eminent in whatever station placed or profession followed. The name Peck is of great antiquity in England, and is found in every civilized country. In America it first appears with Henry Peck one of the founders of the New Haven Colony and his name appears as one of the subscribers to the charter of the New Haven Colony. He settled in New Haven, Connecticut, in 1638. The family home continued in New Haven during the next two generations, headed by John (1) and John (2) Peck.

(IV) Eliphalet Peck, son of John (2) Peck, and of the fourth American generation, left New Haven when young, spending most of his life in Danbury, Fairfield county, Connecticut.

(V) Jesse Peck, eldest son of Eliphalet Peck, settled in the southern part of Danbury (now Bethel) where he cleared a farm from the original forest. In Jesse and his son was revived the ancient military spirit of the family, he with his three sons enlisting in the Revolutionary army; Jesse and his son Nathaniel contracted smallpox and died before the war ended. The other two

sons were captured in battle, carried to New York City and confined in the old hulk Jersey anchored in the East river, and used by the British as a prison ship. Here they suffered the greatest horrors, and when finally released and carried home were to broken down by disease and brutal treatment that for a time they were unable to recognize their own mother. Jesse Peck married Ruth Hoyt, born February 26, 1738, died February 2, 1809.

(VI) Luther Peck, son of Jesse Peck, the Revolutionary soldier, left Connecticut with his family in 1794, settling in what is now Middlefield Center, Otsego county, New York. With Luther Peck begins the connection of the family with the Methodist Episcopal Church. He was a class leader for many years, and a man of most exemplary Christian life. He reared a remarkable family, all of his five sons becoming eminent ministers of the Methodist Episcopal Church, as were five of his grandchildren. He married Annis Collar, whose father was also a Revolutionary soldier. They were the parents of eleven children, the youngest being Rev. Jesse Truesdell Peck, a well known and greatly beloved bishop of the Methodist Episcopal Church, who died May 17, 1883, eleven years after his elevation to the Episcopacy.

(VII) Rev. George Peck, D. D., second of the five famous sons of Luther Peck, was born in Otsego county, New York, August 8, 1797, died in Scranton, Pennsylvania, May 20, 1876. He joined the Methodist Episcopal Church at the age of fifteen years, and three years later was licensed as an exhorter. The following year, 1816, he was licensed a local preacher and served on the Cortland (New York) circuit without salary. In the same year he was received into the Genesee Conference on trial. He advanced rapidly in the esteem of his brethren, becoming in 1824 presiding elder of the Susquehanna district, being then but twenty-seven years of age. In 1835 he was elected principal of Cazenovia Seminary, continuing three years. In 1839 he was again presiding elder of the Susquehanna district, and from 1840 until 1847 was editor of the Methodist Quarterly Review, his editorship marking a new era in the history of that magazine; from 1847 until 1851 he was editor of the official organ of the church, *The Christian Advocate*. In 1852 he returned to the active ministry, stationed at Wilkes-Barre, Pennsylvania. In 1854 he was presiding elder of the Wyoming district; in 1855 of the Binghamton district; in 1856 and 1857 in charge of Scranton Mission (now Elm Park Methodist Episcopal Church); in 1858 presiding elder of the Wyoming district; stationed in 1866-67 at Providence; in 1868 at Dunmore; in 1869 presiding elder of the Wyoming district. In 1873 he was placed on the supernumerary list, having most gloriously served his church as exhorter, preacher, presiding elder and editor for fifty-eight years. Three years later, in 1876, he died.

His interest in educational matters was intense. He had labored for the advancement of Cazenovia Seminary long before he became its efficient president in 1835. One of his biographers claims that he was "the originator of the first course of study prescribed by the general conference for traveling preachers" and that he was "the originator and first moving spirit in the founding of Wyoming Seminary." He was a delegate to the general conference in thirteen sessions, 1824 to 1872, and was a member of the Evangelical Alliance which met in London, England, in August, 1846. Throughout almost his entire ministerial career, he was a valuable contributor to the literature of the Methodist Episcopal Church and in other fields of literature, enjoying the reputation of a faithful and accurate writer.

In 1835 Wesleyan University conferred upon him the degree of Master of Arts and in 1840 Augusta College bestowed that of Doctor of Divinity. Says another of his biographers: "I view him as one of the most remarkable men of our times, one whose genius and piety are indelibly stamped on the ec-



clesiastical policy and wonderful growth of the church, whose wise counsels and herculean labors are interwoven in its development. For the past fifty years of his life he has been distinguished by a devoted love to the church, and unswerving loyalty to the honest convictions of truth."

Rev. George Peck married Mary, daughter of Philip and Martha (Bennett) Myers. Of his five children two sons, Rev. George Myers Peck and Rev. Luther Wesley Peck, were ministers of the Methodist Episcopal Church; a third son died in infancy; a fourth, Wilbur Fisk Peck, was a graduate in medicine, of the University of the City of New York and a surgeon in the Union army. An only daughter, Mary Helen, married Rev. J. T. Crane, a graduate of Princeton College and a minister of the Methodist Episcopal Church.

(VIII) Rev. Luther Wesley Peck, second son of Rev. George Peck, D. D., was born in Kingston, Pennsylvania, June 14, 1825, died at Scranton, Pennsylvania, March 31, 1900. He spent one year at Wesleyan University (1842) then entered the University of the City of New York, whence he was graduated Master of Arts, class of 1845, receiving from his alma mater in 1878 the degree of Doctor of Divinity. After leaving the university he finished a course of theological study, and in 1845 was admitted to the New York Conference of the Methodist Episcopal Church, following in the footsteps of his honored father. He was stationed, under the itinerant law of the church, as pastor of churches in New York, Brooklyn, Durham, Rhinebeck, Newburgh, Poughkeepsie, Kingston, Middletown and other places until 1868, when he was transferred to the Wyoming conference, Pennsylvania. He continued in the ministry forty-five years; was presiding elder of the Honesdale district, 1876-79, and retired from active ministry in 1891 at the age of sixty-six years. He was a rarely eloquent pulpit orator, a pastor of great usefulness and a forceful, graceful, pleasing writer of both poetry and prose. His published works include: "The Golden Age" (1858); "The Flight of Humming Birds" (1895); A Poem "The Burial of Lincoln" for Rev. Jesse T. Peck's "History of the Great Republic," and edited, "A View From Campbell Lodge in Wyoming" written by his father, Rev. George Peck. He was also an extensive and valued contributor to the National Magazine, the Quarterly Review and the Ladies Repository. In his long and active life he accomplished great good and added additional lustre to the name of Peck, already illustrious in the annals of Methodism.

Rev. Luther Wesley Peck married, January 18, 1848, Sarah Maria, daughter of Dr. Ransom Hall and Helen (Whitbeck) Gibbons. She was born in Dormansville, Albany county, New York, in 1828, died June 17, 1911, in Scranton, Pennsylvania. Children: Helen, Mary E., Emma D., Frances A., Sarah M., Susan G., Jessie T., Fanny M., George L.

(IX) George L. Peck, only son of Rev. Luther Wesley Peck, D. D., was born in Susquehanna, Pennsylvania, February 12, 1869. After a course of study in the public schools, he prepared for a higher institution of learning at Cazenovia Seminary, a school that for three years was presided over by his grandfather, Rev. George Peck, D. D. In 1886 he entered Wesleyan University, whence he was graduated Bachelor of Arts, class of 1890. Breaking away from family tradition, he chose the profession of law, preparing under the preceptorship of Cornelius Comegys, an eminent lawyer of Scranton, Pennsylvania. Passing the necessary examinations, he was admitted to the Lackawanna county bar, April 10, 1893. He at once began the practice of his profession in Scranton and so continues, having attained high standing at the bar and practices in all state and federal courts of the district.

Not only has Mr. Peck gained honorable distinction in his profession but is

numbered among the active, useful and successful business men of his city. He is president of the Electric City Bank of Scranton, a solid, prosperous, financial institution, and is manager of the Board of Trade and Real Estate Company, with offices in the Board of Trade Building. Adhering strictly to the faith of his fathers, he is a useful member of Simpson Methodist Episcopal Church, president of its board of trustees and for the past eighteen years has been superintendent of the Sunday school. Thoroughly informed in church government, history and precedent, Mr. Peck has rendered valuable layman service to the church, and in 1912 was chosen lay delegate to the quadrennial general conference, held that year in Minneapolis, ably representing there the lay interests of his church.

Through the service of his patriotic ancestor, Jesse Peck, the Revolutionary soldier, Mr. Peck had gained membership to Pennsylvania Chapter, Sons of the Revolution, an association he greatly values. He is also prominent in the Masonic Order, belonging to Peter Williamson Lodge, Free and Accepted Masons; Lackawanna Chapter, Royal Arch Masons; Coeur de Lion Commandery, Knights Templar (of which he is past eminent commander); Irem Temple, Nobles of the Mystic Shrine.

This brief account of the life and activity of Mr. Peck gives but an idea of his usefulness to his community, but does fully prove his own worthiness and the high character of his forbears, dating from the first American ancestor, Henry Peck. As a study in heredity, it is of deep interest and furnishes an unswervable argument in favor of the exponents of the theory that "blood will tell."

George L. Peck married, September 10, 1896, Helen Abigail, daughter of Frank W. and Harriet C. (Kilmer) Mott. Children: George Francis, James Knickerbocker, Jesse Truesdell, Mott. The family home is at No. 145 South Hyde Park avenue.

---

#### JOHN VON BERGEN, JR.

As chief executive of Scranton borough, Mayor Von Bergen justified the wisdom of the voters of the city, and so far as his power extended he gave the friends of good government satisfaction in their choice. While not a native born son of Scranton, his earliest recollection does not carry him beyond the city, as he was but a child of three years when his parents first made Scranton their residence. Here he was educated and grew to manhood, imbibing the true Scranton spirit of progress, engaged in business, entered public life and gained the prominence and reputation that resulted in his election to the high office of mayor of the third most important city of Pennsylvania.

(I) The Von Bergens are a Swiss family, Mayor Von Bergen being representative of the first American born generation. The first of the family to leave their far away mountain home and to come to the United States was Andrew Von Bergen, who with his wife, Elizabeth, and children, came about 1851, settling in Jackson, Illinois. He was a carpenter by trade and after working in Illinois until 1856, came to Pennsylvania, locating in Taylor, where he engaged in farming.

(II) John Von Bergen, son of Andrew and Elizabeth Von Bergen, was born in Berne, Switzerland, April 18, 1845. He was brought to the United States by his parents when about six years of age, and to Taylor, Pennsylvania, when eleven, having spent the intervening years in Jackson, Illinois. He received such education as the public schools afforded, and at Taylor assisted his father in farm labor until of suitable age to enter the coal mines. He worked at mining several years, winning his way upward until he became a min-

ing contractor. In 1877 he located in Scranton and there was actively engaged in business until his death, April 15, 1910. He was a man of forceful character, genial and kindly in nature, but of so retiring and quiet disposition that he was known as the "Silent Swiss." He was a director of the Providence Bank, served two terms as councilman in Scranton, then was elected director of the poor of the city, holding that office until his death. He was a member of Schiller Lodge, Free and Accepted Masons, the Independent Order of Odd Fellows and Greuth-Verein. He was deeply interested in religion though not a professed member of any denomination and was liberal to all churches. It is in commemoration of these characteristics of Mr. Von Bergen that the congregation of the Court Street Methodist Episcopal Church are now assembled by the tones of a strong, richly toned bell, inscribed "Presented to the Court Street Methodist Episcopal Church, March 23, 1913, by John Von Bergen, Junior, in memory of his father, John Von Bergen, deceased." In presenting the bell to the congregation, the donor said in part. "I believe that whatever honor accrues from this contribution should go to him who first conceived it: Should go to him in whose honor this contribution is now made. I believe that it belongs to him, rather than to me who am now carrying out what I know to have been his most heart-felt wish. My satisfaction will come too, with every toll of this bell, for the sound of it as it peals forth from the belfry of this church, will bring back to me a very vivid recollection of one whom I believe to have been the best father that a son ever had." John Von Bergen married Caroline Weisen, born in Scranton, daughter of Nicholas Weisen. She was also a devoted Christian. Children: Elizabeth, married Wells Hockenberry, of Scranton; John, of whom further; Caroline, a teacher in Scranton public schools; Mildred, married R. W. Jeffers, of Scranton; Louis, of Stanton; Helen.

(III) John (2) Von Bergen, eldest son of John (1) and Caroline (Weisen) Von Bergen, was born in Taylor, Pennsylvania, November 15, 1874. He was educated in the Scranton public schools and Wood's Business College, beginning business life as weighmaster in the employ of the Delaware, Lackawanna & Western Railroad Company. He continued in the employ of that company until 1900, serving in different capacities, rising to a position virtually that of outside assistant superintendent. He then resigned, becoming clerk in the office of the commissioners of Lackawanna county, remaining four years. In 1904 he was elected clerk of courts for Lackawanna county, serving one term, but failing of re-election. In 1909 he was successful candidate of the Republican party for mayor of Scranton. He was sworn into office, April 5, 1909, and served the city with a fidelity and zeal that won him hosts of friends and warm supporters. He is a director of the Providence Bank and of the Anthracite Traction Company, and interested in other business enterprises. He has attained prominence in the Masonic Order, belonging to Queen Ridge Lodge, Free and Accepted Masons, and to all bodies of the Ancient Accepted Scottish Rite, Keystone Consistory, in which he holds the thirty-second degree. He is also a Noble of Irem Temple, Nobles of the Mystic Shrine, of Wilkes-Barre, Celestial Lodge, Independent Order of Odd Fellows, the Fraternal Order of Eagles and the Modern Woodmen of America, being very highly esteemed by his brethren in these orders.

Mr. Von Bergen married, September 28, 1904, Emma, daughter of Christian G. Schwindt, of Scranton. Children: Mildred and John (3).

## FRIEND A. CROSS, M. D.

It has been a noticeable feature of American life, and indeed of the age, that the tendency in all of the sciences and professions has been to develop men complete masters of one branch of a calling. The depth of research and the profundity of theories advanced have been accompanied by the realization that life is too short and the undertaking too vast for one to learn, understand and be an authority upon all departments of even one science or profession. So the need of specialization has been felt and to accommodate this want learned men in all walks of life have concentrated their mental faculties upon one subject, or part of a subject, making everything known thereof their own and ceaselessly experimenting, searching and studying to add to this store of accurate evidence. As one wise man, apt in expression, summed up the need of the times, what is required is not simply broad men, but "broad men sharpened to a point." It is in the application of this method to the medical profession in the case of Dr. Friend A. Cross that the above is pertinent at the present time.

Dr. Friend A. Cross is a descendant of a family old in Wayne county, Pennsylvania, his grandfather, James Cross, having been an early settler who there engaged in lumber dealing. The father of Friend A. Cross, Albert James Cross, was born in Sterling, Wayne county, Pennsylvania, in 1849, and was for several years a teacher in the public schools, later opening a general store in the place of his birth, where he is now engaged in the mercantile business. He holds membership in the Methodist Episcopal Church. Albert James Cross married Mary E. Hildebrandt, of Columbia, New Jersey, and has children: Freeman H., Clarence G., Friend A., of whom further; Russell E., deceased; Earl B., Beulah C., H. Milton.

Dr. Friend A. Cross, son of Albert James and Mary E. (Hildebrandt) Cross, was born in Sterling, Wayne county, Pennsylvania, July 8, 1882. After a public school education he attended the East Stroudsburg State Normal School. For two years he was a school teacher, in 1903 entering the Medico-Chirurgical College of Philadelphia, whence he was graduated M. D. four years later, then serving for one year as interne in the State Hospital. In 1908 he moved to South Scranton, beginning the practice of his profession on Pittston avenue, a short time afterward enrolling in the New York Post Graduate School and Hospital, in New York City, where he specialized in the study of eye, ear, nose and throat, returning to Scranton in August, 1913. His present office is in the Dime Bank Building, in which place he receives the many patrons of his large practice, his knowledge, skill and ability as a physician being universally known. From 1908 to July 1, 1914, Dr. Cross was an assistant to Dr. Mears and Dr. C. L. Frey, of the State Hospital, in cases where the disease is of the eye, ear, nose or throat, his advanced study making him an assistant of worth. On July 1, 1914, he was made chief of the eye department of that hospital. The many years that in all probability stretch before Dr. Cross offer excellent ground for the laying of a career of brilliance and usefulness, for he is absorbed in his profession, a tireless worker, and a constant student. His medical societies are those of the county and state, and he is a member of Lodge No. 330, F. and A. M., of Hamlin, Pennsylvania. His church is the Elm Park Methodist Episcopal. Dr. Cross married, December 1, 1909, Lulu A., daughter of Hon. John D. and Mary Houck.

---

 MAJOR EVERETT WARREN

There is a spirit in the American people that in some manner can never resist the appeal made to the senses by the words of Bunker Hill. The mere



*F. A. Cross*



utterance of these magic syllables causes each head to be held a trifle higher, each pair of shoulders to be raised a little more erect and each breath to come a little quicker than its predecessor. It is a glorious monument to the Warren family herein recorded, that the name of one of its members has been written indelibly upon the records of our mighty republic, as the hero of that historic conflict, General Joseph Warren.

(I) Isaac Warren, related to General Joseph Warren in a collateral line, has the distinction of introducing a new industry in this country, the manufacture of calf skin boots. He was the father of several children, one of his sons, George Frederick Warren, serving with honor in the Civil War, and being placed upon the staff of General Grant at the request of that officer.

(II) Harris Franklin Warren, son of Isaac and Leonora Warren, was born in Bethany, Connecticut, March 10, 1824. In 1838 he went with his brother to Newburgh, New York, where for a year he attended high school. Going west in 1843, he was employed as a bookkeeper in the large wholesale establishment of Reuben Towne in Detroit, Michigan, a position he resigned in 1848 to enter the service of the mercantile house of Zacli, Chandler & Company, of which he became junior partner in 1850. The western climate proving unfavorable to his delicate health, Mr. Warren returned to the east and accepted a position in Scranton in the car and machine shops of the Delaware, Lackawanna & Western Railroad. For almost ten years he suffered as a semi-invalid, finally recovering the strength and robustness that have always characterized the family, and lived to an advanced age. Had his health been as vigorous as his spirit, it is possible that his efforts in a military line would have redounded quite as much to the honor of the family as did the deeds of his valiant ancestor, as his enlistment in the Union army at the time of the Civil War was barred by the examining physician. He married twice and became the father of three children.

(III) Major Everett Warren, son of Harris Franklin and Marian Margery (Griffin) Warren, was born in Scranton, Pennsylvania, August 27, 1859. Having obtained from the public schools of the day all that they had to offer, his insatiable desire for learning as a means of self improvement led him to enter Merrill's Academic School, where he obtained instruction in Latin and Greek, preparatory to entrance into college, paying his tuition fee with his earnings as a carrier of the Scranton Republican, subsequently for the Scranton Times. Not having all the preparation necessary for college entrance, he continued to study under the tutorship of Frank Bentley, paying for this service with three-fourths of the wages he earned as clerk and office boy in the office of A. H. Winton and later of Hand & Post. Such perseverance and ambition, such undaunted and immovable determination to obtain an education, such sincere desire for better things, could not remain unrewarded, the fall of 1877 witnessing the fulfillment of his college hopes and the gratification of a wish for which he labored long and unceasingly, his matriculation at Yale University. Here he applied all the energy and labor to the different departments of his course that he had previously devoted to obtaining entrance, gaining special pleasure from the literary and debating work of the college, including an editorship of the Yale News, and graduating A. B. in the class of 1881. After graduation he studied for the legal profession, and soon after his admission to the bar became the partner of the Hon. E. N. Willard, Judge H. A. Knapp joining the firm in 1892, the triple alliance continuing until June, 1895, when Mr. Willard received appointment as a superior court judge from Governor Hastings. Since that time Major Warren has been the head of the firm, and has maintained a position as one of the leading members of the Scranton bar, the business of the firm thriving because of the excellent reputa-

tion borne by all partners. The firm was Warren & Knapp until Judge Willard retired in 1898 and resumed his place in it, continuing until his death, March 2, 1910. The firm then became Warren, Knapp & O'Malley, remaining such until January 1, 1914, when it became Warren, Knapp, O'Malley & Hill. Mr. Warren has represented individuals as well as corporations in as fully important controversies as those of the Delaware, Lackawanna & Western, the New York Central, the Lehigh Valley, the Erie and the Erie & Wyoming Valley railroads, the Scranton Traction Company, the Lackawanna Iron and Steel Company, and the Pennsylvania Coal Company. We cite the Crawford will case, and the Martin case against the Delaware & Hudson, Susquehanna & Western Canal companies, when the biggest verdict was given that was ever obtained in a personal injury case in Pennsylvania. To recount the reasons for his continued success in his chosen profession entails a description of the qualities of the man himself, his strong mentality, prepossessing personality and confident self assurance, which make a most favorable impression upon all with whom he comes into contact. All of his success, of course, is laid upon his extremely intimate and thorough knowledge of fundamentals, which enables him to unravel thread by thread the most complicated and abstruse of legal problems; but aside from this, without which a lawyer could never be truly great, his remarkable forensic gifts have been the greatest aid to him in his profession. Just as the most beautiful of songs loses its entire charm by a poor rendition, so the strongest legal attack loses its force and power of conviction unless its delivery is eloquent, well balanced and emphatic. In the presentation of his cases, Major Warren combined all of these qualities, with a result shown by the number of decisions in his favor.

Major Warren's distinction is not confined to the bar of his state, but reaches into political and military circles. His connection with the Pennsylvania National Guard began in 1881, when he enlisted as a private in Company A, Thirteenth Regiment, then commanded by Captain Louis A. Watres, who afterward became lieutenant-governor of Pennsylvania. His promotion to sergeant-major followed in three years, his next rank being that of adjutant and finally judge advocate of the Third Regiment with the rank of major on the staff of General J. P. S. Cobin. In 1891 he resigned as judge advocate and closed an association with the National Guard which had covered a period of ten years, during which time he had been constantly active in the work of the organization. He was offered a position on the staff of Governor Hastings as colonel, which he refused, and he also declined the position of judge advocate on Major General Snowden's staff with the rank of lieutenant-colonel.

In the field of Republican politics he has gained a position of influence and power, and is one of the leaders in the party in that state. In 1887 the first convention of the recently organized National League of Republican Clubs was held in the old Chickering Hall in New York, where Major Warren was the representative of the Central Republican Club of Scranton, and in the election of National officers was the unanimous choice of the Pennsylvania delegation for treasurer. At the organization of the State League of Pennsylvania at Scranton in April, 1888, he was chosen the first of three vice-presidents and six years later was elected president by acclamation, and at York in 1895 was re-elected, continuing as the chief executive officer of the league until 1896. He has been a member of the advisory committee of the National Republican League, his advice and opinions carrying great weight whenever, after mature consideration of the subject at hand, he either gives the one or advances the other. Twice he has declined allowing his name to be used in connection with a nomination for Justice of Supreme Court of Pennsylvania. In local politics, too, his knowledge of affairs has called him into



service. As secretary of the county committee, chairman of the city committee, and as a member of the advisory board of the state committee, he has fulfilled all the duties of a good, conscientious citizen. At the state convention in Harrisburg in 1896 he was nominated presidential elector from the eleventh congressional district.

Major Warren and his wife are communicants of St. Luke's Episcopal Church, he serving as vestryman. He has been a member of standing in committees of the diocese of Bethlehem for twenty years, and deputy to the General Convention of the Episcopal Church. He holds fraternal affiliation with the Masonic Order, belonging to Peter Williamson Lodge, Free and Accepted Masons; Lackawanna Chapter, Royal Arch Masons; and Melita Commandery, No. 68, K. T. He was chairman of the First City Planning Commission of Scranton under appointment of Mayor Von Bergen. He is also a member of the Yale Club of New York, the University Club of New York, the Scranton Club and Country Club of Scranton.

On May 31, 1883, Major Warren married Ellen H., daughter of Hon. E. N. Willard. Children: 1. Marian Margery, married Worthington Scranton, vice-president of the Scranton Gas & Water Company. 2. Dorothy J., married Nathaniel H. Cowdrey, of New York City. 3. Edward Willard. Major Warren personified the type of American citizen in whom lies the hope of purity in our local, state and national politics. An honorable, upright, Christian gentleman, deserving and holding the regard of all, highly trained in legal matters, and closely acquainted with the vital issues of the day, his life has shown nothing but a lofty attitude of service to society and earnest effort in behalf of his city and state.

---

#### ELIAS G. ROOS, M. D.

At the close of his quarter of a century of professional relation to the city of Scranton, it is the privilege of Dr. Elias G. Roos to look back upon that period and find therein only that which has added to his fame in his profession and has raised him to a lofty place in the regard of the many friends he has made since coming to that city. Beyond the peradventure of a doubt one of the most learned physicians and surgeons of the city and state, the nobility of his character and his attractive personality would have gained him prominence had not his professional ability been of so high an order. He is a member of an old German family and in that country prepared himself for the practice of medicine and surgery, attending the best of the many excellent universities of which that country boasts.

His grandfather, Samuel Roos, and his father, Rabbi Kaufman Roos, were both life-long residents of Germany, where the latter was born, in Lichtenau, Baden, in 1809. Kaufman Roos obtained his education for the rabbinal at the world famous university, Heidelberg, in the grand-duchy of his birth. After the completion of his theological studies he was honored with a call to the old and well known Jewish Community in Schmilheim, Baden, where he performed the duties as District Rabbi for forty-one years or up to the time of his death. He married Zippora Rice, whose paternal line for three generations had been rabbis and teachers of the Jewish law. Her brother, Simon, born in Breisach, Baden, Germany, came to the United States when he was seventeen years of age, and in 1860 established himself in the grocery business. Several years later he admitted his brother, Max, to a partnership in the business, under the firm name of Simon Rice and Brother. They engaged in a wholesale grocery business in Scranton until the retirement of Simon from the firm, aged forty-seven years, after which time Max Rice continued

the business independently. Simon Rice died in 1901. He had been one of the earliest settlers of the city of Scranton and was a member of the "Old Guard" of business men of that place. While he did not reap as abundantly of the harvest of wealth that the region offered as some of his contemporaries and those that followed them, all of his efforts in behalf of the city were tendered in open-hearted generosity and not through hope or desire of private gain. He was a supporter of Republican principles and as the candidate of that party was twice elected a member of the Scranton council, in which body he had a fuller opportunity to work effectively for the city's advancement, which he did with energetic zeal. For many years he was an official of the Madison Avenue Jewish Synagogue, in which faith he had been strengthened by the self-sacrificing example of his father, his grandfather, and his great-grandfather. Rabbi Kaufman Roos died in 1875, his wife surviving him eighteen years, her death occurring in 1893. Children of Rabbi Roos: Gotthilf, born in 1857; Frida, born 1858; Elias G., of whom further; Sara, 1865; Emilie, 1868.

Dr. Elias G. Roos was born in Schmilheim, Baden, Germany, February 7, 1860. His early education was obtained in the high school at Ettenheim and later on in the gymnasiums at Freiburg, Rastadt and Mannheim, from which latter place he was graduated in 1881 after a course of study extending over a period of nine years, so minute and thorough is the German system of education. He then entered the University at Freiburg, subsequently attending those at Konigsburg and Berlin, receiving after seven years of the most arduous study the degree of M. D. He soon after came to Scranton and immediately began practice in that city. His rise to popular favor was rapid and for seven years he continued a prosperous practice. At the expiration of that time, in spite of his unusually liberal education, he felt that he would be benefitted by a course in an American institution, and accordingly enrolled at the Philadelphia Polyclinic College for Graduates in Medicine in 1897 and in this college was the winner of a fellowship. There is, in that action of Dr. Roos a sermon for many a youth, or indeed, for those of more mature age, that is, that in direct proportion to the amount of knowledge acquired, unexplored fields open ahead. He then returned to his Scranton patronage and has there ever since remained, ever becoming more firmly entrenched in the affection of those who are privileged to know him best, and as constantly rising in the respect of the many who are acquainted with him only through reputation and the report of his achievements along medical and surgical lines. He holds position as consulting surgeon to the Midvalley Hospital and as one of the visiting surgeons to the State Hospital in the city, and is examiner for several life insurance companies. Dr. Roos belongs to the County, State and American Medical societies, and to the Congress of Surgeons of North America. His political views are Republican in sympathy, and he is a member of the Madison Avenue Temple.

He married (first) in 1891, Frances Wertheimer, of Philadelphia, who died in 1895; (second) Edith Hirschmann, of Binghamton, New York. Children of first marriage: Beatrice Frances and Henrietta Frances.

Perhaps the most attractive point about the career of Dr. Roos is the vast amount of good he has been able to accomplish as the direct result of the years of study and preparation spent in Germany. He could not possibly have seen the goal of his efforts and yet the faith that kept him so closely to his studies has been more than justified in the reward that has come to him in the lessening of human suffering and in restoring to some the use of faculties long dormant, bringing to many the light and inspiration of fresh hope for useful lives.

## CHARLES H. VON STORCH

In Charles H. Von Storch the city of Scranton has found a citizen who, called upon to fill numerous responsible positions in municipal life, has never failed to respond willingly, to accept any trust, and, having accepted it, has remained true thereto until his every obligation has been discharged. Numerous of Scranton's institutions have felt his strengthening guidance, and for two decades he has been prominent in the work of the school board, having several times been its president, an office he ably administers at the present time. But a full recital of his activities follows in its proper place.

The family of Von Storch was a noted and famous one in Germany, from which country the name has disappeared, one branch becoming numerous in Russia, another, founded by Heinrich Ludwig Christopher Von Storch, flourishing in the United States. The family record traces to Per. Staerch, who married, at Wassbro, a daughter of Lars Oloffson. His coat-of-arms was adopted by his son, Jon Persson Staerck, upon his introduction into the Hall of Knighthood of Sweden.

Jon Persson Staerck, on June 5, 1608, was made groom of the bedchamber by King Charles IX, and on August 7, of the same year, equerry to the King. In 1611, at the head of a company, acting without special order, he drove the Danes out of Skara and out of Sweden. For this he was highly praised by Gustavus Adolphus II, receiving title and deed to the Castle of Salis, Germany, afterward being granted Delstorp at Mitau for an eternal possession, also becoming captain of a company of horsemen. He received from the same monarch the promise of a diploma of nobility, but because of the illness of the recipient of this honor, it was not granted until his death. This diploma was dated August 12, 1632, and was confirmed by the royal authorities. He married a daughter of Christopher Goeranssen and had children, one Johann, who was first called Von Storch, and four others, one Isaac Jonsson, founder of the Swedish line of the name.

Through Johann, who married Elizabeth Hammerstein, the descent to Charles H. Von Storch is through Gustav, who married Anna Von Moising, and had children: Lucas Frederick, councillor of commissions; Johann Gustav, of whom further; Carl Frederick, councillor of ecclesiastical economy; and Christian Heinrich, a pastor.

Dr. Johann Gustav Von Storch, son of Gustav and Anna (Von Moising) Von Storch, was councillor and burgomaster of Guestrow, Mecklenburg, Germany, and grand duke of Mecklenburg-Schwering. He married Sophia Schoeppfer, among his five children being Christian Theodosius.

Christian Theodosius Von Storch, son of Dr. Johann and Sophia (Schoeppfer) Von Storch, was doctor and pastor at Lohman, Mecklenburg, Germany, and was twice married, the children of his first union, with Margaret Sophia Conradina Schoeppfer, founding the Russian family of Von Storch, while Heinrich Ludwig Christopher Von Storch was a child by his marriage with Anna Sophia Conradina Von Wick, and the founder of the family in the United States, represented in the city of Scranton by Charles H. Von Storch attorney, financier, and public servant.

Heinrich Ludwig Christopher Von Storch was born in Lohman, Mecklenburg, Germany, in 1772, died in Scranton, Pennsylvania, April 10, 1826. He came to the United States in 1794, in the company of a countryman, as a fur hunter, and after following this occupation for a time purchased three hundred acres of land in what is now North Scranton. He afterward returned to Philadelphia, where he had landed upon immigrating to this country, soon coming once more to the Scranton district, marrying in Wilkes-Barre, Penn-

sylvania, Hannah Miner, daughter of William Searle, a settler from Connecticut. After his marriage he brought his bride to his log cabin on what is now the southeast side of Main avenue and Green Ridge street. Ludwig Von Storch was the proprietor of the first store opened in North Scranton, and after his death his wife and eldest son managed the farm and store. His wife was a woman of intellectual brilliance, possessing both business capacity and a knowledge of the law, and for many years prepared deeds and other legal papers for the neighborhood, her death occurring after she had been a widow for thirty-six years, May 14, 1862. Heinrich Ludwig Christopher and Hannah Miner (Searle) Von Storch were the parents of seven children: 1. Ferdinand, born December 4, 1810, died November 21, 1868; married January 17, 1873, Caroline, daughter of Sidney and Jane (La France) Slocum, and had issue. 2. Theodore, born May 19, 1812, died May 30, 1886; married, October 21, 1863, Josephine Deborah, daughter of Hiram and Orpha (Church) Barney, and had children. 3. Leopold, born May 8, 1814, died November 4, 1882; married, August 22, 1839, Julia Ann, daughter of Aaron and Anna D. Gregory, and had issue. 4. Ludwig, born April 28, 1816, died April 12, 1886. 5. William, born February 9, 1819. 6. Godfrey, of whom further. 7. Justus, born April 15, 1824, married, August 9, 1882, Serena, daughter of Leonard and Mary Ann Boice.

Godfrey Von Storch, son of Heinrich Ludwig Christopher and Hannah Miner (Searle) Von Storch, was born in Scranton, Pennsylvania, July 24, 1821, died December 3, 1887. When he was thirteen years of age his father's estate was divided between the mother and the seven sons, and in his youth he obtained employment upon the canal, working on the Lehigh for several seasons. He later engaged in farming, becoming owner of a saw-mill, afterward operating in coal, superintending the sinking of the Von Storch and Leggett's Creek shafts. Prospering in material matters, he found time for public service, and was several times elected burgess of Providence, for three years representing the second ward in the select council of Scranton. He married, at Providence, Pennsylvania, May 22, 1859, Mary, born in Exeter, Luzerne county, Pennsylvania, April 4, 1830, daughter of Nelson and Jane (Durlin) Rogers, and had children: Bell and Charles Henry, of whom further.

Charles Henry Von Storch, son of Godfrey and Mary (Rogers) Von Storch, was born in Scranton, Pennsylvania, March 13, 1863. After preparatory training in the public schools of Scranton and Merrill's private school he entered the University of Pennsylvania, leaving this institution in 1885, and two years later was admitted to the bar, having since been active in his profession in the city of Scranton. He has made an estimable record in legal circles, and at the present time is president of the Providence Bank. Among the public service that he has performed in his native city is twenty years as a member of the school board, several of which were passed as president, an office he now holds, having been last elected thereto in 1910. He has given to the city a business administration of school affairs, has devoted himself to his arduous duties with praiseworthy fidelity, and has raised the public school standard of Scranton to a plane worthy of a city of its standing. He is a citizen of unselfish instincts, has made for himself an enviable reputation in the place of his birth, and is universally recognized at his true worth, a lawyer of talent, a municipal executive of sterling principles, and a gentleman of the noblest instincts.

Mr. Von Storch married Carrie A., daughter of Frank and Harriet C. Mott, of Scranton, Pennsylvania, and has one son, Searle, born January 3, 1899. Carrie A. Von Storch died June 3, 1914.

## WILLIAM ROWLAND DAVIES, M. D.

Dr. William Rowland Davies, one of the prominent physicians of Pennsylvania, and a leader among his professional brothers in the state, comes of a family originally Welsh, and representative of the best type of that stalwart race, which has contributed to valuable an element to the composite citizenship of the United States. Small in numbers comparatively with the representations of many European countries here, the Welsh contingent in America is not less valuable, forming, as it does, a leaven of its own peculiar virtues for great capacity for labor, industry and strong moral sense.

(I) Dr. Davies' grandfather in the paternal line was John W. Davies, a native of Glamorganshire, Wales, where he was born probably in the first decade or two of the nineteenth century. This ancestor was the founder of the family in America. He was married to Magdalen Daniels, also a native of Glamorganshire, Wales, and the daughter of Morgan Daniels, who was born in Neath, in the same Welsh county in 1775. Morgan Daniels married Mary Gibbs in his native land, and in 1832 emigrated from there to the United States. He did not live a great while in his new home, however, his death occurring at Spring Brook, Pennsylvania, in 1846. Mr. Daniels was a prominent figure in both his native and adopted communities and was the father of nine children. When John W. Davies came to this country he settled in Carbondale, Pennsylvania, and there his eldest child, William J., was born.

(II) William J. Davies, father of Dr. Davies of this sketch, was born in the month of June, 1844, and as above stated, in Carbondale, Pennsylvania. As a boy he attended the Carbondale public schools, and later pursued a more advanced course at the Wyoming Seminary. Upon completing his studies he took up construction work, and has been employed during most of his life in railroad construction and on public works. He married Jemima A. Rowland, a native of Carbondale, daughter of Moses T. and Ann (Rogers) Rowland, of that place, where Mr. Rowland was a tailor at the time of the outbreak of the Civil War. They were from Llangesny, North Wales. The children born to William J. and Jemima A. (Rowland) Davies are as follows: Laura, who became Mrs. John B. Nicholas, of Hazelton, Pennsylvania; William Rowland, of this sketch; Esther, who is now a teacher in School No. 13, Scranton, Pennsylvania.

(III) Dr. William Rowland Davies, the second living child of William J. and Jemima A. (Rowland) Davies, was born November 2, 1875, at Pittston, Pennsylvania. He received the elementary portion of his education in the local public schools, but supplemented this with a course of study in the Keystone Academy at Factoryville, Pennsylvania, where he prepared himself for a collegiate course. It had been his intention from an early age to devote his life to the profession of medicine, and accordingly, after completing his preparatory work, he matriculated in the Medical School of the University of Pennsylvania in 1895. He graduated with the class of 1899, taking the degree of M. D. The summer following his graduation he spent as house surgeon in the Pittston Hospital. He opened an office at No. 221 South Main avenue, and has remained in that location ever since. He is a member of the County Medical Society, the State Medical Society and the American Medical Association. In these he has represented the county society in the state body, and was chosen by the latter to represent it in turn in the national organization. He is chairman of the public safety and legislative committees in the Lackawanna County Association. Besides these honorable and responsible posts, he serves on the staff of the West Side Hospital of Scranton, and is consulting physician of the Mid Valley Hospital. He is a member of the progressive

section of the Republican party. He is interested in music and art. He is a member of Peter Williamson Lodge, No. 323, F. and A. M., and Keystone Consistory.

Dr. Davies married, June 20, 1902, Helen Clara Bard, a native of Factoryville, Pennsylvania, where she was born. Mrs. Davies is a daughter of William W. and Alma (Newton) Bard, and a descendant of the old and distinguished New England family of that name. To Dr. and Mrs. Davies have been born three children, as follows: Frederick Bard, born January 12, 1905; Ralph William, born October 25, 1906; Mary Alma, born November 10, 1910. Dr. Davies and Mrs. Davies attend the First Baptist Church of Scranton. They are active in church work.

---

#### JOSEPH H. STEELL

In the death of Joseph H. Steell, late of Scranton, who for many years was an influential citizen of that city, where he was effective in promoting the business, social and moral advancement of the community, well known for his great ability and unflinching adherence to principle, his adopted city lost one of its most esteemed and honored members.

Mr. Steell was born in the village of St. Clair, Schuylkill county, Pennsylvania, December 2, 1846, died in Scranton, Pennsylvania, March 9, 1900, in the prime of life and when he had but reached the zenith of his powers. He grew to maturity and was educated in his native village, residing there until the year 1878, when he located in Scranton, in which city he spent the remainder of his days. He at once became a member of the firm of Beadle & Steell, which established and conducted an extensive grocery business on Lackawanna avenue, later the site of the Grand Central Hotel, which proved an exceedingly lucrative enterprise. Later the business was removed to the corner of Penn avenue and Center street, where they conducted successful operations until the general store firm of J. H. Steell & Company was organized, with offices in the Traders' Bank building in Scranton. This corporation, with Mr. Steell as manager, operated six stores at one time, located at various commanding points in the anthracite region, and the success achieved was due in a large degree to the sagacity, foresight and executive ability displayed by Mr. Steell in his management of affairs. In addition to this extensive business enterprise, he was an active and potent factor in various other large commercial and industrial concerns. He was actively and prominently identified with the Hillside Coal and Iron Company, his connection with this being the foundation upon which was built the Steell Store Company. He was numbered among the largest lumber operators in the Lackawanna Valley, connected with two of the most important corporations in that trade, and served for many years as president of the Allegheny Lumber Company, operating plants at Bellhaven, North Carolina, which were the very extensive dressing mills formerly owned and operated by the Bellhaven Lumber Company. He was among the incorporators of the Lackawanna Lumber Company of Scranton, of which he was also president, his tenure of office being noted for the utmost conservatism compatible with progressive ideas, which policy aided materially in the development and progress of the company. There were few enterprises of any magnitude in the city of Scranton in which he was not interested, in one capacity or another, and his counsel and advice was always eagerly sought and earnestly followed, it proving of great advantage in every case.

Mr. Steell displayed his love for his country by enlisting his services in its defence during the trying period of the Civil war, he being then but a lad of fifteen, but he faithfully performed the duties allotted to him as a mem-



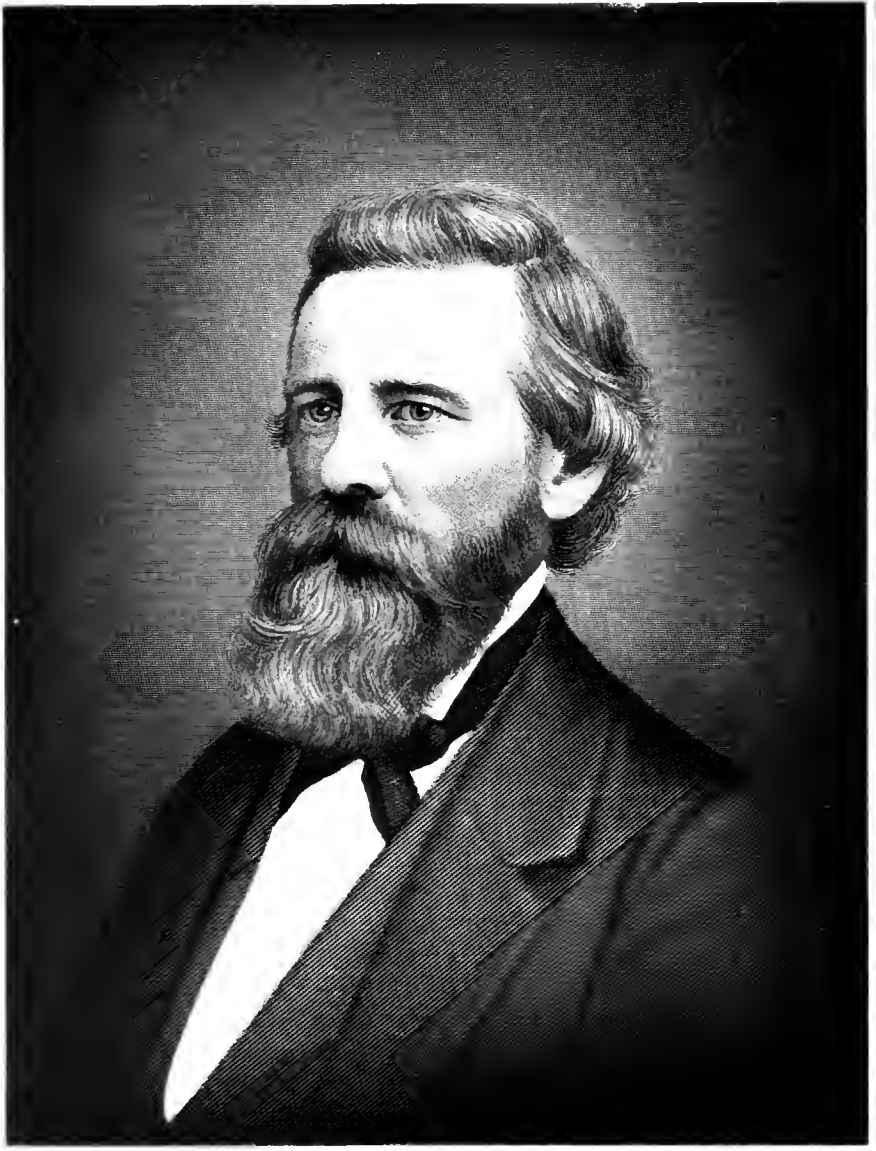

Miss Emily  
Robert Oakford



ber of the Pennsylvania Volunteers. He derived his greatest pleasure in the companionship of his family, which consisted of his wife, and four daughters: Nellie, Leila, Katherine, Ruth, to whom he was always most devoted, doing all in his power for their comfort and happiness, and to these his untimely demise was the greatest affliction that could befall them. His club membership was limited to the Scranton Club and the Country Club. Mr. Steell possessed all the attributes of a highly successful business man, ability, sagacity, perseverance and tact, and probably the greatest compliment that can be paid him is that he made himself an honor to the great commercial world, as well as a credit to the mercantile community in which he lived.

The directors of the Traders' Bank, in which Mr. Steell was a director, he numbering among its board of directors some of his most trusted personal friends, passed the following resolutions at the time of his death: "He was a man of excellent judgment, honest, upright, warm-hearted, and ever more willing to give than to receive. Many business institutions of the city will miss his wise and timely counsel." The directors of the Allegheny Lumber Company placed upon its records and before the public equally fervent tribute. "In the loss of our president we part with one who has been energetic, intelligent, and has shown great sagacity and good business judgment as the chief officer and manager of the affairs of this company. The business community also mourns the loss of one who has largely helped to mould and shape many successful business enterprises of this flourishing city." The same body, at the same time and in the same manner, touched a responsive chord in every heart in the community by its touching phrasing of the personal worth of the friend whom they mourned: "His private life was without blemish, and at the time of his death he enjoyed the confidence and respect of his business associates, neighbors and closest friends. We desire to express to the bereaved family our sorrow in the loss of a beloved husband and father, and commend them to Him who is the Father of the fatherless and the widow's God. Life is, as Prospero says: 'such stuff as dreams are made of, and our little life is rounded with a sleep.'"

---

#### LIEUTENANT-COLONEL JAMES W. OAKFORD

The ancestors of the Oakford family, represented in the present generation by Lieutenant-Colonel James W. Oakford, a prominent resident of Scranton, were among the earliest residents of the city of Philadelphia, and several of them were settled on the banks of the Delaware when William Penn first sailed up that river to the present site of Philadelphia. In the years when Philadelphia was the chief port of the New World, members of the family held prestige as leading merchants, being active factors in the growth and development of that flourishing city. Being of Quaker ancestry, they conformed to all the doctrines of that sect, leading peaceful and quiet lives.

Colonel Richard A. Oakford, son of Joseph Oakford, who was a prominent importer of china and tea, as was his father, Isaac Oakford, was born in Philadelphia, Pennsylvania, December 8, 1820. He attended the public schools of that city, and also studied at Lafayette College, Easton, Pennsylvania, where he specialized in languages, and studied German, French, Spanish and Italian, which he read with ease, and he spoke two of these languages fluently. He also studied engineering. Owing to failing health, he moved from Philadelphia to the Wyoming Valley. Later he was engaged in the coal business in Pittsburgh, Pennsylvania, and made extended trips down the Mississippi Valley as far as New Orleans, thus becoming acquainted with the southern viewpoint in regard to secession, slavery and likelihood of war. Because of this he

held a more exact and comprehensive idea of the attitude of that section than most northerners, not excepting those in authority. He realized that in the South there would be no compromise, and knowing well the position of the North, was prepared at any time for the announcement of war. At the outbreak of hostilities, at which time he was a resident of Scranton, he was among the first to volunteer for service, enlisting for three months, and was elected colonel of the Fifteenth Regiment, Pennsylvania Infantry. He was placed in command of the post at Camp Curtin, Harrisburg, named in honor of Governor Curtin, where the mobilization of the state troops was taking place, and when the regiment was ordered to the field, he commanded it in the Shenandoah Valley. On August 15, 1862, the One Hundred and Thirty-second Regiment Pennsylvania Volunteer Infantry was mustered into service, and he was chosen colonel. He was not destined to hold his new position long, for on September 17, 1862, while leading his men into the fray at the battle of Antietam, a bullet from the enemy's first volley found a vital spot in his body, killing him instantly. Although he had been in the service but a short time, he had found that place in the regard and respect of his fellow officers and the men of his regiment ever held by a true gentleman and a gallant soldier. In the official report of the battle forwarded to the War Department at Washington by Brigadier-General Kimball, the following notice of his death occurs: "Among the killed and wounded are many brave and gallant soldiers. Colonel Richard A. Oakford, 132nd Pennsylvania, was killed while leading his regiment." The fearless manner in which he went to his fate, and the able training he had given his regiment for service, were recognized in a set of resolutions drawn up by the commissioned officers of the regiment and presented to the family, testifying to his heroic action and paying tribute to him as a patriotic officer of unblemished reputation. That Colonel Oakford fully appreciated the awful danger of the engagement in which he lost his life, is shown in Colonel Hitchcock's history of the One Hundred and Thirty-second Pennsylvania in the war—"War from the Inside"—in which, concerning the eve of the battle of Antietam he writes, "I can never forget the quiet words of Colonel Oakford, as he inquired very particularly if my roster of the officers and men of the regiment was complete, for, said he with a smile, 'We shall not all be here tomorrow night.'" Then after a description of the events previous to Colonel Oakford's death, he continues, "He had been in command of the regiment a little more than a month, but during that brief time his work as a disciplinarian and drillmaster had made it possible for us to acquit ourselves as creditably as they all said we had done. General Kimball was loud in our praise and greatly lamented Colonel Oakford's death, whom he admired very much. He was a brave, able and accomplished officer and gentleman, and his loss to the regiment was irreparable. Had Colonel Oakford lived his record must have been brilliant and his promotion rapid, for very few volunteers had so quickly mastered the details of military tactics and routine. He was a thorough disciplinarian, an able tactician, and the interests and welfare of his men were constantly upon his heart." To the words of a comrade of those stirring times little can be added, except in regret that a life promising so much usefulness and service in the less violent paths of existence should be so sacrificed.

Colonel Oakford married, December 27, 1843, Frances Carey Slocum. By the marriage of Colonel Richard A. Oakford with Frances Carey Slocum, the English and Swedish blood of the Oakford family became allied with another strain of English origin. Members of the Slocum family have been connected with the history of Scranton since the day when it derived its name from them and was known as Slocum's Hollow. The records of the





J. W. Oakford.

town of Warwick, Rhode Island, contain the certificate of marriage of Johnathan Slocum and Ruth Tripp, on February 23, 1758, both of Portsmouth, Newport county, Rhode Island. In November, 1777, Jonathan Slocum settled on land in the Wyoming Valley purchased two years before. It was from his home in this valley that on November 2, 1778, his daughter, Frances, then about four years of age, was stolen and carried away into captivity by the Indians. The grief-crazed father was an implacable enemy of the Indians, and met his death in struggle with them in the battle which has come to be known in history as the Wyoming Massacre, fought July 3, 1778. Isaac Tripp, his father-in-law, was likewise killed at that time. The search for Frances Slocum was never abandoned and fifty-nine years later she was discovered with a tribe of Indians near Logansport, Indiana, by her brothers. She had been kindly treated, had married into the tribe, was the mother of several children, and was accorded far more consideration than the Indian squaws. The Indians, in deference to her superior intelligence, conferred with her on many matters, and she had instructed them in numerous useful arts, which had been her natural heritage. During her long stay with them, she had completely forgotten her native tongue and was compelled to converse with her brothers through an interpreter. Realizing that it was for her best good not to attempt to take her from what had become a congenial environment, they left her. Her death occurred near Peru, Wabash county, Indiana, March 23, 1847. William, son of Jonathan and Ruth (Tripp) Slocum, was born January 6, 1762, died in Pittston, Pennsylvania, October 20, 1810. From 1796 to 1799 he served as sheriff of Luzerne county. He married, June 4, 1786, Sarah L. Sawyer. Laton, the fourth child of William and Sarah L. Slocum, was born in Pittston, Pennsylvania, August 16, 1792, died January 16, 1833. He married Gratey, daughter of James Scoville, and it is through the marriage of his daughter, Frances Carey, that the lines of the Slocum and Oakford families meet.

Lieutenant-Colonel James W. Oakford, son of Colonel Richard A. and Frances Carey (Slocum) Oakford, was born in Scranton, Pennsylvania, June 5, 1859. After a preparatory education he matriculated at Yale College, whence he was graduated A. B., class of 1884. At the completion of his college course he entered upon the study of law, in the office of Judge Archbald. Upon the elevation of that gentleman to the bench, he was court clerk in the prothonotary's office and later continued to study in the office of S. B. Price, Esq., until his admission to the bar. He remained in Mr. Price's office for one more year after gaining the right to practice, and then established an office independently. While meeting with success in his chosen profession, he gradually acquired so many business interests that he gave less and less attention to legal matters. The chief of his varied interests are the Cherry River Boom & Lumber Company and the Hebard Cypress Company, both controlled by Scranton capital, holding the office of president in both. He is also a director of the Scranton Savings Bank and the Third National Bank.

With a love of military affairs inherited from a father who drank war's cup to the dregs, he has always been active in the Pennsylvania National Guard, and on two occasions has seen service at the call of the governor, once at Homestead and again at Hazleton. Before leaving home for college he was a member of the Scranton City Guard and continued in membership while away. Returning to Scranton, he became identified with the Thirteenth Regiment Pennsylvania National Guard, serving six years in the ranks, later as regimental quartermaster and commissary, and afterward as brigade judge advocate with the rank of major, and as division judge advocate ranking as lieutenant-colonel. His fraternal affiliation is with the Masonic Order, Peter Williamson;

Lodge, Free and Accepted Masons; Royal Arch Masons; and Coeur de Lion Commandery, Knights Templar. With his wife he is a member of the Episcopal church.

Lieutenant-Colonel Oakford married Mary, daughter of William Manness, of Scranton. Children: Frances Slocum and Mary.

---

CHARLES E. THOMSON, V. S., M. D., LL. B.

A learned physician and a skilled surgeon, Dr. Charles E. Thomson, is one of the most conspicuous figures in the medical and surgical profession in Scranton. Educated for his life work in the highest degree and with a practical experience gleaned from the most arduous of service, Dr. Thomson has identified himself with the Scranton Private Hospital as superintendent, and as the head of that institution gives to Scranton the fruits of his years of study and the reward of his wide and varied practice. Gives these to Scranton only in so far as Scranton is the seat of the hospital of which he has the honor to be the leader; in a fuller and truer sense, gives of his vast store of medical and surgical science for the relief of suffering humanity. Not only that, but through those whose instruction is received in the hospital, his influence and power is extended an hundred fold, reaching thousands of the maimed, sick and helpless, a mighty work of mercy.

Dr. Charles E. Thomson, son of Alexander and Mary (Vaugh) Thomson, was born in the Province of Ontario, Canada, October 23, 1859. He was educated in the provincial schools, later attending school at Canandaigua, New York. He then entered the Ontario Veterinary College, whence he was graduated in 1884 and for five years practiced as a veterinary. Impressed by the extent of this field and appealed to by the wider field of service in the curing of human ills and the alleviation of bodily pain, he decided to engage in the study of medicine and entered Bellevue Medical College, New York, graduating M. D. in the class of 1891. After receiving his degree he remained in the hospital for a period of six months, performing the duties of an interne, and here gained a fund of invaluable knowledge and experience. He was then offered the opportunity of accompanying a scientific expedition, sent out under the direction of the New York State Colonization Society of Liberia, as a physician. On this African trip he was by far the most necessary member of the party, as in the unaccustomed climate many of the men sickened with fever and for a time were in a very perilous condition. Dr. Thomson, however, although new to the practice, met with excellent success in combating the ravages of the fever and not one of the cases proved fatal. This was the first real test of his resourcefulness and ability, for without the numberless conveniences of an office and with inadequate supplies, the seriousness of the task and the responsibility for the health of his party would have appalled a man of less sturdy courage or with less self reliance. After the return of the scientific expedition and his release from further duty in that capacity he became an interne in the hospital for the cure of Ruptured and Crippled, in New York City, and after one year's service then came to Scranton in 1894, accepting the superintendency of the Moses Taylor Hospital. Upon the organization of the Scranton Private Hospital in that year, he was appointed its superintendent, an office for which he has proven himself eminently fitted and whose duties are discharged in the most thorough and able manner. To this hospital belongs the honor of establishing the first hospital training school in Scranton, its seal antedating that of the State Hospital. Dr. Thomson personally supervises the work of each department, his zeal in working for the continual improvement of the institution being responsible for the high stan-

dard that it has set up and maintains. Engaged in a noble work, much of the nobility of Dr. Thomson's character shows in his performance of his daily duties. The responsible head of a great organization, he so directs his co-workers that the results of their labors are blessings to their fellow-men, whose blessings, in return, come to those who relieve their pain and lessen their anguish.

In the pursuance of his policy of keeping abreast of the most modern movements in his profession, Dr. Thomson is an active member of the County and State Medical societies and American Medical Association. He also belongs to the Knights of Columbus, of Scranton. But perhaps the most wonderful achievement in the life of Dr. Thomson was his successful graduation from Columbia College in June, 1914, when he received the title of LL. B. He entered this college in 1911 and for the following three years attended lectures weekly, commuting between his home in Scranton and New York City, traveling in this time more than thirty-five thousand miles.

Dr. Thomson married Sarah, daughter of Richard Donnelly, of Ontario. Children: Marion, Charles C., Kenneth, Janett, Kelvin.

---

#### CHARLES HENWOOD

The life of Charles Henwood is a splendid example of the position of prestige and influence, honor and affection, to which sincerity, unimpeachable integrity and earnest effort will carry him who strictly adheres to them. He came of an old Cornish family, and represented that best type of Englishman which formed the great preponderance of our colonial population, and upon which, as on a sure foundation, the subsequent structure of American citizenship has been safely built.

His father, Charles P. Henwood, was employed in the English revenue service and in that capacity was obliged to move much about the coasts of England and Scotland, being stationed at various points thereon. His death occurred at Wellington, Somersetshire. Mr. Henwood married Sarah Kosking, a native of Penzance, Cornwall, and by her had two children, Charles, of whom further, and a daughter Elizabeth, who became Mrs. Scott Hammett, of Wellington, Somersetshire.

Charles Henwood was born May 28, 1846, at Penzance, Cornwall, England. He was educated in Ottery, St. Mary, Devonshire, and in William Corner's Academy. He used to accompany his father on the latter's various excursions about the United Kingdom, while still a lad, but in 1861, when he had reached the age of fifteen years, and completed his studies, he was apprenticed to a pharmacist, Thomas E. Hooker, who afterwards became well known in London as an electrician. Continuing in this service five years, Mr. Henwood, then a young man of twenty, removed to Bath, where his skill and knowledge of his subject soon won him an excellent position as an assistant pharmacist. Equipped as he was with theoretical and practical knowledge, there is no doubt that he might have had a successful career in his native land, but his ambitious nature continually urged him to explore fresh fields of endeavor, and it was not long before his attention was directed to the United States. Upon reaching his majority in 1867, Mr. Henwood set sail for America and upon arriving here settled in Scranton, Pennsylvania, which from that time on was to be his home. The first employment which he found was along the line of his former endeavors, with the firm of Matthews Brothers, pharmacists, with whom he continued for three years. By 1870, as a result of his constant industry and a worthy spirit of economy, he had amassed a considerable sum of money, sufficient to purchase the drug establishment of Rich-

ard J. Matthews on the corner of North Main avenue and Market street. This purchase was made January 1, 1870, and the enterprise thus begun was soon an assured success. His business grew rapidly and ere long had reached such large proportions that he found it convenient, if not necessary, to remove to larger and more appropriately located quarters at No. 1909 North Main avenue, where he continued until his death. In the year 1886 he admitted into partnership with himself his cousin, Sidney R. Henwood.

Despite the size of his business and the demands necessarily made by it upon his time and attention, Mr. Henwood did not confine his activities to his personal interests but gave generously of both to the general life of the city. He was keenly interested in all proposals looking toward the industrial development of Scranton, and an unusual clear sightedness and practical sense made his advice in such matters of great value and caused it to be eagerly sought. He was one of the most active of the organizers of the Scranton Woodworking Company, and held the position of treasurer of the concern for a number of years prior to his death. He was also a member of the Board of Trade and of the Druggists' Association, and in both wielded a large influence, born of his recognized integrity and worth. Always appealed to strongly by philanthropic causes, he was one of the supporters of the Young Men's Christian Association of Scranton, and was a charter member of the same. He was a very successful advocate in charitable work generally for he had earned the right to be regarded as a practical man and one unappealed to by chimerical schemes, and as such was the more readily listened to by business men generally. Indeed it may be said that many of the industrial propositions which he furthered were in his intentions philanthropic in part, for it was a favorite purpose of his to furnish legitimate means of occupation to the needy. Mr. Henwood was a modest and unassuming man, but of very strong convictions, and in a quiet way influenced not a little the community of which he was a member. In politics he was a staunch member of the Republican party, moulding his opinions not on questions of selfish interest, but upon his ideals of the highest civic duties, which he counted only less important than the obligations of religion. He was a man of deep religious sentiment and one of the most highly valued members of the Penn Avenue Baptist Church, serving for many years as deacon and giving generously of his means to its support. He was also much interested in the success of the North Main Baptist Church, a younger organization, and it was in a great measure due to the aid which he rendered it that this church was early placed upon a firm foundation and enabled to attain to its present useful ministry. It was in his home life, however, that Mr. Henwood's fine traits of character were perhaps the most beautifully displayed, and his affection and generosity formed for his family circle the true atmosphere of home.

Mr. Henwood was married in Glenwood, Pennsylvania, to Ada Hartley, a native of that place, and a daughter of James Hartley, of Scotch-Irish descent. To Mr. and Mrs. Henwood were born five children, as follows: Elizabeth May; Frederick, died at the age of eight years; Julia Alice; Charles Hartley; Ethel, who died in her fifth year.

Mr. Henwood's death occurred suddenly, February 22, 1902, in the fifty-sixth year of his age, and was universally deplored in the city which had so long been the scene of his active life, the community paying him the unusual honor of closing the places of business about the public square during the funeral services. The interment was made in the Forest Hill Cemetery.





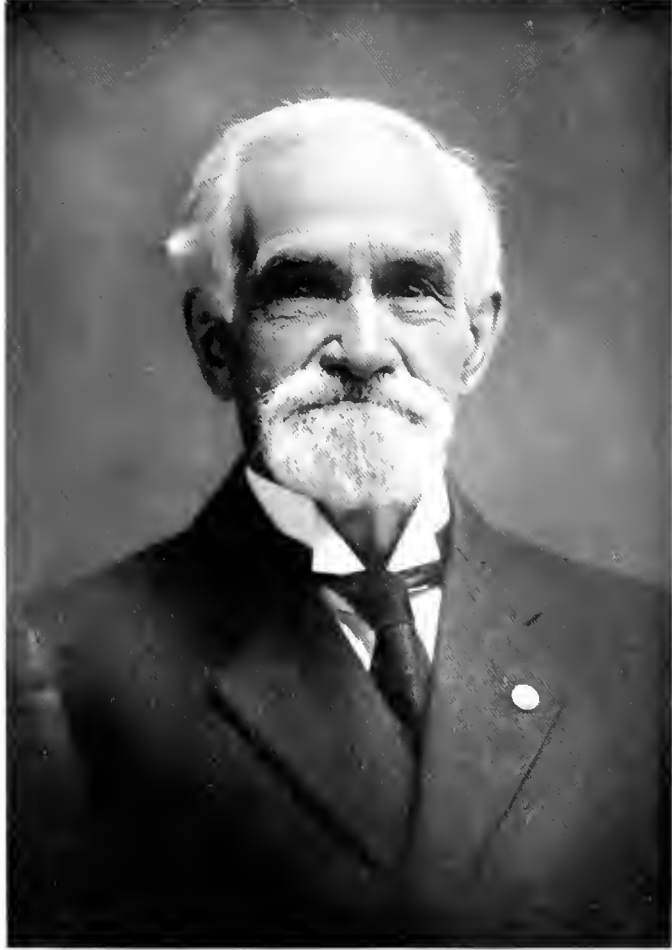

*S. M. Bunnell sr*

## LEWIS MARTIN BUNNELL

Lewis Martin Bunnell, who has achieved prominence as an attorney in Scranton and the adjoining country, represents a family which has attained distinction in this country and in England for many generations. He traces his ancestry to William La Bunnell, the Norman knight, who came to England with William the Conqueror in 1066. In this country the family was founded by William, Solomon and Benjamin Bunnell, who emigrated from England in 1638 and settled at New Haven, Connecticut. In 1790, when the first federal census was taken, representatives of this family were to be found in each of the thirteen original states. Historians speak of them as follows: "Being without exception men of character and piety, who used every opportunity to promote education and religion and were the first to adopt a written constitution and to refuse compensation for public service." The first four generations—(I) William, (II) Benjamin, (III) Benjamin, (IV) Solomon—lived in Connecticut. Solomon removed to Kingwood, New Jersey, in 1740, and to Pennsylvania in 1760, settling at Middle Smithfield, Bucks (now Monroe) county. Miles Bunnell, son of Solomon, and great-grandfather of Lewis M. Bunnell, was born in Norwich, Connecticut, and came to Pennsylvania, locating at a place called Auburn Corners. His son, Miles M., grandfather of Mr. Bunnell, was born in Danville, Connecticut, and also came to Auburn, Pennsylvania. Martin Bunnell, son of Miles M. Bunnell, was born in Danbury, Connecticut, December 11, 1800. He married Permelia Doud, from Connecticut also. They settled in Herrick township, Susquehanna county, coming there from Delaware county, New York, in 1827. Mr. Bunnell now owns the home farm. Martia and Permelia (Doud) Bunnell had nine children, five boys and four girls, of whom three boys and one girl are living in 1914, including Lewis M., mentioned below.

Lewis Martin Bunnell was born in Herrick township, Susquehanna county, Pennsylvania, December 8, 1835, and attended the public schools of his native township until he was fifteen years of age. In his sixteenth year he was sent to Herrick Center, where he was apprenticed to learn the trade of wagon building with Patrick McGunigal, but at the end of one year, went to Dundaff, and there assisted in a blacksmith's shop. He worked at Keene's Pond, near Honesdale, during the season of 1852, then returned to his home because of an accident to his father, and entered the employ of Captain James Giddings. Later he matriculated at Harford University, remaining there two years, and taught school two years, 1856-57, near Idlewild, then known as Long Pond. Kingston was his next abiding place, and there he studied elocution, Latin, etc., under Professor Nelson, after which he was again occupied as a blacksmith for one year, and then for a short time as an agent. He became principal of a school in Danbury, New Jersey, and upon his return to Susquehanna county, taught school there until April, 1859. The following month he went to Montrose, Pennsylvania, and there took up the study of law with R. B. Little, and was admitted to the bar of Susquehanna county, August 6, 1862, his studies having been interrupted by his military service, a detailed account of which is given below. Upon his return from the war he engaged in the practice of law in Montrose for one year, then traveled three years, after which he located in Scranton, where he has been actively identified with the legal profession since that time. He has had charge of much important litigation, and has been connected as attorney with many large estates, among these, acting as attorney to John Hernans, trustee of the estate of the late Joseph Fellows, a connection which existed sixteen years. Several millions of dollars were involved in this and some of the property consisted of coal

lands in and near the city of Scranton. From 1873 to 1876 Mr. Bunnell served as school director of Hyde Park, now a portion of the city of Scranton.

Mr. Bunnell married, January 1, 1866, Anna M., born in Newport, Oneida county, New York, a daughter of Richard R. and Elizabeth (Briggs) Davis, a native of Wales. Children: Mary R., Lewis M., Bessie A., Anna M. and Ralph Decatur.

The following record of the military service of Mr. Bunnell was compiled from official and authentic sources by The Soldiers and Sailors Historical and Benevolent Society:

"Lewis M. Bunnell enlisted from Susquehanna County, Pennsylvania, April 10, 1861, to serve three months, and was the first man to enlist from that county, in what was expected to become Company A, Twenty-fifth Regiment, Pennsylvania Volunteer Infantry, Colonel Henry L. Cake commanding, but this company was not mustered into service, Ringgold Light Artillery, one of the original five companies of the state having been substituted in its place, the regiment having gone forward, and his company was broken up. He, however, took the drill, and, as a camp follower, was with the regiment, without muster into service or pay until it was mustered out at Harrisburg, Pennsylvania, July 26, 1861, its term having expired.

"This was one of the first regiments to organize at the opening of the Civil War, Companies A, D, E, G and H, being the five original companies of the State, and engaged in barricading and guarding the Capitol until the arrival of the Massachusetts Sixth, and the New York Seventh, a period of about ten days. Companies A, B, C, E and H were on duty at the Arsenal, during the greater part of their service, and Companies D, F, G, I and K, moved, on June 15, to Rockville, reaching there next day. July 1, moved to Pooleville, and reported to General Charles P. Stone, commanding the Rockville expedition, thence via Point of Rocks to Sandy Hook, Williamsport and Martiusburg, where it was assigned to the Seventh Brigade, Third Division, of General Patterson's Army. On July 15, marched to Bunker Hill, thence to Charlestown and Harper's Ferry, where it remained until July 23, when it was ordered home for muster out of service.

"He re-enlisted, October 2, 1862, to serve nine months, and was mustered into service at Harrisburg, Pennsylvania, November 11, 1862, and commissioned captain of Company E, One Hundred and Seventy-seventh Regiment, Pennsylvania Volunteer Infantry, Colonel George B. Wiestling commanding.

"The companies composing this regiment were chiefly from the counties of Lycoming, Susquehanna, Dauphin, Luzerne, Perry and Indiana, and were organized at Camp Curtin, Harrisburg, during the months of October and November, 1862. A regimental organization was effected on November 20. On December 3, the regiment was ordered to Washington, District of Columbia, and proceeded thence to Newport News, Virginia, reporting to General Corcoran, where schools for officers were at once established and drill commenced. December 17 it was transferred to Suffolk, to the command of General Viele, and was assigned to the brigade of Colonel Alfred Gibbs on the east bank of the Nansmond River on the opposite side of which was a pine forest, which General Viele ordered to be cleared. Details from the One Hundred and Seventy-seventh were assigned to this duty, and although the growth of the timber was heavy and the labor very severe, by persistent and unceasing efforts a tract of several hundred acres was swept. At intervals of about ten days reconnaissances were made toward Blackwater, the enemy being met near Deserted House, seven miles south of Suffolk, where skirmishing commenced. On January 30, 1863, the entire force in and about Suffolk had gone on an expedition except the One Hundred and Seventy-seventh, and during the

absence of the forces, Colonel Wiestling was attacked by a body of rebel cavalry, which was handsomely repulsed. Upon the return of the expedition, General Corcoran with his staff, arriving after nightfall, attempted to pass the lines without the countersign, and nearly lost his life. On March 8, the regiment moved to Norfolk, thence to Deep Bottom, on the Albemarle and Chesapeake Canal, and here the regiment built a fort, also a stockade at Great Bridge, breaking up a notorious rebel mail route, capturing letters from the hems of dresses, hollow handles of umbrellas, hollow spokes and rails of carts and other vehicles. The command also took part in several expeditions, capturing a number of rebel schooners, steamers, stores and prisoners, performing valuable service, and was present at the battle of Gettysburg, Pennsylvania. On July 10, it was ordered to Washington, District of Columbia, and assigned to the Second Brigade, of Geary's Division, Twelfth Corps, Army of the Potomac, performing duty at Maryland Heights and other points until ordered home for muster out of service.

"The said Lewis M. Bunnell was appointed enrolling Marshall in 1862, at the time of the draft; enrolled the Township of Herrick previous to the said draft, and was elected either lieutenant or captain of such company which he drilled and returned again on recruiting duty. Between July 26, 1861, and October, 1862, at the request of Governor Andrew G. Curtin, he recruited six companies of infantry and one of cavalry. In February, 1863, Captain Bunnell was promoted to Brevet Major, and placed in command of four companies occupying an improvised tent on the Nansmond River. He was sick and disabled with camp fever and diarrhoea which resulted in hemorrhoids at the time of his discharge. He was sent with a command of one hundred and sixty infantry and cavalry about one hundred miles to Currituck, North Carolina, and had a skirmish with Walker's guerrillas. After leaving South Mills, North Carolina, moved four miles south to the Bay, sank two barges, destroyed four hundred bushels of salt, captured and paroled a number of prisoners, and upon his return had a severe encounter on the bridge with Bushwhackers, in which the Union forces were finally victorious. He received a final honorable discharge at Harrisburg, Pennsylvania, August 6, 1863, by reason of expiration of his term of service, and after his discharge recruited for the old regiment and spent three and one-half years in earnest effort for the Union cause."

He is a member of Griffin Post, No. 139, Department of Pennsylvania, G. A. R.; a member of the Union Veteran Union; was commander of the Department of Pennsylvania for three and one-half years; is a member of the Independent Order of Odd Fellows and the Knights of Pythias, and has held public office as a school director. His wife has ever been active as a friend of the Grand Army of the Republic; is a member of the Daughters of Rebekah.

---

#### LEONARD M. HORTON

Leonard M. Horton, secretary and treasurer of the Scranton Bolt and Nut Company, is a true son of Pennsylvania, the commonwealth having been the home of many of his line, most of whom resided in Bradford county. John M. Horton, father of Leonard M. Horton, was a follower of the shoemaker's trade and later conducted a hotel at what is now Terrytown, where he died at the early age of thirty-seven years. He married Susan L. Bacon.

Leonard M. Horton was born in Bradford county, Pennsylvania, June 30, 1854. He was but seven years of age when his father died and for the four following years he lived in Illinois. He then came to Harveyville, Luzerne county, Pennsylvania, and obtained his first position in a mercantile house,

remaining in the mercantile business until he came to Scranton in 1872, and began a long and honorable career in the office of the Moosic Powder Company, continuing for eighteen years. He was then connected with the Boies Steel Wheel Company for a period of seven years, then moving to Easton to become secretary of the Sterlingworth Railway Supply Company, remaining two years. He then assisted in the organization of the Scranton Bolt and Nut Company, in 1899, was elected a director and its secretary and treasurer, which position he has filled continuously ever since.

Mr. Horton has always been prominently affiliated with religious movements in Scranton. He is a member of the Immanuel Baptist Church, in which for many years he held the office of trustee, for fifteen years was treasurer, and for the past eighteen years has been a deacon, and is an ardent and devoted worker in all the interests of the church and its societies. He has served on the executive committee of the Scranton Baptist City Mission Society, in which organization his active co-operation has had a most desirable effect in furthering the projects of the society. To another branch of religious work which aims at the strengthening of the foundation of our nation, its young men, the Young Men's Christian Association, he has also given unsparingly of his time and labor, as well as of his means. For thirty-three years he was a member of the board of directors, and for ten years the watchful and faithful guardian of the association finances. He is still a participant in the magnificent undertakings of the Scranton branch as a member of the board of trustees, full of interest for and pride in the splendid organization of the city, as is his right, after the struggle to raise it to such a fair eminence, in which his part has been willingly borne. He holds membership in the Scranton Club and Scranton Board of Trade. His military connections have been confined to four years' service in the Scranton City Guard and four years as commissary of the Thirteenth Regiment Pennsylvania National Guard. He belongs to the Navy League, of which he has been a member since its organization. He is a member of the Pennsylvania Society of New York, and was one of the eight original charter members of the Scranton Bicycle Club.

Mr. Horton married Elizabeth, daughter of Lewis W. Keller, of Scranton. Children: Dickson M., associated with his father in the Scranton Bolt and Nut Company, and John M., an employee of the Lincoln Trust Company.

In the fifteen years of his membership of the officary of the company of which he is secretary and treasurer, Mr. Horton has filled his position in a most efficient and competent manner. Of high moral standard, identified with the best of the city's society, and of unimpeachable integrity, he is of the type that founded the city's greatness and insures it for the future.

---

#### SAMUEL HINES

Of distinguished Colonial ancestry, and of a family noted in the military history of his country, Samuel Hines, of Scranton, Pennsylvania, in his own person has been an important and conspicuous figure in the state for many years. His maternal great-grandfather, Daniel Carroll, was a member of the commission that met at Suters Tavern, Georgetown, March 30, 1791, when the proclamation directing commissioners to determine and lay out the boundaries of the District of Columbia was signed by George Washington, President of the United States, and Thomas Jefferson, Secretary of the State. Here also the commissioners, Thomas Johnson, David Stuart and Daniel Carroll, met September 9, 1791, and declared that the name of the national capital should be the "City of Washington." Mr. Hines paternal grandfather, John Hines, and a brother, Rudolph Hines, were soldiers of the Revolution, serving

in a Maryland regiment. His father, Philip Hines, with five of his brothers, served in the War of 1812. His brother, William Hines, was a soldier of the Mexican war; two brothers, Thomas and Daniel Hines, were soldiers in the Confederate army, and two others, William and George Hines, served in the Union army, during the Civil War.

Samuel Hines was born in Washington, District of Columbia, July 21, 1843, and was educated in the public schools of that city and at Union Academy, attending the latter institution, 1850-1858. In the latter year he commenced his remarkable business career as a clerk in the office of the commissioners of customs, serving until 1861, when he entered the military service of the United States as chief clerk to Colonel Henry B. Blood, deputy-quartermaster of the armies operating against Richmond, and continuing until 1865. In the following year he began his long and valuable service in Pennsylvania as paymaster, later as general agent of the Mercer Iron and Coal Company, and treasurer of the Jamestown and Franklin Railroad Company, covering the period 1866-1873. He then became intimately associated with the subsidiary companies of the New York, Lake Erie & Western Railroad Company in Pennsylvania, holding important positions in the following, between 1874-1896: President, superintendent and general manager of the Hillside Coal and Iron Company; Towanda Coal Company; Northwest Mining and Exchange Company; Blossburg Coal Company; director of the New York, Lake Erie & Western Railroad Company; Dagus Cabonda Railroad Company and Toby Creek Railroad Company. He was one of the organizers of the Erie & Wyoming Valley Railroad Company, and was a director in this from 1885 to 1890. He was one of the organizers of the Traders National Bank of Scranton, in 1889, was elected the first president, and was the incumbent of that office until 1896. This institution commenced doing business in January, 1890, with a directorate and board of officers composed of some of the most influential and representative men in the city. It was capitalized to the extent of two hundred and fifty thousand dollars, and with its conservative and farsighted management has become one of the most stable and leading of the city's numerous financial institutions. This result has been acquired in a great measure through the able offices of Samuel Hines, who enjoys and merits the confidence of the business and commercial circles generally. He follows closely the financial questions of the day, and is particularly conversant with the value and fluctuations of local securities.

While the services of Mr. Hines have been invaluable to the corporations mentioned above in every particular, there are one or two instances of personal influence that worked such great advantage to the Erie, that they deserve especial mention. In 1886 and 1887 suit brought by Dr. C. K. Earley, of Ridgway, Pennsylvania, was tried and decided by the Supreme Court of Pennsylvania against the Northwest Mining and Exchange Company (owned by the Erie Railroad Company) escheating to the state of Pennsylvania, bituminous coal lands belonging to the defendant company. The verdict in favor of the company was appealed from Elk county court to the Supreme Court of Pennsylvania, the attorney-general of the state being the appellant. The decision was affirmed by the Supreme Court, in terms that rendered it necessary to pass an act of legislature to enable the company to hold the lands against the escheat. There was strong opposition to the bill among the members of the house representing organized labor. At the request of the lawyers representing the Erie, Mr. Hines went to Harrisburg in the interest of the bill and through his friendship with Henry Hall, a member of the house, head of the Knights of Labor, and an old Scranton friend of Mr. Hines, he obtained a hearing. The result of his argument with Mr. Hall, lasting several hours,

was the withdrawal of opposition and passage of the bill that saved to the Erie coal lands valued at millions of dollars, for had the escheat held, it would have involved the other coal companies owned by the Erie.

Some years after the above occurrence, a general strike was ordered among the bituminous coal miners of the United States, which if carried into effect among the Erie miners would have entailed serious loss upon the company. At the earnest request of President King and Vice-President Felton, of the Erie, Mr. Hines assumed control of efforts to prevent a strike, using his great personal influence with the miners so successfully that the men refused to join the strikers and during the strike's duration the Erie mines were the only ones in operation in the district, their contracts were fulfilled, and their engines well supplied with fuel, while other railroads were greatly hampered and caused excessive extra expense. In carrying out his negotiations with the miners, frequently meetings were necessary at distant points, and for weeks Mr. Hines was continually on the road, making many trips by rail and wagon between the different mines, and keeping the strikers from influencing the loyal miners. On one of these trips in Bradford county, his team ran away, throwing him from the wagon and breaking his shoulder and also causing concussion of the brain. From this accident Mr. Hines has never fully recovered, both shoulder and nervous system still showing the effects of this strain.

The use of small anthracite coal by the Erie locomotives may also be attributed to Mr. Hines, they having an abundance of a size then unmarketable. A volume would not contain the record of Mr. Hines' valuable service, but another instance of his business ability must not be omitted. As president of the Hillside Coal and Iron Company, he drew up a lease in 1887 for anthracite coal lands to the company, that was duly executed, providing for a royalty based on the price of coal received by the company. In 1910 the lease was contested by its holders and suit involving six hundred thousand dollars, for that year, was begun. The case was tried in the county court and decided in favor of the Hillside Company, a new trial resulting from the same verdict. An appeal was taken to the Supreme Court of Pennsylvania, and the judgment of the lower court sustained. On a retrial by the Supreme Court, the same verdict was rendered, the lease being so perfectly drawn that no other verdict was possible under the law.

The standing of Mr. Hines in matters pertaining to mines and mining was so generally recognized that in 1883 and 1884 he was appointed chairman of the anthracite coal commission, formed to prepare an anthracite coal law for presentation to the legislature. In 1897 he became agent for the Price, Parker, Pancost and Throop estates, in Lackawanna county, and is now agent for the estates of Joseph Price, Eli K. Price and Dr. Benjamin H. Throop, Erie estates. Mr. Hines was one of the original members and first sergeant of Company D, Scranton City Guard, which was finally merged into the famous Thirteenth Regiment. He was elected second lieutenant, August 25, 1877; first lieutenant, November 15, 1878; captain, July 6, 1880.

While the foregoing would indicate a busy life, the social side of life has not been neglected nor the duties of a good citizen. Through the services of his patriotic ancestors he received the right of membership in the Sons of the American Revolution, a right he exercises, belonging to District of Columbia Chapter, his serial number being 1228 of the Chapter, and 24,376 of the National Society. He joined the Masonic fraternity in 1870, and is now past master of Lake Lodge, No. 434, having accepted this chair in 1873. He is a devoted churchman, and from 1875 to 1883 and again from 1902 to 1912, served as vestryman, senior warden and treasurer of St. Luke's Protestant Episcopal



Church of Scranton. In political faith he is a Democrat and influential in party councils. When the Democratic convention was in session in Scranton to nominate their candidates for the fifty-second congress, a committee was appointed to wait upon Mr. Hines and tender him the nomination, the convention taking a recess of one hour to wait for the report, although eloquently urged by the chairman, Frank Thompson, he would not accept the honor. He was then asked to make his choice for the position and responded, "Lemuel Ammerman," who was then in Europe. Upon the return of Mr. Ammerman to this country he at first refused to accept, but through the earnest entreaty of his friend, Mr. Hines, he finally accepted reluctantly. His opponent was Joseph A. Scranton, a very strong and popular man. An ante-election canvass near election day showed that if a change of a few hundred votes could be effected in the Carbondale district, the then lead of Mr. Scranton could be overcome. To this task Mr. Hines addressed himself with such good effect that his friend, Ammerman, for whose candidacy he was responsible, was elected, and served in the fifty-second congress, 1890-91. In the latter year the Democratic city convention tendered Mr. Hines the nomination for mayor of Scranton, but he declined this honor also, and suggested the name of Joseph Bailey, who was then nominated and elected. Thus loyal to his friends, and a tower of strength in their behalf in politics, as in everything, Mr. Hines seeks not his own advancement, but as a good citizen uses his best efforts to promote the public good. His long life has been one of honorable service and in whatever light he be viewed, the verdict must be "Well done, thou good and faithful servant."

Mr. Hines, married, in 1867, Rose Nolan, of Hamilton, Canada.

---

#### ERNEST GLOOR

A Swiss by birth, and intensely patriotic in his sentiment toward the homeland, Ernest Gloor, secretary and treasurer of the Gloor & Strubi Embroidery Company, has nevertheless to all outward signs and purposes completely transferred his allegiance to the land of his adoption, and in thought and feeling is as true an American as though his birthplace had been upon this side of the Atlantic. John Gloor, father of Ernest Gloor, was born in Leutwyl, Canton of Argovie, Switzerland, and was identified with the civil life of his native town for many years as town recorder. He married Elizabeth Rupp and had children: Frederick, died in Paris, France, in 1913; Gustavus, an employee of the Petersburg Silk Mills; Elise, married a Mr. Haggi, of Oftringer, Switzerland; Ernest, of whom further; Emma, died in 1910, married a Mr. Werder. The father of the above children died in the land of his birth in 1864.

Ernest Gloor, son of John and Elizabeth (Rupp) Gloor, was born in Leutwyl, Canton of Argovie, Switzerland, April 14, 1861, and for ten years was a student in the public schools of his birthplace, six years being spent in preparatory study for the high school course of four years. In 1882 he engaged passage on the steamer "Province," a French liner, and after an uneventful voyage landed at New York, proceeding directly to Philadelphia, where for two years he was employed by the Sauquoitt Silk Company. This company later transferred him to their mills at Scranton and he was identified with that company in this city until 1905. In the latter year he grasped an opportunity for the realization of a plan he had long cherished, the establishment of an independent business, and in partnership with Ernest Strubi, in March of that year, he opened a factory for the manufacture of embroideries. From its inception the project was an assured success and by 1908 its business had branched into such diverse channels that to facilitate the administration of the company's affairs incorporation papers were taken out, and the Gloor & Strubi

Embroidery Company took its place among the industries of Scranton, housed in a large store and ample factory at Nos. 533-537 Orchard street. The factory is equipped with the last word in embroidery manufacturing machinery, capable of turning out the finest and most delicate work, the annual output of the firm having a value of approximately one hundred and fifty thousand dollars. To Mr. Gloor is due a generous share of the credit that attached itself to the founding of a business and the introduction of an industry into a community where it was previously unknown, and a portion of like dimensions is deserved by Mr. Strubi, his partner in the venture. Mr. Gloor is a member of the Zion Lutheran Church on Mifflin avenue. He has taken an independent political stand, and belongs to the Scranton Gruetli Association, a Swiss patriotic organization, the Scranton Liederkrantz, and the German Alliance. He married Amelia Hungerbuhler, of Philadelphia, and is the father of one daughter, Amelia.

Ernest Strubi, one of the founders of the firm of Gloor & Strubi, is the only son of George Strubi, a life-long resident of Switzerland, his birth-place, and was born at Degersheim, St. Gall, Switzerland, in 1873. He was educated in the public and high school of St. Gall, and in 1904 immigrated to the United States, the following year becoming a member of the partnership alluded to above. He and Mr. Gloor have ever worked in frictionless sympathy for the advancement of their mutual interest, to the effect that they are the owners of a profitable business, a structure, the work of their own hands. Mr. Strubi is a member of the Junger Mannerchor, while his political convictions betray him to no party alliance. He married Anna Landeck.

---

#### EDWARD MERRIFIELD

For fifty-nine years a lawyer of Pennsylvania, most of that time passed in the city of Scranton, Edward Merrifield has in that time achieved brilliant success and has been accorded abundant honor. It has been thirty years since he began to loosen, one by one, the ties of his profession, gradually withdrawing from active practice, and even now, when he has passed the four score mark in years, his abandonment thereof is not complete. He is venerated by the members of his profession, and particularly by those who were at the bar when his activities were at their height, as a lawyer who has ever remained true to the code of honor that embodies lofty principles, as a gentleman whose consideration of the rights and feelings of others has made his life gentle and full of virtue, and as a man who in the service of a client or of the public, whatever his remuneration or reward, has fulfilled every obligation and has satisfied every trust. Not one of his many talents has been wasted, and from each there has come benefit to the cause of right and justice, of which he is an unfaltering champion.

Edward Merrifield was born at Hyde Park, Scranton, July 30, 1832. He began his studies in the public schools, later becoming a student in Wyoming Seminary, whence he was graduated in 1849, completing his academic studies at Oxford Academy, of New York. In 1852 he entered the law school presided over by Judge MacCartney, of Easton, and the following year became a student at law in the office of Harrison Wright, of Wilkes-Barre, Pennsylvania. In 1855 Mr. Merrifield was admitted to practice at the bar of Luzerne county, in that year opening an office and beginning practice in Hyde Park, six years later transferring his activities to Scranton, with which city he has been since prominently identified in legal and political circles.

As he attained prominent and honorable position at the bar through the exercise of legal ability of unusual worth, proving his strength as an attorney





David B. Hand, M.D.

in contest with the leading lawyers of the region, so, through devoted and efficient service, he gained like station in political circles. As a Democrat, in 1870 he was nominated for the office of recorder of the mayor's court of Scranton, and in 1884 for judge of the court of common pleas of Lackawanna county, and in 1894 was the choice of his party for Congress, a similar honor being conferred upon him in 1896. In 1878 Mr. Merrifield was the author of the new county bill, and was appointed to use his efforts and influence to secure the passage of the bill. Journeying to Harrisburg, in order that he might the more closely watch the deliberations of the state legislature, he there worked valiantly that the proposed legislation might be accomplished, but it was not until six years later that the bill he had drawn up became a law. This was Mr. Merrifield's second victory in securing the possibility of a new county, as in 1873 he had been deputized to attend the constitutional convention to advocate a change in the constitution in regard to the creation of new counties upon which the convention took favorable action.

Mr. Merrifield's services were again required when the people of Scranton desired the establishment of a United States district court in this city, and he was delegated to present the plea of the people to the Congress of the United States, assembled at the Capitol. Proof of the success of his mission is the district court that has since sat at Scranton. Thus might the story of the projects he has guided to a successful consummation, of his achievements at the bar, and of his invaluable public service, continue at great length, but it is sufficient here to repeat that failure has been recorded against him only when he has been confronted by impossibilities and that, having accepted a trust, he remains faithful until the complete fulfillment of its terms. For a number of years he was vice-president of the Lackawanna Institute of History and Science, and since March, 1914, Mr. Merrifield has filled the office of president, to which he was elected at that date. For years and since the death of Dr. E. Fisher he has been the acting president of The Animal Rescue League of Lackawanna county, a chartered institution for the prevention of cruelty to animals, to the duties of which he has given much time and attention.

Mr. Merrifield married, in November, 1855, A. Jennie Eldridge, of Owego, New York, and has one daughter, Jessie M., who married John H. Blackwood, of Los Angeles, California.

---

#### DAVID B. HAND, M. D.

While in his own person Dr. Hand, an eminent and representative physician of Scranton, is a most interesting personality, a study of his ancestry on both the paternal and maternal sides is also one of absorbing interest.

The ancestors on the paternal side came from England in the early part of the seventeenth century, settling in Connecticut and Rhode Island. Stephen Hand, the great-grandfather of Dr. Hand, was born in New Jersey, was the father of twenty children, and was a descendant of the Connecticut and Long Island family of Hand, mentioned elsewhere in this work. His son, Nathan Hand, born in Morris county, New Jersey, November 13, 1781, died in Cortland county, New York, aged sixty-four years. He married Margaret Crandelmeyer, born in Germany, was brought to New Jersey when five years of age, and died at Damascus, Wayne county, Pennsylvania, aged eighty-seven, at the home of her son, Nathan, who is living at the present time, aged ninety-six years. Her father died at the great age of one hundred years. Their son, Robert Hand, was born in Wantage, Sussex county, New Jersey, November 26, 1806, died in 1854. In 1831 he moved to Hawley, then a wilderness with but four or five houses, and purchased one hundred and eighty acres of valuable

timber land, cleared fifty acres, and erected a large dwelling. He then engaged extensively in lumbering, owning vast tracts of timber land, then of little value. The logs were rafted down the Lackawaxen and Delaware rivers to mills below. Later he erected saw mills, prospering in all his undertakings. His death was the result of fever contracted from exposure during a freshet, he being away from home at the time. He married, in New Milford, New Jersey, in 1827, Susan Goble, who bore him the following named children: 1. Nathan G., died in a Philadelphia hospital from disease contracted in the army. 2. Charles F., an engineer, died at the Wayne county homestead, aged thirty-three years. 3. Elizabeth L., married Dr. H. B. Stephen, and after becoming a widow she became noted as an evangelist and worker in the Women's Christian Temperance Union, being president of the county unions, state superintendent of Mothers' Work and state organizer. 4. Melissa A., whose first husband, Nelson Wilber, died from wounds received in battle while serving in the Union army. 5. William J., served as a member of Company E, Third Regiment Pennsylvania Reserve Corps, fought in thirteen battles, was twice wounded, and at Gaines Mills, June 27, 1862, was taken prisoner. 6. David B., of whom further. 7. Sarah A., aged four years when her father died; began teaching at fifteen years of age and continued until she was thirty; she labored in all departments of Women's Christian Temperance Union work and contributed largely to the educational work of that association of devoted women; she married, May 18, 1880, Jonathan Brown, of Lake Ariel.

The progenitor of the family in America on the maternal side was Stephen Roy, great-grandfather of Dr. Hand, who at the time of the great persecutions in Scotland migrated to America, settling at Valley Forge, Pennsylvania. He became a wealthy land owner there, and during the winter that General Washington's army was quartered at Valley Forge, he almost impoverished himself in his efforts to relieve their sufferings. In later years, when offered remuneration by the government, he refused to accept it, saying "My country's freedom is my reward." A daughter of Stephen Roy became the wife of Nathan Goble, born in Sussex county, New Jersey, where he was a farmer and stockman, and of this union a daughter, Susan, was born, who became the wife of Robert Hand, aforementioned. Mrs. Hand was a granddaughter of Francis Price, who served as judge of Sussex county for thirty-two years. She was also a niece of Governor Price, of New Jersey. Mrs. Hand was a remarkable woman, remarkable for her mental strength, noble traits of character, loving and lovable disposition, and true charity. Quoting from a lifelong friend and neighbor biographer under the caption "Life of a Truly Great Woman:" "How much may be bound up in life of a human being cannot be measured or appreciated. Influence can be traced for ages, but who shall drive the golden nail and say 'Here influence stops.' We are constrained to this remark when considering the life and work of Mrs. Susan Hand, of Hawley, Wayne County." "Mrs. Susan Hand's birth-place was in Sussex County, New Jersey. Through her veins flowed Scottish and French blood, and the history of her ancestors would sound like a page of romance from a master's hand. It would give a glimpse at a picture of contentment amid the streams and hills of 'Bonnie Scotland.' Then a scene of persecution would appear culminating in a flight for life from Scotland to the wilds of America." "Then as time passed on, we would catch a glimpse of Valley Forge, with its suffering and starving patriots. We would see her grandfather impoverishing himself, spending nearly his entire fortune in furnishing food and comfort to those who suffered so awfully in that memorable epoch of the American Revolution. We would hear the noble old patriot say proudly at the close of the war, when offered pay for what he had done, 'My country's freedom is sufficient pay.' Would that there were more such

spirit in these days of selfishness and political dishonesty." Mrs Susan Hand died September 17, 1891, aged eighty years.

Dr. David B. Hand, youngest son of Robert and Susan (Goble) Hand, was born in Hawley, Wayne county, Pennsylvania, March 31, 1848. He obtained a good public school education, and until he was sixteen years of age worked on the home farm, where he was for a time his mother's only assistant. He then began the study of medicine, impelled thereto as artists to paint or musicians to sing, and at once entered the office of Dr. George B. Curtis, who was pleased to say that he had a better knowledge of anatomy and physiology than half the doctors. He matriculated later in the medical department of the University of the City of New York, whence he was graduated, 1868, but being only twenty years of age the college would not grant him his degree of M. D. until he should attain legal age. He, however, began practice, locating at South Canaan, Wayne county, Pennsylvania, remaining there three years and a half, and laying the foundation for his reputation as one of the most skillful of physicians. He then located at Carbondale, where he continued in successful practice for seven years. Overwork now told on his health, and he was obliged to desist for a time. He sold his practice and for several months traveled in California and other western states, then returned to Pennsylvania, settling at Columbia. But he loved the mountains and valleys of the coal regions, and in the spring of 1880 he came to Scranton and there purchased the practice of Dr. Horace Ladd, one of the oldest physicians of the city who moved to Philadelphia, Dr. Hand succeeding him in practice and still continues.

Dr. Hand has always had a very large practice, and during his long life has been brought into contact with all forms of disease. His knowledge, skill, experience and successful treatment of baffling intricate cases have brought him into prominence in his profession, while in his special field of diseases of children he stands unrivaled. He loves children and perhaps no physician has labored more earnestly or effectively in their behalf. So he loves nature, animals and the soil. In gratification of this craving for nature and her works, he purchased a farm of one hundred acres at Waverly and there revels in fine stock and a model dairy. He began operations on the farm by thoroughly draining it, using eleven miles of tiling. In stocking it, he moved cautiously, making careful study of the different strains, finally deciding on Holstein. He purchased only registered cows, most of his herd being found in the "Advanced Registry." His young Holstein bull, "King Pontiac," the finest bred bull perhaps in the world, he purchased when six weeks old at a cost of three thousand dollars, his neighbors considering him raving mad to pay such a price for so young an animal. Dr. Hand and "King Pontiac" are familiar sights at the Lackawanna County Fair, where the latter is exhibited with great pride by his owner. The milk from his herd, about five hundred quarts daily, is sold to dairies, about one-third of it bottled, especially prepared for babies. The farm is Dr. Hand's greatest enjoyment and on it he has adopted every modern adjunct to successful dairy farming. His name is a familiar one all over the United States and Canada from his long connection with remedies, which he has placed upon the market for the alleviation of suffering and the cure of infant's troubles. Early in his professional career he discovered that he was very successful in treating children. He found certain remedies very effective and for years he labored to secure just the proper ingredients and proportions, then resigning from the medical societies to which he belonged, he placed these remedies on the market under the name "Dr. Hand's Remedies for Children." These covered the various diseases of the little ones and have always had a large sale.

In the business world, Dr. Hand holds a high position. He has aided largely in the development of Scranton along industrial lines and holds official relations with eighteen corporations of importance. He is also prominent in the fraternal world, belonging to Union Lodge, Free and Accepted Masons, of which he is past master; Lackawanna Chapter, Royal Arch Masons; Coeur de Lion Commandery, Knights Templar, of which he is a past eminent commander; Irem Temple, Nobles of the Mystic Shrine; to all bodies of Keystone Consistory, Ancient Accepted Scottish Rite, thirty-second degree, and to the Benevolent and Protective Order of Elks. In political faith he is a Republican, serving in Waverly as a member of council.

Dr. Hand married (first) in 1870, Sarah T. Cromwell, born May 2, 1851, in Hawley, daughter of James Cromwell, and granddaughter of Oliver Cromwell, who settled in Canterbury near Newburgh, New York. She was an earnest temperance worker, president of the Lackawanna County Women's Christian Temperance Union, and a devoted worker in the Methodist Episcopal Church. Mrs. Sarah T. (Cromwell) Hand died in 1903, aged fifty-two years. Children of this union: 1. Mary Isabella, died at Columbia, Pennsylvania, aged six years. 2. Fred Cromwell. 3. Elizabeth, married (first) Stephen F. Dunn, of Battle Creek, Michigan, deceased; married (second) Russell H. Dean, of Scranton; children of first marriage; David Hand Dunn and Stephen F. Dunn Jr. Children of second marriage: Goble Davis Dean and Howard D. Hand Dean, deceased. Dr. Hand married (second) Charlotte W. Wilcox, of Carbondale, Pennsylvania, daughter of Joseph N. and Adaline (Marshall) Wilcox. Joseph N. Wilcox came from England in 1874, settling in Carbondale. Mrs. Wilcox is a native of Carbondale. Mother of Joseph N. Wilcox whose maiden name was Newton was a direct descendant of Sir Isaac Newton. Mr. Wilcox is a mathematician which faculty comes naturally to him although never having taken up the study of mathematics.

This record of a useful active career is not complete, as Dr. Hand is hale and vigorous with many plans for the future that will no doubt be realized ere "Finis" is written on the volume of his life's deeds. He sprang from honored sires and in turn transmits to his posterity the record of a life spent largely in the service of humanity and one that from the time, when as a boy of thirteen, he stood by his honored mother's side, her strong support, down to the present hour has never known one dull, unprofitable hour.

---

#### CAPTAIN JAMES MOIR

A resident of Scranton since 1871, Captain James Moir has attained the highest civic honor the city can bestow, the office of mayor. In the military service of his adopted state he has also been honored, having for ten years prior to 1894 served as the regularly commissioned captain of Company C, Thirteenth Regiment Pennsylvania National Guard. He has also merited the confidence that for ten successive terms he was chosen by the voters of the Ninth Ward as their representative in councils. That such high civic and military preferment have been bestowed upon Captain Moir, can only be construed as a recognition of his worth as a citizen of his adopted city.

(I) Captain Moir descends from Scotch forebears, his grandfather, John M. Moir, having been a resident of one of the Orkney Islands, lying north of Scotland. His maternal grandfather was a native of Aberdeenshire, Scotland.

(II) John Moir, son of John M. Moir, was born in the Orkney Islands, and married Elspath Robertson, of Aberdeenshire. He spent many years of his life in the Saskatchewan region of Canada, in the employ of the Hudson Bay Company. He was there brought in contact with the Indians of that



region, spoke many of the tribe dialects and was always a friend of the Red Men. He finally returned to Scotland, where he died, leaving a family of seven children, of whom James was the eldest.

(III) The boyhood of Captain James Moir was spent in Scotland, but he was obliged to become a wage earner early in life. He went from Scotland to London, England, where he learned the tailor's trade and worked until 1867. In that year he came to the United States, locating in Philadelphia, Pennsylvania, where he remained until taking up his residence in Scranton in 1871. He there opened a merchant tailoring establishment on Lackawanna avenue and in time built up a business of large proportions. His military service began in 1877, he being one of the original members of the old Scranton City Guard, which later became Company C, Thirteenth Regiment Pennsylvania National Guard. He rose from the ranks, passing through successive promotions until in 1884 he was elected captain, serving in that rank two terms of five years each. At the expiration of his second term, in October, 1894, he received an honorable discharge. Captain Moir has always been a Republican and has been for many years a conspicuous figure in the public life of Scranton. He was elected mayor of Scranton in 1899, and during his administration the present City Hall was erected and his name is on the corner stone. His term as mayor was preceded by a long term in council, being president three years and also serving as chairman of the judiciary committee and a member of other important committees. At the expiration of his term as mayor in 1908 he was elected an alderman of the Ninth Ward, serving until 1913 when he was again elected to the same office and in which he is still serving. He attends the First Presbyterian Church. He is a member of the Caledonian Club and chief of this; a member of Peter Williamson Lodge, Free and Accepted Masons; a member of Keystone Consistory, Ancient Accepted Scottish Rite, holding the thirty-second degree; member of the Independent Order of Odd Fellows, Robert Burns Lodge, of which he is a charter member, and now has the forty-five year badge of this organization. He is past treasurer of the Encampment and a Patriarch Militant of the same order. He is also a knighted member of the Knights of Malta, Columbus Commandery; also a member of the B. P. O. E., of Scranton, No. 123, and has held various offices. Thus in business, military, civic and fraternal life, Captain Moir has actively borne his part and in the distribution of honors he has been awarded a generous share.

Captain Moir married, in London, England, Frances Flint, born in London, England; children: James S., John W., Helen, Robert B., Wallace W., Franklin, Wilfred, Flora, Elsie, Fannie. Robert B. Moir was a cadet at West Point Military Academy, appointed from Scranton, but in his second year was so badly poisoned by poison ivy that after three months he received an honorable discharge for disability. After his return home and recovery, he was appointed to a position on the city engineering staff, continuing in that position until his death in February, 1896.

---

#### WILLIAM LUTSEY HOUCK

William Lutsey Houck, of the firm of Houck & Benjamin, one of the most able of Scranton's many legal firms, is a member of a family long native to Pennsylvania, and since 1904 has made his residence in Scranton, that year also marking the formation of the above mentioned firm and its establishment in that city.

(I) He is a descendant of John Wesley Houck, born in Bushkill township, Northampton county, Pennsylvania, July 1, 1809, died in Columbia county, Pennsylvania, July 2, 1884. He spent his early years in the region of his

birthplace and when a young man came to Luzerne county in the pursuit of his trade, that of millwright. Later in life he abandoned that occupation and engaged in farming, continuing so until the infirmities of old age compelled his retirement from active participation in manual labor. This he was loth to do and in his latter years chafed under the enforced idleness caused by years, his whole life's creed being industry, from which he derived more genuine enjoyment than is obtained by most people engaged in nothing more strenuous than a hunt for pleasure. He was a Republican in politics, and a Methodist in religion, having been reared by parents of that faith and having united with that denomination in early youth. He married and was the father of five children: Julia, Sarah, Samuel, John, Florence Elizabeth, the third and last named now deceased.

(II) Samuel Houck, son of John Wesley Houck, and father of William Lutsey Houck, was born in Luzerne county, Pennsylvania, June 6, 1838, died in Berwick, Columbia county, Pennsylvania, April 20, 1906. He was educated in the schools of his native county, and there resided until his thirtieth year, when he moved to Briar Creek township, Columbia county, buying a farm in that township and there living until 1904. In that year he sold his land and moved to Berwick, in the same county, there remaining until his death. He had prospered in his farming operations and after moving to Berwick lived retired. His religious beliefs were those of his father, and in all departments of the service of the Methodist Episcopal church he played a prominent part, contributing generously to its maintenance and varied beneficences. Education was a subject upon which he favored the most advanced views, and as a member of the school board of Briar Creek township he was ever progressively in favor of improved educational advantages for the children of the locality. In the cases of his sons he carried out his convictions and rejoiced in his ability to afford them all a college education. He married Huldah Jane Lutsey, born June 19, 1832, died September 26, 1906. She was a daughter of William Lutsey, a successful and prosperous farmer of Slocum township, Luzerne county, Pennsylvania, who was a grandson of John Lutsey, the pioneer of the name in Pennsylvania, who came thither from Connecticut soon after the close of the war for independence. Samuel and Huldah Jane Houck were the parents of Ulysses G., William Lutsey, of whom further; John W., Harry M.

(III) William Lutsey Houck was born in Slocum township, Luzerne county, Pennsylvania, November 11, 1871. He attended the public schools in his youth and was graduated from the Berwick High School in the class of 1887, holding first honors in his class and delivering the valedictory address. He then attended Dickinson Seminary, Williamsport, Pennsylvania, and upon his graduation from that institution held first honors in his course, class of 1892, and was awarded, as well, a special prize for excellence in psychology and the prize offered in oratory by the president of the Seminary. He then took up his residence on his father's farm in Briar Creek township for a time, and prior to entering law school he taught school, being vice-principal of the Berwick schools in 1897 and 1898 and for the two following years principal of the schools of Freeland, Pennsylvania. In 1901 he entered the Dickinson School of Law, at Carlisle, Pennsylvania, whence he was graduated in 1904. As in his earlier school days, he displayed high proficiency in his studies, and was awarded prizes in Real Property, Evidence, and Constitutional Law, which augured well for his success when he should begin practice. This he did in the year of his graduation from Dickinson, receiving his credentials of admission to the Lackawanna county bar in the same year. In October, 1904, he formed a partnership with Frank P. Benjamin, as be-

fore stated, and this connection continues to the present time, to the mutual satisfaction and benefit of those most vitally concerned. The offices of the firm are in the Miller Building, Scranton, and here they have attracted a clientele among the most desirable legal patrons in the city. The early liking for legal procedure which Mr. Houck displayed during his college days has ripened into a more mature respect for his profession. Nor was the prophecy of his earlier days false, for in the nine years of his active career he has performed much legal work of merit, which has been characterized by the thoroughness of its preparation and the minute knowledge of the law shown. With his no less able partner, he has raised the firm of Houck & Benjamin to a position of place among others of longer standing and has proved himself no mean adversary in a legal contest. Mr. Houck is a Republican in political action, and fraternally affiliates with Knapp Lodge, No. 462, F. and A. M., Berwick, Pennsylvania, of which he is past master.

Mr. Houck married, in Carlisle, Pennsylvania, October 28, 1908, Katherine May Klink. With his wife he is a member of the Green Ridge Presbyterian Church.

---

#### FENWICK L. PECK

The line of American descent of Fenwick L. Peck, of Scranton, is from Joseph Peck, who came to Hingham, Massachusetts, in 1638, from Hingham, England, with three sons, a daughter, two men servants and three maid servants. He was representative to the general court, 1639-42, removed to Rehoboth in 1645 and there died December 22, 1663.

(II) Simon Peck, son of Joseph Peck, born in England, was a glazier by trade, lived in Dorchester, Massachusetts, where he served as selectman in 1667. He married (first) Hannah Farnsworth, (second) Prudence Clapp.

(III) Samuel Peck, son of Simon Peck and his second wife, was born April 20, 1667, settled in Mendon, Massachusetts, where he died September 6, 1725. He belonged for many years to the Presbyterian church. His first wife, Sarah (Wilson) Peck, born June 20, 1702, married, December 31, 1810, died July 17, 1842, leaving several children.

(IV) Jonathan Wilson Peck, son of Samuel and Sarah (Wilson) Peck, was born in Franklin county, Massachusetts, July 9, 1826, died in Scranton, Pennsylvania, October 14, 1895. When but a lad his parents settled in that, then unbroken, section of Pennsylvania, which later became Peckville, named in honor of Samuel Peck. Jonathan W. Peck engaged in lumbering with his father on arriving at a suitable age, and became a most influential and prominent man in his section. He was keenly active to the unusual opportunities offered at that time and was foremost in the development of Peckville, establishing and supporting the various financial and industrial companies there organized. Capable business man that he was, he did not rise at the expense of others, but aided all who came under his observation. He is remembered in Peckville as most kindly-hearted and generous, one of his last kindnesses to the village being to present the Baptist congregation with a new parsonage, an unsolicited gift. Some ten years prior to his death he moved to Scranton, where he spent the closing period of his useful life in retirement. Mr. Peck married (first) Mercyette Hall, born in Abington, Luzerne county, Pennsylvania, August 26, 1834, died in 1874, daughter of Sheldon Hall. He married (second) Hattie A. Clapp, who survived him. Three of the children of Jonathan W. Peck yet survive: Fenwick L., of whom further; Edson S., of Scranton; Mary A., wife of Everett A. Bush, of Orange, New Jersey.

(V) Fenwick L. Peck, eldest son of Jonathan Wilson Peck and his first

wife, Mercycette (Hall) Peck, was born near what is now known as Elmhurst, Pennsylvania, September 18, 1854. His early life was spent in Peckville, where he obtained a public school education. He then entered Wyoming Seminary at Kingston, whence after a three years' course he was graduated, class of 1875. He was his father's assistant in his lumber business until he was twenty-two years of age, then was admitted to a partnership, the firm becoming J. W. Peck & Son, and continuing until 1886. During these years the younger man was in charge at the Dunning (now Elmhurst) tract where saw mills had been erected. His days were spent in the woods and mills, his evenings being devoted to accounts and correspondence of the firm. In 1880 the Dunning tract being exhausted, similar operations were begun at Springbrook, continuing there five years, making nine years the young man had spent at the two tracts. They were valuable years to him, aside from the pecuniary reward they brought. He had developed into the strong, sturdy, physical man and had gained an intimate knowledge of the value of standing timber, and an intimate and expert knowledge of lumber manufacture in its every detail. In about a year after the working out of the Springbrook tract, he discovered and after thoroughly investigating a tract of hemlock timber in Potter county, Pennsylvania, organized, with the aid of his father and some of the wealthy men of Scranton, the Lackawanna Lumber Company with \$200,000 capital. Jonathan W. Peck was chosen president of the company and Fenwick L. Peck, in whose ability perfect confidence was placed, was appointed general manager of all operations necessary to convert the timber into lumber and find for it a market. In 1887 the first saw mill was built at Mina, Mr. Peck making that town his residence. Later two mills were acquired on the Allegheny river, logs being supplied to them by raft. The capital stock of the company was increased in 1892 to \$750,000, additional timber lands being purchased and new mills erected. The annual output of the company rose to one hundred million feet of manufactured lumber. All through the panicky years from 1893, Mr. Peck continued his extensive operations and instead of the prophesied failure earned substantial dividends for his stockholders, a result speaking volumes for his courage and executive ability.

Later he was induced to purchase an interest in the J. J. Newman Lumber Company, operating in the yellow pine belt of the state of Mississippi. In order to thoroughly acquaint themselves with this property and the adjacent territory it became necessary for Mr. Peck and his associates to make a trip over the entire tract by team, the distance traveled being about one hundred and fifty miles. The capital stock of the Newman Company was increased and three hundred thousand acres of additional long leaf pine timber land purchased and large lumbering operations begun. In 1899 he assisted in organizing the Cherry River Boom and Lumber Company, capital \$1,000,000, and they purchased a large tract of spruce and hard wood timber, located in Pocahontas, Greenbrier, Nicholas and Webster counties, West Virginia. A large mill was built, but before operations were fairly begun the property was sold, the price offered being irresistible.

As the advantages of combination became apparent, Mr. Peck and his associates formed the plan of consolidating their interests into one corporation. In 1901 this plan was carried out by the formation of the United States Lumber Company, that corporation taking over both the Lackawanna Lumber Company and the J. J. Newman Company. The new company, with a capital of \$5,000,000, purchased additional lands and so expanded that their annual output reached two hundred and fifty million feet of manufactured lumber. At the head of this corporation was Fenwick L. Peck. He was eminently fitted for the head of such a company, and has successfully managed the field





*Mr. R. Lewis*

operations from its beginning and as the executive head, planned with a far-sightedness and courage that has brought important results. The operations in Mississippi, at the Hattiesburg mills, have been very extensive and the corporation successful.

Mr. Peck's activity in the lumber world naturally led him into other fields of progress. He became one of the organizers and large stockholders in the Mississippi Central Railroad Company and was elected president of that company. He was also led into the field of finance, becoming a director of the State Bank of Sumrall, Mississippi; director of the First National Bank of Commerce of Hattiesburg, Mississippi; director of the Guardian Trust Company of New York, and in his own city, Scranton, is a director of the Scranton Savings Bank and of the Dime Bank.

In other industrial fields he has also invested largely. He is vice-president and director of the Peck Lumber and Manufacturing Company; director of the Scranton Mills; director of the Scranton Textile Company and has interests in many others not necessarily of a minor character. He continues in addition to all these important interests, president of the United States Lumber Company, with its varied and important business that has not diminished with the lapse of time.

Scranton is Mr. Peck's home city and here at No. 545 Jefferson avenue, in that choice residential district, he erected a house that is remarkable in even this city of handsome residences. Nor have the demands of business taken away his enjoyment of the social side of life, nor his interest in his fellowmen, nor his thirst for knowledge of the world. He has visited Europe several times and has toured his own country many more. His early days in the woods bred in him a love of out-of-doors and he has seen a great many of nature's wonders everywhere. His clubs are the Country and Scranton of Scranton, and the Railroad Club of New York. Politically he is a Republican; in fraternal relations a Mason, holding membership in Lodge, Chapter and Commandery.

Mr. Peck married (first) November 20, 1881, Jessie V. Mott, who died in March, 1883, daughter of James Mott, of Flakeley, Pennsylvania. She left a daughter, Jessie Mott. He married (second) February 5, 1885, Mina V., daughter of William and Grace (Oliver) Pethick, of Wayne county, Pennsylvania. A daughter was also born of this marriage, Florence Louise, and a son, Charles Wilson, who died in infancy.

---

#### WILLIAM R. LEWIS

Wales, "the country of mountains and each mountain a mine," is the land claimed by William R. Lewis, of the law firm of Taylor & Lewis, as his birth-place. Wales has been the home of his family for many generations, his father, Reese J. Lewis, being the first of the line to leave his native country and to seek his fortunes in a newer and richer land. Reese J. Lewis was a miner and contractor in Carmarthenshire, Wales, and came to the United States in 1868. Attracted to Pennsylvania by the similarity of its topography with that of his home land, he settled in the mountains of north-eastern Pennsylvania, at Scranton. Here he engaged in mining and through his native habits of industry and thrift was able to save a large part of his income which he invested wisely and profitably, so that during the last ten years of his life he was freed from the cares of active participation in business. The customs of years, however, were too strong to be snapped at once and to occupy, partially, his time, he gave his various properties much of his personal care and supervision, seeing that they were kept in repair and attend-

ing to many of the smaller improvements himself. Both he and his wife were members of the Baptist church, in whose work he was very active. His death occurred in 1887, he having survived his wife, Ann (Jones) Lewis, by eighteen years. His children were: Joseph R., deceased; Mary, married William Lewis, of Scranton; Annie, widow of Daniel James, of Wilkes-Barre; Jennie, married Elias E. Evans, of Scranton; Katherine, married John J. Davis, of Scranton; William R., of whom further.

William R. Lewis was born in Carmarthenshire, Wales, February 26, 1876. He was but a year old when his parents brought him to the United States. He was educated at the Bloomsburg State Normal School, whence he was graduated in the class of 1886. For five years thereafter he held the position of deputy prothonotary under Thomas H. Dale, during that time reading law under Judge Gunster and afterwards under Judge Alfred Hand. He obtained admission to the bar in September, 1893, and in January of the year following formed the present partnership of Taylor & Lewis for general practice. In his chosen profession, Mr. Lewis has had gratifying success. One of the honors that came to him as a result of the standing he had attained among those versed in legal affairs, was the election as district attorney, an office he filled with conspicuous ability from 1901 to 1906. Aside from his public service he has been a potent factor in the success of his firm, which bears a reputation for integrity and fair dealing gained through the learning, uprightness and honor of the partners. Mr. Lewis' only business connection is with the Scranton Big Muddy Coal Mining Company, of which he is president. He is a director of the West Side Hospital, to whose affairs he gives a great deal of time and attention.

Mr. Lewis married Josephine, daughter of Joseph D. Doyd, of Scranton. Their children are: Mary, Ruth, Gertrude. Mr. Lewis' residence is at No. 614 North Main avenue, where he enjoys an ideal home life.

---

#### JOHN B. CORSER, M. D.

This family, whose name was spelled both Corser and Courser, was brought to America in 1635 by William Corser. The Corser family descending from this Puritan sire has proved a valuable one, contributing to the public service many military men and many who have served equally well in business and professional walks of life.

Dr. John B. Corser, of Scranton, descends from the New Hampshire branch founded by John Corser, born about 1678, who settled in Boscawen, New Hampshire, in the early settlement of that town. In April, 1776, "Articles of Association," including a declaration of independence antedating that issued by Congress in Philadelphia, July 4, 1776, were subscribed to by citizens of Boscawen and among the signers were David, John (1), John (2), John Jr., Asa, Nathan, Samuel and Thomas Corser. David (3), Asa and Jonathan Corser fought at the battle of Bennington; Asa and William Corser at Bunker Hill, while Samuel, John, Thomas and other Corsers were also in the service. Similar service has been rendered by Corsers in every war waged by this country.

John F. Corser, father of Dr. John B. Corser, came from New Hampshire, settling in Towanda, Pennsylvania, where he was a successful merchant for many years, moving to Scranton about the year 1900. He married Harriet E. Smith.

Dr. John B. Corser was born in Towanda, Pennsylvania, October 14, 1873. He was educated at Susquehanna Collegiate Institute, Towanda, then spent two years at Princeton University, but deciding upon the profession of



medicine he entered the medical department of the University of Pennsylvania, whence he was graduated M. D., class of 1898. He took post-graduate courses at Lackawanna Hospital, then for three and a half years engaged in general practice in Scranton. Deciding to make a specialty of diseases of the eye, ear, nose and throat, he made special preparation in hospitals in Philadelphia, Pennsylvania, and in Vienna, Austria, for eighteen months, then returned to Scranton and began his successful career as a specialist in the diseases named. He is oculist at the West Side Hospital and at the State Hospital, member of the Pennsylvania State and American Medical associations, and has been president of the Lackawanna County Medical Association. He is a director of the Lincoln Trust Company, but gives his profession his chief attention, study and best effort. He obtains relaxation from the exactions of his profession in the social and athletic features of the Scranton, Country and Bicycle clubs of Scranton.

Dr. Corser married Fannie G., daughter of Charles and Helen E. (Pierson) Laverty, of Elizabeth, New Jersey. Mrs. Laverty was a daughter of \_\_\_\_\_ Pierson, first president of the coal company. Children: John B., Helen Elizabeth, Anna Laverty and Dorothy Gildersleeve.

#### HENRY REED VANDEUSEN

The VanDeusens of "VanDeusen Manor," Great Barrington, Massachusetts, descend from Isaac (1) VanDeusen, "Rich Isaac," who was the son of Abraham and Jemima (Schoonhoven) VanDeusen and grandson of Matthew Abrahamsen VanDeursen, one of the five brothers who came to New Amsterdam (New York) about 1650. These brothers were sons of Abraham VanDeursen, a resident of Deursen, a small village in North Brabant, Netherlands, and of an old Dutch family. Matthew Abrahamsen VanDeursen lived in Albany, New York, from 1657 to 1700, and his son Abraham in Kingston and Albany. "Rich Isaac" VanDeusen remained in Kinderhook on the Hudson until May, 1735, then moved with his family to the Housatonic settlement, where he built a log house on the land of his father-in-law, Coonrod Burghardt, near the site of the manor-house erected a few years later. "Rich Isaac" acquired an estate of several hundred acres in the upper part of Great Barrington, some of it lying along the Housatonic river. This was known as "VanDensen Manor." He owned other lands in the neighborhood and his sons added largely to their inherited estates. The VanDeusens and the Burghardts were the largest land-holders in western Massachusetts, and the old manor-house, of Dutch architecture, built of wood and brick, stood for more than a century, the home of Isaac (1), Isaac (2) and Isaac (3), the first known as "Rich Isaac," the last as "Wise Isaac." After the death of the latter in 1831 the manor passed out of the family and speedily began to deteriorate. The main part was taken down in 1860, the wing having been removed at an earlier date. Not a vestige of the original building remains, and the stone gate-post is the sole memorial of the manor building.

"Rich Isaac" VanDeusen married, January 14, 1730, at Kinderhook, New York, Fische, daughter of Coonrod and Gesie (VanWie) Burghardt. His six sons all settled upon lands owned by their father, which he deeded to them in 1787. He acknowledged the deeds in 1787, but they were not recorded until after his death in 1796, at the age of ninety-three years. These sons, Abraham Coonrod, John, Matthew, Jacob, Isaac (2), were noted for their uncommon height, the tallest being six feet seven and one-half inches, the shortest, six feet two inches.

"Wise Isaac" VanDeusen, who afterward added an "I" as an initial, was

the eldest son of Isaac (2) and grandson of "Rich Isaac" VanDeusen. He was a man of high character, a staunch churchman, and a fine French scholar. He lived in Great Barrington until 1806, when he moved to Ohio, later to Louisiana, returning to Great Barrington in 1818. In 1829 he wrote a history of St. James Church. He inherited the manor-house from his father in 1816, and from 1818 until his death in 1831 made it his home.

Coonrod VanDeusen, second son of "Rich Isaac" VanDeusen, was born at Kinderhook, New York, February 4, 1735, died December 26, 1808, at the "old stone house" and was buried in Mahaimé Cemetery, Great Barrington. The "old stone house," built in 1771, stood on the east road to Housatonic at the western base of Monument Mountain, Coonrod receiving lands there from his father. He married, in 1763, Rachel Hollenbeck, and had by her several children.

John VanDeusen, third son of "Rich Isaac" VanDeusen, was born March 19, 1737, died January 13, 1820, and is buried in the Buel Cemetery, Canajoharie, New York. He lived in the brick house in Great Barrington, north of the family burial ground, on land given him by his father. He married, in June, 1762, Catherine Hollenbeck, who died August 4, 1789, and is buried in the VanDeusen burial ground.

John (2) VanDeusen, son of John (1) and Catherine (Hollenbeck) VanDeusen, was born in 1763. He married (second) January 28, 1796, Rhoda Tuller, of Egremont, Massachusetts, and had issue.

Henry VanDeusen, eldest son of John (2) and Rhoda (Tuller) VanDeusen, was born in Great Barrington, Massachusetts, in 1797, and spent his life as a farmer. He married Julia Ann Reed and had issue: George S., died in 1911; Henry Newton, of whom further; Albert, a minister of the Methodist Episcopal church; Sylvania, married J. Snyder, of Cherry Valley, New York.

Rev. Henry Newton VanDeusen, son of Henry and Julia Ann (Reed) VanDeusen, was born in Cherry Valley, New York, in 1836, and after an active, honorable life spent in the service of the Methodist Episcopal church is now living a retired life. He was a member of the Wyoming Conference and served many churches in both New York and Pennsylvania. He was educated at Cazenovia Seminary and the Methodist Biblical Institute, the latter now the theological department of Boston University. Rev. Henry N. VanDeusen married Mary Jane, daughter of James Porter, of English descent. On September 8, 1913, the aged couple celebrated their golden anniversary, amid the happy rejoicings of their many friends and relations. Children: Porter B., of Rochester, New York; Ellen G., married Frederick O. Spooner, of Syracuse, New York; Henry Reed, of whom further; Julia, married P. B. Genger.

Henry Reed VanDeusen, second son of Rev. Henry Newton and Mary Jane (Porter) VanDeusen, was born at Laurens, Otsego county, New York, June 2, 1872. He was educated in the public schools of the different towns to which his father's ministerial duties called him, and after preparatory courses entered Wesleyan University, Middletown, Connecticut, whence he was graduated A. B., class of 1894. After graduation he was instructor in Greek and Latin at Dickinson Seminary, at Williamsport, Pennsylvania. He studied law under John J. Reardon Esq., of Williamsport, later entering the University of Pennsylvania, whence he was graduated LL. B., class of 1899. In February, 1900, he located in Scranton and has since been there engaged in active practice of the law. He has served as assistant solicitor for the city and has a well-established practice. He is a member of the Scranton Club and the Scranton Bicycle Club, having been president of the latter for several terms. In political faith he is a Republican, and in religion a member of the Methodist Episcopal church.

Mr. VanDeusen married Jessie L., daughter of Edward J. Dimmick. Children: William, deceased; Lawrence Reed, born July 8, 1906; Henry Reed (2), born April 19, 1909.

---

#### CLARENCE D. SIMPSON

Prominence in the business world carries with it certain responsibilities that must be met. Among these are an upright life, and one free from everything but what would serve as an example of business probity to the young men who strive to emulate their successful elders. While Mr. Simpson is not an old man, his success in business life has brought him prominently into the public eye, and rendered him an object of interest to young men and it is to him they have often turned for example and advice. In following his business course, it reveals nothing but what has been accomplished in the most honorable manner, the secret of his life, not being hidden in mystery, can be attributed to hard work, great energy, laudable ambition, clean, upright living and wonderful executive ability.

(I) Mr. Simpson comes from an early Rhode Island family, his grandfather, Christopher Simpson, settling in Albany county, New York, during the early years of the nineteenth century. He was born in Rhode Island in 1781, there married his wife Dolly, born 1780, and soon afterward emigrated to New York State.

(II) William S. Simpson, son of Christopher and Dolly Simpson, was born in Rensselaerville, New York, April 2, 1825, died at his home in West Pittston, Pennsylvania, December 5, 1912, one of the best known and respected of men. After attending public schools until his sixteenth year, he became a carpenter's apprentice at Prattsville, New York, becoming an expert worker in wood. In after life he took great pride, not only in the constructive work in which he was engaged but in his personal skill as a workman, equaling that of his best men. He located in Carbondale, Pennsylvania, where he engaged in building operations. He supervised the erection of the tannery in the upper part of the borough, erected the tannery buildings at Brackney and also built many dwellings for the workmen at Brackneyville near Binghamton. His long connection with the Scranton district began in 1856 when he settled in Dunmore, engaging in general contracting and building. He superintended the construction there of many public buildings and residences, among them the old Dunmore Presbyterian Church and Dunmore Christian Church. He became interested in the construction of breakers, to him belonging the honor of erecting at Archbald for Eaton & Company (afterward Jones, Simpson & Company) the first coal breaker erected in the Lackawanna Valley. He continued a private contractor until 1861, when he was induced to accept the position of superintendent of construction with the Pennsylvania Coal Company, then having their headquarters at Pittston. This necessitated the removal of his residence to Pittston, and from that time until the close of his long and useful life that was his home. His work for the company covered extensive operations in the erection of breakers, trestles and colliery building in endless variety. This exacting position he filled to the perfect satisfaction of his company, retaining through all the years of his connection their confidence and respect. With his men he was ever the thoughtful employer and their friend. He was cheerful and optimistic, his morning greetings always pleasant and friendly. As he advanced in years he retained his youthful manners and ever enjoyed the companionship of the young, his home being a gathering place for old and young alike. At the age of seventy-two years he retired, having amassed a competency, living, therefore, some fifteen years to

enjoy it. He died in his eighty-eighth year, and though of rugged physique the ravages of time made themselves felt, his end coming not through any organic complaint, but was caused by the general wearing away of all his parts. In his death almost the last link was broken that bound the formative early days of Pittston with the present. That he had borne so prominent a part in the upbuilding of the section was ever to him a pleasant reminiscence, and surely none builded better or more wisely than he. He saw the little town of his adoption grow, expand and prosper until it took front rank among the cities of Northeastern Pennsylvania. He won to him many staunch friends, was one of the best known men of his section, having spent the greater part of his years, eighty-eight, in Northeastern Pennsylvania. His death, though expected, was deeply regretted and was received with many expressions of sorrow.

Mr. Simpson married (first) December 26, 1846, Catherine Brandow, of Prattsville, New York, who died in Dunmore, Pennsylvania, in 1854; he married (second) March 26, 1867, Mary Emmeline Whalen Rice, of Dunmore, who died in West Pittston, August 30, 1884; he married (third) January 12, 1887, Mary J. Price, of West Pittston, who survived him. In religious faith he was a devoted Methodist, serving the church in official capacity.

(III) Clarence D. Simpson, son of William S. and Catherine (Brandow) Simpson, was born at Carbondale, Pennsylvania, April 4, 1849. He attended the public schools of Dunmore and Pittston, beginning a wage earner's life when young as water boy for a gang of his father's carpenters. Advancing sufficiently in years he became clerk for the Butler Colliery Company at Pittston, remaining in that employ several years, constantly rising in rank, eventually becoming superintendent. He resigned this position and in Buffalo, New York, became western representative of C. A. Blake & Company, anthracite coal dealers. After nine years there he returned to Pittston, becoming superintendent of the Enterprise Colliery near Wilkes-Barre. About 1881, in association with C. M. Sanderson, he leased and opened the Pancoast Colliery, continuing its operation successfully about four years, when he sold his interest to his partner. He then joined forces with Thomas Watkins in leasing the Grasse Island Colliery. He was now successfully started in coal operations and in succession organized and operated with success the Northwest Coal Company, the Edgerton, Babylon, Mount Lookout, Harry E. and Forty Fort collieries, all later sold to the Temple Iron Company. In 1901 he organized the West End Coal Company, in which he has a large interest. Besides his large private interests, Mr. Simpson is a director of the International Text Book Company, the Cherry River Boom and Lumber Company, the Hebard Cypress Company and other corporate enterprises. He is a man of large affairs and controls a vast amount of capital, engaged in the industrial enterprises of Pennsylvania. While not a practical builder like his father, he is none the less a great constructor and much that is lasting and beneficial has arisen through his constructive ability. One of his enterprises, launched about 1897, was the New Mexico Railroad and Coal Company. Their 465 miles of railroad and their 25,000 acres of coal land was made possible by Scranton capital, Mr. Simpson aiding in the organization of the company and becoming chairman of the first board of directors.

Mr. Simpson is emphatically a man of business, but also enjoys the social side of life and the companionship of his fellow-men. He is a member of the Scranton and Country clubs, also of the Union League of New York City. He gave to the city the Catherine Simpson Young Girls' Home and the land for the Hahnemann Hospital and contributed a large portion of the capital to build the same.

Mr. Simpson married Katherine, daughter of George Perrin, of Pittston; who died in 1906, leaving a daughter, Clara, now wife of H. H. Brady.

There is much to be gained from a study of the two men whose careers are herein traced. Like his honored father, Mr. Simpson Jr., began at the foot of the ladder and like him also reached the topmost round, although in a different line of activity. Both were graduates of the stern school of necessity and the secret of their rise in life may be found in their tireless energy and upright lives.

---

### MICHAEL J. MARTIN

One of the most distinguished members of the bar of Pennsylvania is Michael J. Martin, whose family, on the paternal side, came originally from France, but during a residence of many years in Ireland became united with a family of that land, a combination which has more than once resulted in great talents and ability, the clear analytical powers of the French mind enlightening and in turn being informed by the imaginative and romantic spirit of their northern kin.

(I) The paternal grandfather of Mr. Martin also bore the name of Michael Martin and was born in France, being one of those members of his family who came from that country and settled in Ireland during the early part of the nineteenth century. It seems that the Martins were connected in some way with one of the many attempts of that period to restore independence to Ireland, which in this case actually reached the stage of an armed expedition, of both land and naval forces against England. However, the expedition came to naught, being defeated by the British force sent against them, and the Martins among others were obliged to seek refuge in Ireland. From this country they never returned, but after a while settled in that most picturesque region on the northwest coast of Ireland, Sligo county, near Sligo bay. From this region northward through Donegal was a favorite resort of many French fugitives, especially the Huguenots, so that it is likely that the Martins often looked upon the faces of their countrymen, a sight which could not have been wholly unwelcome, despite the difference in faith, for the Martins were Roman Catholics.

(II) Patrick Martin, the father of Michael J. Martin, and son of the Michael Martin just mentioned, was born in Sligo, Ireland, October 26, 1846, and there passed his boyhood and youth up to the time he was seventeen years of age. He was educated in the local public schools, and upon completing his studies emigrated to the United States, settling in the great coal region of the state of Pennsylvania. Here he found employment in the mines, and followed the occupation of miner for a number of years, but later in life took to farming, from which he gained lucrative returns, and in which he continued until his death, September 13, 1913. He married Margaret Sullivan, a daughter of Charles and Jane (Stanton) Sullivan, of Denville, New Jersey, where she was born May 12, 1848. To them were born ten children, as follows: Michael J., of whom further; Jane, now Mrs. Bagley, of Carbondale, Pennsylvania; John, now a resident of Moscow, Pennsylvania; Dr. Thomas P., a resident of Jermyn; Margaret, now Mrs. Eagan, of Jermyn; Frank, a resident of the same place; James; Katherine and William, all residents of Daleville, Pennsylvania. It was in Daleville, Pennsylvania, that Mr. Martin spent the latter years of his life, where he eventually met his death and where Mrs. Martin and the three youngest children still reside. Mr. and Mrs. Martin were members of the Roman Catholic church and in that faith reared their large family of children.

(III) Michael J. Martin, the eldest child of Patrick and Margaret (Sullivan) Martin, was born December 29, 1871, in Scranton, Pennsylvania, where his parents were then residing. When he was but two years old his parents removed from the city of Moscow, Pennsylvania, so that the earliest associations of childhood dwelling in his memory are with the latter place. He received the elementary portion of his education at the local public schools, and at the age of fifteen found employment as a clerk in a country store. He did not remain in this service for a great while, inclination and ability having destined him to a different sort of career. He entered the Wyoming Seminary at Kingston, Pennsylvania, to prepare for a college course, and having graduated from this institution in 1891 he matriculated soon after at Cornell University, Ithaca, New York, from which he graduated with the class of 1895. Returning then to Scranton, the city of his birth, he registered as a law student in Scranton, with Hon. Lemuel Amerman, and after reading law in his offices for the prescribed period, was admitted to the bar of Pennsylvania, February 22, 1896. Two years later, in 1898, he was admitted to practice before the Supreme Court of the state. From the outset Mr. Martin's career was assured. His practice was rapidly developed, and his handling of the important cases entrusted to him was such as to increase his reputation and bring him to the notice of litigants in all parts of the state. His services were in quarters to which talent and ability always find their way, and he became attorney for a number of large transportation and industrial corporations. On February 24, 1906, Mr. Martin was admitted to practice before the Supreme Court of the United States. Both the volume and the importance of his cases now increased, and he was one of the eminent counsel chosen to defend Judge Archbald at the time of that jurist's impeachment. He was one of those who defended Judge Archbald in the preliminary proceedings before the house of representatives, and in December, 1912, was admitted to the bar of the United States senate, sitting as a high court of Impeachment, and took part in that now famous trial. Mr. Martin, as a result of his brilliant record, not alone in this case, but in many others, only less important, is now regarded as one of the leaders of the bar both of the state and the nation. He is a member of the Lackawanna Law Library Association, of the Pennsylvania State Bar Association and the American Bar Association, member of the executive committee of the Pennsylvania State Bar Association and also holds membership on the committee of the American Bar Association.

Besides his chosen profession, his very obvious abilities have been in demand in other quarters, and he is a director of the Union National Bank of Scranton, and of several large mining companies. He is a member of the Republican party, but though an interested and intelligent observer of the great movements taking place in the political world of today, has never been tempted to take an active part in that department of public life, notwithstanding. He takes an active part in the social life of his community, and is a member of a number of organizations, such as the Scranton Club. One of Mr. Martin's chief interests lies in the delightful realm of horticulture, and he might be called a gentleman farmer on a large scale. He belongs to the Lackawanna County Horticultural Society, and to the Grange of Covington township, where he owns two farms, upon one of which is situated his delightful summer home, and where he engages extensively in the cultivation of fruit, having there over a thousand fruit trees of many varieties.

Mr. Martin married, November 6, 1906, Ellen Griffin, a daughter of Aaron and Sarah (McWade) Griffin, of Scranton. Mr. Griffin was a native of Scranton, where he held the office of superintendent for the Delaware, Lackawanna & Western Railroad. His death occurred in 1883 and he was survived

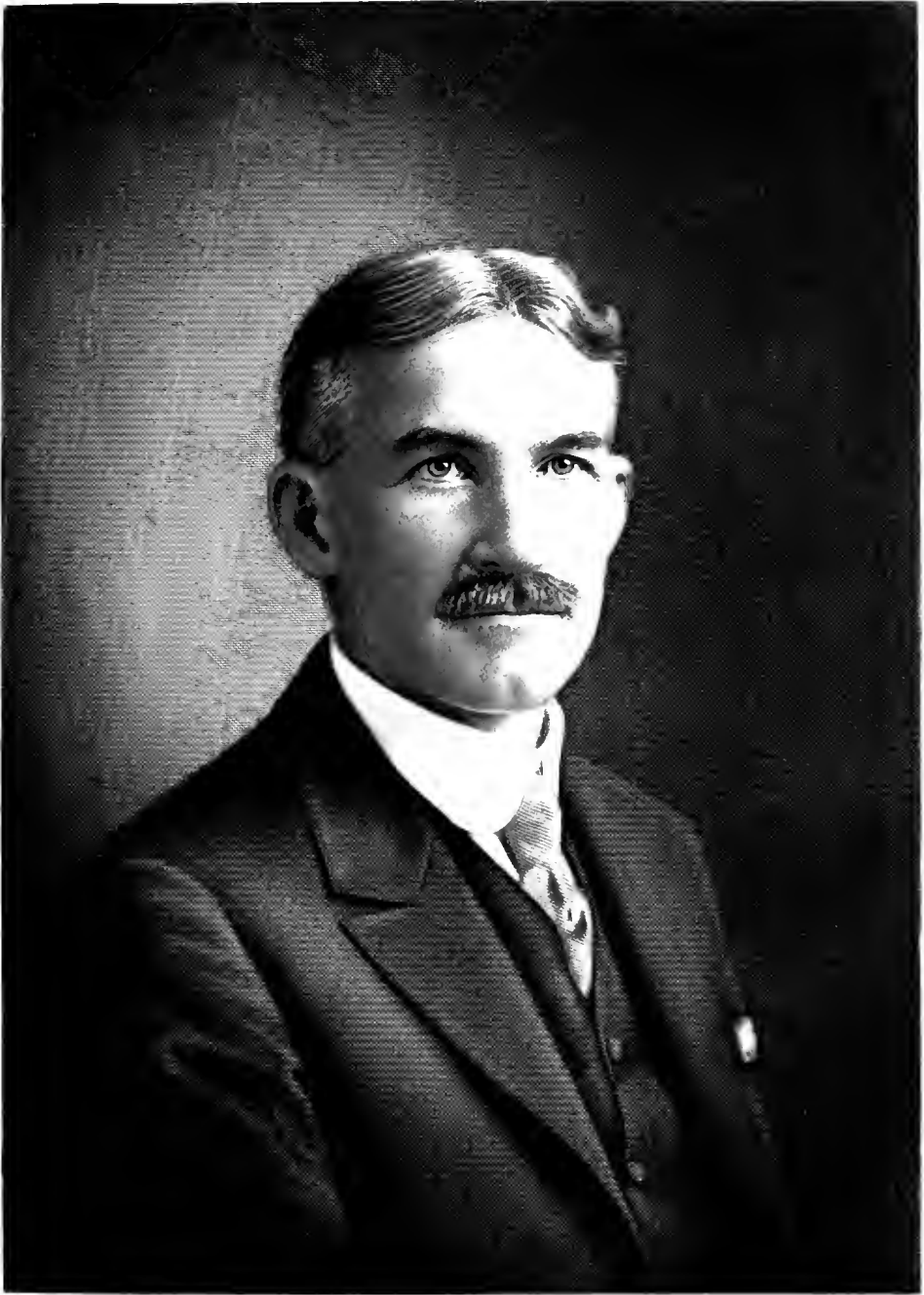

*W. H. Carter*





by Mrs. Griffin until January, 1911. By his wife, who was Miss Sarah McWade, a native of Covington township, Lackawanna county, Pennsylvania, he had three children, daughters, as follows: Ellen, now Mrs. Michael J. Martin; Grace, wife of Frank H. Jermyn; Elizabeth, wife of W. W. Lathrope. Mrs. Martin is a member of the First Presbyterian Church of Scranton.

---

#### COLONEL FREDERICK W. STILLWELL

Colonel Frederick W. Stillwell, who has made a most brilliant military record and enjoys wide acquaintance in the National Guard of Pennsylvania, among whom he is highly regarded for his fine soldierly qualities, was born in Scranton, June 14, 1865, a son of Captain Richard and Margaret (Snyder) Stillwell. His father was actively and intimately associated with that splendid group of pioneers—the Scrantons, Charles F. Mattes, William W. Manness, and others, who laid the foundations of the present greatness of the city of Scranton. Captain Stillwell also had an enviable military record. In his seventeenth year he enlisted in Captain Reeder's (Easton) company, and rose to the rank of orderly sergeant. In 1854 he organized the original Scranton Guard, was its first captain, and made it a notable organization. During the Civil war he served in the One Hundred and Thirty-second Pennsylvania Regiment, as captain, and participated in the battle of Antietam; and was of the forlorn hope which charged Mary's Heights, at Fredericksburg, in which he was so severely wounded that he was obliged to resign. After this he served as assistant provost marshal, and performed arduous service in enforcing various drafts for fresh troops, and in the apprehension of deserters. Besides his active professional career in connection with coal and iron industries, he gave to the city valuable services as chief of the fire department, member of the city council, and in other capacities. His wife was descended from General Peter Kichlein, who commanded a regiment of riflemen in the famous battle of Long Island (Brooklyn).

Colonel Frederick W. Stillwell, son of Captain Richard Stillwell, was educated in the Scranton schools, and at the age of sixteen became a messenger in the First National Bank. He acquitted himself with marked fidelity, and in 1893 was promoted to receiving teller, in which responsible position he has continued to the present time. He is also treasurer of the Wayne Development Company, and of the Pennsylvania, New York & New Jersey Power Company, which are developing a large power enterprise on the Wallenpaupack river in Wayne and Pike counties, Pennsylvania. The doctrine of heredity finds ample illustration in his military life. On January 12, 1885, at the age of twenty, he enlisted as a private in Company A, Thirteenth Regiment Pennsylvania National Guard, was promoted to corporal, July 5, 1886, to sergeant, January 22, 1888, and to second lieutenant, January 14, 1889. In 1892 Lieutenant Stillwell performed eighteen days duty with his company at the scene of the Homestead riots. He was promoted to captain, January 22, 1894, and to major, April 9, 1897, and with that rank performed duty for seventeen days in September of that year in the coal fields on the occasion of the Lattimer riots. At the outbreak of the Spanish-American war six companies of the Thirteenth Regiment, all of Scranton, volunteered for field service, and with them Major Stillwell. The regiment, under command of Colonel H. A. Courson, was mustered into the service of the United States at Camp Hastings, near Harrisburg, May 13, 1898, and from May 19 to August 30 was stationed at Camp Alger, Virginia. It was then ordered to Camp Meade, at Middletown, Pennsylvania, where Major Stillwell was promoted to lieutenant-colonel, October 21, same year. On November 14th the regiment was transferred to Camp Me-

Kenzie, at Augusta, Georgia, to make preparations for a campaign in Cuba. The war, however, came to an abrupt close, and Lieutenant-Colonel Stillwell was mustered out with the regiment, March 11, 1899. During its term of service the command suffered severely from disease, losing by death nineteen men. Twelve officers out of thirty-six were in hospital at the same time. Officers and men, whatever their disappointment in not being participants in the active operations in Cuba, had the proud satisfaction that comes from doing all that a soldier may—obey the call of country, and perform such service as demanded. The Thirteenth Regiment returned to its place in the National Guard establishment, Lieutenant-Colonel Stillwell retaining his rank therein. In 1902, during the coal strike, he served for forty days at Olyphant, taking the regiment to that point and commanding it until the arrival of Colonel L. A. Watres. Lieutenant-Colonel Stillwell was commissioned colonel, August 25, 1904, and still commands the regiment.

The foregoing presents an unusual record of service—long and honorable, without a tinge of personal vainglory. Colonel Stillwell takes a laudable pride in the splendid body of citizen soldiery with which he has so long been identified, and it is the concensus of opinion of both officers and men that its excellent condition and esprit de corps is in very large degree due to his military ability and the enthusiasm which he awakened and sustained. Within six months after he assumed command the regiment had attained such a degree of efficiency that it passed from ninth to third place among the regiments of the National Guard of Pennsylvania, and it now ranks first in efficiency, according to reports on file in the War Department. Of Colonel Stillwell personally, it is to be said that throughout his career his various promotions have been solely upon merit, and he holds his subordinates to the same lofty standard which at the beginning he set up for himself, and all appointments and promotions recommended by him are based only upon demonstrated ability and deservingness, his judgment uncolored by aught of a personal or political nature. With a well selected corps of officers, commissioned and non-commissioned, constituted through his unyielding adherence to these tenets, his ample technical knowledge and his strict disciplinarianism, the Thirteenth stands forth as a regiment not to be surpassed in the National Guard establishment of any state in the Union.

---

#### EDWIN C. AMERMAN

A graduate of Bucknell University and Dickinson College, from which latter institution he received the bachelor's degree in both arts and law, Edwin C. Amerman has been a legal practitioner in Scranton since his admission to the bar, his active work in the city covering a period of ten years. That this decade has been spent in nothing but diligent professional application is evidenced by his present legal status and the dimensions of the practice that he has acquired in that time.

Mr. Amerman is a native of Danville, Pennsylvania, his father, Jesse C., born at that place in 1821. Jesse C. Amerman was a farmer. He was twice elected to the Pennsylvania state legislature. He married Margaret Appleman, and had children: Charles V., of Danville, Pennsylvania; Edwin C., of whom further.

Edwin C. Amerman, son of Jesse C. and Margaret (Appleman) Amerman, was born November 20, 1878, and in his boyhood was a student in the public schools of his native place. After attending the Mansfield State Normal School he matriculated at Bucknell University, later entering Dickinson College and there completed the prescribed classical course and received the degree of A. B.

and then took up the study of law, being graduated LL. B. in 1904. On October 10, 1904, Mr. Amerman was admitted to the bar and immediately began the practice of his profession in Scranton, remaining in that city to the present time. He is now associated in the practice of law with George M. Maxey. Mr. Amerman has succeeded in his profession not only through natural talents that have been strong factors in his rise to prominence in legal affairs, but through his quick comprehension, easy adaptability, and intimate knowledge of the law. He has passed the period when books are his study, and derives much of his legal prowess from close scrutiny of men, motives and facts. At the bar he is a trained and fluent speaker, a forceful advocate, full of conviction, gaining the ear of his audience through his intense earnestness quite as much as through the plea he presents. Mr. Amerman is a thirty-second degree Mason, belonging in that society to Irem Temple, Nobles of the Mystic Shrine, of Wilkes-Barre, Pennsylvania, and also affiliates with the Benevolent and Protective Order of Elks. His political views are strongly Democratic, that being the party he has ever supported. He married Lillian, daughter of William Rechel, of Rupert, Pennsylvania, and has one daughter, Margaret.

---

#### I. RAYMOND VINCENT, M. D.

Dr. I. Raymond Vincent, one of the most successful of the rising generation of physicians of Scranton, is a member of a family of Scotch-Irish origin, and typical of the best character of that strong and dominant race, which has contributed so large and valuable an element to the make-up of the composite citizenship of this country, and impressed our people with no little share of their own hardy virtues of indomitable courage and practical sense. Of this race in the first place, the Vincents have nevertheless dwelt for so many generations in America, in that part comprised within the limits of Eastern Pennsylvania, that they have become completely identified with the life and traditions of that region.

The paternal grandfather of Dr. Vincent was Isaac Vincent, a native, himself, of Pennsylvania, and a life-long resident of that state, where he followed the occupation of farming with a high degree of success. He was a well known figure in his community. He married Phoebe Watson, of what is now known as Watson Town, named after her family. Her father and his three brothers were, indeed, the original settlers in and the founders of the place. They were pioneers in that region, making their way at that early date through what was virgin wilderness. Arriving at the site of the present Watson Town, they proceeded to clear the land, and built the first rough dwellings. Coming some years later to the spot, Isaac Vincent met and wed the daughter of one of these hardy pioneers, Phoebe Watson. To the couple were born five children, as follows: 1. George, the father of our subject. 2. Rebecca, who became the wife of Dr. J. L. Lowrie, of Winchester, Illinois, deceased; they had two children, Paulina and William. 3. Elizabeth, now Mrs. Frederick Van Fleet, and the mother of one son, Vincent. 4. Henry Clay, who married Bertie Opp; they had four children: Hazel, Fred, Dudley and Margaret. 5. Charles, now a resident of Boston, Massachusetts.

George Vincent, father of Dr. Vincent of this sketch, was born in Watson Town, where his father had settled some years previously, in the year 1852, and following in the elder man's footsteps he engaged in farming all his life. He was very successful in this and became a man of substance and a conspicuous figure in Watson Town and the surrounding country. His death occurred in 1904, at the age of fifty-two years. He was married to Laura B. McKaen, a native of Jacksonville, Pennsylvania, and a daughter of Samuel

McKaen of that place. To George and Laura B. (McKaen) Vincent were born five children, as follows: 1. Dr. I. Raymond, the subject of this sketch. 2. Elizabeth Lowry, now the wife of the Rev. B. F. Bieber, a clergyman of the Lutheran church, and the mother of one daughter, Laura Frances. 3. Phoebe Rebecca, resides at the home of her parents. 4. Lucy Bell. 5. William Mark.

Dr. I. Raymond Vincent, the eldest child of George and Laura B. (McKaen) Vincent, was born December 25, 1878, at Watson Town, Northumberland township, Pennsylvania. He received the elementary portion of his education in the public schools of Watson Town, and graduated from the high school there in the year 1896, having prepared himself for college. Upon completing his studies at these institutions, he matriculated at Bucknell College, Lewisburg, Pennsylvania, and graduated therefrom with the class of 1900, with the degree of Bachelor of Science. He then took up the profession of teaching, and for two years after his graduation occupied the post of instructor in the schools of Watson Town and the adjoining districts. In the meantime, however, the purpose had been growing in the young man's mind to devote his life and energies to the profession of medicine, to which he was strongly drawn by interest and inclination. Accordingly, at the end of the two years mentioned, he returned to his studies, this time matriculating at the Jefferson Medical College in Philadelphia. Here he set himself to the task of mastering the great subject he had chosen as his life work, with all his characteristic aptitude and zeal, distinguishing himself highly during the three years he remained in the institution, and graduated with the class of 1905, with the degree of M. D. He was twenty-seven years of age at the time of his graduation, but instead of immediately beginning his active practice, he spent six months at Wolmesdorf, Pennsylvania, and the following six months in the employ of the Great Lakes Coal Company, at Taylor, Pennsylvania. On June 18, 1906, Dr. Vincent came to Scranton, Pennsylvania, and there established himself in the medical practice which has steadily developed since that time. It is beyond doubt that his choice of medicine as a career was a wise one on the part of Dr. Vincent. His practice is demonstrating his ability, not only to his own clientele, but to his colleagues throughout the region. He is a member of the Lackawanna County Medical Society, and the State Medical Association. He is also a member of Peter Williamson Lodge, No. 328, F. and A. M.; of Keystone Consistory, Sovereign Princes of the Royal Secret; Irem Temple, Nobles of the Mystic Shrine, and of the Temple Club. He is a member of the Republican party, and takes a keen interest in all political questions, whether the issues involve merely local or larger considerations, and is an intelligent observer of local politics, albeit his duties preclude any participation in them on his part. His religious affiliations are with the Presbyterian church, and he attends the Second Church of that denomination in Scranton. He is active in so far as his professional duties permit, in the work of the church, and materially supports the many benevolences in connection therewith.

Dr. Vincent married (first) Kate G. Dunkel, a daughter of Hiram Dunkel, of Watson Town, where she was born. This marriage took place on September 26, 1906. Mrs. Vincent died August 25, 1908. Dr. Vincent married (second) Mrs. Bessie F. Flemming, a sister of his first wife. She is a native of Pennsylvania.



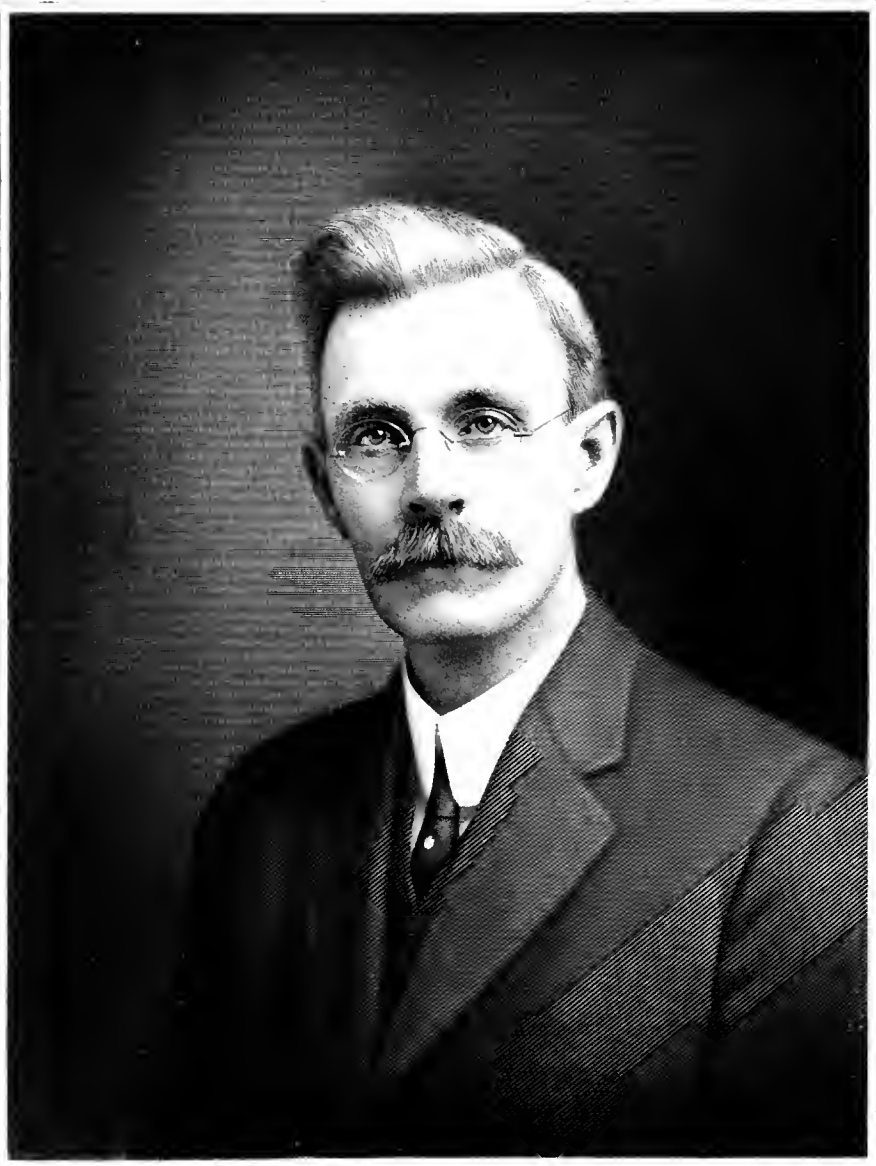

*F. J. Erickson*

## FORREST FRANK HENDRICKSON

There is a certain satisfaction that follows duty well performed, even when results are not as hoped for, but to Mr. Hendrickson has been granted the higher satisfaction of seeing his labors crowned with the best of success. The Eureka Specialty Printing Company, organized with small capital, has grown in importance and influence until it is a firm to be reckoned with, even in important governmental printing, and consultations are not infrequent with high government officials connected with the bureau of engraving and printing at Washington. Forrest F. is a son of John Hendrickson, and a grandson of Uriah Hendrickson, of Great Bend, Susquehanna county, Pennsylvania, and of Dutch ancestry.

John Hendrickson was born in Great Bend, September 11, 1825, died in 1899. He learned the shoemaker's trade in early life, but later engaged in farming, owning his own abundant acres. He followed agriculture for several years, finally selling his farm and returning to the shoe business. He married Mary Ann Curtis and had issue: William, Fred J., Forrest F., Grace.

Forrest F. Hendrickson was born in Jackson, Susquehanna county, Pennsylvania, January 21, 1870. He attended the public schools, finishing at Gibson Graded School, winning by his excellent scholarship the coveted honor of valedictorian of the graduating class. After completing his studies he taught for two years and in 1891 located in Scranton. He began business life as a bookkeeper for the Elk Hill Coal Company, remaining with that concern for three years. He then became salesman for the Eureka Cash Register and Credit Company, introducing their system of cash and credit accounting. He was with the Eureka four years, then was in the retail grocery business with his brother, Fred, for two years. At the end of his mercantile experience he sold out to his brother and returned to the employ of the "Eureka." That company had become sadly in the toils, but Mr. Hendrickson effected a reorganization under the present style and title, The Eureka Specialty Printing Company, with himself as president. The combined cash capital of the owners was but \$5,000, and with this the company started business anew, but confining themselves to specialty printing. The working force in 1903, at the start, consisted of five boys, but under the guidance of Mr. Hendrickson work of quality and attractive design was turned out from the presses and orders flowed in. From this small start, advance has been constant, the end of the first decade in business, 1913, finding one hundred and twenty people on the payroll of the company, and the tiny \$5,000 capital carrying a business of a quarter of a million dollars annually, with goods being shipped to every part of the United States. Pages of laudation could not equal these facts in estimating Mr. Hendrickson's efficiency as an executive manager. He founded, built up, and is the present head of a most prosperous company. In 1909 he with others organized the Green Ridge Bank, with a capital of \$50,000. Of this prosperous financial institution Mr. Hendrickson is president. He is also owner of the Green Ridge Department Store, East Market street, corner of Boulevard avenue, which is under the management of his brother, Fred J. Hendrickson. Probably no man in business in Scranton can show such a record of achievement in a single decade as herein recorded.

Mr. Hendrickson is an active member of the Methodist Episcopal church, and is a trustee of the same. He is a member of the Scranton and Press clubs, the Independent Order of Odd Fellows, and of Camp No. 400, P. O. S. of A. While interested in all that pertains to the public welfare of his city, state and country, he has never entered into political life save in the exercise of his

franchise, his ballot usually being cast for the candidates of the Republican party.

Mr. Hendrickson married, March 10, 1892, Eva May, daughter of John and Anna Price. Children: Blanche, Edna, Mildred, Marion, Evelyn, Forrest, died in 1908, Ollie, Fenton, Robert, Elinor.

---

#### CAREY P. WILLIAMS

The men of deeds are the men who excite the admiration of the world, and when a man rises to a position of prominence, whether it be in the business world or in private life, he merits and receives the esteem and respect of all by reason of the sterling qualities he must undoubtedly possess. It is of such a man that this review treats, in the person of Carey P. Williams, of Scranton, Pennsylvania.

The Williams family of Wales and England is of great antiquity. The surname is derived from the ancient personal name William. Sir Robert Williams, ninth baronet of the House of Williams of Penrhyn, was a lineal descendant from Marchudes of Cyan, Lord of Abergelen, in Denbighshire, of one of the fifteen tribes of North Wales that lived in the time of Roderick the Great, King of the Britons, about A. D., 849. In Wales it was formerly ap Williams, and it is worthy of note that Morgan ap Williams, of Glamorgan-shire, Gentleman, married a sister of Lord Thomas Cromwell, afterwards Earl of Essex, who was the ancestor of the noted Puritan, Oliver Cromwell. The ancient Williams coat-of-arms of the Welsh family is: Sable a lion rampant argent armed and langued gules. The crest is a moor cock. The seat of the family was at Flint, Wales, and in Lincolnshire. The Williams families of America descend from more than a score of different immigrant ancestors, the branch in question here having landed in 1636. The immigrant ancestor's name was Robert.

(I) Erastus Polodore Williams, great-grandfather of Carey P. Williams, and lineal descendant of Robert Williams, was one of the earliest of the pioneer settlers in Vermont, coming there from Massachusetts. He died in Northfield, Vermont.

(II) Silas Williams, son of Erastus Polodore Williams, was born in Randolph, Vermont. He was a farmer there, and died there at an advanced age. He married Cornelia Safford, who died in Randolph, Vermont, at the age of eighty years, and of their four children those now living are: Carlos D., of further mention; Persis Ann, married Frank A. Preston.

(III) Carlos D. Williams, son of Silas and Cornelia (Safford) Williams, was born in Randolph, Vermont, and there grew to manhood. His education was acquired partly in his native town and partly in Northfield, where he learned the drug trade, with which he has been successfully identified all the business years of his life. From Northfield he came to Burlington, Vermont, where he established himself in the drug business and has one of the finest and oldest stores in the city. He has won a reputation for the reliability with which his business is transacted, a matter of paramount importance in a concern of this nature. He was in active service throughout the duration of the Civil war, being first lieutenant in Company F, Twelfth Regiment Vermont Volunteer Infantry. His last position during this struggle was in the commissary department. He is a member of the local post, Grand Army of the Republic, has served for some time as commander, and is holding this office at the present time. He also served on the staff of the state department commander, and has taken an active part and interest in all Grand Army matters. He is also a member of the Loyal Legion and of the Masonic fraternity.



Mr. Williams married (second) Ellen Thayer, born in Northfield, Vermont, and their only child is Carey P., of further mention. Mrs. Williams is a daughter of James C. B. Thayer, a prominent resident of Northfield, Vermont, where he was connected officially with several banks. She has a sister, Alice, who married W. M. Rennbough, and resides in Dales, Oregon, and a brother, H. B. Thayer, vice-president of a corporation in New York City. In our New England Colonial history the family name Thayer has been known since the first half of the seventeenth century, and is closely connected with John and Priscilla (Mullins) Alden, of "Mayflower" fame. The name came to us from England, from the village of Thaydon, in Essex, about eighteen miles north of London. Augustine Thayer, of Thaydon, through the grace of his sovereign, was granted a coat-of-arms, and received other marks of the royal favor. Evidently he was a person of considerable distinction and exercised an influence in the shire in which he lived. Both in the mother country and in New England this surname is found written Thear, Their and Theyer, as well as Thayer, the latter being the generally accepted form of spelling by virtually all of the families on this side of the Atlantic Ocean. The immigrant Thayers were Richard and Thomas, the former of whom had lands granted him in 1635, and was made freeman the same year, and the latter in 1640. They are believed to have come to America as early as 1630, from Braintree, Essex, England, and were among the earliest settlers of Braintree, Massachusetts, in New England.

(IV) Carey P. Williams, son of Carlos D. and Ellen (Thayer) Williams, was born in Northfield, Vermont, May 11, 1880. He received his preparatory education in the public schools and the high schools of Burlington, Vermont, after which he matriculated at the University of Vermont, and was graduated from that institution in the class of 1902. His first business position was with the Baldwin Locomotive Works, at Philadelphia, where he remained one year; he then devoted himself to the telephone business in Philadelphia, then remained one year at Jenkintown; three years at Norristown; one and a half years at Scranton; one and a half years at Reading, Pennsylvania; then returned to Scranton, in October, 1911, and his business interests have since been identified with that city. He was made traffic supervisor of the Scranton-Wilkes-Barre District, comprising a section one hundred and fifty-eight miles wide and two hundred miles long, and he has developed this up to the highest possible standard. He has executive ability of a high order, and this combined with his foresight make of him "the right man in the right place." Mr. Williams has taken an active part in the public affairs of Scranton, was one of the organizers of the Boy Scout Council, and has held official position in this body since 1909. He is a member of the Delta Psi fraternity; the Loyal Legion of the United States, a military organization; the Rotary Club of Scranton Scouts; master of the Boy Scouts; and organized the Reading Council. His religious affiliation is with the Protestant Episcopal church. Mr. Williams married, in October, 1908, Edith C. Lynch, of Philadelphia, and they have children: Carey P. Jr., Charlotte T., John Alden.

---

#### FRED ELIAS BEERS

From Pennsylvania via New Jersey, Connecticut and England, the Beers genealogy may be traced to Holland, in Europe. The settlement in America was made in Connecticut at an early day, from thence two brothers settled in Morris county, New Jersey, from whence came Elias Tompkins Beers, grandfather of Fred Elias Beers, of Scranton, locating in Honesdale, Pennsylvania, the birth-place of the two succeeding generations of this branch.

Elias Tompkins Beers, who came from Morris county, New Jersey, to Honesdale, Pennsylvania, in 1835, was a son of David Beers, and grandson of Nathan Beers, one of the two brothers above referred to. He was a mason, contractor and builder and for many years conducted a large business in and around Honesdale. Monuments to his mechanical skill, sterling integrity and uncompromising honesty, there exist in number, including the Methodist, Baptist, Presbyterian and Lutheran churches, the public building and finest private residences of his day. He married Harriet Pruden, and left issue: Ulysses F., of whom further; Fannie, died in 1911; Delia, married S. A. Roper and yet resides in Dandy, New York.

Ulysses F. Beers, only son of Elias Tompkins Beers, was born in Honesdale, Pennsylvania, October 15, 1842, where he resided until 1913 when he came to reside with his son in Scranton. He spent his active years as a builder, having been a contractor of all forms of mason work, a trade he learned in all its branches and followed until his retirement. He married Amelia S., daughter of Z. M. Pike Bunnell, of Pennsylvania. Children, all deceased except Fred E.: Kniven Kirk, Harriet A., Roscoe D., Carlton F., Fred Elias.

Fred Elias Beers was born in Honesdale, Pennsylvania, November 20, 1870. He was educated in the public schools of Honesdale, finishing at high school, Wyoming Business College (1888-89) then spent two years at Susquehanna Collegiate Institute at Towanda, Pennsylvania. At that point in his career he decided upon the law as his profession, entered the law department of the University of Pennsylvania, whence he was graduated LL. B., class of 1896, returning the following year and taking a post-graduate course. He registered as a law student with Patterson & Wilcox, of Scranton, and in 1896 was admitted to the Lackawanna county bar. After his post-graduate course he opened a law office in the Connell Building, and was there until 1913 when he moved to the Pauli Building. He is a well established, highly regarded attorney of the city, practicing in all state and federal courts of the district, in association with R. Louis Grambs, a graduate of the law department of Cornell University, forming the firm of Beers & Grambs at No. 419 Connell Building. Mr. Beers is a member of the State and County Bar associations, the Knights of Malta, the Patriotic Order Sons of America and Green Ridge Club, and in political action is strictly independent. For five generations in direct line the family heads have been elders and deacons of the Presbyterian church and pillars of strength in their respective congregations.

Mr. Beers married, in 1899, Mazie P., daughter of John and Jemima (Matthews) Davis. Children: Fred Sturges, born November 9, 1900; John Robert, November 20, 1901. The family residence is at Dalton, Pennsylvania.

---

#### SCRANTON PUBLIC LIBRARY

It was indeed a fortunate coincidence for the city of Scranton that in 1889, when a special committee of the Board of Trade presented a report to the effect "that they considered the starting of a free public library in Scranton as feasible, provided the sum of at least \$35,000 could be raised by subscription, and that the chance of being able to do so was sufficiently good to warrant the effort," that John Joseph Albright, now of Buffalo, New York, came to the front and offered to donate the site and building as a memorial to his parents, Joseph J. and Elizabeth Albright. Mr. Albright determined that the building should be centrally located on the Albright homestead site, at the intersection of Washington avenue and Vine street; his brother and sisters joining him in the gift of land, and the entire tender was submitted to the city with the

following conditional clauses: I. For the establishment of a free public library for the use and benefit of the citizens and residents of Scranton. II. That the building be called the Albright Memorial Building. III. That the library therein placed be reasonably maintained. IV. That the same be managed and controlled by a board of sixteen trustees, to be selected and appointed in manner as specified. V. That the management and control provided for may be changed at any time to conform to any general laws of the commonwealth regulating free public libraries, when accepted by a majority of the trustees.

In due time city councils made formal acceptance of Mr. Albright's gift, by an ordinance passed and approved April 5, 1890, in accordance with a deed of gift which conveyed the property to trustees named for the purpose. Building operations were not begun for twelve months, the time being occupied by the preparation of plans, letting of contracts, and for study of the entire situation.

Stimulated by Mr. Albright's magnificent gift, the "Citizens Subscription Fund" soon reached \$25,000; contributions of one hundred and forty-one persons, in sums ranging from \$3.00 to \$1,000, and one of \$5,000. The success of this movement, designed for the purchase of books, was due largely to the constant and untiring solicitations of the Rev. S. C. Logan, D. D., and the equally earnest labors of Henry Belin Jr., treasurer of the committee. The first stock of books purchased numbered about fourteen thousand six hundred volumes, all of which were minutely catalogued and placed in condition for use; so that, on the completion of the building, and its dedication, the latter occurring on May 25, 1893, the library was ready to be opened to the public, whose use of the same began on the first of June, following. As soon as the proposed library became a certainty, negotiations were begun by the library board for a librarian, their choice falling upon Henry J. Carr, a most fortunate selection, who was engaged to undertake the organization of the library; a work he accomplished with painstaking fidelity and has since continued as librarian.

By a subsequent will of Trustee William Tallman Smith \$1,000 was bequeathed the library, which has been invested to found the "William Tallman Smith Mining Section Fund," the income from the bequest to be used for the purchase of technical works on mines and mining. The library depends solely upon city appropriations for its support, which it has received annually, since its founding, in sums varying from \$10,000 to \$15,000 and upwards. By judicious application of those somewhat limited appropriations the library has been able to fill a long felt need in the life of the city; and, as an educational centre, has served well the purpose of its founder and is an enduring memorial to the parents of John Joseph Albright. The success of the library, too, has been due to the stability of the board of trustees, several of the original members still serving.

The Albright Memorial Building was erected at a final cost to its donor of \$125,000, and is a substantial structure of pleasing architecture, in French chateau style of the fifteenth and sixteenth centuries; the exterior material being gray Indiana limestone, based on brown Medina stone, all laid in coursed ashlar. The main portion of the building runs parallel with Vine street, and is two stories in height, with a basement, from which a right angle wing projects, slightly lower, containing three stack room floors and a large room above. The roofs are high, of steep pitch, with twelve dormer gables, covered with black Spanish tiles. In the panels of the dormers, as on other parts of the building, are elaborately carved symbols of the notable early bookmakers. Iron window sash, English casement style, have the glass leaded in various patterns, and the transoms contain leaded medallions, showing the distinguishing

marks and devices used by the early printers; while large colored glass windows, in prominent portions of the building, depict celebrated book-bindings of past centuries. The entrance hallway is laid in marble mosaic and the interior finish is in quartered oak, including the first story ceiling. Plate glass partitions divide the lower floor into rooms, a view of the entire length being possible. Three fireplaces constructed of imported marbles give a striking effect. Including the stack-rooms, main building and basement, there is shelving space possible for seventy thousand volumes. In the near future an addition will be necessary; a prediction based upon the past growth and the already crowded conditions now existing.

Henry James Carr, librarian of the Scranton Public Library, son of Colonel James Webster and Jane D. (Goodhue) Carr, was born in Pembroke, New Hampshire, August 16, 1849. He obtained his education in the grammar and high schools of Manchester, New Hampshire, and Grand Rapids, Michigan. From 1867 to 1886 he was accountant and cashier in commercial and railway offices, later taking a partial law course at the University of Michigan and gaining admission to the bar in 1879, although never engaging in the practice of the profession. In 1886 he became librarian of the Grand Rapids Public Library, continuing as such until 1890, when he went to Saint Joseph, Missouri, to organize a free public library in that city. In the following year he came to Scranton, Pennsylvania, where he assisted the board of managers in their plans for the new institution, his experience being a great help to those in authority. Since that time he has been the capable head of the active library work, the city receiving from his competent management a library of exceptional system. He is a member of the American Library Association and from 1886 to 1893 was its treasurer; from 1895 to 1896 recorder; vice-president in 1896; secretary from 1898 to 1900; president from 1900 to 1901; and a member of its council to the present time. In other organizations relative to his calling he has also been prominent and is past vice-president and past president of the Pennsylvania Library Club; and past president of the Keystone State Library Association. He is a contributor to several technical periodicals, his articles being mainly on commercial accounting and library topics. In his chosen calling, Mr. Carr has achieved an enviable reputation, his prominence among others of the same following proving his worth, inasmuch as the judgment of one's colleagues is the final test of merit. Mr. Carr married, May 13, 1886, D. Edith Wellbridge, of Springfield, Illinois.

---

#### CHARLES DUDLEY SANDERSON

In the person of Charles Dudley Sanderson the Scranton district is possessed of a citizen, who besides holding a prominent position in many circles, is backed by the prestige of ancestry through "Mayflower" descent through his father's mother, Mary (Cook) Sanderson, a member of this family having had passage on that famous vessel.

(I) The pioneer ancestor of the Sanderson family settled in Waltham, Massachusetts, in 1636, marrying, October 15, 1645, Mary Eggleston, of Dorchester, and had children: Deacon Jonathan, of whom further; Hester.

(II) Deacon Jonathan Sanderson, of Cambridge, was born September 15, 1646, probably moved to Piety Corner, Waltham, about 1689, died September 3, 1735, and is buried in the old graveyard at Waltham. He married, October 24, 1669, Abbie Bartlett, born May 28, 1651, died September 13, 1723, and was buried by the side of her husband. They were the parents of: John; Samuel, of whom further; Edward, died in 1776, married Mary Parkhurst and had



AT THIS POINT,  
ON THE OLD DOWNSD ROAD AS IT THEN WAS,  
ENDED THE MIDNIGHT RIDE OF  
PAUL REVERE.

HE HAD, AT ABOUT TWO O'CLOCK OF THE MORNING  
OF APRIL 19, 1775, THE NIGHT BEING CLEAR AND THE  
MOON IN ITS THIRD QUARTER, GOT THIS FAR ON HIS  
WAY FROM LEXINGTON TO CONCORD, ALARMING THE  
INHABITANTS AS HE WENT. WHEN HE AND HIS  
COMPANIONS, WILLIAM DAWES, OF BOSTON, AND DR.  
SAMUEL PREGGOTT, OF CONCORD, WERE SUDDENLY  
HALTED BY A BRITISH PATROL WHO HAD STATIONED  
THEMSELVES AT THIS BEND OF THE ROAD. DAWES,  
TURNING BACK, MADE HIS ESCAPE. PREGGOTT,  
CLEARING THE STONE WALL, AND FOLLOWING A PATH  
KNOWN TO HIM THROUGH THE LOW GROUND, REAINED  
THE HIGHWAY AT A POINT FURTHER ON, AND GAVE THE  
ALARM AT CONCORD. REVERE TRIED TO REACH THE  
NEIGHBORING VILLAGE, BUT WAS INTERCEPTED BY  
A PARTY OF OFFICERS ACCOMPANYING THE PATROL,  
DETAINED AND KEPT IN ARREST. PRESENTLY  
HE WAS CARRIED BY THE PATROL BACK  
TO LEXINGTON, THERE RELEASED, AND THAT  
MORNING JOINED HANCOCK AND ADAMS.

THREE MEN OF LEXINGTON, SANDERSON,  
ERMAN AND LORING, STOPPED AT AN EARLIER  
BEND OF THE NIGHT BY THE SAME PATROL,  
WERE ALSO TAKEN BACK WITH REVERE.

*Tablet on the road to Concord*

*(in the town of Lincoln.)*

*Marking the end of Paul Revere's Ride*

two children; Hannah, married George Stearns, of Lexington, and settled at Waltham.

(III) Samuel Sanderson, son of Deacon Jonathan and Abbie (Bartlett) Sanderson, was born May 28, 1681, and was killed by lightning, July 8, 1722. He married, April 13, 1708, Mercy Gale, born September 16, 1683, died May 8, 1776. Children: Samuel, served in the French and Indian war; Abraham, married Patience Smith, settled in Lunenburg and they were the parents of thirteen children; Jonathan, of whom further; Mercy; Moses, married (first) Mary Flagg, (second) Elizabeth Goddard.

(IV) Jonathan (2) Sanderson, son of Samuel and Mercy (Gale) Sanderson, was born February 24, 1714, died March 31, 1780. He married (first) Mary Stearns, (second) Mary Bemis, born March 10, 1722, died August 16, 1801, their marriage having been solemnized February 26, 1744. He was the father of: Mary; Esther, married Captain Phineas Stearns, being his second wife; Samuel, of whom further; Sarah; Elijah David; Nathan, married (first) Elizabeth Bond, (second) Mrs. Mary Hastings, and had ten children, all by his first marriage; Jacob Jonathan, married Mary Adams; Anna, married Isaac Pierce.

(V) Samuel (2) Sanderson, son of Jonathan (2) and Mary (Bemis) Sanderson, was born September 8, 1748, moved to Lancaster about 1776, and died in 1800. He was a soldier in the Revolutionary war. He was captured on the same evening and at the same place as Paul Revere, as is told in the following lines:

#### TABLET ON THE ROAD TO CONCORD.

(In the Town of Lincoln)

#### AT THIS POINT

On the old Concord road, as it then was, ended the midnight ride of Paul Revere. He had at about two o'clock of the evening of April 19, 1775, the night being clear and the moon in its third quarter, got thus far on his way from Lexington to Concord, alarming the inhabitants as he went, when he and his companions, William Dawes, of Boston, and Dr. Samuel Prescott, of Concord, were suddenly halted by a British patrol, who had stationed themselves at this bend of the road. Dawes, turning back, made his escape. Prescott, clearing the stone wall and following a path known to him through the low ground, regained the highway at a point further on, and gave the alarm at Concord. Revere tried to reach the neighboring wood, but was intercepted by a party of officers accompanying the patrol, detained and kept in arrest. Presently he was carried by the patrol back to Lexington, and there released, and that morning joined Hancock and Adams. Three men of Lexington, Sanderson, Brown, and Loring, stopped at an earlier hour of the night by the same patrol, were also taken back with Revere.

Mr. Sanderson married at Lexington, Massachusetts, October 27, 1772, Mary Monroe, who died in Lexington, October 15, 1852, at the marvelous age of one hundred and four years. In the Hand Book of Lexington Massachusetts, published in 1891, under the direction of the Lexington Historical Society, Mary Monroe Sanderson is mentioned as follows: "Near the old Monroe Tavern, a little below and on the same side of the road, is the old Sanderson House in which a wounded soldier was left by the British under the care of Mrs. Sanderson. She lived to the remarkable age of one hundred years and used to tell that the English soldier feared that she meant to poison him and would not take food or drink until some member of the family had tasted it. In this house was born Lewis Downing, the famous coach builder." Samuel and Mary (Monroe) Sanderson had issue: Amos; Mary, married Daniel Clark; Samuel, of whom further; Nancy; Lydia, married Ezra Fiske, of Weston, Massachusetts; Isaac, of East Cambridge.

(VI) Samuel (3) Sanderson, son of Samuel (2) and Mary (Monroe) Sanderson, was born January 17, 1776, died July 18, 1829. He married Eunice, daughter of George L. Lawrence, born May 3, 1784, and had children: Benjamin Lawrence, of whom further; Marshall; Chester, married Sarah Stickney; Caroline, married Edward Goodnow; Grace; Elizabeth Herrick; Harriet.

(VII) Benjamin Lawrence Sanderson, son of Samuel (3) and Eunice (Lawrence) Sanderson, was born in West Cambridge, Massachusetts, and was a lieutenant-colonel in the Massachusetts Militia, his commission from Levi Lincoln, governor of the state, reading as follows:

His Excellency, Levi Lincoln, Governor and Commander in Chief of the Commonwealth of Massachusetts to Benjamin L. Sanderson, Esq. Greetings—

You have been elected on the 10th day of July, 1832, Lieut. Colonel of the First Regiment of Cavalry in the First Brigade and Third Division of the Militia of the Commonwealth; reposing special trust and confidence in your ability, courage, and good conduct, I do, by these presents, Commission you accordingly. You will therefore with honor and fidelity discharge the duties of said office according to the laws of this Commonwealth and to the Military Rule and Discipline. And all inferior Officers and soldiers are hereby commanded to obey you in your said capacity, and you will yourself observe and follow such Orders and Instructions as you shall from time to time receive from the Commander in Chief, or others your Superior officers.

Given under my hand and the seal of the Commonwealth the 14th day of July, 1832, and in the 57th year of the Independence of the United States of America.

By His Excellency, the Governor,

Signed,

LEVI LINCOLN.

EDWARD BANGS, Secretary of the Commonwealth.

Benjamin L. Sanderson married Mary C. Cook and had children: Theodore Lyman, born in 1824, married (first) Mary ———, (second) Lizzie Corey; Emily, married William Kidder; Clarence Marcellus, of whom further.

(VIII) Clarence Marcellus Sanderson, son of Benjamin L. and Mary C. (Cook) Sanderson, was born at Charlestown Neck, now Arlington, Massachusetts, June 9, 1829, and until he was thirteen years of age attended the common school of West Cambridge, at that age moving to Vermont. Upon attaining his majority he engaged in business in the copper mining regions of Lake Superior, in 1865 becoming a member of the firm of Day, Huddle & Company, coal dealers, in Malden, Massachusetts, and in 1876 became the owner of the Phoenix Colliery at Pittston, Pennsylvania, organizing the Pan-coast Coal Company, of Scranton, the property of that company being in Throop. This concern enjoyed a successful continuance and Mr. Sanderson was connected therewith the remainder of his active life. He maintained his residence in Newark, New Jersey, his summer home being in the beautiful village of Madison, New Jersey. He was well known in social and fraternal organizations, belonging to the Essex Club of Newark, Lodge, Chapter, Commandery and Shrine of the Masonic Order, the Benevolent and Protective Order of Elks, the Royal Arcanum and the Knights of Honor. He married (first) in 1851, Mary Orinda, who died in 1864, daughter of the Hon. John Waite, of West Randolph, Vermont; (second) in 1866, Mrs. Eliza A. Bellman, of Harrisburg, Pennsylvania. Children of first marriage: Mary Emma, born in 1853; Charles Dudley, of whom further. By his second marriage he had one son, James Murray, born in 1872, a graduate of Columbia Law School, class of 1895.

(IX) Charles Dudley Sanderson, son of Clarence Marcellus and Mary Orinda (Waite) Sanderson, was born at Rockland, Ontonagon county, Michigan, October 13, 1856. His birthplace was a log cabin, and in 1862 he accompanied his parents to Malden, Massachusetts, and to Newark, New Jer-







*C. M. Anderson*



*Chas. D. Anderson*



sey, in 1866. He obtained his education in the public and private institutions of Malden, Massachusetts, and Newark, New Jersey, in December, 1874, moving to Waverly, New York, three years later to Wilkes-Barre, Pennsylvania. In April, 1879, he returned to Waverly, learning the trade of machinist in the locomotive works of the Lehigh Valley Railroad Company, at Wilkes-Barre, and at Waverly. Moving to Throop, Pennsylvania, on January 26, 1882, he entered the employ of the Pancoast Coal Company, subsequently serving that corporation in a variety of capacities, among them locomotive engineer, weighmaster, bookkeeper and paymaster, being made general superintendent of the company on October 1, 1888. For fourteen years and two months he directed the multifarious and complicated affairs of this concern, resigning his position at the end of that time, the ownership of the company having changed hands. Mr. Sanderson took up his residence in the city of Scranton, April 1, 1901, entering into business as a stock broker, his services, because of his well known business record, being greatly in demand. He was later appointed treasurer of a manufacturing concern, and was afterward engaged as manufacturer's agent in the sale of machinery and supplies, a business offering practically inexhaustible resources in such a community as Scranton. While a resident of Throop, Mr. Sanderson took an active part in all public affairs and gave abundantly of his time and efficient service to his city, the same characteristics having marked his career as a member of the Scranton community. He was appointed postmaster of Throop by President Arthur, January 5, 1882, holding this office continuously for nineteen years, and on February 17, 1885, was elected Burgess of Dickson City borough, serving one year. He was a member of the school board of Dickson City borough, being elected in February, 1887, serving as secretary for three years, at the end of that time being re-elected and was made president of the board. When the setting off of Throop from the borough of Dickson City was proposed he was prominent in the agitation of this matter and instrumental in securing incorporation papers for the new borough, which were granted April 16, 1894. On May 1, 1894, he was elected school director of the borough of Throop, holding the office of secretary for one year, being re-elected the following year, and for three years was president, secretary and treasurer, respectively. For seven years he was treasurer of Throop Hose Company, No. 1, of which he was a founder, a fire-fighting organization which has performed meritorious service in the borough. Since April 1, 1898, Mr. Sanderson has been a vestryman of St. Luke's Episcopal Church, having been re-elected each year since that date. He is a Thirty-second Degree Mason, belonging to Peter Williamson Lodge, No. 323, F. and A. M., of which he is past master; Lackawanna Chapter, No. 185, R. A. M.; Scranton Council, No. 44, R. and S. M.; Keystone Consistory, Sovereign Princes of the Royal Secret; Coeur de Lion Commandery, No. 17, K. T., of which he is a past eminent commander; and Lulu Temple, Ancient Arabic Order Nobles of the Mystic Shrine. He is also a member of Scranton Council, No. 923, R. A.; I. O. of H., Providence Council, No. 195; Scranton Board of Trade; and the Scranton Engineers' Club. Mr. Sanderson is numbered among the members of the New England Society, of Northeastern Pennsylvania, of which he is vice-president, and the Pennsylvania Society, Sons of the Revolution.

Mr. Sanderson married, September 10, 1887, Gertrude, daughter of Andrew Jackson and Jemima Ellen (Sax) Griffith, of West Pittston, Pennsylvania, and has children: Charles Dudley Jr., born at Throop, Pennsylvania, the birth-place of his brother and sister, October 14, 1889; Lucy Griffith, born May 15, 1893; Clarence Marcellus, born November 4, 1894.

## RUFUS J. FOSTER

Rufus James Foster, son of Clement Storer and Rebecca (McCamant) Foster, and cousin of Thomas Jefferson Foster, founder of the International Correspondence Schools, was born in Minersville, Schuylkill county, Pennsylvania, October 10, 1856. He was educated in the public and private schools of Ashland, Pennsylvania, and when eighteen years of age secured a position in the mining engineering department of the Philadelphia and Reading Coal and Iron Company, a connection which continued greatly to his benefit, because of the vast fund of practical experience he was accumulating, until the fall of 1887, when upon resigning his position he associated himself with his cousin, Thomas Jefferson Foster, in the publication of the *Colliery Engineer*, a technical mining paper then published at Shenandoah, Pennsylvania, now its seat of publication being Scranton, whither it was moved in 1888. With Mr. Foster as editor, a circulation campaign was inaugurated, the highest authorities on mining subjects were obtained as contributors, and the general tone of the journal so raised that as a conservative and reliable organ of mining information it was unsurpassed, in consequence of which it is now the most widely read of all periodicals in its special field. Upon the incorporation of the company in 1890, Mr. Foster became a member of the board of directors and at the organization of that body was elected president.

In 1890 he assisted Thomas J. Foster in the formation and organization of the first department of the International Correspondence Schools, and since that year has been continuously connected with the International Textbook Company, of which he is now vice-president and was formerly president. This company is one of the largest publishers of technical works, and prepares the textbooks used by the International Correspondence Schools. Mr. Foster's personal ability and energetic enthusiasm has contributed largely to the success which has attended the company since its incorporation and many new features are the result of his careful planning.

Mr. Foster is a member of the Board of Trade, of the Engineers' Club of Scranton and the American Institute of Mining Engineers; is an associate member of the American Society of Mechanical Engineers, and is an honorary member of the Coal Mining Institute of America. In the Masonic Order he is a member of Peter Williamson Lodge, No. 323, F. and A. M.; Lackawanna Chapter, No. 185, R. A. M.; Scranton Council, Royal and Select Masters; Coeur de Lion Commandery, No. 17, K. T.; and Irem Temple, Ancient Arabic Order Nobles of the Mystic Shrine. He also belongs to the Scranton Club, the Scranton Country Club, the New England Society of Northeastern Pennsylvania, of which he was president in 1910-11, and the Pennsylvania Society, Sons of the Revolution. Politically he is a supporter of the Republican party, and holds religious affiliation with St. Luke's Protestant Episcopal Church, of which he is a vestryman.

Mr. Foster married, September 9, 1884, Jane Bennett Taylor, born January 9, 1858, youngest daughter of Joseph F. and Adeline (Nice) Taylor, of Minersville. Joseph F. Taylor was a member of the Society of Friends, and a pioneer coal operator of the Schuylkill region. Mr. and Mrs. Foster have one son, Joseph T., a graduate of Yale University, A. B., class of 1908, a representative of the brokerage firm of Montgomery, Clothier & Tyler, of Philadelphia.

## JAMES W. GUERNSEY

For a half of a century a business man of the city of Scranton, James W. Guernsey entered business life only after failing health had compelled the abandonment of a plan of activity that he had cherished through young manhood, the practice of law. He is a native of Pennsylvania, descendant of a New England family that was settled in Pennsylvania by James W. Guernsey's grandfather, Joseph U. Guernsey, coming from Connecticut.

(I) Joseph U. Guernsey made his home in Susquehanna county, Pennsylvania, in 1802, and there became a man of position and prominence. He married and they had children: John W., for many years a member of the Pennsylvania state legislature; Peter B.; Warren; Levi B., of whom further; Hiram C.; Anna; Sophia, married Peter William and had a son, Henry W., for many years a judge of the superior court of Pennsylvania, passing a great part of that time as president judge.

(II) Levi B. Guernsey, son of Joseph U. Guernsey, was born in Canaan, Connecticut, in 1798. He married Hannah P. Carrier and they had children: George M., married Martha Roche and they had children, Maud and Fannie; Peter C., married Martha Allen and they had children; James W., of whom further; J. Frank; Ophelia C., died young; Abbie M., married George M. Sweet, a soldier of the Union army, who met his death at the battle of Gettysburg; Sophia W., married William Clark; Almira C., married Alonzo M. Stearns; Marie M., married J. K. Brady, of Scranton; Alice, married Frank Lamberson.

(III) James W. Guernsey, son of Levi B. and Hannah P. (Carrier) Guernsey, was born at Bridgewater, Susquehanna county, Pennsylvania, December 31, 1846. He there attended the public schools until he was eighteen years of age. After graduating from Montrose Academy, he was for one year a school teacher, then went to Michigan and for three years taught in the State Reform School at Lansing. At the end of this time he began the study of law under the direction of Professor Angell, one of the most brilliant lawyers and most able jurists of his day, but ill health made it necessary to relinquish his legal ambitions. After discontinuing his studies for the profession of law Mr. Guernsey moved to Scranton, there establishing himself in the sale of musical instruments, a line he had since followed. His stock includes instruments of all kinds, wind and string, all of a high and reliable grade, and through his long continuance in this business he has come to own a steady patronage, held to his store because of the uniformly courteous and attentive treatment there received and because there value is given in every transaction. He has prospered in gratifying measure, his business being not only the oldest of its kind in the city, but one which compares more than favorably with others of a similar nature. Mr. Guernsey is a member of the Masonic Order, with which he became identified in Lansing, Michigan, and belongs to the Second Presbyterian Church of Scranton. His political stand is independent.

Mr. Guernsey married Mary C. Ives, a teacher of the Scranton public schools, and they are the parents of the following children: Jessie, married N. B. Spencer, of Honesdale, Pennsylvania, and is the mother of James and Ruth; May, married A. C. Curtis; Edwin; Bertha, married John Roderick, and they are the parents of Lois and Mary; Clara, unmarried, acting book-keeper and active in the business with her father.

## REV. WILLIAM P. O'DONNELL

Father O'Donnell has been for a quarter of a century a priest of the Roman Catholic church in the Scranton district, in that time identified with two churches. His administration has been in every way a success, and the expansion that has taken place under his leadership has been of far-reaching influence, its outward evidence, the erection of a new and costly house of worship, being one of its least important effects.

Rev. William P. O'Donnell is a son of Patrick and Ann (McNelis) O'Donnell. His father was a native of Ireland, and here he passed his entire life, a butcher and dealer in cattle. William P. O'Donnell was born in Donegal, Ireland, October 10, 1855, and there obtained his early education, his native land being his home for the first thirteen years of his life. Coming to the United States at that age he attended the public schools of Wilkes-Barre, and later taught in Sugar Notch, afterward entering Kingston Academy, whence he was graduated in the class of 1878. He then became a student in St. Charles College, receiving a diploma of graduation from this institution in 1880, and then took up the study of theology in the Roman Catholic Seminary, at Baltimore, Maryland. After completing his course he was ordained into the ministry of the Roman Catholic church at Scranton, July 25, 1889, the Right Rev. Bishop O'Hara officiating at the ceremony. On November 19, following his ordination, he was appointed assistant to the Rev. Father McManus, pastor of the Providence church, and was there in service until May 1, 1897, when he was appointed to the pastorate of the Holy Cross Church, of Scranton, by the Right Rev. Bishop O'Hara, the dignitary who performed the rites that made him a priest of the Church.

Since this date Rev. Father O'Donnell has been in charge of the Holy Cross congregation, first building for their use a temporary church at the corner of Fifth avenue and Broadway, the structure being dedicated on July 4, 1897. The congregation has now in the course of erection a church edifice that, when completed, will have cost seventy-five thousand dollars and will be a worthy temple for a congregation of the strength of that of the Holy Cross Church. Rev. Father O'Donnell has here perfected a church organization efficient and useful, his leadership able and inspired. He is a member of the Holy Name Society and the Catholic Mutual Benefit Society. His political convictions are according to the teachings of no political organization.

---

DAVID J. REEDY

David J. Reedy was born in Scranton, Pennsylvania, August 8, 1871, son of John and Hannah (O'Malley) Reedy, who passed the greater part of their lives in the city of Scranton, where John Reedy was engaged in the grocery business, in which he was highly successful. They were the parents of five children: Walter M., a practicing physician of Scranton; David J., of this review; Mary E., John J., William A.

David J. Reedy attended the public schools of his native city, then pursued a course of study in the parochial schools, after which he matriculated in St. Michael's College, Toronto, Canada, and subsequently became a student in the law department of the University of Pennsylvania. He was admitted to the bar, October 1, 1892, and he established in general practice in Scranton, for a time serving as solicitor of the local school board, and on September 1, 1907, receiving an appointment as first assistant district attorney. Becoming thoroughly familiar with the duties and requirements of the office by his incumbency of that position, upon his appointment as district attorney, January



2, 1912, he entered vigorously upon his administration, serving with usefulness until January 5, 1914, when his term expired. During that period and all through his professional career his conduct has been marked by a strict sense of honor, from which neither desire nor temptation has induced him to swerve. The Democratic party is that which has ever claimed his allegiance, and he is a communicant of the Roman Catholic church. Among the organizations in which he holds membership are the Benevolent and Protective Order of Elks, the Modern Woodmen of America, the Improved Order of Red Men and the Scranton Country Club.

Mr. Reedy married, October 23, 1901, Agnes Crossen, deceased, and has one daughter, Margaret.

---

### GEORGE WASHINGTON SLOCUM

The first Slocum of record in the Lackawanna and Wyoming Valleys of Pennsylvania is Joseph Slocum, the great-great-great-grandfather of George Washington Slocum, of Scranton, Pennsylvania. Joseph Slocum was a great-great-grandson of Anthony Slocum, the founder of the family in America, a family of honorable record from early colonial times. While the name is found under varied spellings, the form "Slocum" has been quite uniformly adhered to since 1700, by the descendents of Giles Slocum, eldest son of Anthony, who is the common ancestor of all Slocums in America claiming colonial ancestry dating prior to the year 1700. Anthony Slocum was of English birth, Somersetshire believed to have been the family seat, and 1637 the year of the arrival in New England. The coat-of-arms of "Slocombe" of Somersetshire is thus described. "Argent on a fess gules between three griffins' heads couped sable, as many sinister wings or." Crest: "Griffin's head gules between two wings extended or."

(I) Anthony Slocum, the emigrant, is recorded as one of the forty-six "first and ancient purchasers" in 1637 of the territory of Cohannet, which was incorporated as Taunton in New Plymouth, now Massachusetts, March 3, 1639. In 1662 he moved to that part of New Plymouth, which in 1664 was incorporated as Dartmouth township. He is believed to have become a member of the Society of Friends, which was the cause of his removal to Dartmouth and his exclusion from the rights of citizenship. His wife is believed to have been a sister of William Harvey, who was also one of the "first purchasers" of Taunton.

(II) Giles Slocum, eldest son of Anthony Slocum, was born in 1618 in Somersetshire, England, died in Portsmouth township, Rhode Island, 1682. He was a land owner, prosperous and energetic, and a member of the Society of Friends. His wife, Joan (Barton) Slocum, "the wife of old Giles Slocum she Dyed at Portsmouth the 31<sup>st</sup> 6 mo 1679," according to Friends' record of Portsmouth, was the mother of nine sons and daughters.

(III) Samuel Slocum, the seventh child of Giles and Joan (Barton) Slocum, was born November 4, 1657. He resided in or near Newport, Rhode Island, where he married and had a son Giles (2).

(IV) Giles (2) Slocum, son of Samuel Slocum, was born in Newport, Rhode Island, 1680, was there admitted a freeman in May, 1707, and died prior to 1724. He married, at Newport, November 27, 1707, Mary, daughter of Ralph and Dorothy Paine, of Freetown.

(V) Hon. Joseph Slocum, eldest son of Giles (2) and Mary (Paine) Slocum, was born in Newport, Rhode Island, was married there to Patience Carr, September 27, 1724, and moved to East Greenwich township, Rhode Island. He was admitted a freeman there in 1732 and became a farmer and

land dealer. He was deputy to the general assembly of Rhode Island, 1741-1742 and 1744. There is little known of his later life, but in Miner's "History of the Wyoming Valley" (Pennsylvania) he is named as one of the first settlers of Kingston, about 1768. His first wife, Patience, was a daughter of Caleb Carr, of Jamestown. He married (second) in 1743, Hannah \_\_\_\_\_, who bore him a daughter. By his first wife he had six children, all daughters, except the fourth child, Jonathan.

(VI) Jonathan Slocum, son of Hon. Joseph and Patience (Carr) Slocum, was born in East Greenwich township, Kent county, Rhode Island, May 1, 1733, was killed by the Indians on the town plot of Wilkes-Barre, Pennsylvania, December 6, 1778. He married, February 23, 1757, Ruth Tripp, born March 21, 1736, died at Wilkes-Barre, Pennsylvania, May 6, 1807, daughter of Isaac Tripp, of Warwick. After his marriage they lived in Warwick, where he purchased land of his father-in-law and followed his trade of blacksmith. His father, Joseph Slocum, and Isaac Tripp, his father-in-law, went to the Wyoming Valley of Pennsylvania about 1768. Jonathan Slocum, leaving his family behind, followed them and bought land now within or very near the present city of Scranton. Afterward he returned to Rhode Island, coming again to the Wyoming Valley in the year 1774, settling with his family in a house within one hundred yards of Wilkes-Barre Fort. On November 2, 1778, a party of Delaware Indians invaded the settlement and carried away his five year old daughter, Frances. In 1835 she was found living in Miami county, Indiana, widow of an Indian Chief, possessed of considerable property and a person of influence among the Indians. She died March 9, 1847. On December 16, 1778, Jonathan Slocum and his father-in-law, Isaac Tripp, were killed by the Indians and Tories, and William Slocum, son of Jonathan Slocum, wounded, although he escaped. Jonathan Slocum was a member of the Society of Friends and kindly disposed toward the Indians, from whom he considered himself free from attack, being a non-combatant. His eldest son, Giles, was one of the few who escaped massacre after the battle of Wyoming; Judith, his eldest daughter, married Hugh Forsman, who fought in the same battle and was one of the fifteen of Captain Hewett's company that escaped slaughter and the only one to bring off his gun; William, the second son, was wounded as stated, later became sheriff of Luzerne county, and one of the prominent and influential members of his company; Ebenezer, of further mention; Mary, the second daughter, married Joseph Towne; Frances, "the Indian Captive," was called by the Indians Ma-con-a-qual, meaning "young bear," she married (first) an Indian "Little Turtle," (second) the chief of the Miamis named She-poe-kew-ah, but called by the whites "The Deaf Man;" she was later in life reunited with her family, but never returned to them; she had forgotten her own tongue; she was well cared for and lived in comfort with her Indian friends until her death; a portrait of Frances Slocum appears in Lossing's "Field Book of the Revolution" and in Peck's "History of Wyoming," engraved from an oil painting, painted for her brother, Joseph, in 1839; Benjamin, the fourth son, was the first postmaster in the Lackawanna Valley and in 1826 occupied his farm, now the site of the present village of Tunkhannock, Pennsylvania; Isaac, Joseph and Jonathan, the eighth, ninth and tenth children, all married and reared families.

(VII) Ebenezer Slocum, third son and fourth child of Jonathan and Ruth (Tripp) Slocum, was born in Warwick township, Kent county, Rhode Island, January 10, 1766. He came to Pennsylvania when eight years of age, and died from apoplexy on the street while on a visit to Wilkes-Barre, Pennsylvania, July 25, 1832. He was one of the earliest settlers of Providence, (now Scranton) and in 1798 purchased an interest in a grist mill at Deep Hollow,

which he named Umonville, carrying that name on his books until 1828, when he adopted the local name for the place "Slocum Hollow." He there built a distillery in 1798 and a saw mill in 1799. In the latter year his brother Benjamin purchased the interest of James Duwain. The brothers in 1800 built an iron forge and in 1811 another distillery. The isolated settlement became an important trading point and so continued until the iron ore was exhausted in 1822 and the partnership between the brothers dissolved. Ebenezer Slocum built the first frame house at the "Hollow" in 1805 and it was a landmark known as the "Old Slocum red house," the oldest house in Scranton. The first lodge of Odd Fellows in Scranton was organized in this house and for a time meetings were held in a room over the kitchen. In 1875 the old house was torn down to give further room for the extensive street works. In 1821 Ebenezer Slocum was justice of the peace, the district then including the present Pittston, Providence and Exeter townships. He was a good thrifty man of business and acquired 1800 acres now included within the limits of Scranton and all underlaid with coal. He gave the first period of business prosperity to Scranton (as it is now) and when the brothers ceased operations progress was checked in the "Hollow" for several years.

Ebenezer Slocum married, in Warwick, Rhode Island, December 3, 1790, Sarah Davis, born August 31, 1771, died November 1, 1842, daughter of Dr. Joseph and Obedience (Sperry) Davis. They were the parents of thirteen children, nine of them sons. All of these married except Charles Miner and Mary.

(VIII) Joseph (2) Slocum, fifth child and fourth son of Ebenezer and Sarah (Davis) Slocum, was born at the home of his grandfather, Dr. Davis, in Wilkes-Barre, Pennsylvania, July 15, 1800, died in Scranton, June 22, 1890. During his minority he was employed in the different lines of activity with his father and became an expert worker in metal, being able to forge anything from a horse shoe to the complicated parts of machines. He also made all the boots and shoes for the family, was a good horseshoer and for a time ran the saw mill. He worked on the Delaware and Hudson Canal for a few months and for eighteen months for Rodolphus Bingham. He then, in association with his brother, Samuel, managed his father's estate and was so employed until the latter's death in 1832. The estate of 1800 acres was divided by the administrator into four parcels, Joseph and Samuel obtaining lot No. 4, containing 505 acres. He bought from his brothers and sisters until he owned 626 acres, located in the heart of Scranton, and on account of the coal underneath it of great value. He was a man of remarkable endurance, and was the victim of more serious accidents than is believable, yet lived to a good old age although crippled by the many broken ribs and bones he carried. The sale of his lands realized him a handsome fortune, and no man was more highly respected in the city than "Uncle" Joseph Slocum. He never used tobacco or ardent spirits. He was a Whig and Republican, was the first burgess of Scranton borough, and held many local offices. He was one of the first poor directors and while he was in office no taxes were levied on the poor.

Mr. Slocum married, December 22, 1830, Edilda Bingham, daughter of Rodolphus and Sally (Kimball) Bingham, of Palmyra, Pike county, Pennsylvania, becoming acquainted with her while working for her father. For two years after marriage they each lived with their parents, beginning house-keeping in a new frame house near the old stone still house. Later they moved to the "Old red Slocum house." She was born December 24, 1805, and on December 22, 1880, the aged couple celebrated their golden wedding. Children: Joseph Warren, of whom further; Rodolphus Bingham, born May 4, 1845, married, in May, 1874, Anna Lloyd, and moved to Jonesville, Wisconsin.

(IX) Joseph Warren Slocum, eldest son of Joseph (2) and Edilda (Bingham) Slocum, was born July 23, 1833, in Scranton, died August 31, 1913. He was one of the seven children who comprised the first school in Slocum Hollow. He was a lumber dealer in Scranton, and for twenty years was deputy United States marshal. He married, in Salem, Wayne county, Pennsylvania, February 21, 1856, Hannah M. Collins. Children: Florence Weston, born April 3, 1858; Frank Huntington, born June 20, 1861, married Carrie Faust; Kate, born July 22, 1865, married F. A. Taylor, income assessor in Rock county, Wisconsin, and they have three children, Helen, Philip and Allen, and reside in Janesville, Wisconsin; Joseph, born November 22, 1867, married Eunice Kimble; Ida, born May 7, 1870, died in infancy; Bessie, born October 16, 1871, died October 8, 1877; George W.

(X) George W. Slocum, youngest child of Joseph Warren and Hannah M. (Collins) Slocum, was born in Scranton, May 25, 1876. He was in business in Janesville, Wisconsin, in the sale of coal and wood, farming implements, etc. He returned to Scranton, in 1904, and was associated with his father up to the time of his death. He married, August 14, 1902, Clara, daughter of Herman Kellogg. Children: Jay Warren, born July 1, 1905; George K., November 16, 1907; Louis C., August 12, 1913.

#### LOUIS WATRES HEALY

The business activities of Louis Watres Healy, of Scranton, Pennsylvania, have at this time assumed a more general turn than earlier in his career, when his profession, that of electrical engineer, claimed all of his time and attention. The Westinghouse Electrical and Manufacturing Company and the Pennsylvania Railroad Company were the companies with which his early experience as an electrical engineer was obtained, while the greatest work he accomplished along electrical lines was as president and general manager of the United Power Company, of East Liverpool, Ohio. Business interests in Scranton know him now as secretary of the Wayne Development Company, secretary of the Scranton Cold Storage Company, as president of the Shoshone Tungsten Mining Company, of Nevada, vice-president of the Spring Brook Water Supply Company, while he is associated in an advisory capacity with a number of the city's institutions.

Mr. Healy is a son of Samuel Healy, the latter born in 1836. Samuel Healy was educated for the profession of a civil engineer, and followed that calling for several years. He became a soldier in the Fifty-sixth Regiment Pennsylvania Volunteers, when war was declared between the states, and served through that struggle as adjutant with the rank of captain. He was engaged in many of the most important conflicts of the war, and was wounded at the battle of Gettysburg, receiving an honorable discharge from duty at the close of the war. The strain and exposure of life at the front had so lowered his vitality and strength that his death occurred a short time after the cessation of hostilities. He married Florence Eugenia, daughter of Louis S. Watres, and they had one son, Louis Watres, of whom further.

Louis Watres Healy, son of Samuel and Florence Eugenia (Watres) Healy, was born in Dunmore, Pennsylvania, December 4, 1866. His preliminary education was obtained in the public institutions of Scranton and under private instruction, and in 1886 he entered Cornell University, receiving his degree of electrical engineer from that institution in 1890. He first entered the service of the Wightman Electric Company, of Scranton, one year later going with the Westinghouse Electric and Manufacturing Company, of Pittsburgh, with which corporation he remained for three years. While still as-

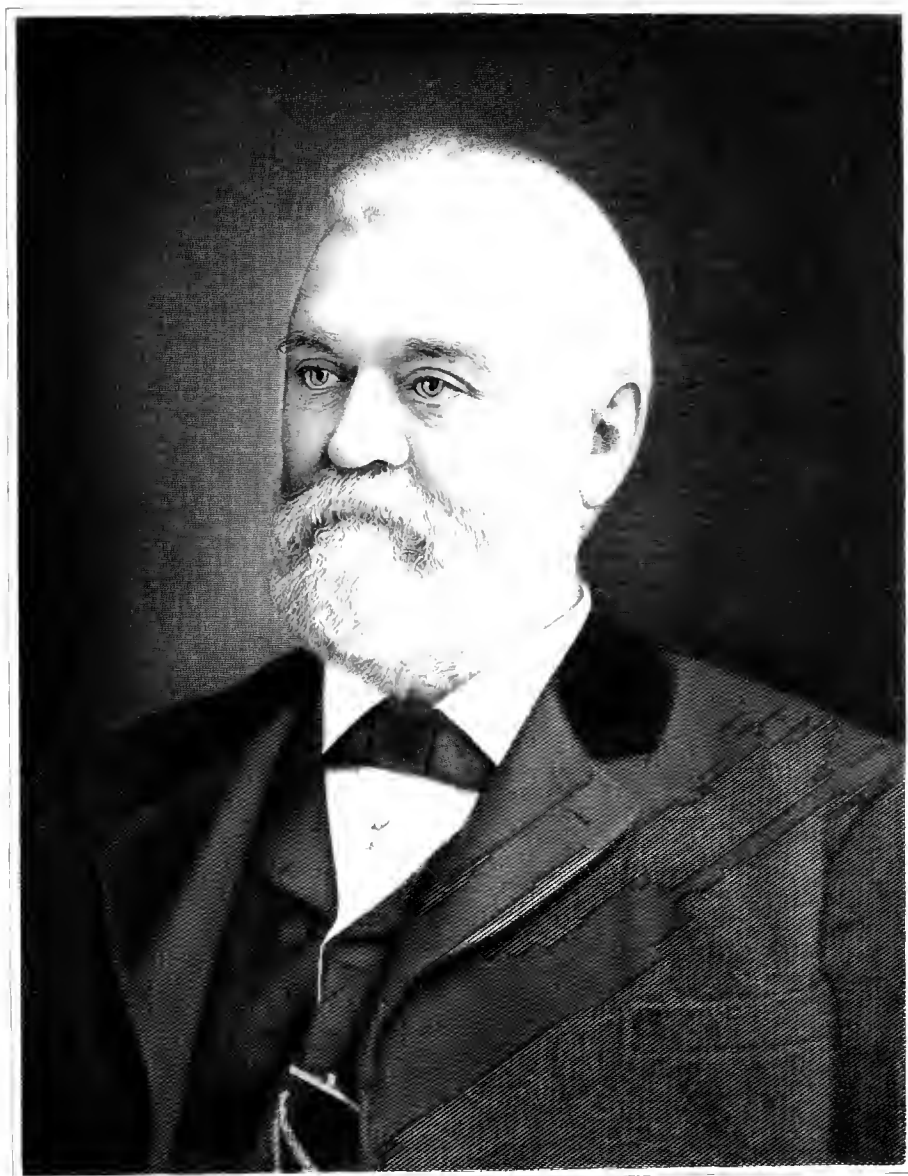

*J. W. Hoover*



sociated with the Westinghouse Company, Mr. Healy received an appointment to the electrical department of the Pennsylvania Railroad, being located at Altoona, Pennsylvania, the latter corporation his employer for a period of three years.

With his appointment to the presidency of the East Liverpool Railroad Company, Mr. Healy transferred the scene of his activities from Pennsylvania to Ohio. Not long afterward he became president and general manager of the Ceramic City Electric Light Company, and then president and general manager of the Wellsville Electric Light Company, three important concerns controlling public utilities, there being associated with Mr. Healy in these companies Colonel Watres and William F. Hallstead. Through the activity of Mr. Healy, these three companies were consolidated under the title of the United Power Company, of which he was president and general manager until the Liverpool properties were disposed of. While holding these high positions in the United Power Company, Mr. Healy was likewise president and general manager of the Island Run Coal Company, having acquired valuable coal lands to which the railroad extended its line for operation. His administration of his various offices was in every way a success, and in the merging of the individual companies into one controlling interest he put into practice organizing powers and abilities that made his work perfect and complete.

Mr. Healy's return to Scranton was for the purpose of undertaking the utilization of the Paupack river water power for the generation of electricity to supply the Lackawanna and Wyoming valleys and since that time he has remained in the city. He is now secretary of the Wayne Development Company, holding the same office in the Scranton Cold Storage Company, and is vice-president of the Spring Brook Water Supply Company. He is, as previously stated, president of the Shoshone Tungsten Mining Company, owning properties in Nevada. He is a member of the Phi Kappa Psi and the Theta Nu Epsilon fraternities, to which he was elected while a student at Cornell University.

Mr. Healy married, in 1896, Louise Bright Rowe, of Atlanta, Georgia, and they are the parents of Joel Watres, born May 20, 1900; Louis Hollister, born March 16, 1904.

---

#### FRANK RAYMOND STOCKER

Paternal grandfather, Albert Stocker, came to Salem township, Wayne county, Pennsylvania, in 1840 from Fairfield county, Connecticut, where the family had lived since the middle of the seventeenth century, having emigrated from England. Paternal grandmother, Lydia Rebecca (Peet) Stocker, whose earliest American ancestor, John Peet, came from Duffield Parish, Derbyshire, England, to New England, on the ship "Hopewell" in 1635 and became one of the pioneer settlers of Stratford, Connecticut. Maternal grandfather, Albert R. Raymond, was a Presbyterian minister, educated at Union College, and at Princeton Theological Seminary. He preached for upwards of forty years in the villages of Hamlington and Sterling, Wayne county. The Raymond family were French Huguenots and emigrated to England at the time of the persecution of Nantes and from England emigrated to the Genesee Valley, New York State. Maternal grandmother, Mary (Wright) Raymond, a member of the Wright family of Massachusetts.

(II) James D. Stocker, son of Albert and Lydia Rebecca (Peet) Stocker, was born in Salem township, Wayne county, Pennsylvania, March 9, 1850. He received a good education and spent his early life in Wayne county, going to Jermyn, Pennsylvania, in 1872, where he engaged in the mercantile busi-

ness, at first for himself and later in partnership with S. W. Cook, until 1898. He is interested in various enterprises, among others the Wilson Lumber & Milling Company, the Huntingdon Water Supply Company, the Armstrong Water Company, the National Water Works & Guarantee Company, the Consumers Water Company of Montrose, in all of which institutions he is an officer.

(III) Frank Raymond Stocker, son of James D. and Frances (Raymond) Stocker, was born in Jermyn, Pennsylvania, July 24, 1876. He attended the public schools in Jermyn, and prepared for college in the School of the Lackawanna at Scranton, graduating from the latter institution in the class of 1894. He then entered Yale University, whence he was graduated with the degree of Bachelor of Arts in the class of 1898. At college, he stood eleventh in his class and took special honors in Economics and History. At graduation, on account of the illness of his father, he assisted in his business for a year and a half, and then entered upon the study of law in the offices of Willard, Warren & Knapp, and on January 29, 1901, was admitted to the bar of Lackawanna county and later to the Supreme Court of Pennsylvania, as well as the Federal courts of the districts, in which he practices. For several years he had charge of the legal and claim departments of the Pennsylvania Casualty Company, a position he resigned in the spring of 1909. Since April 1, 1909, he has engaged in the general practice of law, with offices at 603-04 Mears building, Scranton, Pennsylvania. In 1912 and 1913 he was assistant district attorney of Lackawanna county. He is a member of the First Presbyterian Church of Carbondale, Pennsylvania. In politics, he is a Democrat and served one term as chairman of the Lackawanna County Democratic Committee.

On October 17, 1901, he married Marion Fraser Crane, daughter of Israel and Mary (Lathrope) Crane, of Carbondale, Pennsylvania. Mrs. Stocker died March 18, 1914. Children: James D., born September 10, 1902; Dwight L., born February 8, 1904; Frank R. Jr., born January 3, 1909. Mr. Stocker lived in Jermyn until the death of his wife, since which time he has been living at 92 Lincoln avenue, Carbondale, Pennsylvania.

#### GEORGE F. HOWER

Hower & Stender, lumber dealers, hold high position, not only among firms operating in their line, but among the flourishing, substantial and reliable institutions of the city of Scranton. The business of the firm is a large one, giving employment to one hundred and fifty men. George F. Hower, one of the members thereof, is a descendant of a German family, Germany having been the birthplace of his ancestors. The grandfather of George F. Hower died as the result of injuries sustained in an accident in a stone quarry, where he was employed, and he was survived by two children, Mary, Jacob J., of whom further. His wife died aged eighty-two years.

Jacob J. Hower was born in Germany in 1834, died in 1888. In the year that he attained man's estate he came to the United States, after learning the trade of blacksmith, and entered the employ of the Delaware, Lackawanna & Western Railroad. Several years afterward Mr. Hower resigned from this service, and in partnership with his brother-in-law established a grocery store at Hyde Park, trading as Warnke & Hower. This firm continued for a period of thirteen years, at the expiration of which time Mr. Hower sold his interest and became barn boss at Briggs shaft for the Lackawanna Coal Company, and while discharging the duties of that office met with an accident that caused his death, the second of his line to have his life shortened by casualty. He



married Elizabeth Fern, and had children: 1. Mary, deceased. 2. George F., of whom further. 3. Martha, married A. F. Rickert, of Scranton; children; Elizabeth, Anna, May, Mabel, George. 4. August, engaged in business in Scranton; married Bessie Wagstaff. 5. Annie, married Jacob Ollendick; children: Edna and Ruth. 6. Emma, married John J. F. York, of Scranton; children: Albert and Darwin. 7. Mary, married Joseph M. Thompkins. 8. John Jacob, employed by his brother, George F.; married Bessie Powell; children: Helen, Mildred, John.

George F. Hower, son of Jacob J. and Elizabeth (Fern) Hower, was born in Scranton, Pennsylvania, November 26, 1865, and until he was thirteen years of age was a student in the public schools. At that age he began picking slate in the breaker, later becoming a driver, and was then for one year employed with the Lackawanna Bakery Company, leaving this company to learn the trade of carpenter, which he followed for eighteen years. For a time his employer was John D. Kohl, and he served in the capacities of carpenter, foreman and superintendent, afterward forming a partnership with his former employer, an association which the death of Mr. Kohl, which took place nine months later, brought to an abrupt termination. On March 15, 1897, Mr. Hower entered into partnership with Herman F. Stender, the present firm of Hower & Stender the result of that combination, its prosperous condition the result of the progressive ideas and unremitting toil of the two men who have well and successfully conducted their business for seventeen years. Hower & Stender do not confine their operations to lumber dealing, contracting and building being lines in which they have been active and in which they have met their competitors with as favorable issue as in lumber dealing. The business of the firm in the past year totalled three hundred thousand dollars, a sum attained through steady increase annually, and which it is but reasonable to believe will remain the high water mark of the concern for but a short time. In the transaction of the firm's business the services of one hundred and fifty employees are required, and on the seventeenth anniversary of the founding of Hower & Stender this force presented their employers with a large and beautiful flag, mounted on a staff, in honor of the occasion and as an expression of their good will and esteem. Mr. Hower's business activities are to a large extent confined to the management of the firm's affairs, although he finds time to serve as a director of the Central Loan and Investment Company. He is a thirty-second degree Mason, his lodge the Green Ridge, Free and Accepted Masons, while he is a charter member of the local lodge of the Knights of Malta, and for the past thirty years has belonged to Camp No. 178, P. O. S. of A. His church is the Lutheran, and in politics he recognizes the dictates of no party, acting independently in local and national affairs.

Mr. Hower married, December 28, 1892, Anna W., daughter of Frank Earley, a veteran of the Civil War. Mr. and Mrs. Hower are the parents of: Floyd Earley, born August 18, 1896; George F. Jr., born November 22, 1899; Martha Elizabeth, born October 28, 1909.

---

#### JAMES HUMPHREY TORREY

James Humphrey Torrey, a prominent attorney of Scranton, Pennsylvania, is descended from an English family whose first representative in this country was William Torrey, of Combe, St. Nicholas, England, who settled in Weymouth, Massachusetts, about 1640. His descendant in the tenth generation was Major Jason Torrey, who settled in northeastern Pennsylvania in 1794, and was one of the organizers and promoters of Wayne county. He

built the first house ever erected in Honesdale, Pennsylvania, and among his eleven children were: Hon. John Torrey, of Honesdale; Rev. Stephen Torrey, of Honesdale; Mrs. Colonel Richard L. Seeley, of Honesdale, mother of Hon. H. M. Seeley; Mrs. Elijah Weston, mother of E. W. Weston, Esq., of Scranton; and Rev. David Torrey, D. D., the youngest, who was graduated from Amherst College and the Union Theological Seminary, and was ordained a minister in the Presbyterian church. He was pastor in Delhi, Ithaca and Cazenovia, New York, and in Ann Arbor, Michigan. He married Mary E., a daughter of Rev. Heman Humphrey, D. D., LL. D., and Sophia (Porter) Humphrey; a grand-niece of Dr. Noah Porter, of Farmington, Connecticut; and a cousin of Dr. Noah Porter, president of Yale University. The first American ancestor of the Humphrey family was Michael Humphrey, who came from England to Windsor, Connecticut, in 1643. Rev. and Mrs. Torrey had children: Sarah M. and James Humphrey.

James Humphrey Torrey was born at Delhi, Delaware county, New York, June 16, 1851. After preparation in the lower public schools, he became a pupil in the high schools of Ann Arbor, Michigan, and of Northampton, Massachusetts, and then became a member of the class of 1873 of Amherst College. He left during his junior year, but has since received the degree of Master of Arts from that institution. On January 10, 1872, Mr. Torrey commenced the study of law in the offices of Willard & Royce, of Scranton, Pennsylvania, and at the end of six months formed a connection with the Delaware & Hudson Canal Company, first as a member of the engineer corps, then as weighmaster at the mines, the latter position enabling him to find sufficient leisure time to pursue his legal studies, which he did to such good effect, completing them in the office of E. B. Sturges, in Scranton, that he was admitted to the bar of Luzerne county, November 20, 1876. From the time of his admission to the bar Mr. Torrey has devoted himself to the practice of his profession, with a very satisfactory amount of success. The Scranton Board of Trade appointed him as its representative in the inter-municipal conventions of 1886-87, and he was one of three engaged in drafting and securing the passage of the act of May 24, 1887, for the government of the smaller cities of the state. From the time of its organization, Mr. Torrey was the treasurer of the Lackawanna Bar Association, for a number of years secretary of the Lackawanna Law Library Association, and has served as chairman of the board of examiners of law students. He was for many years a manager, and for two terms the president of the Young Men's Christian Association of Scranton. Church affairs have also engaged a considerable share of his attention, and he served as superintendent of the Sunday school of the Second Presbyterian Church, and was appointed an elder in the church in 1886.

Mr. Torrey married, December 10, 1872, Ella C., a daughter of Douglas H. Jay, of Scranton, whose great-great-uncle was John Jay, the first chief justice of the United States, and whose grandfather, Joseph Jay, of New Brunswick, New Jersey, distinguished himself as an officer during the Revolution, and later destroyed his vouchers for payment for the services he had rendered. Mr. and Mrs. Torrey have children: Mary Humphrey, married to A. E. Fitch; William Jessup; Elizabeth Jay, married to W. B. Kirkpatrick; Douglas Jay.

---

#### PROFESSOR FRANK J. DANIEL, F. A. G. O.

Possessor of a musical training received in the conservatories of Scotland, England and the Continent, Professor Frank J. Daniel, F. A. G. O., has



*Frank J. Daniel*



since 1906 been a most welcome addition to musical circles in the city of Scranton, a city noted for the excellence of its talent along that line and for the strength and ability of its organizations for the promotion and fostering of musical taste in Scranton. Professor Daniel is organist and musical director of St. Peter's Cathedral, of Scranton, a position he has held for the past eight years, and in that time has gained high praise for the musical services of the Cathedral, which he has placed upon a high plane.

Professor Frank J. Daniel was born in Carlisle, England, June 3, 1874, and began his musical career as a choir boy in a church at Oban, county of Argyle, Scotland, where he remained for seven years, during that time placing himself under the instruction of Dr. Clemens, a noted performer and teacher. He remained abroad until 1900, studying ceaselessly all of that time, and in that year came to the United States, for five years residing in Williamsport, Pennsylvania, where he was organist at Trinity Church, teaching music as well. In 1906 he became organist and musical director at St. Peter's Cathedral, and since his arrival in Scranton has specialized in vocal, organ and piano concert work, many of his efforts coming before the public through his connection with the Catholic Hall Club. Not only have the recitals given under his directions been unusually fine productions, calling the notice of the city to the extraordinary talent within their midst, but through his connections abroad he has been directly responsible for the American visits of some of Europe's favorite artists. Professor Daniel is a Fellow of the American Guild of Organists, a degree which is a coveted honor, about sixty belonging, election thereto being based upon excellence as a performer and theoretical attainments of a very high order. With Professor Daniel his art is an all-absorbing passion, and he finds no pleasure equal to encouraging the development of talent in a brilliant pupil, in whose musical conquests he takes as great delight as though they were his own, as indeed they are. The works of the old masters are known to him with a familiarity almost amazing, and to hear him perform upon the organ is to have a revelation of the power and beauty of that sympathetic instrument. In the rise of Scranton to further prominence among the American cities known as art centers, Professor Daniel will have a leading part, for in such effort no labor is too great, no detail too minute, to receive his faithful attention.

Professor Daniel married, in 1903, Charlotte Mitchell, born in Syracuse, New York, and is the father of: Cuthbert Francis, Maude, William, Gabriel

---

#### WILLIAM McCLAVE

The life of William McClave, a representative citizen of Scranton, has been an active one, and his enterprises are such as have added to the general wealth and welfare of his adopted city. Scrupulously honorable in all his dealings with mankind, he bears a reputation for public and private integrity, and being sociable and genial, he has a host of friends, composed of all classes of society.

William McClave was born in Scotland, February 7, 1844, but was reared and educated in the United States, being brought to this country by his parents when he was two years of age, they settling in Boonton, New Jersey, where they resided until 1850, a period of four years, and then took up their residence in Scranton, Pennsylvania, William McClave receiving a practical education in the public schools of that city. He then became an employee of W. G. Doud & Company, at Hyde Park, serving an apprenticeship at the trade of tinsmith, in which line of work he became highly proficient, later working for several years as journeyman, and subsequently established a business on

his own account in Pittston, carrying a full line of stoves and hardware, and in the conduct of this enterprise he achieved a large degree of success, it being the foundation for his future success. Being of an inventive turn of mind, and possessing genius of a high order, he invented a stove-grate, known as the Dockash grate, which was placed in the stoves manufactured by the Scranton Stove Works, and which proved of such practical value as to at once attract the favorable attention of dealers. As a result, Mr. McClave disposed of his store, and entered the employ of the Scranton Stove Works, traveling in their interest for three years, during which time he succeeded in creating a large demand for their product.

At the expiration of his three years' travel, Mr. McClave sold his patent to Colonel J. A. Price, of the Scranton Stove Works, and he directed his attention to the invention of means for more effectually consuming the waste products of the anthracite coal fields, culm and buckwheat as they were known. Various attempts had already been made in this direction, but with only partial success. Nothing daunted by the failures of his predecessors, and possessing a strength and force of character which would overcome obstacles which to others less hopeful and less courageous would seem unsurmountable, he persisted in his experiments, and finally perfected the excellent device known as the McClave Grate and Argand Steam Blower, which has proved of great value and which has been used extensively. He then entered into business relations with Reese G. Brooks, and for a number of years they had the grates and blowers manufactured in the machine shop of L. A. Finch & Company. As their business increased rapidly in volume and importance, it was found imperative to increase their facilities, and with this end in view they organized the firm of McClave, Brooks & Company, which rented the old foundry of the Scranton Stove Works, in West Lackawanna avenue. Subsequently the firm purchased a site on Seventh street, near the bridge of the Delaware, Lackawanna & Western Railroad, with a six-story building upon it, and a commodious foundry and suitable office buildings were erected, affording ample accommodations for that time. In 1902 the business was incorporated as the McClave-Brooks Company, and a site was purchased comprising about thirteen acres on Diamond Flats. Upon this was at once commenced the erection of an immense modern plant, covering nearly eight acres of the area, increasing the capacity of the work five-fold. With the increased facilities they added to the scope of their work, beginning the manufacture of mechanical stokers, and other devices in the same line, and giving employment to four hundred men when running to full capacity. The McClave appliances have from that time to the present been in general use, and well-nigh without a rival. They are adapted to every description of fuel, and can be placed under boilers and in furnaces of nearly every description. Their trade extends throughout the length and breadth of the United States, maintaining branch offices in nearly all the principal cities. Mr. McClave invented his first article, the Dockash grate, in the autumn of 1877, and since then the patents issued in his name from the United States and foreign offices number upwards of eighty, all covering devices of approved practicability and worth.

Mr. McClave, although a Scotchman by birth, is a true American, and his loyalty and patriotism was proven by his answering President Lincoln's first call for troops at the commencement of the Civil War, becoming a member of Company K, Fifteenth Regiment Pennsylvania Volunteers. In 1862 he re-enlisted, becoming a member of Company K, Fifty-second Regiment Pennsylvania Volunteers, being chosen to the grade of first (orderly) sergeant. He served efficiently under General McClellan in the peninsular campaign, but the excessive duties and continual exposures incident to those operations, in a

region of swamp, and during the rainy season of the year, so impaired his health as to bring upon him a severe attack of typhoid fever, and he was honorably discharged from the government service upon a surgeon's certificate of disability. He suffered for some time from the effects of his strenuous service, but finally recovered his health and was able to resume his daily avocations.

Mr. McClave is a member of the Penn Avenue Baptist Church, serving in the capacity of trustee, and also taking an active interest in all the work connected therewith. He is a Republican in politics, but has never sought or held public office, his time being entirely devoted to his business pursuits. He is an active member of the Board of Trade of Scranton; of the Engineers' Club; of Lieutenant Ezra S. Griffith Post, No. 139, G. A. R.; of the Fifty-second Regiment Association of Pennsylvania Volunteers, of which he is president; and of Peter Williamson Lodge, No. 325, F. and A. M.

Mr. McClave married, April 11, 1864, Mary Rowland, a native of Wales, and they are the parents of one son, William R., who was formerly connected with the Scranton Steel Works in the capacity of assistant paymaster, and is now associated with his father in business, being manager and treasurer of McClave-Brooks Company; he married Margaret Brooks, daughter of Reese G. Brooks and his wife, Mary H. (Morgan) Brooks, and they are the parents of three children: Robert Brooks, Mary Brooks, Arthur Brooks.

---

#### CLARENCE S. WOODRUFF

In the two generations of Woodruffs with which this narrative deals the pursuit of the pedagogical profession played a prominent part, although both abandoned it after a time, one in favor of the mercantile business, the other to study law. Lewis H. Woodruff was son of Andrew Woodruff, born at Litchfield, Connecticut, in 1758. Lewis H. Woodruff was also born in Litchfield, Connecticut, February 25, 1798. This was his home until he was seven years of age, when his parents moved to Triangle, New York, in which place he received the major part of his early education. He later entered Hamilton College and in 1824 was awarded an A. B. by that institution. For the next five years he engaged in teaching, first at Binghamton, New York, for three years, and then at Montrose, Susquehanna county, Pennsylvania, for two years. Subsequently he moved to Le Raysville, Bradford county, Pennsylvania, and there became the proprietor of a general store, also teaching for a time a private school. He married Almeda, daughter of William Hutchinson. Children: Maria, married Dr. T. J. Wheaton; Alice; Lewis H., a graduate of Madison University; Caroline M.; Fannie M.; William H.; Sarah A.; Isadore N.; Clarence Samuel, of whom further; Clara S.

Clarence Samuel Woodruff was born in Dimock, Susquehanna county, Pennsylvania, March 6, 1855. He attended the public schools and later graduated from the high school at Binghamton, New York. He then entered Yale and graduated in the class of 1878, a classmate of Ex-President Taft. He then obtained a position as instructor in the Mansfield (Pennsylvania) Normal School, continuing for two years, read law in Montrose, Pennsylvania, and later became principal of the Montrose (Pennsylvania) High School, continuing in that capacity for three years. In the fall of 1884 he began the practice of his profession at Scranton, where he has since resided. In political belief, Mr. Woodruff is a strict Prohibitionist, observing with conscientious regard the principles of his party. He is a member of the Presbyterian church. His fraternal relations are with the Independent Order of Heptasophs and the Patriotic Order Sons of America.

Mr. Woodruff married (first) August 1, 1881, Susan M., daughter of Asa and Lucretia (Sweet) Bullock; (second) August 27, 1896, Agnes Muskett. Children: Clara L., a graduate of Bryn Mawr College, A. B., class of 1905, married Robert A. Hull; Lelia T., a graduate of Bryn Mawr College, A. B., class of 1907, married F. J. Stokes; Margaret, a graduate of Wells College, A. B., class of 1909; A. Allen, a graduate of Yale University, A. B., class of 1912; Lewis H., a graduate of Yale University, class of 1914, A. B.; Amy, a student at Scranton High School, class of 1915; Ruth, a student at Scranton High School, class of 1915; Alice; Francis and Florence, twins; Dorothy; Clarence S. Jr.; Eleanor; Rollin S., deceased.

---

#### GEORGE LARDNER BRECK

Major George Lardner Breck, born in Wilmington, Delaware, August 23, 1837, son of William and Gabriella Breck, was educated in the schools of the city of his birth. After leaving school he went to New York in the office of Howland & Aspinwall, one of the largest shipping firms of New York; this was in 1857; he went in as junior clerk, advanced to be cashier of the firm and remained there five years. Then he went into the ship brokerage business on his own account, and remained in that business five years, at the end of which time he came to Scranton to engage in the coal mining business at Mocanaqua, Pennsylvania. He remained in this business until the property was sold in 1875, when he retired.

The military career of George Lardner Breck is one of which he may well feel proud. He is a member of the Twenty-second Regiment, National Guard of New York, which he joined in 1861 as a private, and served the full term. In 1862, at the time of the invasion of Lee, the Twenty-second Volunteers were ordered to Harper's Ferry, Virginia, where they remained over three months. Their time expiring about that time, the secretary of war asked them to stay longer, or until reinforcements came to Harper's Ferry. When the relief came, consisting of twelve thousand men, the Twenty-second with one or two other regiments returned to New York. However, again in 1863, the Twenty-second was called out, and in June went first to Harrisburg, Pennsylvania, remained there a few days, and on being ordered to join the Army of the Potomac, met this army at Wainsboro. While they were at Carlisle, Pennsylvania, the Confederates shelled the town and burned the United States barracks. They did not participate in the battle of Gettysburg on account of not reaching that place in time. After this great battle, as their services were no longer needed, the Twenty-second Regiment again returned to New York, at which time Mr. Breck was honorably discharge.

In 1877, at the time of the riots in Scranton, the Battalion of City Guard of four companies were formed under Major Boies. Mr. Breck joined Company D, Captain Ripple's company. Subsequently this battalion with four other companies was formed into the Thirteenth Regiment, National Guard of Pennsylvania; then Mr. Breck was made inspector of rifle practice with the rank of captain. They developed many fine marksmen on the old range on the hill, under the captaincy of Mr. Breck, and they had such promising numbers of crack shots, that it was suggested they go to Creedmoor, New York, to compete with the several teams from the National Guards throughout the country. This was in 1879, but they took away no prizes until 1882, when they won the Army and Navy Journal Cup, a regimental trophy; the Interstate Match, the Soldier of Marathon Statue; and the Hilton trophy, presented by Henry Hilton, of New York, costing \$3,000. This was a great event for Scranton. With much rejoicing the victors were welcomed home



And there was not one who did not realize that in good measure the triumphs were due to Captain Breck's good judgment in the selection of his competitors, his patience in training them, and the encouragement he gave them. In 1885 Captain Breck won the appointment he deserved, as division inspector of rifle practice of the National Guard of Pennsylvania, with the rank of major. And in 1887 he was detailed on the staff of Governor Pattison, during the absence of Colonel Shakespear, who was the general inspector of rifle practice. After Colonel Shakespear returned, Major Breck sent in his resignation.

Major Breck married, September 28, 1882, Mary Hale Breck, daughter of George and Emily McQueen (Hale) Breck, both natives of Philadelphia. Major and Mrs. Breck have no children, but they have an adopted son, George William Breck, a son of Mrs. Breck's brother who died about the time his son was born and whose wife died five years later. The son is now residing in New York City.

Both Major and Mrs. Breck are members of the Episcopal Church of the Good Shepherd. He is also allied with the Ezra Griffith Post, No. 139, G. A. R. Of the members of his rifle team that shot on the Creedmoor range, only five are now living: Charles H. Welles, E. W. Ives, Henry M. Ives, James H. Rittenhouse and Major Breck. Major Breck's home is at No. 1649 Sanderson avenue.

---

RALPH E. WEEKS  
ARTHUR L. WEEKS

In commemorating and perpetuating the lives of those men whose careers have been of signal usefulness and honor to the city of Scranton, it is necessary that mention be made of Ralph E. Weeks, a prominent and active factor in a number of the leading enterprises of that thriving city, and probably the greatest compliment that can be paid to him is that he has made himself an honor to the great commercial world, as well as a credit to the mercantile community in which he lives. Public-spirited to the highest degree, he is ever forward in encouraging enterprises which can in any way advance the interests of Scranton.

(I) Levi Weeks, grandfather of Ralph E. Weeks, was born in Draycott, England, in which country he was reared and educated, emigrating to the New World in 1842, aged eighteen years, settling in Skaneateles, Onondaga county, New York. Later he purchased a farm located one and a half miles outside the village of Skaneateles, on which he resided for many years, and this he cultivated to a high state of perfection, deriving therefrom a goodly income. The last twenty-five years of his life he lived retired in the village of Skaneateles, enjoy a well earned rest, the sequel of a life of activity and toil. He was a staunch Republican in politics, and although he never sought or held public office, he took an active interest in the affairs of the party of his choice. He and his family were members of the Methodist Episcopal church, regular attendants at the services, and took an active part in the work of the various societies connected therewith. He married Eliza Radford, a native of England, who bore him children: Thomas; Levi Jr., married and was the father of Harry, Maud, Mary; William T., of whom further: C. Albert, married Anna Feltus and their children were: Lambert L., Melwin R., G. Rosswell, Forest, Zorada. Mr. Weeks died in 1904, at the age of eighty-two years, and his wife at the age of eighty-one years, and their remains are interred in Skaneateles Cemetery.

(II) William T. Weeks, father of Ralph E. Weeks, was born in Skaneateles, New York, September, 1844, died April 3, 1893, at the early age of

forty-nine years, while still in the prime of life. His boyhood days were spent on the homestead farm, and his education was obtained in the common schools of the neighborhood and Cazenovia Seminary. At the age of eighteen years he removed to the village of Skaneateles and entered the employ of his uncle, Forest G. Weeks, a paper manufacturer of Skaneateles Falls, New York, remaining with him for a short period of time. He then became a member of the firm of Knox & Weeks, shoe merchants, and after severing his connection with that concern again turned his attention to farming, conducting his operations on the old homestead farm of his wife's people, which then belonged to his father-in-law, David Cuddeback, a successful farmer, and there spent the remainder of his days, the farm proving a profitable source of income under his capable management. He cast his vote for the candidates of the Republican party, and was an active member of the Methodist Episcopal church, also interested in the work of the Sunday school connected with it. He married Martha M. Cuddeback, born in Skaneateles, New York, November 9, 1853, daughter of David Cuddeback. She is living at the present time (1914) and is a member of the Elmpark Methodist Episcopal Church of Scranton, also holding membership in the Ladies' Aid Society of the same. Mr. and Mrs. Weeks were the parents of seven children, namely: 1. Ernest H., president of the Weeks Hardware Company, and interested in the R. E. Weeks Company, both of Scranton; married Harriet C. Hineman, of Syracuse, New York. 2. Ralph E., of whom further. 3. Arthur L., of whom further. 4. Fanny J., wife of Winford B. Hornbaker, secretary and general manager of the Blackhorn Sales Company; son, Robert W. 5. Nellie G., wife of Frederick A. Lyford, treasurer of the Weeks Hardware Company; daughter, Mary Elizabeth. 6. Theodore W., secretary of the Weeks Hardware Company; married Doris Short, of Atlantic City, New Jersey. 7. Marguerite E., wife of Roy W. Cobb, secretary and manager of the Ashley Silk Manufacturing Company.

(III) Ralph E. Weeks was born in Skaneateles, New York, February 9, 1878. He was reared on the homestead farm, gaining health and strength in the open life of the country which thoroughly prepared him for the activities of life, and his education was obtained in the district schools and Skaneateles high school, graduating from the latter institution in the class of 1895. In July of the same year he took up his residence in Scranton, Pennsylvania, and accepted the position of assistant bookkeeper for the Foote & Shear Company, located at No. 119 Washington avenue. The valuable service he rendered the company was appreciated, and three years later, in 1898, he was promoted to a more responsible position, that of treasurer, in which capacity he served until 1902, when he was appointed president, a still further honor, and performed the duties of that high office until the firm was succeeded by the Weeks Hardware Company, in 1908, and he acted as president of that concern for the first year, then became the vice-president, which position he has since held, his brother, Ernest H. Weeks, being the president. In addition to this office he is president of the Ralph E. Weeks Company, Weeks Realty Company, Capouse Warehouse Company, Danville Hardware and Supply Company of Danville, a director of the J. D. Williams Stores, treasurer of the Blackhorne Leather Company, and director of the Trader's National Bank. He is equally active and prominent in other lines of activity, serving as president of the Scranton Board of Trade, treasurer of the Young Men's Christian Association, and one of the seven members of the Recreation Bureau of Scranton, institutions of great value to the community.

Mr. Weeks married, November 22, 1904, Elizabeth Porter, born in Scranton, April 6, 1883, eldest daughter of John T. and Harriet S. (Schlager)



*Ralph C. Neels*







*C. Hicks.*

Porter, of Scranton. Mrs. Weeks is a member of the Century Club of Scranton. Children: Clara E., born December 15, 1906; John Porter, born May 24, 1908; Eleanor M., born January 31, 1910. Mr. and Mrs. Weeks are prominent in the social life of the community in which they reside, and have a wide circle of friends and acquaintances.

(III) Arthur L. Weeks was born at Skaneateles, New York, February 10, 1882. He came to Scranton, February 25, 1897, where he was a pupil at Public School No. 35, and also at the Scranton High School, and was well equipped for entrance upon a business career. He accepted a position with Foote & Shear Company, whose business was carried on at the present site of the Weeks Hardware Company. In 1905, when the Ralph E. Weeks Company was organized, Arthur L. Weeks was made secretary of the corporation, and so excellent were his services in this office that at the present time (1914) he fills the dual office of secretary and sales manager, to the satisfaction of all connected with it. They handle all kinds of plumbing and heating supplies and sheet metal products, their business being a most extensive one, some of their patrons coming from great distances. Mr. Weeks is also secretary of the Capouse Warehouse Company. In his political opinions Mr. Weeks is independent, and in religion he is a member of the Elm Park Methodist Church. Fraternally he is a member of Peter Williamson Lodge, Free and Accepted Masons; Lackawanna Chapter, No. 323, R. A. M.; Coeur de Lion Commandery, Knights Templar; Moses Taylor Council, Junior Order of United American Mechanics; and the Young Men's Christian Association.

Mr. Weeks married, in 1907, Grace E., a daughter of James and Sarah (Sergeant) Maycock. James Maycock was one of the pioneer settlers in Slocum Hollow, now Scranton, and was closely identified with the early growth and development of the city. Mr. and Mrs. Weeks have had children: Warren L., born July 1, 1908; Lester J., born February 19, 1912.

---

#### LOWELL MASON GATES, M. S., M. D.

Both the paternal and maternal grandparents of Dr. Gates were pioneer settlers of Pennsylvania, the former of Wayne county, the latter of Susquehanna county. They were of old New England stock, the Gates and Bigelows coming from Massachusetts, the Halls and Lambs from Connecticut. They brought with them to their forest surroundings the spirit of the Puritan forbears, and in their lives exemplified the virtues that in their ancestors made history, of which as a nation, we are proud. Speak slightly as we may of the "Blue Laws," the age that produced them also produced men and women who laid broad and deep the foundation of our nation's greatness, and left an example of self sacrifice, patriotism and godliness that has never been equalled. They so bred their principles into the blood and sinew of their descendants that wherever found they possess those traits of character that make for splendid lives and lofty achievement. Like the Gulf Stream, the New England character is separate and distinct, following along through the broad ocean of life in a well defined course, giving succor and refuge to the storm tossed, and even when far from its source bringing blessings to those dependent on it for even life itself. So this strong Gates blood, transplanted to the wild forests of Pennsylvania, ran so true to all the best instincts of character that for nearly ninety-three years Alpheus W. Gates, father of Dr. Lowell M. Gates, walked the earth, exemplifying in his life the virtues of his sires and leaving a posterity equipped by birth, example and precept to worthily bear the name of Gates and add to it fresh lustre.

Alpheus W. Gates was born in Mount Pleasant, Wayne county, Pennsylv-

vania, July 28, 1820, died in Scranton, February 14, 1913, nearly ninety-three years of age. He spent all but his last years engaged in farming and lumbering, and when he retired from active life came to Scranton, the home of his children. He was a Baptist in religion, a man of pure life, and honored wherever known. He married Semantha, daughter of Major Martin Hall, of Jackson, Susquehanna county, Pennsylvania, a veteran officer of the War of 1812; children: Quincy A., an eminent lawyer of Wilkes-Barre; Lowell Mason, of whom further; Delcie, married J. W. Browning, of Scranton.

Dr. Lowell Mason Gates, second son of Alpheus W. and Semantha (Hall) Gates, was born in Scott township, Wayne county, Pennsylvania, March 26, 1852. After preparatory courses he entered Hillsdale College, Hillsdale, Michigan, whence he was graduated B. S., class of 1876, the same college later conferring the degree of M. S. He then, in pursuance of an ambition long cherished, entered the medical department of the University of Michigan, whence he was graduated M. D., class of 1878. In the two vacations prior to matriculation at Ann Arbor he had read medicine under Dr. O. T. Bundy, of Deposit, New York, and after obtaining his degree he formed a partnership with his former preceptor, practicing in Deposit for eighteen months. In November, 1879, Dr. Gates came to Scranton and established in general practice. After one year he was appointed superintendent and house surgeon of the old Lackawanna Hospital, continuing as such two years, and then resumed private practice, although he was a member of the medical and surgical staff for twenty years, serving until the hospital became a state institution. Dr. Gates has firmly established himself in the regard of the people of Scranton as an honorable and skillful physician, as an affable gentleman and public-spirited citizen. He is with few exceptions the oldest in practice in Scranton. Ever a student, wide reader and deep thinker, he has kept pace with modern progress, and in the practice of his healing art is thoroughly modern. He is held in highest regard by his brethren of the profession, who have chosen him as president of their County Medical Society and vice-president of the Pennsylvania State Medical Society. He is also a member of the American Medical Association, and at their annual meeting in 1913 Dr. Gates sat as representative from the State Medical Society of Pennsylvania. With this public endorsement from his professional brethren, and with the encouragement of a large practice, it is apparent that Dr. Gates is a worthy descendant of his New England progenitors from whom he inherited the qualities that he has cultivated and strengthened, reaching a position of professional excellence and a manly development of character. He is a member of Immanuel Baptist Church, Scranton Board of Trade, and of Lackawanna Lodge, Independent Order of Odd Fellows.

Dr. Gates married (first) Helen, daughter of Rev. Ransom Dunn, D. D., one of the founders and later president of Hillsdale College, Michigan, and for many years head of the theological department. Mrs. Gates was a Hillsdale college classmate of her husband, a graduate, and a woman of great mentality, possessed of every womanly grace. She was a useful worker in the Immanuel Baptist Church; president of the Woman's Missionary Society at the time of her death and of other church activities. She was the organizer and first president of the Young Woman's Christian Association of Scranton, and chairman for many years of the department of Pennsylvania, including also the states of Delaware and Maryland. An eloquent public speaker, in the furtherance of her work she had spoken in every city of Pennsylvania. She was also an able writer, and contributed richly to the literature of her day. On May 25, 1910, her death occurred at the age of fifty-two years. Dr. Gates married (second) in 1912 Mrs. Minnie C. (Bittenhender) Brader, of





*L. M. Gates*





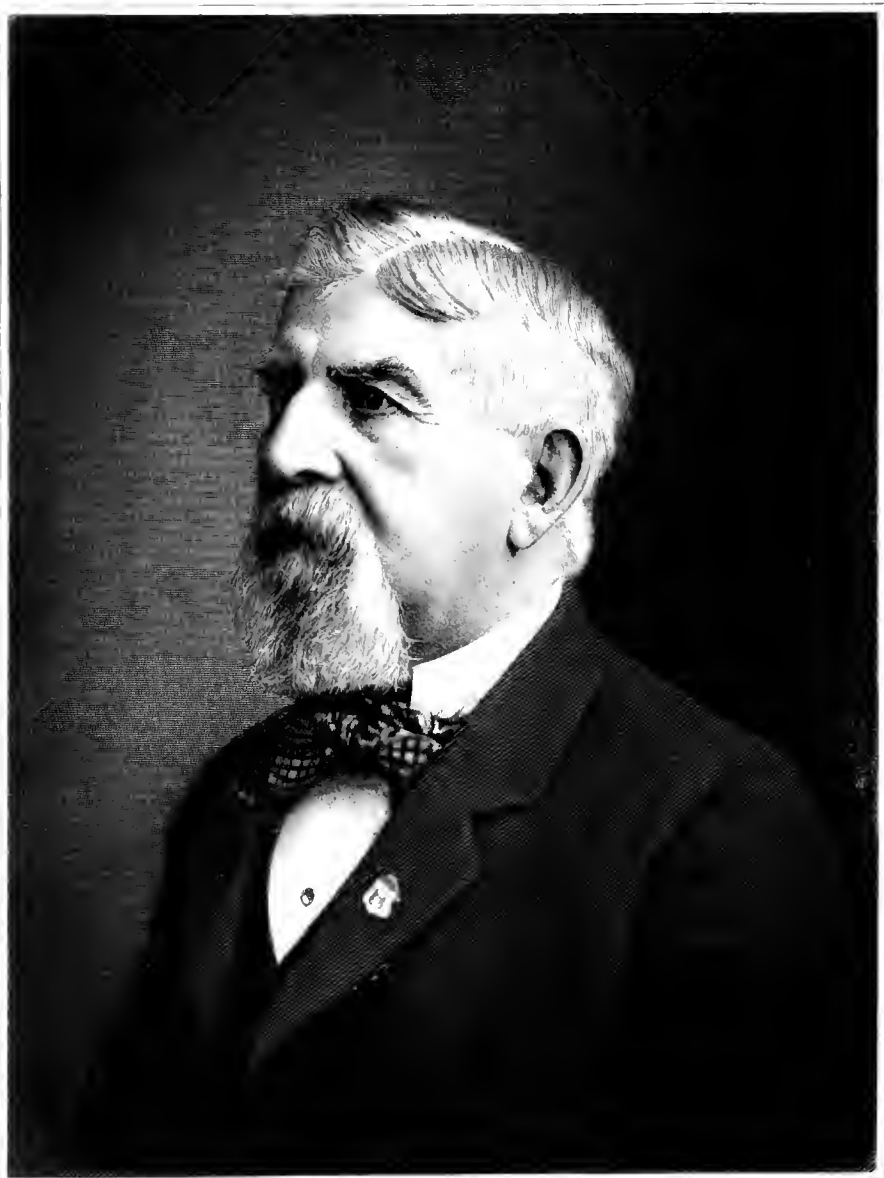

*Nelson Searcy*

Scranton. Children, all by first wife: 1. Wayland D., a graduate of Hillsdale College, and now professor in the Technical High School of Scranton; he received the degree of M. A. from Columbia University, then for three years served as missionary teacher in China, giving part of his attention during this time to the study of the Chinese language; he married Gertrude Pugh, and they have one child, Dorothy. 2. Evelyn, married Forest P. Knapp; he and his wife are graduates of Hillsdale College; he is secretary of the Young Men's Christian Association at Hillsdale, Michigan; they have three children: Delcie, Mildred, Francelia. 3. Helen M., a graduate of Mt. Holyoke College; now teacher in the Allentown College for Women. 4. Edith M., now a student at Oberlin College.

---

### JOHN JERMYN

To write the life record of John Jermyn from the time he arrived in the United States in 1847 to the time of his death in 1902, is to also write a history of the development of the Scranton district. Nor does the record end with his own life, as there are now in the city of Scranton four of his five sons, worthily bearing the name, administering the estate they helped to create, and heading individual enterprises of great importance.

The record of the wonderful life of John Jermyn is more than a chronicle of a successful business man who rose from humble position to one of affluence and influence. He won his own way, it is true, but in winning it he provided for its permanence by inculcating the principles that won, into his sons and in bequeathing to Scranton his family of capable sons he left a richer legacy than his buildings, his mines or his lands. From early life they were his associates and from the example of their sturdy energetic father, and no less capable mother, learned not only the value, but the dignity of labor; became his valued assistants, and when the master mind was stilled forever, they confidently and ably carried on the plans and enterprises that constituted the Jermyn estate in addition to their own private interests.

Little can be told of John Jermyn that is not familiar to every Scrantonian, the impetus he gave to its building movement, his furtherance of industrial development and the progressive character of his operations. He was a hard worker, daring in his plans, but with a confidence in himself that often led him to disregard the caution of his friends. Yet he was unassuming and most democratic in his personal life. The coat-of-arms carried in the furnishings of the Jermyn Hotel are rightfully his, but he relied on himself to create a name and from mines and rocks and lands he builded that name and fortune which endures.

Under the direction of the sons of John Jermyn, every interest of the estate left in their care has been wisely handled, and when in twenty years from the death of the founder the estate shall be divided according to the terms of his will, it will be found that the stewardship of the sons and daughter has been a wise and profitable one. Of the six sons of John Jermyn, four are active, leading business men of Scranton, one resides in New York City, another has gone to his long home, accidentally killed in San Francisco. One of his daughters resides in Scranton, and one in Oswego, New York.

John Jermyn was born in Rendham, Suffolk, England, in 1825, died in Scranton, Pennsylvania, May 29, 1902. Early thrown on his own resources, he made his way to London and at the age of twenty years, with little besides a rugged frame and a stout English heart, came to this country. In 1847 he arrived in New York City and learning of a need for men at Slocum's Hollow, Pennsylvania, (now Scranton) made his way thither. His first day's

work was cleaning up the lawn of the old Platt mansion, then at the old ore mine, now known as Burnt Ridge on the East Mountain. His compensation in these early days was seventy-five cents per day. He soon accumulated a small capital and made some good friends, the result being that he was able to assume the responsibility of small contracts which he executed so faithfully that larger ones followed. One of these was the Diamond Mine, Mr. Jermyn being the first man to strike a pick in that later famous mine. About 1854 he was fully engaged in developing the coal properties of the New York and Pennsylvania Anthracite Coal Companies of Lackawanna county, near the Notch, of which he was general manager, and on its completion, five years later, developed the White Oak, then Archibald, then Jermyn, then Rockwell mines, thus becoming possessed of capital sufficient to justify him in beginning private mining operations. In 1859 he arranged with Judson Clark the terms of an agreement to sink a slope and mine coal on property owned by Mr. Clark on the Abington turnpike, Rockwell mine. On Mr. Clark's death, a few years later, Mr. Jermyn formed a company and leased the mines from the Clark estate, operating for three years as Jermyn, Wells & Company, then abandoning the mines. Then came the leasing of the abandoned mines of the Gibson estate at Rushdale, now the thriving borough of Jermyn, having at present (1914) three thousand three hundred people. These mines had been a failure in the hands of others and Mr. Jermyn's friends strongly remonstrated with him for attempting so great a risk as their reopening. But he had confidence both in the mines and himself and went forward with the undertaking, which proved successful and laid the foundation of his future prosperity. He bought new machinery and in 1862 opened the plant. His first lease was for one million tons, which later he increased to three million tons, and in a few years delivered that amount entire. This placed him among the largest and wealthiest private operators in the valley, and his future career was one of constant acquisition. In 1880 he built and equipped a modern breaker at Rush Brook near Peckville, which the estate still owns. In 1881 he leased the Price tract of nine hundred acres of coal land near Dickson, a section then having but a few houses, now containing thousands and known as the borough of Jermyn. Also after selling out his interest in Priceburgh he started operations in Old Forge borough and the town is now named Rendham in honor of Mr. Jermyn's birth-place in England. About 1882 he opened the Rendham Collieries which are still operated by the Jermyn estate. In 1884 he moved his residence to Scranton which was ever afterwards his home. In 1885 he erected the Coal Exchange Building, and in 1895 built the Hotel Jermyn. He became one of the largest land owners in Scranton and in surrounding towns. With wonderful foresight he chose his lines of operation and made few mistakes. He was identified with many enterprises with others, also conducting extensive private operations. He was public-spirited and in his improvements awakened a great spirit of progress in Scranton. One of his greatest building improvements was the erection, in 1895, of the large hotel that bears his name, and which is yet part of the Jermyn estate. He had, however, begun his building operations much sooner, erecting the Coal Exchange Building in 1885 and followed these with many buildings and residences, including his own at Jefferson and Vine streets. He was a heavy stockholder and a director of the First National Bank, until his death the estate still retaining this valuable interest. He was the principal factor in bringing the New York, Susquehanna & Western Railroad to Scranton, built the line, and in 1886 accepted the general managership of the road. He had many interests and neglected none, working them with his sons' assistance, the eldest, Joseph J., having been his constant associate from boyhood. He was of a generous dis-

position and noted for his hospitality. He never forgot his own humble start and often aided others who were struggling as he struggled. He was not only well known, but well liked, and in accumulating his estate of \$7,000,000, he invoked no governmental favor or special privilege. He fought his own battle in the open and gained an honest victory.

John Jermyn married, October 19, 1851, Susan, daughter of Joseph Knight, of West Scranton. There were no railroads in those days and their wedding trip was a stage coach ride to Pittston and return. Mrs. Jermyn survived her husband three years, dying January 17, 1906, aged seventy-two years. She was a true helpmeet, bore her full share of their earlier burdens and worked hand in hand with her husband to obtain their start in life and foothold on prosperity's ladder. She was kindly, gentle and charitable; very unobtrusive, but very practical in her charities. She was a liberal donor to the Home for the Friendless and to the Woman's Guild of St. Luke's Episcopal Church, of which she was a member for many years. Born in Lostwithal, Cornwall, England, June 12, 1833, she was brought to this country at so early an age that she had little recollection of her English home. Children of John and Susan (Knight) Jermyn: Joseph J., of whom further; William H., died aged nineteen years; Frank H., of whom further; Myron, died aged two years; George B., of whom further; Walter M., of whom further; Edmund B., of whom further; Emma, married D. W. Mears, of Scranton; Susan, married R. A. Downey, of Oswego, New York, president of the Second National Bank there, and vessel owner and grain shipper on the Lakes and a very prominent man in all the affairs of the town, they have two children: Robert A. Jr. and Jermyn; Rollo G., of whom further.

Joseph J. Jermyn, eldest child of John Jermyn, was born in Hyde Park, Pennsylvania, in 1852. He attended the public schools, Kingston Seminary and Bucknell College, but from boyhood was associated with his father, accompanying him to and in the mines when a boy of twelve. He has worked at everything connected with the business, aided in the store, delivered goods to the miners, powder, oil, wick, etc., and has never ceased his activity but conducts large private interests in addition to his duties as executor, chosen under the terms of his father's will to act with his brother, George B., and sister, Emma, to administer the Jermyn estate for twenty years from the date of death of the founder, when it may be divided. He is a man of great energy and public spirit and is recognized as one of the strong men of his city. He is president of the Taylor Bank of Taylor, Pennsylvania; president of the Gulf, Texas & Western Railroad Company; president of the Tintern Manor Water Company, of Long Branch, New Jersey; vice-president of the Traders National Bank of Scranton, is a large mine owner and has a fine stock farm at Greenfield as well as other farm property in the valley. The Tintern Manor Water Company, of which he is owner, consists of a pumping plant on Swimming river, near Red Bank, New Jersey, and one hundred miles of mains extending through Red Bank along the famed Rumson road to Sea Bright, down the coast supplying all the towns as far south as Asbury Park. The franchise is perpetual and the water rate fixed. In acquiring this great property and franchise, Mr. Jermyn had a hard legal battle, but won out against the efforts of some of the officials who sought to effect personal gain. The Gulf, Texas & Western Railroad is also his own property and at present consists of one hundred and thirty miles of well built, perfectly equipped railroad, in Texas, planned to extend west from Dallas and Fort Worth to a connection with the Atchison, Topeka & Santa Fe at Lubbock, three hundred and twenty-five miles west of Dallas. Mr. Jermyn is fond of his horses and stock, taking a great deal of pleasure from the operation of his farm. He belongs to Lodge,

Chapter, Commandery, Shrine and Consistory of the Masonic Order, holding the thirty-second degree. He is a supporter of church and philanthropic institutions and aids in every way the cause of progress.

Frank H. Jermyn, third child of John Jermyn, was born in Scranton, Pennsylvania, in 1858, died in San Francisco, California, January 3, 1910. He was injured in a trolley car collision and died shortly afterward in the hospital. His body was returned to Scranton and rests in Dunmore Cemetery. He had lived in California for about ten years, having purchased Pleasanton Stock Farm, where he gratified his love for fine horses and outdoor life. He sold this farm in 1907 and at the time of his death was living in San Francisco. He was a good, true and manly man, and was highly esteemed by his many friends. He married Grace G. Griffin, who died in April, 1907. Their only daughter, Frances, was educated in music at Berlin, Germany, and married La Mott Belin, of Scranton.

George B. Jermyn, fifth child of John Jermyn, was born in Jermyn, Pennsylvania, May 9, 1862. He was educated in the public schools, "Daddy Merrill's School" and Granville Military Academy, of Granville, New York. After completing his school years he began active business life as manager of the Standard Oil Company's interests in Wilkes-Barre, Pennsylvania, continuing there five years. He then engaged in mercantile business in Rendham, Pennsylvania, continuing until the death of his father in May, 1902. He was appointed under his father's will one of the executors of the Jermyn estate and has since devoted himself to the administration of that trust, although he has large private and corporate interests. He is president of the Scranton Savings and Dime Bank, assistant treasurer of the Gulf, Texas & Western Railroad Company; vice-president, secretary and treasurer of the Hallstead Water Company; vice-president, secretary and treasurer of the Great Bend Water Company; treasurer of the Timern Manor Water Company, Loug Branch, New Jersey; and a director of the Pennsylvania Oral School for Deaf Mutes. He is a member of the Scranton, Press and Country clubs; holds all degrees of Masonry in both York and Scottish Rites up to and including the thirty-second. He is also a Noble of the Mystic Shrine, and a member of the Benevolent and Protective Order of Elks. He is most democratic and public-spirited, believes in the cause of the "public good" and throws the weight of his influence in favor of good government. Most energetic in business, he is a fine type of the successful modern business man. He married, April 20, 1892, Annie Adams, of Fair Haven, Vermont, daughter of Hon. A. W. Adams, the genealogist of the Adams family, now deceased. Children: Margaret, a graduate of Mrs. Dow's Briarcliffe School, and Ruth, aged thirteen years. Mr. Jermyn's residence at No. 616 Webster avenue is a fine Colonial style building, erected by W. H. Taylor, who occupied it but eight months, then moved to New York, leaving his costly residence vacant for ten years until purchased by Mr. Jermyn.

Walter M. Jermyn, sixth child of John Jermyn, was born in Scranton, Pennsylvania, June 2, 1864. He was educated in the Granville Military Academy, and Rensselaer Polytechnic Institute, of Troy, New York, an institution from which he was graduated with the degree of C. E. He was engineer in charge of the Jermyn mining interests, later general superintendent. He then located in Oswego, New York, being president and general manager of the Oswego Boiler Works. After operating that plant for several years he sold out entirely and retired from active business life. His city home is The Great Northern Hotel, New York; his summer home, "Little Grenadier Island," one of the Thousand Islands of the St. Lawrence. He married Lena Kehoe, of Oswego.



Edmund B. Jermyn, seventh child of John Jermyn, was born in Jermyn, Pennsylvania, April 12, 1867. He was educated in public schools, Jermyn public school, Peekskill (New York) Military Academy, Harry Hillman School, Wilkes-Barre, Pennsylvania, and Pierce's Business College, Philadelphia. He began business life in his father's Scranton office, continuing three years, then becoming manager of the grist mill at Jermyn. In 1896 he became manager of the Jermyn mining properties at Old Forge, which is yet his business headquarters. He is president of the Traders Coal Company, of Laffin, Pennsylvania, president of the Archbald Bank of Archbald, Pennsylvania, and has many other private and corporate interests. He was president of the Taylor Hospital, Taylor, Pennsylvania, for seven years and is now chairman of the executive committee. He is a man of energy, has a clear record as a business man, and while never a politician in 1913 led the forces of reform in the battle to obtain the chief magistracy of Scranton. He made his primary fight successfully, and also made a strong plea for a business administration of city affairs. An extract from his letter to the voters is appended: "I would like to be Mayor to demonstrate how easy it is to render better service in every respect to the taxpayer, without any more cost. I want to take hold of the City Hall and run public business as an up-to-date private successful business is run." His wish was granted and he was elected in November, 1913, and is now serving in that office. Mr. Jermyn is a member of all bodies of the Masonic Order in both York and Scottish Rites, including the thirty-second degree, and is a Noble of the Mystic Shrine. He is a member of the Scranton Club, Country Club, Bicycle Club, Engineers Society of Northeastern Pennsylvania, Sportsmen of America, Patriotic Order Sons of America, Crafts Club, Masonic Lodge of West Scranton, Scranton Rod and Gun Club, Wooden Plate Club, of Philadelphia, Pennsylvania, Westmoreland Club of Wilkes-Barre, Pennsylvania, and City Club of Oswego, New York. He married Mary Decker, of Scranton. Children: Edmund B. (2), Princeton, 1915; Elizabeth, married Major Lee White, of Madison, New Jersey, and has a son, Major Lee White (2), born September 18, 1913; William S., a student at Hill's School, Pottstown. The family residence is at No. 621 Jefferson avenue.

Rollo G. Jermyn, tenth child of John Jermyn, was born in Jermyn, Pennsylvania, March 3, 1873. His early education was obtained in the public schools of Jermyn and Scranton, after which he entered St. Paul's School at Garden City, Long Island, whence he was graduated in class of 1892. At the age of eighteen years he began business life as his father's assistant in the Scranton office, having charge of the real estate books for one year. He then was in charge of the Oswego Boiler Works, belonging to the family until their sale in 1903. He then was in charge of an independent telephone line in Syracuse, New York, belonging to his brother Joseph J. until 1905, when the line was sold. Mr. Jermyn then returned to Scranton, and purchased a half interest in the mercantile business of his brother, George B., at Rendham, which he still retains. In 1909 he became treasurer of the Jermyn Hotel, the property of the Jermyn estate. He is a director of the Dime Bank of Wilkes-Barre, Pennsylvania, and has other and varied business interests of importance. Like all the sons of John Jermyn he is gifted with keen business talent and a capacity for work, that accomplishes much without apparent effort. He is a member of Lodge, Chapter and Commandery of the Masonic Order in Oswego, and of Media Temple, Nobles of the Mystic Shrine, of Watertown, New York, also a member of the Benevolent and Protective Order of Elks, of Oswego. His clubs are the Scranton, of which he is director; the Country and Canoe, all of Scranton. In church relation he is a

member of St. Luke's Episcopal Church. Mr. Jermyn married Kate, daughter of Douglass Jay, of Scranton and has a son Rollo G. (2). The family residence is at No. 539 Clay avenue, Scranton.

---

JAMES N. RICE, M. D.

It is certainly within the province of history to commemorate and perpetuate the lives of those men whose careers have been of signal usefulness and honor to the city in which they resided, and in this connection it is not only compatible but absolutely imperative that mention be made of the late Dr. James N. Rice, of Scranton, who was not only an eminent and successful medical practitioner, but an inventor, and one of the most expert authorities in mining operations in the anthracite region of the state of Pennsylvania.

William Rice, father of Dr. James N. Rice, was among the early settlers of Abington, Lackawanna county, Pennsylvania, residing on a farm at Factoryville, which he cultivated and improved, and from which he derived a lucrative means of livelihood. He was a devout Christian, and his advocacy of the cause of temperance was wide and enduring. His death occurred in 1858, and he was survived by his wife, Sarah (Reynolds) Rice, daughter of George Reynolds, who was also among the early settlers of Abington. Mrs. Rice was a woman of great force of character, cultured and refined, a devout member of the Baptist church for forty-six years, and an earnest advocate of the cause of temperance. During the Civil War period her patriotism was most ardent and intense. She survived her husband many years, her death occurring in 1874. She was the mother of seven children: Norman, Edson J., Freelove, Elvira (Mrs. Green), Nicholas E., James N. and Stephen L., three of the sons serving during the Civil War, one of whom, Captain Edson J. Rice, being killed in the battle of Chancellorsville. He entered the service as first lieutenant and participated in nearly all the battles under General McClellan, and also in that at Fredericksburg under General Burnside; he was slightly wounded at Fair Oaks, and was promoted to captain a few months before his untimely but glorious death. The mother met this dreadful affliction with Christian resignation, and found some surcease of sorrow in devoting herself with redoubled energy to the work in which she had been foremost from the beginning, the providing of comfort for the sick and wounded soldiers in the hospital, and of necessities for the families whose bread-earners were at the front.

Dr. James N. Rice was born in Factoryville, Pennsylvania, in 1845, died in Scranton, Pennsylvania, December 9, 1902, after an illness of but a few hours. He attended the public schools in the neighborhood of his home, and later became a student in the medical department of the University of Michigan, at Ann Arbor, from which institution he was graduated, and subsequently took a post-graduate course at the Bellevue Medical College, New York City, from which he graduated in 1867. He began the active practice of his chosen profession in his native town, continuing until 1870, achieving a large degree of success, when he removed to Pittston, Pennsylvania, where he resided for nineteen years, during which time he built up an enviable practice, winning and retaining the confidence and esteem of his many patrons, and a place of prominence among his professional brethren. In addition to his professional career, Dr. Rice was actively interested in the coal industry, to which he had devoted considerable time and attention, and he became the owner of a small mine in Pittston known as the Cork and Bottle, which he operated successfully for a number of years.

In 1889, having decided to change his field of labor and enter upon an en-

tirely different line of work, which he had successfully tried and proven, he removed to Scranton, Pennsylvania, which was his home at the time of his death. At that time he was interested in the development of the property of the Mt. Lookout Coal Company at Wyoming, Pennsylvania, and shortly afterward he organized the Blue Ridge Coal Company, which operated a mine at Peckville, and this he later disposed of to the Ontario & Western Coal Company at an advantageous price. He then directed his attention to the management of the Riverside and West End Coal companies, in the former of which he held a controlling interest, acting as general manager of the latter, each operating one mine. Subsequently he was an active factor in several of the extensive individual coal industries in Lackawanna and Luzerne counties, and at one time was also extensively interested in mining operations in Schuylkill county, Pennsylvania. He attained the same degree of success in this as in his professional labors, owing to his thorough mastery of detail in whatever engaged his attention, and his skill and ability, one of his properties, the Blue Ridge Colliery, being one of the best paying coal properties in the Valley.

Dr. Rice was not only successful as a manager, but was entirely familiar with the conditions and possibilities, making an exhaustive and thorough study of the same, and was recognized as one of the most expert authorities in that locality. President Fowler, of the Ontario & Western Railroad, said of him, that his views with reference to the coal industry were fully four years in advance of the average thought of coal operators. An evidence of his practical ability is afforded in the instance of the coal breaker at Riverside, which was built after his own ideas and under his own supervision, and which enabled twenty boys to secure the same results which had previously required five times that number. He possessed inventive skill of a superior order, which he used to good advantage, one of his inventions, the Rice Coil Carriage Spring, including the machine to make it, being now in general use. This was manufactured in Pittston for a number of years by a company of which he was the head, and later was made by the Columbus Buggy Company. He was interested in the work of the strike commission for the independent mining companies, his influence being ever on the side of right and justice.

Dr. Rice added patriotism to his many excellent characteristics, and at the early age of sixteen years, at the commencement of hostilities between the North and South, he enlisted as a member of Battery L, Second Pennsylvania Artillery, with which he participated in several hard-fought battles, being severely wounded in the battle of Cold Harbor. He served until the expiration of his term of enlistment, his duties being performed in a highly creditable manner, and after his honorable discharge from the service of the United States government he returned to his home and resumed his interrupted studies.

Dr. Rice married, May 9, 1876, Sarah E. Cake, who survived him, maintaining the family home in Scranton, honored and esteemed by all who have the honor of her acquaintance. They were the parents of three children: Homer Cake, Earl Leroy, both of whom inherit in large degree the inventive genius of their honored father, and Marion Helene.

This brief resume of Dr. Rice's many spheres of activity proved the broadness of his mental vision, and whether considered as physician, manager, inventor, employer or soldier, he was found to be a man true to himself and true to his fellows. To a natural dignity of manner Dr. Rice added a geniality that won him hosts of friends and made him welcome everywhere, but he found his principal interest and relaxation in his home, surrounded by his wife and children, to whom he was devotedly attached.

## WILLIAM ALONZO WILCOX

One of the best known lawyers of Wyoming, Luzerne county, Pennsylvania, is William Alonzo Wilcox, who has inherited many of the distinguishing traits of his incestors, the earliest of whom were among the first settlers of New England.

(I) Edward Wilcox, of Portsmouth, and Kingstown, Rhode Island, was one of the free inhabitants of that place in 1638 and was one of those who formed the civil combination or compact of government, May 28, 1638. In partnership with Roger Williams he had a trading house at Narragansett about this time, and prior to 1648 he died, probably at that place. In 1653 there was a guardian for his eight children, among whom was Stephen, of whom further.

(II) Stephen Wilcox, son of Edward Wilcox, born about 1633. He was a resident of Portsmouth, Rhode Island, 1655. He was one of the settlers of Westerly in 1661, and when the town was incorporated in May, 1669, he was among the freemen, and was one of the first delegates to the general assembly, being re-elected in 1672. The old Wilcox farm, near Watch Hill, is still occupied and owned by his descendants. He is mentioned as deceased in a paper dated February 6, 1689-90. Stephen Wilcox married, in the spring of 1658, Hannah, a daughter of Thomas Hazard, of Portsmouth, who came from Wales to Boston about 1635. Children: Edward, of whom further, Thomas, Daniel, William, Stephen, Hannah and Jeremiah.

(III) Edward (2) Wilcox, eldest child of Stephen and Hannah (Hazard) Wilcox, was born about 1662, and administration on his personal estate was granted his widow, November 15, 1715. He was the incumbent of several public offices of responsibility, among them being delegate to the general assembly in 1693. Judging from the inventory of his estate he must have been a man of considerable wealth. He married (first) a daughter of Robert and Mary (Brownell) Hazard, (second) in 1698, Tamzin, daughter of Richard Stevens, of Taunton, Massachusetts. By the first marriage he had: Mary, Hannah, Stephen, of whom further, Edward, and by the second: Sarah, Thomas, Hezekiah, Elisha, Amy, Susannah.

(IV) Stephen (2) Wilcox, son of Edward (2) and ——— (Hazard) Wilcox, left a will dated, January 1, 1753. He married, July 12, 1716, Mercie, a daughter of Matthew and Eleanor Randall, of Westerly. He had children: David, Mercy, Eunice, Stephen, Valentine, Isaiah, of whom further.

(V) Rev. Isaiah Wilcox, son of Stephen (2) and Mercie (Randall) Wilcox, was born in 1738, died March 3, 1793. He was one of the organizers, in 1765, of the Third Church of Christ in Westerly, popularly known as the "Wilcox Church," and was its first pastor, having been ordained February 14, 1771. He married, October 15, 1761, Sarah, daughter of John Lewis, of Westerly, and had twelve children.

(VI) Deacon Isaiah (2) Wilcox, eldest son of Rev. Isaiah (1) and Sarah (Lewis) Wilcox, was born in Westerly, January 31, 1763, died at Newville Herkimer county, New York, July 13, 1844. He was not old enough to enlist in the Continental army at the outbreak of the Revolution, but was accepted in the "Home Guard," made up chiefly of "the undisciplined, the youthful and the aged, spared by inefficiency from the distant ranks of the republic." Colonel William Pendleton was the commander of this brave band, and they rendered efficient service in guarding the coast, and also were engaged in many land skirmishes. He removed with his family to Danube, Herkimer county, in 1792, and was a man of influence in the councils of the Democratic party. He married, January 22, 1788, Polly, daughter of Colonel William





*W. A. Wilcox*

Pendleton, and had: Polly, Isaiah, William Pendleton, Asa, Lydia, Nancy, Nathan Pendleton, of whom further.

(VII) Nathan Pendleton Wilcox, youngest son of Deacon Isaiah (2) and Polly (Pendleton) Wilcox, was born in Danube, New York, May 3, 1804, died April 24, 1833. He was a farmer and contractor, and had already shown much ability as a business man. He married, October 9, 1828, Lurancia, daughter of Lieutenant William and Sarah (Norton) Richardson, and they had one child, Nathan Pendleton, of whom further.

(VIII) Nathan Pendleton (2) Wilcox, only child of Nathan Pendleton (1) and Lurancia (Richardson) Wilcox, was born at Nunda, New York, May 16, 1832, died at Nicholson, Pennsylvania, April 25, 1904. His education was a liberal one, and upon its completion he was engaged in teaching in McKean county, Pennsylvania, in 1847-48 and 1852-53. From 1848 to 1852 he was also employed in the store of his uncle, Jeremiah W. Richardson, at Nunda, then was with Smith Brothers and N. S. Butler, in Olean, New York. In 1856-57 he was senior member of the mercantile firm of N. P. Wilcox & Company, the junior member being J. K. Comstock, and in 1858, in association with Frederick Eaton, formed the firm of Wilcox & Eaton, continuing until 1862. He removed to Nicholson, Wyoming county, Pennsylvania, in the spring of 1862, and was a merchant there until 1886. He was very prominent in church affairs, and was chosen one of the ruling elders of the Presbyterian church at Nicholson when it was organized. He was a teacher in and superintendent of the Sabbath school, and had charge of an adult Bible class. Politically he was a Democrat always, and filled, very efficiently, a number of local offices, among them that of magistrate and surveyor. Mr. Wilcox married, October 6, 1856, Celestine, daughter of John and Nancy (Little) Birge, of Coventry, Chenango county, New York, and they had children: William Alonzo, of whom further; Henry Pendleton, in the mercantile business at Nicholson; Clara B.; Anna J.

(IX) William Alonzo Wilcox, son of the late Nathan Pendleton (2) and Celestine (Birge) Wilcox, was born July 25, 1857, at Olean, New York, where his father was a merchant. The son attended Keystone Academy in 1874 and 1875; taught "the Hack School" in Benton the winter of 1875-76; was employed in his father's hardware store in 1876 and 1877, and studied law in Tunkhannock in 1878 and 1879 with Robert R. Little and his sons, William Ernest and Clarence A. Little. He was admitted to the bar of Wyoming county in January, 1880; in Lackawanna county the same month, and opened an office in Scranton, where he has since continued. He was admitted to the Supreme Court of Pennsylvania in 1882. His residence was with his parents at Nicholson until his marriage in 1885. In the first Pattison campaign (1882) he was chairman of the Democratic county committee and secured the largest Democratic vote and majority in the history of Wyoming county before or since. He is a past master of Nicholson Lodge, Free and Accepted Masons, and past high priest of Factoryville Chapter, Royal Arch Masons.

Mr. Wilcox has served many years as a director of the Lackawanna Law and Library Association; was an incorporator of the Pennsylvania Bar Association; member of the American Bar Association; organized the Farmers National Bank of Montrose, of which he was many years a director; is a corresponding member of Wyoming Historical & Geological Society at Wilkes-Barre; a vice-president and prominent in Wyoming Commemorative Association; was a ruling elder in Presbyterian church in Wyoming while resident there; was title officer and trust officer of The Title Guaranty & Trust Company and trust officer of The Scranton Trust Company for many years; pub-

lished a volume of law reports, a Wilcox-Brown-Medbery genealogy; some historical addresses, etc. He has been president of the New England Society of Northeastern Pennsylvania; was given the degree A. M. by Hamilton College in 1908; is now president of the Waterloo Water Company (Seneca county, New York) and (1914) chairman of the Democratic county committee of Lackawanna county. He assisted Colonel Hitchcock in the preparation of portions of this history—the chapter on the Bench and Bar is largely from his pen.

Mr. Wilcox married, April 22, 1885, Katharine J., youngest daughter of Hon. Steuben and Catharine (Breese) Jenkins, of Wyoming. The children of this marriage are: William Jenkins, A. M. (Hamilton) LL. B. (Washington and Lee), a member of the Lackawanna bar; Emily (Mt. Holyoke); Helen, and twins, Stephen and Henry, born 1898, died young. The first two children were born at Wyoming; the latter three at Scranton. Mrs. Katharine J. Wilcox died at Lake Winola, September 3, 1913.

---

#### CHARLES F. MILLER

Massachusetts, New York and Pennsylvania are the states that have been graced by the residences of this branch of the Miller family, settled in Massachusetts at an early period in Colonial history, some of the family members of the band of Puritans that founded the Massachusetts Bay Colony. In England those of the name bore an honorable record and in the rolls of the volunteer regiments raised in Massachusetts to throw off the dominion of the King of England, the name Miller appears with a frequency that eloquently attests their patriotism and sturdy independence. Nor was such spirit lacking in the maternal forbears of Charles F. Miller, of this chronicle, for the Van Olindas, of Holland ancestry in both lines of the family, were also numerousy represented in the Revolutionary War. In the later war that has distressed our nation, the struggle between the North and the South, three Miller brothers served in the Northern army, one of whom was Milton, father of C. F. Miller. He was a first lieutenant in a company of the One Hundred and Forty-ninth Regiment New York Volunteers, participating in all the campaigns in which that regiment was in action from the declaration of war until the signing of the articles of peace. Milton Miller came from Wales, Massachusetts, to New York, in which state his son, Charles F., was born.

Charles F. Miller was born on a farm at Brewerton, New York, and obtained his entire graded education in the common schools of the locality. When he was twenty-three years of age he engaged in independent business, for a time conducting farming operations, after which, until he was thirty-six years old, he was a manufacturer, continuing in this line for nine years. He then entered the law office of Newell & Chapman, of Syracuse, New York, as a student, but after a short time decided against the legal profession and secured an engagement in the journalistic field, becoming connected with the advertising department of the Syracuse Post Standard, and for some time was a well regarded member of the staff of that paper. After leaving the employ of that periodical, Mr. Miller formed association with the Boyd Publishing Company of Syracuse, remaining with that firm until 1899, when he resigned his position and moved to Scranton. Here he established in the publishing business, his first work being the publication of a pamphlet of mine laws, of which more than 100,000 copies were distributed in the adjacent mining regions. This pamphlet, reproducing in full and interpreting all legislation enacted on this subject performed a great work in enlightening the native and foreign mine workers as to the obligations and responsibilities of both







*J. W. Sando.*

employer and employed, and received the hearty commendation of the press, those interested in humanitarian projects and the general public. In 1903 Mr. Miller began the publication of the Board of Trade Journal, at the time one of three publications of its kind in the United States, the two others being published in Portland, Maine, and at Providence, Rhode Island. He is still the editor and proprietor of this periodical, which is of valuable assistance to the administration and to those interested in the welfare and advancement of Scranton's industrial expansion and development. The strength and power of this journal, universally recognized as one of the most progressive municipal publications in the country, is in large measure due to its skillful guidance, judicious editing and careful arrangement by Mr. Miller, who places in its pages much of his own spirit of progress and action.

Besides his affiliations with the Board of Trade, Mr. Miller is a member of the Masonic fraternity, being a thirty-second degree Mason and member of Irem Temple, Mystic Shrine, the Engineers' Club, and is past commander of the local organization of the Sons of Veterans. In his contact with the business men of Scranton, Mr. Miller has made many firm friends, and is accepted by all in social or business circles as an earnest and disinterested worker for the city's best good.

---

#### JUDGE MICHAEL FRANCIS SANDO

Dating in the United States from the year 1826 and from the early pioneer days of Pottsville, Pennsylvania, the Sandos have occupied prominent place in their communities. The emigrant, Michael Sando, was born in Cornwall, England, and there passed his early life, becoming a practical deep mine worker in the famous mines of his native shire. In 1826 he came to the United States, settling in Pottsville, Pennsylvania, being one of the early settlers there. He became one of the first coal operators of that district, beginning at a date prior to the coming of the railroads. The coal he mined in the earlier days was marketed in Philadelphia, but was transported by wagon and teams. For the first twenty-seven years in Pottsville district he was general superintendent of mines for others, but later engaged in the same business for himself. He was successful and ere the close of his sixty-nine years of life was able to retire with a competence. He married Jane Gould, born in Devonshire, England, died in 1884, aged ninety-three years, retaining excellent health and full mental powers until her last short but fatal illness. Two of the children of Michael and Jane Sando are yet living—Joseph W. was the youngest and the only son.

Joseph W. Sando was born in Coal Castle, Schuylkill county, Pennsylvania, December 2, 1835. He attended the public schools until sixteen years of age, then began active business life as a lumberman, working in the woods and for a time in a saw mill as sawyer. After two years spent in this manner, he began a regular apprenticeship at the machinist's trade with the Orchard Iron Works at Pottsville. He served three years as apprentice, then two additional years were spent as journeyman with the same company. In August, 1859, he located in Scranton, obtaining employment as machinist with the Dickson Manufacturing Company, then engaged in the building of locomotives, stationary engines, mining machinery, boilers, etc. He continued as journeyman machinist until 1872, when he was promoted foreman of the machinery department, holding that position twenty-four years, earning the fullest confidence of his employers and the respect of the men over whom he had control. The position he capably filled, was one of great responsibility, demanding not only mechanical skill beyond that of any of his men, but tact and a high

order of managerial ability. These qualities Mr. Sando possessed and in his twenty-four years as foreman he proved equal to every emergency, meeting every demand made upon him and establishing for his department a high record of efficiency. In July, 1896, the management of the company passed into other hands, and Mr. Sando, having reached the age of sixty-one years, resigned his position and retired from active business life. He had played well his part and in his own sphere had rendered important service to his adopted city. In his political belief Mr. Sando is a Democrat, but is not radical or partisan. He is a communicant of the Roman Catholic church, attending Saint Peter's Cathedral with his family. Mr. Sando married Mary Grogan; children: Michael F., of whom further; William J., a mechanical engineer.

Judge Michael Francis Sando was born in Scranton, Pennsylvania, May 8, 1862. He was educated in the city schools, finishing at the high school, whence he was graduated in class of 1879. He decided upon the profession of law, preparing therefor under the preceptorship of W. H. Gearhart, an attorney of Scranton. Completing the course of study and passing the required examination he was admitted to the Lackawanna county bar in 1883 and at once began the practice of his profession in Scranton, and so continued until his elevation to the bench in 1902. From his early manhood, Judge Sando was active in the Democratic party and an effective party worker. For about fourteen years he was a member of the county and city political committees, was delegate to state conventions and from 1885 until 1888 was deputy collector of internal revenue. He was twice elected to the state legislature, serving from 1888 to 1892. While a member of the house he served on committees: Appropriations, municipal corporations and judiciary general. In 1898 he was the candidate of his party for Congress from the Eleventh Congressional District, but failed to secure the election. He continued the private practice of law, was admitted to practice in all state and federal courts of the district and was in command of a good law practice. In 1902 he was nominated for judge of the Orphans' Court of Lackawanna county and at the following November election was the successful candidate. He assumed his judicial duties, January 1, 1903, and is still the honored judge of that branch of the county judicial system. He had presided over the sessions of the Orphans' Court with fairness, justice and dignity, and has so far as able expedited the important business of his court without doing any injustice to those dependent upon his decisions or rulings. He has earned the title of a "just judge" and is held in highest esteem by his brethren of the bar. In religious faith he is a Roman Catholic, an attendant of Saint Peter's Cathedral, Scranton.

Judge Sando married, in Scranton, August 28, 1885, Anna L. Blair; children: Joseph B. and Francis B.

---

#### JAMES EDWARD BURR

Member of a distinguished New England family that found its way to Pennsylvania by way of New York, James Edward Burr, of Scranton, is a native of the former state and has been a prominent legal practitioner of Lackawanna county ever since the formation of that political division. The family of Burr is one whose members have ever held high position among their fellows, one of the famous historical characters belonging thereto being Aaron Burr.

(1) James Edward Burr is a grandson of Isaac Burr, a native of Fairfield, Connecticut, a surveyor and land agent, who married Deborah Raymond,

of Norwalk, Connecticut, and had children: 1. Dr. George, practiced the medical profession first in Ohio and later in Binghamton, New York; married Eunice Swift, and was the father of Dr. Daniel S., of Binghamton, New York, and George M., a prominent banker and lumber merchant of Manistee, Michigan. 2. Dr. Charles, a physician of Carbondale, Pennsylvania; married Lenora Farrer, and was the father of Charles R. and Mary. 3. Isaac, of Meredith, New York; married a widow, Mrs. Elizabeth Johnston. 4. Raymond, died in Columbus, Ohio; married Elizabeth Runyon. 5. Elizabeth, married Rev. Crispus Wright, a minister of the Presbyterian church. 6. Jane, married Orrin Porter, deceased, of Delaware county, New York. 7. Washington, of whom further.

(II) Washington Burr, son of Isaac and Deborah (Raymond) Burr, was born in Meredith, Delaware county, New York, in August, 1824. He was a jeweler and watch-maker, conducting retail dealings along these lines until his death, the business that he founded now managed by his son, Frank E. He married Lucinda, daughter of Elbert Bradley, of Carbondale, Pennsylvania, and had two sons, James Edward, of whom further; Frank E., of whom further.

(III) James Edward Burr, son of Washington and Lucinda (Bradley) Burr, was born in Carbondale, Lackawanna county, Pennsylvania, July 8, 1852. After completing courses in the public school and preparatory schools, he matriculated at Princeton University, of which one of his ancestors had been president at an early date, and in 1875 was graduated A. B., afterward receiving the degree of M. A. He then became a student at law in the office of E. P. and J. B. Darling, of Wilkes-Barre, Pennsylvania, and in 1877 was admitted to the bar. Mr. Burr was one of the first lawyers to engage in practice at the bar of Lackawanna county, being admitted thereto immediately after the erection of the county. Since coming to Scranton he has been retained as counsel in many important cases. Mr. Burr is a member of the Scranton Club and of the Princeton Club, of New York. His church is the First Presbyterian, of Scranton, and he was formerly a member of the session of the First Church of that denomination at Carbondale.

Mr. Burr married (first) Matilda Parsons, daughter of Rev. Edward Bryan, of Carbondale, Pennsylvania; (second) Harriet A., daughter of Le Grange Hulse, of Middletown, New York, and widow of Dean H. Bassett, of Carbondale, Pennsylvania. Children of his first marriage: 1. Sarah, married Philip Coan, a member of the editorial staff of the New York Evening Sun, and has one son, Philip, and a daughter, Leonie. 2. Edward Bryan, married Amber Jadwin, daughter of J. S. Jadwin, of Carbondale. 3. Lily Paxton, married Donald Bassett, of Carbondale. 4. Kathryn Meigs, married Robert A. Gardner, of Scranton. Mr. Burr is the father of one daughter by his second marriage, Constance Hulse.

---

#### FRANK E. BURR

A farsighted business man and a progressive, public spirited citizen is Frank E. Burr, proprietor of the leading jewelry store of Carbondale, Lackawanna county, Pennsylvania.

Frank E. Burr was born in Carbondale in January, 1862, son of Washington Burr (q. v.), and received a substantial education in the public schools of his native city. Upon the completion of his education, he became associated with his father in the business founded by the latter, and upon the death of the senior member of the firm assumed sole control and has conducted this business successfully up to the present time. The store is located at No. 35

North Main street, in a building erected by the elder Mr. Burr, and now owned by Frank E. Burr. Mr. Burr is possessed of a remarkable degree of energy and executive ability, and keeps his business up-to-date in every particular, and is the originator of a number of novel ideas. He is also interested in a number of other business concerns, among them being the First National Bank, in which he is a stockholder. He affiliates with the Republican party, and is a member of the First Presbyterian Church. Fraternally he is a Mason, having passed through all the degrees up to that of the Shrine. He married Grace McMillan, daughter of James and Jean (Maxwell) McMillan; of Carbondale; children: Marion Grace, married Joseph Winter Johnston, and Betty J.

---

#### HON. WILLIAM J. LEWIS

The Hon. William J. Lewis, deceased, of Scranton, was one who in his life stood conspicuously in the community as a splendid exemplification of noble manhood. He was among the foremost men of affairs in the city, actively identified with numerous commercial and financial interests which were strong factors for the general welfare. With lofty conceptions of the duties of citizenship, he ever exercised his influence in behalf of that which was demanded by the highest standards of conduct both in personal and official life. He served the state and the community in important positions with signal ability and unblemished integrity. In his purely personal character he was an ideal Christian gentleman. He was a son of John D. Lewis, and a grandson of David J. Lewis, who came to the United States from Wales and died in Carbondale aged seventy-six years.

John D. Lewis, whose experience as a practical miner made his services of great value, was of material assistance in developing the coal industry in Carbondale and its vicinity. Some years were spent in the employ of the Delaware and Hudson Canal Company, but he abandoned mining in 1858 and engaged in farming in Clifford township, Susquehanna county, Pennsylvania. He again made his home in Carbondale in 1866, when he retired from strenuous work. After the death of his wife, ten years later, he removed to Scranton, where he lived with his son, William J., until his death in May, 1880, at the age of seventy-three years. He married Anna Hopkins, who like himself was born in Wales, and died in Carbondale, in March, 1876, aged seventy-six years. They had children: David, who went to California in 1852; Lewis, died in 1860; Gwennie, died in 1856; John F., in the employ of the American Safety Lamp and Mine Supply Company, in Scranton; Thomas, lives in San Francisco, California; Margaret E. Kenvin, also lives in San Francisco; William J., of this sketch.

Hon. William J. Lewis was born in Carbondale, Lackawanna county, Pennsylvania, August 27, 1843, died in Scranton, January 25, 1902. The family was a fairly numerous one, and it became necessary for even the youngest child of the family to lend his assistance in its support. Accordingly, when he was but nine years of age, he commenced working in the mines, but as this occupation did not appeal to him, he accepted a position on a farm quite far from his home. When his father bought the farm in Clifford township, young Lewis was his assistant in its cultivation. In the fall of 1862 he could no longer resist the calls of patriotism and enlisted in Company B, One Hundred and Seventy-seventh Regiment Pennsylvania Volunteer Infantry, for a nine months' term. During the term of his enlistment he was mainly in Virginia, but when the battle of Gettysburg was about to be fought, this regiment made a forced march in order to reach the scene of this conflict. They

were not in time to render any assistance in the fighting, but did excellent service, as a part of General Slocum's corps, in pursuing the enemy in their retreat to the south. In September, 1863, Mr. Lewis was honorably discharged with his regiment, which was commended for its bravery and courage. While Mr. Lewis had attended school but a few years, he had spent all of his spare time in study and wide and diversified reading, and was well equipped for the profession of teaching, which he now followed for a time with great success. The school terms, however, were extremely short ones, and the pay moderate. The work in the coal mines was uncongenial labor, but it was comparatively well paid, and the means thus acquired could then be utilized for some other advance in life. Having well considered these matters, Mr. Lewis, in 1864, with his brother, John F., engaged in mining in Jermyrn. He followed this two years, then removed to Scranton where he opened a general merchantile business in the Providence section of the city. After a short time he sold this and opened a hardware store in the same section, under the firm name of Lewis & Fish, at the end of two years bought out the interests of his partner, and continued it alone for a further five years. In spite of strenuous labor this business was not the success which the efforts of Mr. Lewis would have warranted, and he lost the entire capital he had invested. He then embarked in business as an insurance agent and conveyancer, and built up a large enterprise.

Mr. Lewis had been appointed paymaster of the Ninth Regiment, National Guard of Pennsylvania, in 1875 by Governor Hartranft, an appointment which was in the nature of honor paid to his ability and integrity, as it involved heavy responsibilities, but was very poorly paid. The same governor, in 1879, appointed him as one of the first auditors of Lackawanna county, but Mr. Lewis declined this office. When Lackawanna county was separated from Luzerne county, Mr. Lewis was appointed associate judge, and held court for a period of five years in Washington Hall, on Lackawanna avenue, in association with Judges Handley, Hand and Moffit. Under the provisions of the new constitution this office was then abolished, and in 1885, after a hotly contested election, he was made sheriff of the county by a Republican plurality of one thousand votes, a fine testimony to his personal popularity, as the section was a strongly Democratic one. During his term of three years, which commenced January 1, 1886, Mr. Lewis made the banner record for efficiency in that office. In 1889, after the failure of the Scranton City Bank, Judge Lewis, representing the depositors, and Dr. Throop, representing the stockholders, were appointed trustees of the property then known as the "Jessup leases," and it was largely due to his financial ability that the depositors were paid in a comparatively short time. His financial and executive ability having been thus publicly demonstrated, Mr. Lewis became a director and the general manager of the New York, Susquehanna & Western Coal Company, October 1, 1890. This controlled the output of eighteen breakers, and was under the charge of Mr. Lewis until merged with the Erie Company. Other important enterprises also claimed his time and attention. He was chosen president of the Susquehanna Connecting Railroad Company, of which he had been one of the incorporators, in 1896; a leading spirit in the organization of the North Scranton Bank, its first president, and was still holding this office at the time of his death; president of the Lackawanna Telephone Company of Scranton; a director in the Dime Deposit and Discount Bank; and was officially and otherwise connected with other institutions and enterprises in Scranton and its vicinity.

In political opinion he always sided with the Republican party, and cast his first vote for President Lincoln. At various times he served on state and

county committees, and sat as a delegate in the conventions of his party. He was a thirty-second degree Mason but later resigned from all the bodies of this order with the exception of Hiram Lodge, No. 261, of which he was a life member. He was an active member of Griffin Post, No. 139, G. A. R. He was one of the organizers of the North End Board of Trade, and served as president of the body until he positively declined re-election. His connection with the Providence Presbyterian Church was a most meritorious one. He served fifteen years as a member of the board of trustees, during this time was chairman of this body, a part of this time being the years when the new church was erected. Generous as he was in his contributions to this worthy object, the physical and moral support he gave to this undertaking was of incalculable benefit, as he was rarely absent from morning and evening service. It was said of him: "he was a regular, devout and reverent worshiper in God's house on the Sabbath day, and was a Christian man of a rare type of excellence. His fervent belief in God and Christ, and his faith in prayer, were real things to him. He practiced religion in his daily walk and conversation."

Judge Lewis married (first) December 31, 1863, Adeline Wells, a native of Susquehanna county, who died there April 14, 1864. He married (second) in Scranton, in March, 1867, Cassandra, daughter of William Bloss, a contractor and builder, and a member of an old Pennsylvania family. She died May 30, 1877, leaving two children: William J. Jr., whose sketch follows; Effa, who married Arja Powell. He married (third) June 2, 1882, Mary Griffith, a native of Wales. They had three sons, one of whom died at the age of two years, another at three years of age, and the third is Walford C. No more fitting or accurate estimate can be given of the character of Mr. Lewis than is to be found in the resolutions adopted by the board of directors of the bank of which he had been president so long a time. They were in part as follows:

A manly man, Christian gentleman, the president of this bank, is dead—William J. Lewis, for many years a resident of North Scranton. We all knew the life he led. To this community it was a benediction, and to all of his neighbors an inspiration. Right minded, strong and courageous in his convictions from a proper sense of duty, he never wavered. Bright and cheerful in disposition, his presence on any occasion was grateful, his unexpected or enforced absence invariably deplored. Rare, indeed, was his personality. The heart and the head each seemed to play an equal part, the one compelling respect and admiration by the exercise of its powers; the other inspiring love and devotion by the exhibition of its virtues. As a neighbor he was hospitable to all, and kind to the poor. A man of affairs, and exceptionally wide experience, in both private and public life, he was honest and true to the best and highest ideals. From the organization of the North Scranton Bank until the hour of his untimely death, he was president of the institution. A member of our board of directors, he was sagacious and conservative in consultation. The highest executive officer of the bank, no detail of its business escaped his notice, nor did any matter appear too trifling to claim his attention. Not a little of the bank's present highly satisfactory condition, not a little of its promising future, is to be attributed to his indefatigable and unselfish devotion to its interests. And now, finally, it may be said of him that he was a man of many friends and no enemies.

---

#### WILLIAM J. LEWIS JR.

The name that heads this chronicle is one that in a past generation was familiar to and its bearer loved by a wide circle in Lackawanna county, and in the present day designates one who is a worthy successor of his sire. William J. is the son of William J. (q. v.) and Cassandra (Bloss) Lewis.

William J. Lewis Jr. was born in Scranton, Pennsylvania, August 27, 1869, and after obtaining a public schools education began work in the mines of the region. He was active in the construction of the Suburban Railroad



and Electric Line, for a year and a half having control of its operation. He operated one of the first street cars used in Scranton, and when the electric road supplanted the Peoples Road he became associated with the former. When he was nineteen years of age he was the principal factor in the organization of the first union of street car men formed in Scranton, and the second in the United States, the other being in New York City, and after the affiliation of this organization with the Knights of Labor Mr. Lewis became worthy master of the lodge. For two years he was a clerk in an establishment at Providence, resigning to take a course in Wood's Business College, and while attending this institution he studied practical electricity, and later installed the first electric hoisting signal service in Leggett's Creek Mine, owned by the Delaware & Hudson Company. He was then appointed weighmaster for the New York, Susquehanna & Western Coal Company, serving in this capacity for three years, at the end of that time becoming assistant general coal inspector, continuing so for four years. The following year he passed in Mauch Chunk as a motorman, and was then offered the superintendency of the Mauch Chunk Power Plant, which he accepted and held for two years. He then returned to his native city and was connected with the New York, Susquehanna & Western Coal Company as assistant general coal inspector until that concern was absorbed by the Erie Railroad. Remaining in the same line he became weighmaster at Johnson's No. 2 Colliery, owned by the New York, Ontario & Western Railroad, later aiding in the organization of the Williams Drop Forge Company, of which he was secretary and treasurer for five years. His present occupation is insurance and real estate dealing, and he is also interested in advertising novelties and specialties, in both of which lines he has met with success, in the latter having a reputation for the originality and attractiveness of the plans and novelties he has introduced. Mr. Lewis holds the thirty-second degree in the Masonic Order, belonging to Union Lodge, No. 291, Keystone Consistory, and to Irem Temple, Nobles of the Mystic Shrine, and holds membership in the Modern Woodmen of America, the Benevolent Order of Beavers, Lodge No. 150, the Commercial Travelers of Utica, and S. of V. Camp, No. 8, of Scranton.

Mr. Lewis married, in 1902, Margaret A. Williams, daughter of John F. and Margaret A. (Roberts) Williams, of Peckville, Pennsylvania. Children: Cassandra B., Margaret A. and Effie; also Amanda, who died in infancy.

---

#### ALFRED L. DERRY

Walsall, Staffordshire, England, is the birthplace of Alfred L. Derry and the home of his ancestors, his grandfather, John Derry, having been born there. John Derry was a brick manufacturer of Walsall, England, continuing in that line throughout his long career, his death occurring at the advanced age of ninety-seven years, his wife, Martha, dying when she had attained the wonderful age of one hundred and one years, husband and wife presenting remarkable cases of longevity. They are buried near their home. Both were members of the Methodist Episcopal church. They were the parents of William, Henry, John, of whom further.

(II) John (2) Derry, son of John (1) and Martha Derry, was born in Walsall, England, and for many years was an iron master in a furnace at Bentley, England. He immigrated to the United States after his second marriage, and settling in Scranton, Pennsylvania, he became a brick manufacturer and building contractor, afterward moving to Covington, Kentucky, remaining in that place until his death, aged ninety-six years, the family trait of long life prevailing in him. He was the successor in the brick business of McKeever

Brothers, at Minooka, Pennsylvania, and with Jerry Williams erected the original buildings of the Sarquoit Mills, then owned by Harvey Brothers. He superintended the erection of many buildings in Scranton, and was likewise in charge of the first street grading done in that city, on the Genett Estate, on what is known as the South Side. He was a man of excellent education, and was at one time a local preacher of the Methodist Episcopal church. John Derry attained prominence and influence in the Scranton district, having risen to this position by the tireless application of the talents with which he was endowed, energy, industry, persistence, perseverance and the faculty of seizing opportunity at its flood. He was held in high esteem by those with whom he associated, and died as he had lived during his long life, loved, honored and respected.

He married (first) at Walsall, England, Anna Jordon, a native of that place, who died aged forty-eight years, and is buried in England; (second) Anne Dash, a native of England. Children of first marriage: Stephen, John, Alfred L., of whom further, Clara, Mary Ann. Children of second marriage: Jasper, resides in Cincinnati, Ohio; Clarence, lives in Cleveland, Ohio; Anna, married Herbert Yewell, of Chicago, Illinois; Nellie, married D. R. Burley, and resides in High Spring, Florida.

(III) Alfred L. Derry, son of John (2) and his first wife Anna (Jordon) Derry, was born in Walsall, Staffordshire, England, July 9, 1856, and was there reared until he was ten years of age, when he was brought to Pennsylvania by his parents. His education begun in his native land, was continued in his new place of abode, and as a youth he became employed in the breaker at the Meadow Brook Mines, owned by William Connell, later being transferred to clerk duty in the store of the company. For the twelve following years he was clerk in the Scranton Post Office, and then, until 1900, was employed as a commercial traveler. Since 1900 Mr. Derry has been engaged in railroad contractors' supplies, his office in the Connell Building, and in this line he has been successful in gratifying measure, directing a business substantial and lucrative, the prosperity of which is due to his strenuous efforts in its founding. Mr. Derry is prominent in the Masonic Order, holding the thirty-second degree, and belongs to Peter Williamson Lodge, No. 323, F. and A. M., of which he is past master; Lackawanna Chapter, No. 185, R. A. M.; Scranton Council, No. 44, R. and S. M.; Coeur de Lion Commandery, No. 17, K. T.; Keystone Consistory, Sovereign Princes of the Royal Secret; and Irem Temple, Ancient Arabic Order Nobles of the Mystic Shrine. His political faith is Republican, and he is a member of the Christian Science church.

Mr. Derry married, October 14, 1880, Harriet M., born in Scranton, daughter of Charles C. and Southard Rogers, and has children: Ralph B., Charles R., Walter T., Wesley A., Florence J., married Rothell K. Coan, of Scranton, and has one daughter, Jeannette Grace. The family residence is at No. 442 Colfax avenue, Scranton, where he built a house in 1900.

---

#### THOMAS F. WELLS

Following in the footsteps of his father, Corydon H. Wells, who located in Scranton in 1854, Thomas F. Wells has in his profession and in his devotion to the church honorably filled the place left vacant in both by the death of his honored sire. The career of the elder Wells began in Scranton with the early days and covered activities as merchant, insurance agent and lawyer. He was successful in all, and two of the large fire insurance agencies of to-day were founded by him. The career of the son covers thirty-eight

years of successful legal practice in the city, and nearly sixty years continuous residence, dating from 1854, the year succeeding his birth.

Corydon H. Wells was born in Dundaff, Susquehanna county, Pennsylvania, died in Scranton, in 1888, aged sixty-two years. He was educated in the public schools and Waverly Academy, beginning business life in Scranton in 1854 in partnership with his brother-in-law, George F. Bass, the firm trading as Wells & Bass. He was married prior to coming to Scranton, where he did not long continue in mercantile life. He was elected justice of the peace and during his incumbency of that office studied law, one of his preceptors being Colonel Wright, of Wilkes-Barre. He was admitted to the bar and at once began practice in Scranton. During his early years in practice he also conducted a fire insurance business, the present important agencies of R. W. Luce & Son and W. W. Phillips & Company having been established by Mr. Wells during this period. He gained in reputation as an able lawyer, and as practice increased he withdrew from the insurance field. He practiced alone until the admission of his son, Thomas F. Wells, to the bar, then they became partners, an association that continued until a few years prior to the death of Mr. Wells Sr. He was elected a member of the board of city assessors, but before he had entered upon the duties of that office death ended the useful career, council electing his son, Thomas F., to fill his place on the board. He was a member of the Washburn Street Presbyterian Church, which he joined after his marriage, his wife being one of the original members of that congregation. He was clerk of sessions for many years, and an elder, taking a deep interest in the welfare of the church and actively engaging in its up-building. Corydon H. Wells married Mary G., daughter of Thomas H. and Ann (Chittenden) Bass, of Pleasant Mount; children: Thomas F.; Jennie R., wife of Rev. William Irwin Steans, D. D., of Westfield, New Jersey.

Thomas F. Wells was born in Dundaff, Susquehanna county, Pennsylvania, September 17, 1853. He was about one year old when his parents moved to Scranton, which has ever since been his home. He attended the public schools of the city, and after due preparation entered Lafayette College, class of 1874. He chose his father's profession, studying in the office of Hand & Post, of Scranton, and after passing satisfactory examination was admitted to the Luzerne county bar in 1875. He was at once admitted to a partnership with his father, who had a well established practice and together they continued until a few years prior to the death of the senior partner. Mr. Wells has been admitted to all state and federal courts of the district and has an extensive civil practice, large corporate and orphans' court business. He is a thoroughly capable and reliable lawyer and has gained high standing among his professional brethren and with a class of most desirable clients. Mr. Wells has also allied himself with several of Scranton's industries and holds directorships in the Spencer Heater Company, the J. A. Breman Drilling Company, the Wolf Creek Coal Company, the Lackawanna Mountain Ice Company, the Lehigh and Lackawanna Ice Company, the Gouldsboro Ice Company, the Saylersburg Ice Company and the W. L. Carr Mercantile Company of Gouldsboro. While active and busily engaged in professional labor and in his official business relations with corporate interests, Mr. Wells also is active in church and fraternity. He is a member of Green Ridge Presbyterian Church, which he serves as elder and clerk of session and for thirteen years was superintendent of the Sunday school, having previous to his going to Green Ridge been superintendent of the Sunday school of another church. He is a member of Peter Williamson Lodge, Free and Accepted Masons, and for twenty-five years has been district deputy grand master of the Thirteenth District of the State of Pennsylvania. He is also a companion of Lackawanna Chapter, Royal

Arch Masons, and a Sir Knight of Melita Commandery, Knights Templar. He is a member of the Country Club.

Mr. Wells married E. Louise Jenkins, born in Crompton, Wayne county, Pennsylvania, daughter of William and Mary (Sherman) Jenkins, the latter a connection of the General Sherman family; children: Anna, married Frank L. Phillips, of New York; Harold Sherman, now a resident of Portland, Oregon.

---

#### HERMAN C. RUTHERFORD

Of Scotch ancestry on his paternal side, born in New York state where he obtained his professional education, Mr. Rutherford has since 1894 been a resident of Scranton, where he is rated one of the leading architects of the city. He is a son of Robert Rutherford, and a grandson of George Rutherford, both born in Scotland, and the latter coming to the United States with his brothers, Walker, Robert and John; sisters, Janet and Isabel, and his own wife and children. The family settled in New York state soon after their arrival in 1853 and there George Rutherford died. His children: Robert W., William, Archibald, Agnes, Mary, all deceased.

Robert W. Rutherford was born in Scotland in the year 1838 and when a lad of fourteen years came with his parents, uncles and aunts to the United States. After some time spent in different locations they settled in Edmeston, Otsego county, New York. Robert W. went away to learn the machinist's trade and followed it many years, but owing to poor health was compelled to give it up, and moved back to Edmeston, where he died in 1881. He married Caroline, the youngest daughter of the Rev. Mr. and Mrs. Cyrus Steere, of Norwich, New York, who came with the early settlers of that county from the state of Rhode Island in the early part of the year 1800, and had the following children: Herbert G., Herman C., Nealon.

Herman C. Rutherford, second son of Robert W. and Caroline (Steere) Rutherford, was born at Edmeston, Otsego county, New York, October 10, 1872. He obtained his education in the primary, grammar and high schools, and later took up the study of architecture, and has since followed that profession, opening an office for himself in Scranton in 1898. During the past fifteen years of active professional and business life in Scranton he has become well and favorably known in the city as a man of ability, integrity and sound judgment, these qualities attracting a patronage most satisfactory. He is a director of the Williams Drop Forging Company, the Spencer Heater Company, the Scranton Real Estate Company, the Pine Brook Bank and many other industries in the city as well as outside. He is a member of Elm Park Methodist Episcopal Church, of Green Ridge Lodge, No. 597, F. and A. M., and is a thirty-second degree Mason, belonging to all of the bodies of Keystone Consistory, Ancient Accepted Scottish Rite, and to Irem Temple, the Mystic Shrine.

Mr. Rutherford married Nettie S. Davis and they have the following children: Robert W., born 1903; Catherine, born 1908.

---

#### MILTON W. LOWRY

Tradition, that elastic authority that while often misleading, sometimes preserves facts otherwise lost, weaves a dramatic story around John Lowry, the founder of the family now represented in Scranton by Milton W. Lowry, of the Lackawanna bar. John Lowry came from Ireland to Lowell, Massachusetts, and according to tradition was the son of a nobleman and induced to

make the trip across the Atlantic by an uncle named Lowell, after whom Lowell was named. The vessel on which he sailed was shipwrecked and young Lowry lost all the papers and documents that could have proven his identity, only escaping from the wreck with his life and a belt around his waist in which was a quantity of gold coins. He reached safety and continued his journey to Lowell, where later he married Sabra Hunt and reared a large family.

(I) One of the descendants of the emigrant, George Lowry, with his wife, Mary, moved to Sparta, New Jersey, prior to the year 1800 and there conducted his trade of cooper for several years. In 1806 he continued westward to Luzerne county, Pennsylvania, and later settled in Clifford township Susquehanna county. There he bought land, but later by reason of defective titles he lost it all. Mary Lowry lived many years after the death of George, her husband, later having married a Mr. Wilcox. She died in 1870, aged nearly one hundred years. George and Mary Lowry had children: Holloway, of further mention; Nancy, married Chauncey Deming; Polly, married Jeremiah Tuttle; John, removed to the West and settled in Kansas; Catherine, married P. S. Foster; George, unmarried; Sarah, married Orin Griswold.

(II) Holloway Lowry, eldest son of George and Mary Lowry, was born in Sparta, New Jersey, in 1801, died in Clifford township, Susquehanna county, Pennsylvania, in 1875. In 1822 he bought land in Clifford township but his title was also faulty and the money paid was lost. In 1823 he purchased a farm in Clifford township, upon which he resided until his death, also owning one on the southern slope of the South Knob of Elk Mountain. He was a prosperous farmer, very systematic and careful in his business affairs after his first bitter experience, and left an estate that was easily, quickly and cheaply settled by the executor, his son, James W. Lowry. He married, in 1824, Sophia Wells, of Clifford township. Children: Charles, born 1826, a farmer of Lackawanna county; Martha, born 1828, married Rev. G. M. Dimmick; James W., of further mention; John, born 1832, a farmer of Lackawanna county; Amy, born 1834, married J. F. Kenback; Sarah, born 1836, died 1863, married Elias E. Lowrie; Wright, born 1838, a farmer of Lackawanna county; Clark, born 1840, a merchant of Scranton; Benjamin, born 1842, a carpenter and builder of Luzerne county; Hezekiah, born 1844, a farmer on the homestead; Samantha, born 1847, married (first) Thomas Kelly, (second) John Philbin.

(III) James W. Lowry, second son of Holloway and Sophia (Wells) Lowry, was born in Clifford township, Susquehanna county, Pennsylvania, July 18, 1830, died December 3, 1908. He was educated in public schools, Dundaff and Waverly academies, and for seven years in early life taught in the public schools of Susquehanna and Wayne counties. In 1854 he married and purchased a farm near Elkdale on the east branch of Tunkhannock creek and there installed his bride. He conducted a lumber business with his father, built a saw mill on the farm and continued in business eight years. In 1862 he purchased a large farm and residence in Elkdale, to which he then removed and there conducted an agricultural implement business, engaged largely in the purchase and sale of farm stock and was interested in farming and bee culture. He enlisted with three of his brothers when Pennsylvania was threatened with invasion and with other volunteers went to Harrisburg to be sworn in, but the need for their service quickly passed by General Lee's retreat from Pennsylvania, and they returned home. Squire Lowry held the office of justice of the peace nearly forty years, was school director fifteen years, and in 1878 was the Republican candidate for the state legislature, failing of election by but twenty-eight votes. He was clerk and long time member of Elkdale Baptist Church, was active in church and Sunday school work, one of

the strong men of his community, and one of the original trustees of the Abington Baptist Association, of Lackawanna, Susquehanna, Wyoming and Wayne counties, which position he held from the incorporation of the association until his death.

He married, in 1854, Alma Taylor, born November 17, 1830, daughter of Thomas and Elizabeth (Worth) Taylor, her father, Thomas Taylor, born in Providence, Pennsylvania, in 1797, died 1892. Children: Wells J., a physician of Carbondale, Pennsylvania, married (first) Celia M. Fuller, (second) Flora M. Hammond; Milton W., of further mention; Samuel E.; Eva L., married to John E. Williams, of Ceres, California; Susan A. and George E., who died in childhood.

(IV) Milton W. Lowry, second son of "Squire" James W. and Alma (Taylor) Lowry, was born at Elkdale, Susquehanna county, Pennsylvania, March 10, 1859. He began his studies in the public schools, continuing at Keystone Academy, Factoryville, Pennsylvania, where all the children of Squire Lowry attended, and where his preparatory courses were finished. He then entered Pennsylvania State College, by appointment of Senator Nelson to a scholarship, made on competitive examination, whence he was graduated with honors, class of 1884. In his junior year he won the class oratorical prize, and in 1884, delivered the salutatory oration. Possessing the great requisite for a successful lawyer, the gift of graceful and forceful oratory and with his classical education meeting all requirements, Mr. Lowry, moreover, with an inherited love for the legal profession, decided to prepare himself for the bar. He began the study of law under the preceptorship of Hon. W. W. Watson, and in 1886 was admitted to the Lackawanna bar after successfully passing the required examinations. He began private practice at Scranton soon after having served as deputy prothonotary of Lackawanna county, which office he filled until April, 1888, when he resigned to devote his entire time to his law practice. He has risen to the front rank in his profession, and in contact with the strong men of the Lackawanna bar has so proved his fine natural gifts that no man may claim to be his superior in forcibly, clearly and eloquently presenting his case before judge, jury or tribunal. He has been admitted to all state and federal courts of the district and in all transacts a large amount of legal business.

Strong as is his position at the bar, Mr. Lowry is not less prominently or less favorably known in the public life of city, county and state. A Republican in politics, he has been active and influential in party councils, and as a campaign orator his eloquence and personal magnetism has strengthened the wavering and brought new recruits to the party standard. He was elected president of the Republican State League by the Altoona Convention in 1900 and served a term in that capacity. In 1904 he was appointed by the governor of Pennsylvania a trustee of Pennsylvania State College, his alma mater, and for upwards of ten years has, by reappointment, been associated with General James A. Beaver, Andrew Carnegie, M. E. Olmstead, Charles S. Schwab, Vance McCormick and other eminent Pennsylvanians and for a term of years has been a member of the executive committee of the board. Also for twenty years he has been a member of the board of trustees of Keystone Academy, Factoryville, Pennsylvania, where he prepared for college, an institution for which he has a most tender regard. In city affairs he has for years been a leading figure. He was a member of select council for several years, and during the administration of Mayor Dimmick served as president of that body. For many years he has been a member of Scranton Board of Trade, also member of the Committee on Municipal Affairs, and was appointed with Judge Kelly who together acted as attorneys for the Board of Trade to





*Major John B. Fish*



write an opinion and later to draft a series of ordinances to regulate the operations of the coal companies mining beneath the city of Scranton. Mr. Lowry is a member of the county and state bar association and many other bodies of varied purpose and in all is held in high esteem. He meets every issue in law, politics or in general debate fairly and squarely, uses no subterfuge to gain his ends, but by a thorough knowledge of his cause and forceful and eloquent presentation depends for victory.

Mr. Lowry married, in October, 1885, Annie Lowry, of English birth and parentage, and a graduate of Bucknell University, in 1883. Since 1884 his residence has been in Scranton, his present home being at 601 Clay avenue, corner of Olive street, a beautiful residential section. He has one son, Robert, a graduate of Princeton University, class of 1912. Mr. Lowry is a member of the Immanuel Baptist Church of Scranton, and one of the official board and is president of the board of trustees. In 1910 he was elected as a trustee of the Abington Baptist Association to fill the vacancy caused by the decease of his father.

---

### MAJOR JOHN BILLINGS FISH

Major John Billings Fish was a fine type of that character which has contributed in such large degree to the development of the resources of Pennsylvania, and to the extension of its splendid industrial enterprises. While thus acting as a prime factor in the accomplishment of great results, which have largely benefitted the entire community, he also accumulated considerable personal interests as the reward of his intelligent and industrious effort, preserving throughout his entire career a spotless character. He came of an old family, distinguished for active and clean lives, and he inherited in rich measure the patriotic spirit which animated his forebears, and was among the first to respond to his country's call when there was need for his service on the field of battle.

Edmond Fish, grandfather of Major John Billings Fish, was an active participant in the struggles of the Continental army during the war of the Revolution, and was one of the most patriotic of the brave men of those days. Daniel Fish, father of Major John Billings Fish, was born in Connecticut, and died at the age of ninety-two years in Damascus, Wayne county, Pennsylvania. He was a soldier in the War of 1812.

Major John Billings Fish was born at Liberty, Sullivan county, New York, March 14, 1829, died at Scranton, Pennsylvania, July 15, 1905. He was educated in the public schools of his native town, and upon the completion of his studies he was apprenticed to learn the trade of tinning and sheet iron working, being in the employ of others until he had almost attained his majority. He then established himself in this line of business independently at Liberty, but not long afterward removed his business to Hancock, Delaware county, New York, where he continued for about one year, then sold his business and removed to Bainbridge, New York, worked there at his trade as a journeyman for about two years, then spent one year in Deposit, New York. In 1854 he removed to Pittston, Pennsylvania, where he served as burgess in 1858 and 1859.

In 1861, when President Lincoln issued his call for three months' men, Major Fish was one of the first to volunteer his services, and enlisted in the Eleventh Regiment Maine Volunteer Infantry. He was advanced to the rank of lieutenant, was with the first troops to cross the Potomac above Washington, and his was the first Maine company to have blood spilled during the war. He re-enlisted at the close of his first term of service, becoming first lieutenant

in the Fifty-second Regiment Pennsylvania Volunteer Infantry, and his men were the first to drive the Confederate forces from Chickahominy. At that point he had his first meeting with General Negley, and thereafter was in his command as a scout and on reconnoitering duty. In 1863 he was promoted to the rank of captain at Morris Island. He was mustered out, January 27, 1865. His service was varied and distinguished throughout for fidelity and bravery, taking part in the occupation of Martinsburg, siege of Yorktown, Lee's Mills, Williamsburg, Seven Pines, seven days before Richmond and Malvern Hill. He sailed for Beaufort, South Carolina, December 31, 1862, taking part in the assault on Fort Johnson, action at Secessionville, bombardment of Fort Sumter, having charge of three guns, also of picket boats in Charleston Harbor; capture of Fort Clegg, in command of Mortar and Columbian Battery on Morris Island, and was complimented highly by the commanding general.

At the close of the war Major Fish took up his residence in Providence, Scranton, which was the seat of his business activity from that time until his death. In association with Sheriff Lewis he engaged in the hardware business in 1866, but sold his interest in this in 1868. He accepted a position as superintendent of the Providence Gas and Water Company, an office he filled many years. He was the leading spirit in the organization of the North Scranton Bank, of which he served as a director many years, and was personally interested in a number of other important business enterprises. He was a man of superior business ability, and his rank in the business world was a more than ordinarily high one.

In military matters his executive ability was no less pronounced, and he served five years as captain of Company H, Thirteenth Regiment National Guard of Pennsylvania, being elected captain, October 20, 1885; major, October 4, 1888, and was in active duty with this rank four years. In political affairs Major Fish was an active and consistent supporter of the Republican party, and while his labors in the field of politics were of great benefit to the community, he never held nor desired to hold a salaried public office. His fraternal affiliation was as follows: Military Order of the Loyal Legion of the United States, to which he was elected May 6, 1896, Class I, Insignia 11448; a charter member, and a member of the board of control of Lieutenant Ezra Griffin Post, No. 139, G. A. R., of Scranton; Susquehanna Lodge, Free and Accepted Masons, of Bainbridge; Celestial Lodge, Independent Order of Odd Fellows, of which he was the first noble grand. He served as an elder of the Presbyterian church, of Providence, and was a liberal contributor to the support of this institution.

Major Fish married, October 5, 1853, Sarah A., a daughter of Robert and Laura Turner, of Bainbridge, New York, whose ancestors also took part in the Revolutionary War. Children: Laura T.; James B., married Edith Arnold and has one son Robert; Morris P., deceased. Mrs. Fish, who was born in Deposit, New York, passed to her eternal rest some months before her husband, her death being hastened by the shock due to a fall experienced at her own home, some weeks previously. She left behind her a record of good deeds and loving kindness, which will be long remembered. Major and Mrs. Fish had the rare pleasure of celebrating their golden wedding anniversary, and this occasion was one which will not be soon forgotten.

We cannot better show the high esteem in which Major Fish was held than by giving an extract from an article which appeared in the principal newspaper of Scranton at the time of his death.

His purity of inner life, his fervent love for the Word of God, his loyalty to Zion, his Christian liberality and stanch type of practical purity, form a rich legacy to the

church in which he was esteemed and loved.—Major Fish was a good man. He was a Christian man and never uttered a harmful word about his fellow man. He died as he had lived, with a faith in the true Christian's hope for the future. He was a true friend to those with whom he was mostly intimate. The writer knows whereof he speaks. For over a quarter of a century he was an adviser, a patron, a friend in time of need, and we shall miss his kind counsel. But he is gone to a rest well earned.

The following resolutions were adopted by the directors of the North Scranton Bank:

For many years a resident of North Scranton, we well knew the life he led. To this community it was a benediction, and to all his neighbors an inspiration; high-minded, strong and courageous in his convictions, from a proper sense of duty, he never wavered. Bright and cheerful in disposition, his presence on any occasion was grateful, his absence invariably deplored. From the organization of The North Scranton Bank until the hour of his untimely death he was the promoter and father of the institution, always taking deep interest in its success and ever ready to promote its welfare. A member of our board of directors, he was sagacious and conservative in consultation, no detail of its business escaped his notice, nor did any matter appear too trifling to claim his attention. And now, finally, may it be said that he was a man of many friends and no enemies.—P. J. Ruane, J. A. LaBarr, J. R. Atherton, Committee.

---

### ROBERT JOSIAH BAUER

Of the fourth American generation of his family, Professor Bauer, the well known band master and musical director of Scranton, traces his ancestry to Abraham Bauer, who came with his family from Germany, settling in Pennsylvania. He served as a captain in the Revolutionary War and later made settlement at Wind Gap, now a borough of Northampton county, Pennsylvania, near the Killany Mountain, thirteen miles from Easton on the New Jersey Central and other railroads. He had sons, Charles, Jacob, Abraham, Samuel, Adam, Reuben. From these spring all the different branches of the Bauers claiming descent from the brave old Revolutionary soldier and pioneer settler.

(II) Charles Bauer, son of Abraham Bauer, "the settler," became a school teacher in early life at Wind Gap, later engaging in other occupations more profitable in that day. He married Mary Wever, of Plainfield, New Jersey, and had issue: Abraham, William, Frank, Kate, Emma, Josiah.

(III) Josiah Bauer, son of Charles Bauer, was born at Wind Gap, Pennsylvania, in 1829. He became a large and wealthy contractor, owning considerable property which he lost during the war between the states. In 1869 he came to Scranton, where for \$300 he was offered a large tract of land, now valuable, but then so swampy that he failed to see its future value. He conducted business in painting and contracting until his death in 1876. He was possessed of marked musical ability, a talent that he transmitted to his son. He married Lucy, daughter of Frederick Warner, and had issue: Augusta, married Bromley Williams, of Scranton; Robert Josiah, of further mention; Rev. Benjamin, Minnie, Ellen, Emma, Amanda, all deceased except the two first named.

(IV) Professor Robert Josiah Bauer, son of Josiah Bauer, was born at Nazareth, Pennsylvania, April 17, 1857. He attended the public schools, and in 1869 came with his parents to Scranton. He displayed a decided musical talent from his youth and was taught by his father until the death of the latter in 1876. The young man then spent a year in New York City under a noted violin instructor, returning to Scranton in 1877. He was then not only an accomplished performer but a capable leader, and having decided upon a musical career he organized "Bauer's Military Band and Orchestra," an organization he has successfully conducted for thirty-five years. The band and orchestra

has ever been one of the leading musical organizations and its leader one of the noted conductors of northeastern Pennsylvania. He has developed a perfect musical organization and from its ranks many noted performers have been graduated. The band at present numbers forty musicians, perfectly trained, held under perfect control by the baton of their talented leader, who carries them through the difficult scores with a skill that perfectly interprets the theme of the composer. Professor Bauer is not alone an artist and conductor, but is also a composer of band and orchestral music, many of his compositions having brought him fame in that field. He is a musical authority in the city and has achieved a fame that extends far beyond local limits. He is a member of Scranton's well known musical organizations, the Leiderkrantz and Junger Mannerchor; belongs to Peter Williamson Lodge, Free and Accepted Masons; Lackawanna Chapter, Royal Arch Masons, Coeur de Lion Commandery, Knights Templar; Irem Temple, Ancient Arabic Order Nobles of the Mystic Shrine; Benevolent and Protective Order of Elks and the Temple Club. In political faith he is a Republican.

Professor Bauer married Mary, daughter of Thomas Leysen, and has children: Allen, a surveyor; Theodore, a musician; Helen; Florence, deceased, Julian, deceased.

---

#### GEORGE W. MAXEY

The Welsh founders of the city of Carbondale number among them several of the name of Maxey and Evans, both the paternal and maternal ancestors of George W. Maxey, they having come nearly a century ago from Wales to Lackawanna county, Pennsylvania, where many of the family still reside. Benjamin Maxey, father of George W. Maxey, is at the present time mine inspector of the twenty-first inspection district, comprising the counties of Susquehanna, Wayne and Sullivan. He is the son of George and Mary Daniels Maxey. George W. Maxey's mother, now deceased, was Margaret (Evans) Maxey, the daughter of Lewis and Ann Evans.

George W. Maxey was born in Forest City, Pennsylvania, February 14, 1878. He was a student in the public schools of his native town. He also worked as a miner and in other capacities in the mines of Vandling near Forest City. He prepared for college at the Mansfield State Normal School. In 1898 he entered the University of Michigan, where he graduated with the degree of A. B., in the year 1902. While a student at the University of Michigan, Mr. Maxey was interested in debating and oratory, winning first prizes in several contests and representing the University of Michigan in several inter-collegiate debates with teams from the Universities of Chicago and Minnesota and the Northwestern, his university winning the championship of the Central Debating League. Mr. Maxey held among other important elective positions at the University the position of managing editor of the University of Michigan Daily News. The year following his graduation at Michigan, Mr. Maxey entered the law department of the University of Pennsylvania, completing the prescribed course in less than three years. In this college also he was prominent in debating circles and won the first prize in debating. He twice led the University team in debates with the University of Virginia, in both of which his team was successful. He was also elected president of his class in this institution.

He was admitted to the bar of Lackawanna county, March 12, 1906, and has since been active in the practice of law in this county and has frequently appeared in court at Montrose, the county seat of Susquehanna, his native county. Soon after his admission to the bar he formed a partnership



George W. Wasey.



with Edwin C. Amerman, the offices of the firm being in the Republican Building. On September 16, 1913, Mr. Maxey was nominated both by the Republican and Washington parties for the office of district attorney, his majority in both parties at the primaries being about twenty-five hundred votes. On the 4th of the following November he was elected district attorney by a plurality of thirty-eight hundred and sixty-five votes over his Democratic opponent. He entered upon the duties of his office, January 5, 1914. That no influence can be brought to bear upon Mr. Maxey to cause him to deviate from a path of the strictest rectitude is well known to all acquainted with his professional career, and to those who are privileged to be his friends in private life he is known for his loyalty and fair dealing. He has made an auspicious beginning upon a career of promise and he has the natural talents and habits of industry that insure his continued success.

---

### JOHN WESLEY PINNELL

The Pinnell family was founded in the United States by the immigration of two brothers, Robert and Charles, both natives of England, and the only members of their line who left the home land. Robert Pinnell was born February 22, 1817, and was reared to manhood and educated in England, coming to this country in 1848. Both he and his brother settled in New York state, he making his home in Bovina, Delaware county, New York, where he was joined by his wife 1849. He was a blacksmith by trade and was proprietor of a shop in Delaware county for fifteen years, a part of that time being associated with John Johnson. In 1864 he moved to Dunmore, Pennsylvania, and was employed in the machine shops of the Pennsylvania Coal Company until his retirement, his death occurring in Dunmore in 1882, his wife also dying in that place. He married, in 1845, Mary Hyam, born in England, September 25, 1822, and had children: Elizabeth, deceased; Jones T., of whom further; John Wesley, of whom further.

(II) Jones T. Pinnell, son of Robert and Mary (Hyam) Pinnell, was born in Bovina, Delaware county, New York, May 6, 1850. He obtained his education in the public schools of that place and in the Dunmore High School, to which latter place the family home was changed in 1864. He served a five years' apprenticeship in the moulder's trade in the foundry of the Pennsylvania Coal Company, his instructor being John Deacon, one of the most skillful and adept masters of his trade in that locality. He was successively employed in the Dickson Works, Delaware, Lackawanna & Western Railroad, the Lackawanna Iron and Steel Company, then returning to the service of the Pennsylvania Coal Company. His independent start in business was on a modest scale, but industry and ceaseless application had made him the proprietor of a firmly established and paying business, his iron and brass foundry, a well equipped plant forty-five by forty feet, housing a thriving concern. Mr. Pinnell has attracted a large trade by the excellence of his work along special lines and performs all kinds of jobbing and mine work. Soon after its invention in 1887 he placed on the market Pinnell's Sash Weight, one of the most efficient devices of its kind manufactured, which met with a welcome reception from builders and householders. His first invention was a belt tightener, and among many other useful articles he devised a can top straightener, made of aluminum, an indispensable adjunct of the fruit jars in common use among housekeepers, the best of his inventions all covered by patents. Mr. Pinnell is a supporter of the Republican party, and holds membership in the American Mechanics.

Mr. Pinnell married (first) in Dunmore, Pennsylvania, Clara Bailey, born

in Waymart, Pennsylvania, died in Dunmore, Pennsylvania, June 1, 1888, daughter of William Bailey, former principal of the Green Ridge School. Children: 1. Lizzie, married a Mr. Oliver, of Dunmore, Pennsylvania. 2. Edward, a moulder, associated in business with his uncle, J. W. Pinnell. 3. Wesley, a machinist in the employ of the Finch Manufacturing Company. 4. Howard, foreman for his uncle, J. W. Pinnell. 5. Nettie, wife of Henry Zeigler, superintendent of Clotts Silk Mills, Alexandria, Virginia. Mr. and Mrs. Pinnell were also the parents of a daughter Clara, who died in infancy. He married (second) November 24, 1898, Arbelle Barton, only daughter of David and Metahtable (Krotzer) Barton, of Washington, D. C., died at Dunmore, Pennsylvania. Her parents had two sons. No children to second marriage.

(11) John Wesley Pinnell, son of Robert and Mary (Hyam) Pinnell, was born at Bovina, Delaware county, New York, July 11, 1852. He obtained his scholastic training in the schools of New York state and of Dunmore, Pennsylvania. His connection with manufacturing began in 1881, and he still continues in that line. His first venture was in partnership with Edward Gibson, the two establishing in the foundry business on First street, Jersey City, New Jersey, Mr. Pinnell selling his interest the following year and returning to Dunmore. Here he entered the same line in conjunction with his brother, Jones T., the firm transacting business as Pinnell Brothers, Jones T. Pinnell becoming sole proprietor when his brother entered hardware dealing in 1885. This line Mr. Pinnell abandoned in 1894, re-entering the foundry business and continuing until the purchase of his plant by the Scranton Steam Pump Company in 1901, being employed by this concern as foundry superintendent for the two following years. In 1903 he once more became independently engaged in foundry work, his place of business being on Green Ridge street, where he remained until 1906, when he purchased his present plant at No. 1200-1208 Capouse avenue. In this place Mr. Pinnell conducts an extensive and lucrative business, his wide experience in and extensive relations with foundry work giving him a firm basis upon which to found the prosperity of his plant. This is his only business interest, and he is a stockholder in the Anthracite Bank of Scranton. He is a member of the Methodist Episcopal Church of Dunmore and has been a member of the choir of that church for forty-six years, first singing as a member thereof in 1868, and still singing there (1914). His fraternal orders are the Knights of Pythias, in which he has been treasurer of trustees, outer guard, inner guard, master at arms, vice-chancellor, chancellor commander, past chancellor, prelate; the Knights of Malta, and has filled all the chairs, having been senior warden, captain general, generalissimo, sir knight commander, and prelate; and the Improved Order of Heptasophs.

Mr. Pinnell married, in Dunmore, Pennsylvania, September 21, 1876, Junia Frances Dilley, born in Dunmore, Pennsylvania, April 27, 1856, daughter of Stewart Dilley, born at Hanover, Pennsylvania, January 23, 1829, and Lucinda (Wert) Dilley, born near Reading, Pennsylvania, June 5, 1833. Stewart Dilley was superintendent of the Pennsylvania blacksmith shops at Dunmore, Pennsylvania, from 1854 until his accidental death in 1869. Children of Mr. and Mrs. Dilley: Junia Frances, above mentioned; Mary, married E. W. Bishop; Lydia, deceased; Ruth, married S. M. Ives, of Taylor, Pennsylvania; S. G., deceased. John Wesley and Junia Frances (Dilley) Pinnell are the parents of: 1. Lydia Mae, born in Jersey City, New Jersey, November 29, 1880; married a Mr. Shaffer, and has one daughter, Ruth, born in Dunmore, Pennsylvania, February 16, 1902. 2. Hope Junia, born in Dunmore, Pennsylvania, November 5, 1884; married Stewart B. Seigle. 3.



Lucinda, born in Dunmore, Pennsylvania, March 19, 1892. It is curious to note that the birth dates of Mr. Pinnell, his wife and children, as well as the date of marriage of the parents, fall in a bissextile or leap year, a coincidence seldom occurring

---

#### OOSEE D. DEWITT

The lines of business in which Osee D. DeWitt is known to the city of Scranton are lumber, planing mill, insurance, real estate, and automobiles. In the eighteen years covering the time Mr. DeWitt has been in Scranton he has become well and favorably known in the city of his adoption. He is a son of Isaac DeWitt, born in New Jersey, a shoemaker by trade. Isaac DeWitt enlisted in the Union army in 1862 and fought in the ranks until the close of the war, in one battle receiving a severe wound in the hand. Upon the signing of articles of peace he was given an honorable discharge, but the wound in his hand had incapacitated him for delicate work, so that he was compelled to abandon his trade. He engaged in farming operations and lumber dealing until his death, holding membership in the Grand Army of the Republic. He married Lucy Spencer, of Wyoming county, Pennsylvania, and had: Eva, deceased; G. Dow; Osee D., of whom further; Warren Spencer, president of the DeWitt Lumber Company; Martha; Walter, met an accidental death by drowning.

Osee D. DeWitt, son of Isaac and Lucy (Spencer) DeWitt, was born in Rockford City, Illinois, June 9, 1858. His parents moving to Susquehanna county, Pennsylvania, when he was a child, he was there educated in the public schools. In later life he engaged in lumber dealing, managing the lumber mill of DeWitt Brothers in Wyoming county, and in 1896 moved to Scranton, there engaging in the same business until 1907. In that year he sold his interests in the firm and established in insurance and real estate dealing at Green Ridge, later moving his office to the Miller Building, Scranton. When he first came to Scranton he became associated with his brother, W. S. DeWitt, in a retail lumber and planing mill business in which he continued until 1906. The partnership being dissolved at that time he entered into the real estate and insurance line alone; later in 1912 became interested in the automobile business and organized the Eureka Motor Car Company, later becoming manager. In 1912 he located at No. 319 Washington avenue, there adding automobile activity to his earlier lines, being president and manager of the Eureka Motor Car Company. He holds the agency for the Franklin car and the Brockway truck, both machines with many desirable features, both meeting other cars and trucks upon a level of efficiency, in the one elegance and comfort in construction, in the other, strength and durability. Mr. DeWitt's only other business connection is as vice-president of the Green Ridge Bank. His fraternal society is the Independent Order of Odd Fellows, in which he belongs to the Green Ridge Lodge, and he is a member of the Methodist Episcopal church, holding a place upon the board of trustees.

He married, October 26, 1881, Priscilla A., daughter of Mark A. and Priscilla Gardner, of Wyoming county, Pennsylvania. Mr. and Mrs. DeWitt are the parents of: Harry G., born July 4, 1886, and Hazel P., born August 14, 1896.

---

#### JUSTIN ELISHA PARRISH

A descendant of the Connecticut Parrish family, and of Archibald Parrish, who settled in the Wyoming Valley shortly after the "Massacre," Justin

E. Parrish possesses an ancestry that in both states helped to lay the foundation for future greatness. On the site of the present Courthouse Square in Wilkes-Barre, Pennsylvania, once stood one of the old taverns or inns of the early day. This tavern was kept by Archibald Parrish, and after his death by his widow, Phoebe (Miller) Parrish, who died at the great age of ninety-eight years. Archibald and Phoebe Parrish had issue: Bradley, served in the Union army during the war between the states; Archibald, one of the organizers of the Adams Express Company; Gould, built the first powder mill in northeastern Pennsylvania; Charles, organized the Wilkes-Barre and Lehigh Coal Company, and was one of the leading coal operators of his day; Sarah, married Frank Hunt and had issue, Charles P., Elwood, Anna; Mary G.; George H.

George H. Parrish was born at Wilkes-Barre, Pennsylvania, in 1823, there grew to manhood, learning and following the trade of blacksmith. He afterward moved to Louisville, Kentucky, there opening and conducting a shop devoted to his trade. After the destruction of his plant by fire, he moved to Beaver Dam, Wisconsin. In 1864 he returned to Wilkes-Barre where he became associated with his brother, Charles, in coal mine operations. The latter had recently opened the Dundee Shaft at Buttonwood near Wilkes-Barre, now owned by the Delaware, Lackawanna & Western Coal Company. Charles Parrish had in 1864, in association with Samuel Thomas, established the firm of Parrish & Thomas and operated what is now known as Breaker No. 9 of the Lehigh & Wilkes-Barre Coal Company, at Sugar Notch, near Wilkes-Barre, then an undeveloped coal property. There were several changes of ownership and firms in the early operations, Parrish & Drake becoming owners of Breaker No. 9, and mines at Pine Ridge and the mine then operated by Thomas Broderick, now known as the Empire Mine, these properties forming the nucleus of the present Lehigh & Wilkes-Barre Coal Company, organized by Charles Parrish and now one of the strong coal companies of the anthracite region. George H. Parrish was interested with his brother in the business until his death.

Mr. Parrish married Charlotte Matilda Brown, of New Jersey, their wedding journey being taken in one of the coaches of the old Wilkes-Barre and Easton stage line. They were the parents of fourteen children, five of whom are yet living: Justin Elisha, of whom further; Ernest L., Harry E. dsal, Nellie B., Esther N.

Justin Elisha Parrish was born at Louisville, Kentucky, November 23, 1854, residing in boyhood in that city, Beaver Dam, Wisconsin, and coming with his parents to Wilkes-Barre, Pennsylvania, in 1864. He was educated in public schools and Lawrenceville Preparatory School, beginning active business life in 1874 when he entered the Wilkes-Barre branch shops of the Dickson Manufacturing Company of Scranton. He began work in the machine shop and after a time went to the draughting room and was in that room two years, then was transferred to the same department at the works in Scranton. While there he assisted in preparing the designs and later in the erection of the five blowing engines installed by the Lackawanna Iron and Coal Company, then an innovation in coal mining. In 1880 he was transferred to the Wilkes-Barre shops, but in a much different and higher capacity. The superintendent of the works, James E. Dickson, having resigned on account of ill health, Mr. Parrish, who had made such progress in his mastery of the business, succeeded him. He continued as superintendent for five years, then resigned in order to avail himself of expert instruction in the application of electricity to machinery, and for illuminating purposes, this agent then just coming into use. He spent several months in New York City with the Arnoux & Hochhausen

Company, gaining the desired information concerning electrical machinery and installation. Returning to Wilkes-Barre he was appointed superintendent of the Wilkes-Barre Electric Light Company, organized by his father, George H. Parrish, four years earlier. The company at this time was operating seven, ten arc light dynamos for street illumination, the cost to the city being seventy-five cents nightly. In 1886-87 Justin E. Parrish constructed and operated the incandescent lighting system for the entire city. At the same time W. B. Rockwell had organized a company in Scranton under the name of the Illuminating Heat and Power Company located on Lackawanna avenue at the foot of Linden street. In 1888 Mr. Parrish came to Scranton succeeding Mr. Rockwell as superintendent of the company just mentioned. The company at that time had a plant of sufficient power to operate two thousand incandescent and thirty arc lights, but so popular did the new light become that when later the company sold out to the Electric Company of America it was operating thirty thousand incandescent lights, one thousand arc lights and generating two thousand horse power for motor service. At the same time Mr. Parrish came to Scranton (1888) E. B. Sturgess installed and was operating the first electric street car system used in the United States, his power plant being on Washington avenue. He later sold to the Scranton Railroad Company but retained his power plant changing his generators and machinery, making them effective for electric lighting purposes. Mr. Parrish, as superintendent, was called unexpectedly to face a great emergency, when on January 1, 1897, the company's lighting plant was destroyed by fire. This would have left the city without light but Mr. Parrish had power and light brought from the Street Car Company, the Suburban Light Company and the Electric Light Plant of the Dickson Manufacturing Company. At the end of seventy-two hours he had an efficient lighting plant built and in operation on the ruins of the old one, installing eight dynamos and four engines for incandescent lighting and one for arc lighting. When a few years later the Electric Company of America purchased the Dunmore and the Suburban Electric Light Companies, the Illuminating Power and Heat Company and Scranton Electric Light and Power Company, Mr. Parrish remained with the new company under the consolidation, but later decided to engage in business privately. He did so for the ensuing two years, but was then induced in addition to his own business, to return to the company as superintendent of their entire system. He remained as such two years, when the American Gas and Electric Company of New York City, Henry L. Doherty, president, purchased the system. Mr. Parrish then returned to private business and so continues, one of the leading electrical and mechanical engineers of his state.

Mr. Parrish is held in high esteem by his brethren of the Engineers Association of Northeastern Pennsylvania, and in the various Masonic bodies with which he is affiliated, having a wide circle of business and social acquaintances outside the bodies named. The fraternal orders which he is connected with are: Peter Williamson Lodge, Free and Accepted Masons; Lackawanna Chapter, Royal Arch Masons; Coeur de Lion Commandery, Knights Templar; Irem Temple, Nobles of the Mystic Shrine; Keystone Consistory, Ancient Accepted Scottish Rite, thirty-second degree; Independent Order of Heptasophs and Royal Arcanum. He is an independent in politics, and a member of the Second Presbyterian Church.

Mr. Parrish married Elizabeth, daughter of Washington La Grand, of Wilkes-Barre, Pennsylvania, the latter a blacksmith, and his brother, Louis, a carriage maker of Wilkes-Barre. In 1865 Washington La Grand moved to Sugar Notch, there taking charge of the smithing department and machine shops of Parrish & Thomas. When Mr. Parrish returned to Wilkes-Barre,

Mr. La Grand accompanied him, becoming manager of the Empire shops. He died in May, 1913, aged eighty-four years. Children of Justin E. and Elizabeth (La Grand) Parrish: Helen J., married E. H. Clark, of Scranton; Justin Elisha (2), now of Montreal, Canada; Charlotte B., a graduate of Wellesley College; La Grand, now a student at Lawrenceville Preparatory School, Lawrenceville, New Jersey, an institution from which his father graduated in 1874, and has the same room his father had.

---

#### EDWARD LATON FULLER

The late Edward Laton Fuller, of Scranton, Pennsylvania, was a man whose death was deeply and sincerely deplored by all classes of society. It was not alone that he accomplished great things for the business world of Scranton that made him a noted personality, but his large heart, his liberal ideas on all subjects, endeared him to all with whom he came in contact. The fine traits which characterized him were inherited from an honorable ancestry which can be readily traced to the Pilgrims of 1620.

(I) Dr. Edward Fuller, the direct ancestor of Edward Laton Fuller, came to this country on the "Mayflower," in 1620, and landed at Plymouth with his wife and son Samuel. Dr. Fuller and his wife could not long endure the hardships the early settlers in this country were called upon to contend with, but their son grew to manhood, married, and his descendants have added prestige to the family name. We find the second and third generations in Connecticut, from whence they migrated to Montrose, Pennsylvania, when that section of the country was still a wilderness. Edward, great-grandfather of Edward Laton Fuller, married Hannah West, who was interred in the cemetery in Scranton. They had children: Charles, Edward, Henry, Isaac, George, Mary L., Elizabeth, Deborah.

(II) Charles Fuller, son of Edward and Hannah (West) Fuller, was born in New London, Connecticut, November 1, 1797, died November 29, 1881. The family removed to Bridgewater township, Luzerne county (now Susquehanna county), Pennsylvania, in 1806, and in this section, which boasted of but few settlers, the opportunities for acquiring an education were very limited. At the age of thirteen years he sought and found employment in a country store at Tunkhannock, and subsequently held a similar position in Kingston. In 1817 he established himself as the proprietor of a drug store in Wilkes-Barre, and when he sold this business turned his attention to farming, his products being taken by team over the Pocono to Easton, then the only market for the Wyoming Valley. In 1848 he took up his residence in Scranton, where he became bookkeeper for Scranton & Platt, and later for the Lackawanna Iron and Coal Company, with whom he remained some years. Still later he devoted his energies and fine business ability to the insurance business, in which he was very successful. October 14, 1848, he was one of the organizers of the Presbyterian church of Scranton, and the scope of the work he thus created can scarcely be overestimated. Mr. Fuller married, January 8, 1818, Maria Scoville, of Exeter township, Luzerne county, Pennsylvania, who had been born in Connecticut, in 1802, and their children were: James, Edward C., Laton S., John, Mary, Catherine, Penelope, Francis, Eudora.

(III) Edward C. Fuller, son of Charles and Maria (Scoville) Fuller, was born in Wyoming, Luzerne county, Pennsylvania, June 8, 1826, and received an excellent education in the Wyoming Seminary. He had learned the art of manufacturing rope under the able instruction of his father, and then traveled two years as salesman for the output of their factory. He then took up the study of pharmacy under the preceptorship of Dr. Throop, later becoming





*E. T. Tracy*

associated with him in the drug business, the partnership being dissolved in 1851. Mr. Fuller then opened a drug store in Hawley, Pennsylvania, conducted this one year, then removed to Scranton, which city was his place of residence from that time. Associated with him was his brother, and the drug business at No. 303 Lackawanna avenue was conducted under the style of L. S. and E. C. Fuller, until four years prior to the death of Mr. Fuller. His interest in the Republican party was an active one, and he became associated with it when Fremont was its first presidential candidate. He was elected school controller in 1860, held this office some years, and was honored with the office of treasurer of the school board during the greater part of this time. President Garfield appointed him postmaster of Scranton, May 16, 1881, and he was continued in office by President Arthur. He was elected city assessor in 1890, and served three years. When the Lackawanna Hospital was organized, Mr. Fuller was chosen for the responsible and honorable post of director and treasurer, an office he filled with ability until his death. He was also president of the Dunmore Cemetery Association from the time of its organization until his death. In early manhood he became one of the charter members of the First Presbyterian Church. Mr. Fuller married Helen Ruthven, who died in October, 1892, and they were the parents of: Charles R., who married (first) Frances Penman, (second) Catharine Scranton; Edward Laton, whose name heads this sketch; James A., married Eva Davis; Harry G., married Ida Frink, and died in November, 1893.

(IV) Edward Laton Fuller, son of Edward C. and Helen (Ruthven) Fuller, was born at Hawley, Pennsylvania, October 10, 1851, died suddenly at Augusta, Georgia, whither he had gone to recuperate, January 29, 1909. The public schools of Scranton furnished him with educational advantages, which he utilized to the utmost. Throughout his life he was earnest and thorough in whatever he undertook. Having accumulated a sufficient capital, he invested it in the purchase of coal lands, operated these to advantage, sold them and with the money thus obtained made larger purchases, and continuing along these lines for some years, he finally came to be regarded as one of the largest individual coal operators in the anthracite section. At various times he owned the Mount Pleasant Colliery, at Scranton; the Seneca Coal Company's properties, the Newton Coal Mining Company, the old Forge Coal Mining Company, at Pittsburgh and the Girard Coal Company, at Mount Carmel, Pennsylvania. He was the organizer of the Fuller Syndicate, and by means of his influence as a director in the Western Maryland Railroad Company and the West Virginia Central and Pittsburgh Railroad Companies, secured control of these corporations. His connection, official and otherwise, with a number of other important enterprises is partially as follows: President of the Empire Limestone Company, of Buffalo; the Retsof Mining Company, of New York; the Avery Rock Salt Mining Company, of Louisiana; and the Genesee and Wyoming Railroad Company. He was a director in the Penn Casualty Company and the Wyoming Shovel Works. But his principal interests were connected with the salt industry, and as president of the International Salt Company he was a dominant factor. His efforts in other directions have been of lasting benefit to the city, and his influence will be felt for generations to come. It was through his instrumentality that the Erie Railroad Company purchased the Pennsylvania Coal Company and the Wyoming Valley Railroad, and obtained important and favorable contracts for the individual operators for the sale of their coal. This was one of the great changes in the coal industry.

Mr. Fuller ever had the welfare of the city deeply at heart, and was fore-

most in furthering all projects which could benefit it in any manner. He was the head of the Municipal League of Scranton, a member of the Scranton Board of Trade and of the Chamber of Commerce. The State Hospital at Scranton, formerly known as the Lackawanna Hospital, which had had the generous support of his family for generations, had the benefit of his active support, and he served as president of its executive committee and treasurer of its board of trustees. The cause of education also had in him a warm supporter and friend, and in connection with this work he gave much of his time and attention to the Young Men's Christian Association, making liberal donations, and serving as president of its board of trustees. He was also a director of the Pennsylvania Oral School for Deaf. He was for many years a member of the Second Presbyterian Church of Scranton, served as president of its board of trustees, and in commemoration of the celebration of his silver wedding he and his wife erected an addition to the church building. His membership in organizations of various kinds was a large one, a partial list being as follows: Society of American Engineers; Transportation Club, of New York; Union League Club, of New York; Lawyers' Club, of New York; City Midday Club, of New York; Scranton Club; Country Club of Scranton; New York Yacht Club; Maryland Club of Baltimore; Buffalo Club of Buffalo, New York; Westmoreland Club, of Wilkes-Barre; Atlantic Yacht Club; Economic Club; Pen Club; New England Society, of Scranton and New York.

Mr. Fuller married, in 1876, Helen M. Silkman, and they had one son: Mortimer Bartine, whose sketch follows. Mrs. Fuller, who died in August, 1912, was a daughter of Mr. and Mrs. Daniel Silkman, for many years residents on North Main avenue, Scranton, and a sister of Mrs. Byron Winton, who died a few years ago; Mrs. Charles Mercer, of Washington, District of Columbia; and Mrs. John Ryon, of Pottsville, Pennsylvania. The death of Mrs. Fuller was a sudden and unexpected one, and was probably hastened by the burning of the barn and stables at her magnificent country seat, "Overlook," three weeks previously, when a number of valuable pet horses lost their lives. She had apparently recovered from this shock, however, but it had evidently been too much for her sensitive and sympathetic nature, and she succumbed. Like her lamented husband, she was a woman of unbounded charity and nobility of character, and her benefactions, however liberal, were always bestowed in an unostentatious manner. The amount of them will never be known save by the immediate recipients. In the world of society she held a leading position, to which her grace, beauty and tact fully entitled her. Her personality was a most charming one. Simplicity of manner was combined with rare intelligence and a never-failing courtesy, which made her the center of her social circle. As a hostess her receptions were characterized by an originality it would be difficult to duplicate. In every respect she was a fitting and charming helpmate to her honored husband.

A review of the character of Mr. Fuller can be best given in a few extracts from editorials in the leading papers of Scranton at the time of his death. From the Scranton Times we glean the following:

Mr. Fuller was a very steam engine of effort. He had built up great enterprises. Having been with them from the start he knew every detail of the business and would not recognize the fact that they had grown to such enormous proportions that the work of looking after details was beyond the power of any one man. At home he worked many hours every day. When he traveled for alleged rest or recreation his stenographer was with him and he kept in touch with the several plants of his various companies by telephone and telegraph. Ordinary men might envy him his wealth, but they did not appreciate the tremendous physical effort spent in obtaining it.



The Scranton Republican wrote as follows:

Few men in any community have achieved so early the place that this man has filled. He has made ineffaceable marks in this region of his home. His example of indomitable courage under disheartening circumstances, of undreamed success that left him still sunny of temperament, unspoiled and kind, is a heritage to his city that has its value. The example of his ever ready generosity and sympathy, his exceptional executive ability, will remain as a tribute to his memory. That Scranton has lost one of its foremost citizens is too sad a fact to need elaboration. He was a man of high ideals, a loyal friend and a worthy exponent of America's possibilities.

From the Scranton Truth we have:

When death robs a community of a man in the full vigor of middle life, of a man whose generosity aided a hundred and one worthy projects of a busy city and whose means were ample to gratify this desire to be generous, of a man who gave time and thought to the uplift of the locality that was always his home, that community has indeed sustained a loss. And it is such a loss that Scranton is now called upon to bear in the death of E. L. Fuller. Those who have had occasion to solicit funds for the numerous benefactions that distinguish this city, know that they were never turned away empty handed when application was made to E. L. Fuller. He was a wealthy man but he shared his wealth with the city of his choice. He possessed a genius for organization and a mind that could grasp the practical advantages of almost any proposition. On more than one occasion he utilized this ability for the benefit of the city. It was due to him more than to any other man that the State Hospital was located here, and his indomitable energy was applied to building up this institution after it had been located here.

---

#### MORTIMER BARTINE FULLER

The amount of real work which may be accomplished by well directed and well ordered effort, energy and ability has been shown most conclusively in the career of Mortimer Bartine Fuller, of Scranton, Pennsylvania, who, while just on the borderland of middle age, is connected officially with such a large number of important enterprises that it would seem almost a matter of impossibility for one brain to control them. He is the only child of the late Edward Laton and Helen M. (Silkman) Fuller.

Mortimer Bartine Fuller was born in Scranton, Pennsylvania, September, 1877. He received his preparatory education at Dr. Cann's School, now The School of the Lackawanna, and at the Lawrenceville School, Lawrenceville, New Jersey. He then matriculated at Princeton University, being graduated from this institution in the class of 1899. He is a member of the Tiger Inn Club, of Princeton. Upon his return to his home in Scranton he became actively identified with the many financial and industrial concerns with which his father was connected, and since the death of the latter in 1909 has succeeded to the presidency of the International Salt Company of New Jersey and of the subsidiary companies. His other business connections are: President of the Detroit Rock Salt Company, the Empire Limestone Company, Genesee and Wyoming Railroad Company; director in the Marine National Bank of Buffalo, Scranton Savings Bank, Dime Bank of Scranton, Spencer Heater Company of Scranton, Scranton Life Insurance Company, and the Mason-Seaman Transportation Company of New York. Like his father, he is a philanthropist of high standing. He is trustee and treasurer of the State Hospital at Scranton, an office his father filled many years, and of which his grandfather was also the incumbent when the institution was known as the Lackawanna Hospital. He is a member of the board of directors of the Young Men's Christian Association, and a liberal contributor to the funds of this worthy organization. His religious membership is the Second Presbyterian Church, in which he is a member of the board of trustees. His social membership is: Director and secretary of the Scranton Club; director in the Scranton Country Club; mem-

ber of the Railroad Club of New York, Union League Club of New York, City Midday Club of New York, Princeton Club of New York, New York Yacht Club, Buffalo Club of Buffalo, Nassau Club of Princeton, Blooming Grove Hunting and Fishing Club, New England Society of Northeastern Pennsylvania and the Pennsylvania Society of New York.

Mr. Fuller married, in February, 1904, Kathryn, daughter of Joseph H. and Fannie (Van Derwerker) Steell, of Scranton, and they have children: Edward Laton, Mortimer Bartine Jr., Henry Q. Mr. Fuller has a clear conception of all affairs with which he is connected and the right regard for what is best in the exercise of human activities. With all the elements of a strong character, he shoulders his exacting responsibilities, and by his prudence, foresight and ability increases them largely in value. In all his relations—business, public and personal—he measures up to the standard of a splendid citizen.

#### HENDRICK ELSWORTH PAINE

The Paine family, represented in the present generation by Hendrick Elsworth Paine, numbered among the foremost citizens of Scranton, where he has resided for more than three decades, was planted by Stephen Paine on the rugged coast of New England in the year 1635, and his numerous descendants are to be found in many states of the Union, engaged in the various walks of life, performing well their part in whatever duties are assigned to them.

The family has furnished one signer to the Declaration of Independence, Robert Treat Paine. The name has been variously spelled: Paine, Payn, Paine and Payne, and it is first mentioned in Bloomfield's "History of Norfolk County, England," printed in 1316. This shire was the earliest recorded seat of the family, which traces its lineage to the ancient Britons, or Angles. The Elsworth family, related to the Paine family by marriage, claims among its members one who attained the honored position of chief justice of the United States Supreme Court, and another one that of governor of Connecticut.

Stephen Paine, the immigrant progenitor of the family, settled in Hingham, Massachusetts, in 1635, and the line from him to Hendrick E. Paine, of this review, is through the following generations: Stephen Paine, who removed to a little village then called Indian Seaconck, and changed the name to Rehoboth. Stephen Paine, removed to Pomfret, Connecticut, served in the old Colonial wars, fought at the battle of Louisburg, and was with Wolfe on the Heights of Abraham. Stephen Paine, removed to East Windsor, Connecticut, and was residing there at the time of the Revolution, serving in two enlistments. Eleazer Paine, born in East Windsor, Connecticut, served in the Revolutionary War, and later was commissioned colonel of the Nineteenth Connecticut Regiment, receiving his commission from the hand of Governor Jonathan Trumbull in the year 1803; he married Auriel Elsworth, daughter of Job Elsworth, of East Windsor, Connecticut. Colonel Hendrick Elsworth Paine, born in East Windsor, Connecticut, died at Monmouth, Warren county, Illinois, aged ninety-three years. He served in the War of 1812. He removed to Painesville, Ohio, with his parents in 1803, and he built the first forge for the manufacture of merchant bar iron that was erected in northern Ohio and thus became the pioneer ironmaster in a field that is now one of the greatest iron and steel centers of the world. In 1809 he married Harriet Phelps, a member of an old and distinguished Phelps family of Connecticut. Major Henry Paine, born in Painesville, Ohio, February 4, 1810, lost his life by an accident at the age of fifty-eight years. He succeeded his father in the management of the iron business, and was also engaged in the lumbering business and in farming. He married Harriet N. Tuttle, daughter of Ira and Charry (Mills)

Tuttle, of Ashtabula county, Ohio. Their children were: Elizabeth E., Auriel, Mary D., Charlotte L., Hendrick Elsworth, Ira T., Charry M., Harriet N., Stella A., Henry.

Hendrick Elsworth Paine, of this review, eldest son of Major Henry and Harriet N. (Tuttle) Paine, was born at Paine's Hollow, near Painesville, Ohio, March 12, 1845. He received a practical education in the district school, this knowledge being supplemented by attendance for one term at Madison Seminary, located near his home, and by a course of reading in the school library. In 1861, when President Lincoln issued his first call for troops to aid in defense of the Union, Hendrick E. Paine offered his services, but was refused on account of his youth, but in the following year he was accepted as a drummer boy in Company D, One Hundred and Fifth Regiment Ohio Volunteer Infantry. His term of enlistment was for three years, dating from July 31, 1862, but he was discharged for physical disability at Gallatin, Tennessee, February 26, 1863. In the following year, having recovered his usual health and strength, he again enlisted, this time for one hundred days, becoming a member of Company E, One Hundred and Seventy-first Regiment Ohio Volunteer Infantry. This time he served his full term, discharging his duties with signal ability and bravery, as he also did in his first enlistment, performing the duties of a soldier, although only enlisting as a drummer boy.

After his honorable discharge from the service of the government, he went to the oil fields of Pennsylvania, and for the following eighteen years he was actively engaged in drilling and operating oil wells, and mastered the business in all its details. He gradually advanced from one position to another, and in due course of time became the manager of companies amongst the most extensive in the oil field. He also operated on his own account, achieving a fair degree of success, and in 1882 he disposed of his oil wells, and retired from that line of business.

He took up his residence in Scranton, Pennsylvania, in 1883, and there engaged in the fire insurance business, his present line of work. Seven years later he admitted his only son into the business, changing the name to H. E. Paine & Son, its present style, and they conducted a general agency business, their field of operations covering all northeastern Pennsylvania. Mr. Paine has also given his attention to other lines of business, actively and prominently identified with several of the best known corporations of Scranton. He is a firm advocate of the principles of the Republican party, but he casts his vote for the candidate who in his opinion is best qualified for office, irrespective of party affiliation. He represented his ward in the city councils, his influence being on the side of right and justice, and he gives his earnest support to every movement calculated to benefit his adopted city. He holds membership in the Penn Avenue Baptist Church, in which he serves in the capacity of deacon; in Griffin Post, Grand Army of the Republic, the largest post of this order in the State of Pennsylvania; in the Sons of the Revolution; in the New England Society, being one of its charter members.

Mr. Paine married, December 25, 1866, Jennie L. Powers, daughter of Benjamin and Ann Powers, of Perry, Ohio. One child, Ernest Ira, born November 12, 1867. He is now the junior member of the firm of H. E. Paine & Son, and is also interested in other business matters with his father. He is past master of Peter Williamson Lodge, Free and Accepted Masons, of Scranton. He married, October 14, 1891, Nettie Moore, daughter of John and Fannie Moore, of Scranton. Children: Harriet Eleanor and Arthur Ernest.

## PHILLIP RINSLAND

Closely identified with important business enterprises in Scranton, Phillip Rinsland, present state inspector of dairies and watersheds, is a conspicuous example of a self-made man, who from an humble beginning has risen to a position of honor and influence. He has been a potent factor in the development of Scranton and has in all his enterprises shown an integrity of purpose and a public spirit that has won him an honored name among his fellowmen.

Phillip Rinsland is a son of John Rinsland, born in Oppenheim, Germany, who came to the United States, settling first in New York City. He followed his trade of tanner in New York and Susquehanna, Pennsylvania, residing in the latter place in 1883, when he met his death at Carbondale, under the wheels of a passenger train, he being then in the employ of the Delaware & Hudson Railroad Company. He was fifty-two years of age at the time of his death, a Republican, and a member of the Independent Order of Odd Fellows. He left a widow, Victoria (English) Rinsland, and children: Louis, Henry, Josephine, Phillip, Christine, Mary.

Victoria (English) Rinsland, born January 13, 1843, was the daughter of John English and his first wife, Barbara (Speizer) English, who died respectively, September 14, 1852, and July 15, 1846. John English, of German birth, came to New York City, where at No. 62 Bleeker street, he carried on an extensive tobacco manufacturing business for many years until finally selling out to the Lorillard Tobacco Company. He then moved to Liberty, Sullivan county, New York, where he resided until death. At the time of his removal to Liberty he overlooked a small favorable balance in the Bleeker Street Bank which was not discovered by his heirs until fifty-two years later in 1904, although the bank had regularly advertised the account each year. When rightful ownership was proven, the account was settled. John English married (first) Barbara Speizer, October 16, 1833; children: Mary, born June 19, 1835; John, September 9, 1837; Elizabeth, July 30, 1840; Victoria, January 13, 1843, married John Rinsland. By a second wife, Mr. English had Josephine, born November 19, 1848; Louis, September 10, 1851.

Phillip Rinsland was born at Callicoon, Sullivan county, New York, January 20, 1873. He was ten years of age when his father was killed and as there were three boys in the family, both older than Phillip, the main burden of the support of their mother and sisters fell at first on them. Phillip, however, added his, at first, small earnings to the family fund and as he grew in earning ability bore his full share of family expense. He was first a door tender in a coal mine, later a driver boy at Simpson & Watkins mine at Carbondale. He came to Scranton in 1883 and began learning the barber's trade in the shop of John Wahl, becoming an expert in that line. His education had not been neglected, but during the years outlined he had attended the public schools and improved his opportunities. He established a tonsorial establishment in Scranton after attaining proficiency at his trade, attracted a very large patronage and had the largest and best-appointed shop in the city. He prospered in business for several years, then disposed of his interest and devoted himself thereafter to the real estate business, later becoming senior partner of the firm of Rinsland & Jones and adding an addition to the city of Scranton in the Hyde Park district, devoting it to the best class of residential buildings. He also organized (1903) the Keiser Land and Improvement Company of Scranton, and in 1906 the All America Powder Company of which he is now a director. A close student of real estate values, Mr. Rinsland has made few errors in judgment in determining upon investments. He purchased the old Nettleton property at No. 920 Green Ridge street and there

erected "Rinsland's Hall," a three-story brick building with all modern safety and sanitary features, the third floor equipped for fraternal society uses of the Green Ridge section. The floor is now occupied by the Royal Arcanum, Junior Order of American Mechanics, Knights of Malta and the ladies' branch of the Modern Woodmen. He broadened out in other lines of activity, becoming one of the strong and active operators of the city. He is president of the Moscow Sand and Gravel Company, a director of the Clarks Summit Land Company, has interests in silver mines in New Mexico, gold mining interests in Montana, and was one of the founders of the Youngstown Hard Wall Cement Company, whose plant was erected in Scranton in 1905. These activities were carried on successfully and profitably, Mr. Rinsland being also the owner of valuable real estate in the city.

Mr. Rinsland's public service has been most valuable. He was elected city assessor over seventeen candidates and so worthily did he fill the office that he was continued therein nine years under three mayors and administrations. He was a most capable, just and upright assessor and withal so courteous and conscientious that he was regarded as a model official. After nine years' service in the assessor's office he was appointed state inspector of dairies and watersheds for Lackawanna county, and was appointed county detective, January 1, 1914, under George W. Maxey, district attorney. He is a life member of Scranton Lodge, No. 123, B. P. O. E.; member of Modern Woodmen of America; Junior Order of American Mechanics; Royal Arcanum; Knights of Malta; German Alliance of America and other organizations. He was an active member of the Million Dollar Industrial Development Company, city of Scranton. He is a member of the First Presbyterian Church, and a Republican in politics. For five years he served in the Pennsylvania National Guard, a member of Company H, Thirteenth Regiment. Highly as Mr. Rinsland is regarded for his business ability and official efficiency, he is not less highly esteemed as a friend and neighbor. Of genial personality and absolute friendliness to all, he has won a wealth of personal friends, and in all departments of his active life numbers among his warmest friends those who know him best.

---

### THOMAS SPRAGUE

The Sprague family of Scranton, represented in the present generation by Thomas Sprague, senior member of the firm of Sprague & Henwood, contractors and prospectors for coal and other minerals, is an old and honored family of Rhode Island, several generations of the family residing there, having been actively interested in various lines of work, and contributing greatly to the general welfare of the communities in which they resided.

(I) Thomas Sprague, the first of the line herein recorded of whom we have definite information, was a native of Providence, Rhode Island, and there spent his entire lifetime, honored and esteemed by his business associates and personal friends. In early life he led a seafaring existence, being captain on a merchant vessel, and later turned his attention to the cotton manufacturing business, establishing a mill in the vicinity of Providence, and in due course of time this section became sufficiently inhabited to become a village, to which was given the name of Spragueville, in honor of Thomas Sprague. The business prospered under his competent management, and he became a man of considerable means, wielding an influence for good in that section of his native state. He married Sarah Fenner, and among their children was Edward H., of whom further.

(II) Edward H. Sprague, son of Thomas and Sarah (Fenner) Sprague,

was born in Providence, Rhode Island, in 1812, died in 1891. After completing his studies in the schools of his native city, he followed in the footsteps of his father, becoming a cotton manufacturer, conducting his operations in Woonsocket, Rhode Island, and while a resident of that city he served in the state militia, taking part in the suppression of the Dorr rebellion in 1842. He removed to Boston, Massachusetts, in 1861, and was instrumental in founding the Manufacturers' Mutual Fire Insurance Company, which became one of the strongest companies in its line in the east, and of which he was secretary to the time of his death. He was a member and vestryman of St. Mark's Church in Boston, and was a Republican in politics. He married Clara P. Smith, a native of Middlebury, Vermont, daughter of Reuel P. Smith, and they were the parents of eight children, among whom was Thomas, of whom further.

(III) Thomas (2) Sprague, son of Edward H. and Clara P. (Smith) Sprague, was born in Woonsocket, Rhode Island, May 15, 1845. He attended the schools of his native place, acquiring a practical education which thoroughly qualified him for the active duties of life. His first employment was with the Boston & Albany Railroad, and later he was in the service of the Pennsylvania Railroad, in Ohio, the Hartford, Providence & Fishkill Railroad, the New York & New England Railroad, and the New York, New Haven & Hartford Railroad, thus being employed from 1867 to 1886, a period of nineteen years. In the latter named year he located in Scranton, Pennsylvania, and engaged in coal operations with the late William T. Smith, of the Mt. Pleasant and Sterrick Creek collieries, and continued in that relation until 1900, when he entered into partnership with W. L. Henwood, under the style of Sprague & Henwood, in partnership with W. L. Henwood, Inc., succeeding to the business of H. P. Simpson, and have successfully executed many large contracts for drilling for coal and iron mining companies, railroad companies and individuals. In these undertakings they have used with entire success a most excellent device known as the Diamond Drill, which bores a perfectly straight smooth hole to any depth and in any given direction from vertical to horizontal, bringing to the surface a solid section or "core" of all strata passed through, in order, revealing their exact individual depth, thickness and character of all stone or other deposits passed through, thus affording accurate knowledge of the material to be encountered in sinking a shaft, and providing data for a close estimate of the cost of sinking the shaft, and an approximate idea of the value of the workable mineral strata. Mr. Sprague is a man of keen judgment and foresight, essential characteristics in the man who follows his line of work, and being careful and methodical in all his habits, has become recognized as a safe counsellor in everything pertaining to mining operations, and this fact has gained for him the patronage of an extensive and representative clientele. He is also serving in the capacity of director and vice-president of the People's Bank of Scranton, and he was a director and president of the board of trustees of the State Hospital at Scranton. He is a member and vestryman of St. Luke's Protestant Episcopal Church, a member of the Scranton and Engineers' clubs, and a staunch adherent of the principles of the Republican party.

In 1862, shortly after the breaking out of the Civil War, when he was seventeen years of age, he displayed his love of country by offering his service in her behalf, enlisting in Bigelow's Massachusetts Battery, actively participating in all the engagements in which it took part, including the battles of Gettysburg, the Wilderness, Spottsylvania Court House, Bethesda Church, the operations against the Weldon Railroad, and against Petersburg and Richmond. He received an honorable discharge from the service of the United States

government in June, 1865, at the cessation of hostilities. Mr. Sprague is a representative of that class of citizens who are worthy of the respect and esteem of their fellows, men who labor earnestly to build up our business enterprises, who give employment to the masses, and whose efforts in life have tended to make Scranton a great mercantile and manufacturing center.

Mr. Sprague married Frances E. Duncan, daughter of Samuel Duncan, of Columbus, Ohio, and they are the parents of two daughters: Grace D., wife of Jerome W. Leverich; Gertrude H., wife of Nelson R. Osborne.

---

#### WILLIAM SWEET

Although a native of England, and responsible to that country for his education and the calling of which he is so able a master, the business life of William Sweet is entirely a story of American endeavor. His father, George Sweet, was born in Cornwall, England, and throughout his entire active life was manager and gamekeeper of a large estate in his native land. In the capacity of superintendent all matters pertaining to the cultivation of the land were brought to him for approval and advice, and he became an authority upon the relation of soil and crops, being thoroughly informed as to the effect of ground containing certain ingredients upon grains and food-stuffs and the chemical explanation thereof. He married Lydia Hawke, their children being: Thomas, a resident of New York City; George, lives in Lock Haven, Pennsylvania; Samuel J., of Denver, Colorado; Emma, married E. D. Webster, and resides in Denver, Colorado; William, of whom further.

William Sweet, son of George and Lydia (Hawke) Sweet, was born in Cornwall, England, November 27, 1862. After completing his youthful studies he became apprenticed to the British government to learn the art of stone cutting, the seal of Queen Victoria being attached to his indenture. Having learned this trade he immigrated to the United States, arriving in Philadelphia, Pennsylvania, on November 1, 1881, there obtaining work at his occupation, then moving to Danville, Pennsylvania, remaining in the latter place for two years. From that time until September, 1889, he traveled in the pursuit of his calling, working in nearly all of the large cities from the Atlantic Coast to the Rocky Mountains, and since the latter date has been engaged in stone cutting contracting in Scranton. He is one of the best in his line of business, his delicate work adorning many stately and imposing edifices in all parts of the country. Mr. Sweet's worth as a citizen and qualities of upright manhood have been recognized by his associates in his nomination for the state legislature on the Prohibition ticket, also a candidate for county prothonotary of Lackawanna county, and he is assured of the support of many of the best and most loyal citizens of Scranton. He holds membership in the Church of the Good Shepherd (Episcopal), and belongs to the Masonic Order and to the Sons of St. George and Knights of Malta.

Mr. Sweet married, April 14, 1886, at St. Stephen's Church, Wilkes-Barre, Pennsylvania, Lydia, daughter of Francis Hawke, of Cornwall, England. Their children: 1. William George Francis, born at Wilkes-Barre, Pennsylvania, March 13, 1887. 2. Samuel Edward, born June 30, 1888, at Meshoppen, Pennsylvania. 3. Philip Anthony, born at Black Walnut, Pennsylvania, August 25, 1889. 4. Robert John Stephen, born March 12, 1891 at Tunkhannock, Pennsylvania. 5. Henry Thomas, born June 10, 1893, at Tunkhannock, Pennsylvania. 6. Ewart Gladstone, born at Nicholson, Pennsylvania, October 11, 1895. 7. Herbert Nelson Hawke, born at Nicholson, Pennsylvania, February 25, 1898. 8. James Paul Ethelbert, born in Scranton, Pennsylvania, March 25, 1900.

## WILLIAM S. MEREDITH

This Welsh family in Pennsylvania has held residence mainly in Schuylkill and Lackawanna counties, although those bearing the name have found homes in other localities within the borders of the state, others going beyond its limits.

(I) The first of the line in the former region was Thomas Meredith, a native of Wales, who upon immigrating to the United States settled in Tamaqua, Pennsylvania, in that state passing his remaining years. He married ————. Children: 1. Jane, married William Watkins, a soldier of the Union army in the Civil War, who was wounded in action, his death resulting from the injury thus received; they were the parents of George, Fred, Edith. 2. Mary, married Thomas Samuels, of Wilkes-Barre, Pennsylvania; children, Meredith, M. D., Carrie, Catherine. 3. Hattie, married Charles Keech. 4. Deborah, married Monroe Brundage. 5. Thomas G., of whom further.

(II) Thomas G. Meredith, son of Thomas Meredith, was born in Tamaqua, Schuylkill county, Pennsylvania, in 1849, and when a lad accompanied his parents to Scranton, the family settling on the Von Storck Slope, father and son obtaining mine employment. Thomas G. Meredith later engaged in general farming operations, residing in Providence and Leggett's Creek, and afterward went to Brisbane Shaft, there being employed as engineer until his death. He married Mary Evelina, daughter of William Anderson, of Providence, Pennsylvania, and had children: 1. George Lester, a druggist of Providence, Pennsylvania. 2. Eva, married a Mr. Schwartz, and resides in Dunmore, Pennsylvania; children: Gertrude and Ethel. 3. William S., of whom further.

(III) William S. Meredith, son of Thomas G. and Mary Evelina (Anderson) Meredith, was born in Providence, Pennsylvania, August 31, 1878. In his boyhood he attended Public School No. 25, of that place, and his first employment was in the breakers of the neighboring coal mines. He then became errand boy for the Green Ridge Lumber Company, next returning to his studies at school. After leaving school permanently he was employed in a meat market until he was twenty years of age, when he passed a short time in Middletown, New York, as agent for the Grand Union Tea Company. Returning to Providence, he established a meat market, in partnership with F. F. Hendrickson, at the corner of Parker street and North Main avenue, and a short time afterward purchased the interest of his partner, continuing the business under his own name. In 1902 he sold his business in Providence, and forming a partnership with Herbert Day he founded a business of the same nature in Binghamton, New York, of which they later disposed. Upon once more returning to Scranton, where he has since remained, he was placed in charge of the meat department of George A. Dickerson's establishment, subsequently buying out his employer. Of this store he was the proprietor until his retirement, September 1, 1914, handling a full line of groceries and meats, transacting business under his name, the excellent appearance of both departments of his store making a favorable impression upon patrons, freshness and cleanliness predominating. Mr. Meredith was a genial merchant, possessed a wide acquaintance, and personally attended to the details of management of his store, taking pride in its appearance of immaculate order and tastefully arranged displays, the market value of which he had a full realization and appreciation. Mr. Meredith holds membership in the Presbyterian church, and in political action is independent of any organization associations, his vote at the polls being cast entirely according to his judgment. He be-



longs to Celestial Lodge, No. 833, I. O. O. F., and Hiram Lodge, No. 261, F. and A. M.

Mr. Meredith married Carrie C., daughter of Lewis Huff, of Providence, Pennsylvania, and has: Lewis, born May 7, 1905; Bernice, born November 10, 1909.

---

#### MYRON STEPHEN KNIGHT

Mr. Knight claims Lackawanna county, Pennsylvania, as his birthplace, while his forbears claim New York state as their home, and there they bore their full share in the development and improvement of the communities wherein they resided.

(I) Nicholas Knight, the first of the line here under consideration of whom we have information, was born in New York state, October, 1754, died September 12, 1828, aged seventy-three years and eleven months. He was the son of \_\_\_\_\_ and \_\_\_\_\_ (Bennett) Knight, the latter named having been a relative of Hon. Ziba Bennett, formerly of Wilkes-Barre, Pennsylvania. Nicholas Knight married Elizabeth Case, and they made their home in Goshen, Orange county, New York. Among their children was Benjamin, of whom further.

(II) Benjamin Knight, son of Nicholas and Elizabeth (Case) Knight, was born in Goshen, Orange county, New York, December 10, 1797, died in 1892, aged ninety-five years. He spent his early life in Goshen and Monroe, New York, and in 1832, at the age of thirty-five years, removed to North Abington, Pennsylvania, at that time in Luzerne county, where he settled on a large tract of land, mostly new land, located near Wallsville, where he resided until 1856, when he moved to a smaller farm near Waverly, selling his farm to his son, Jeremiah D., and in 1888 he retired from active pursuits and removed to Waverly borough, where with his second wife he quietly spent the remainder of his long and useful life. With Benjamin Knight came various other families from Orange county, New York, and they being mostly Methodists they formed what was called "The Orange County Class," which convened in the Aylesworth school house in North Abington, and this was the foundation of the Methodist Episcopal church of Wallsville. Benjamin Knight retained his faculties to an advanced age, being able to hear very quickly when spoken to in a loud voice in his ninety-fourth year. He was a constant reader of the Christian Advocate of New York, and the Scranton Republican, these papers representing his church and politics. Mr. Knight married (first) Mrs. White, who was the mother of three children by her first marriage: Mrs. Mary A. Sherman, William and John White. By her marriage to Mr. Knight she became the mother of four children: Jeremiah D., of whom further; George B., Mrs. Elizabeth King, Mrs. Emeline Griffin. Mr. Knight married (second) \_\_\_\_\_.

(III) Jeremiah D. Knight, eldest son of Benjamin and \_\_\_\_\_ (White) Knight, was born in Orange county, New York, July 15, 1826, died April 25, 1906, aged seventy-nine years. He came to Pennsylvania with his father, the latter settling on a farm adjoining the Benton township line, and about the age of twenty-one years Jeremiah D. purchased this farm from his father for the sum of twelve thousand dollars. In the spring of 1869 he moved to Clarks Green, Pennsylvania, and was there engaged in the cattle business, shipping five to six car loads of cattle per month from Buffalo and selling to the butchers of Scranton. During the panic of 1873 he gave up the cattle business and turned his attention to the dairy business, operating an extensive dairy on both his farms. He was a great horse fancier and usually had from twenty

to thirty head of horses and colts. At the death of his second wife, in 1884, he sold most of his horses, keeping only three or four driving horses, in which he took the greatest pride, and rented his farms. Within a year of his death he drove a pair of registered geldings that could step together in 2:30, and it was a source of great irritation to him if any one passed him on the road, which very rarely occurred. He married (first) Delilah Ann Parker, born June 10, 1836, died November 23, 1865, aged twenty-nine years, of pneumonia. She traced her ancestry to John Parker, born September 18, 1747, and his wife, Tabitha Parker, born December 17, 1747; among their offspring were: Charles, born July 27, 1777, died March 25, 1872, and Stephen, born October 27, 1779, and the line is traced through Stephen Parker, son of the above named Charles, who was born May 10, 1810, died July 21, 1893; he married Asenath Parker, his cousin, and daughter of the above named Stephen Parker, born August 30, 1814, died June 20, 1890, and they were the parents of Delilah Ann, above mentioned. Mr. and Mrs. Knight were the parents of three children: Elmer Wilmot, born in 1858, died July, 1906, after an operation for appendicitis; Myron Stephen, of whom further; Charles B., born in 1864, manager for the Union Central Life Insurance Company for Greater New York. Mr. Knight married (second) in 1868, Emily A. Clark, of Clarks Green, Pennsylvania.

(IV) Myron Stephen Knight, son of Jeremiah D. and Delilah Ann (Parker) Knight, was born in North Abington township, Lackawanna county, Pennsylvania, June 3, 1861. He was educated in the public schools and at Keystone Academy, later thoroughly qualifying for the profession of civil engineer. In 1881 he began his business career in the mine department of the Delaware, Lackawanna & Western Railroad, continuing until 1882, and from then until 1889 was connected as civil engineer with the construction of the Erie Railroad branch, from Hawley to Pittston, Pennsylvania. From 1889 to 1891 he was engaged on the construction of the Scranton branch of the New York, Ontario & Western Railroad. In the latter named year he established an office in Scranton as consulting engineer, and in 1892-93 was employed in building the Wilkes-Barre and Eastern Railroad. From 1894 to 1904 he was engineer of the borough of Dunmore. During the years 1895-96-97 he was also engaged in surveying the road from Fort Plain to Richfield Springs, New York, and in the mining department of the Lackawanna Iron and Steel Company. On April 1, 1897, he entered into partnership with George E. Stevenson, of Waverly, Pennsylvania, an association that still exists. The firm is Stevenson & Knight, Civil and Mining Engineers, 725-26-27-28 Connell Building, Scranton. They are well established in business and have an enviable reputation for ability, skill and integrity. Mr. Knight is a member of the Presbyterian church, of Dunmore, King Solomon's Lodge, Free and Accepted Masons, all bodies of Keystone Consistory, Ancient Accepted Scottish Rite, in which he holds the thirty-second degree, and Irem Temple, Nobles of the Mystic Shrine, of Wilkes-Barre. He is also a member of Scranton Club, Scranton Country Club, Green Ridge Club, Temple Club, Engineers' Club of Northeastern Pennsylvania, and American Institute of Mining Engineers.

Mr. Knight married, January 23, 1880, Linda S. Fowler, born September 1, 1868, daughter of Professor Leroy R. and Lamira Fowler. Children: Leroy F., born August 26, 1895; Gladys D., born August 18, 1901.

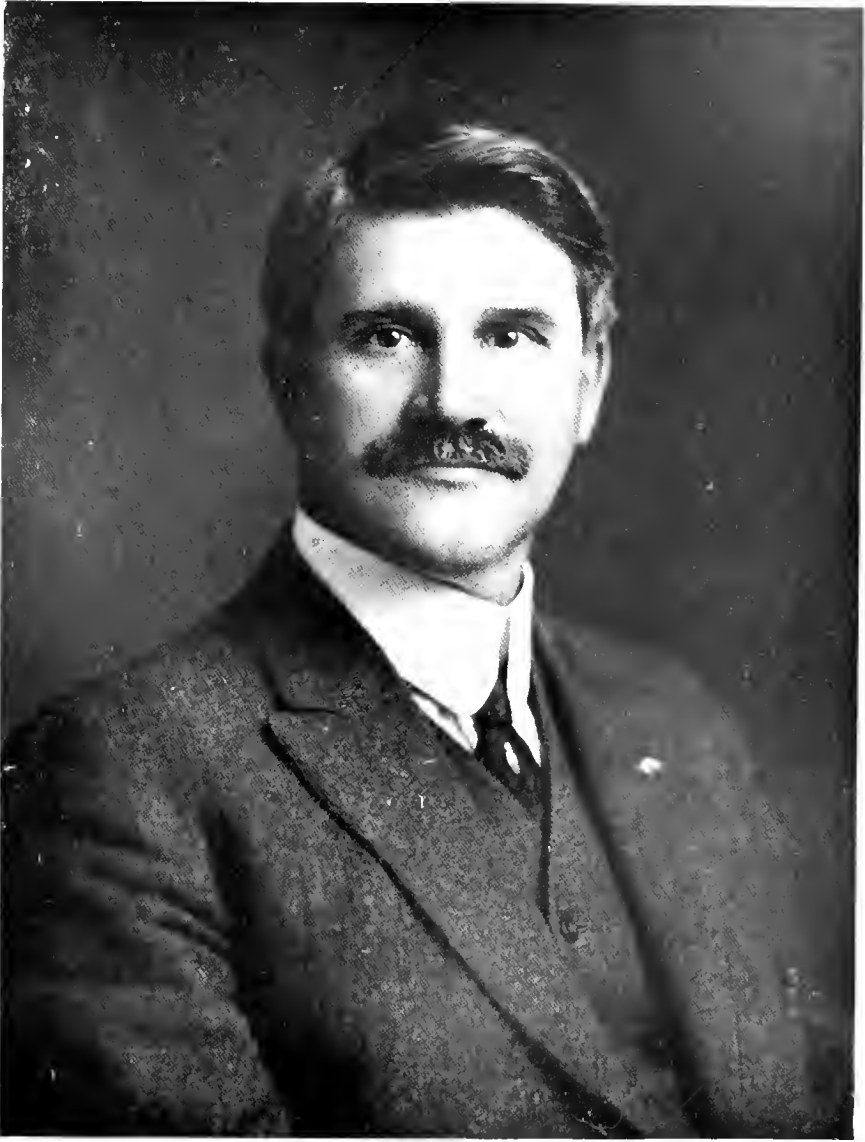

*Myron S. Knight-*



JOHN A. MEARS

JOHN F. MEARS

Much of the best in American life, customs and civilization has come to this country from the British Islands. Not only have the benefits of their older civilization come to us, not only have we learned from them in a few decades what it took the people of those lands centuries to learn, not only have they paved the way for a greater intellectual and material advance on this side of the ocean, but these countries are constantly sending to us the strength and sinew of their lives, their young men. By this heroic transfusion of the only power that can give a nation permanence and vigor we are strengthening ourselves at their expense. Scotland is one of the countries to whom we owe a great debt for service of this kind, for from her shores have come hundreds of youths who have given fully of their vigor and strength to their adopted country.

(1) Among those of Scotch ancestry who have come to the United States from their homes in that land was Sidney C. Mears, who emigrated at about the same time as the Linen and Bryden families, settling at Greenfield, near Carbondale, Pennsylvania. In 1856 he moved to Hyde Park and became a general contractor in the employ of the Delaware, Lackawanna & Western Railroad, specializing in the planning and construction of bridges. This one of his talents he willingly offered to the federal government at the time of the Civil War, and he was in Sherman's army in the capacity of bridge builder when it made the historic march from "Atlanta to the Sea." In that campaign some of the finest and most difficult work of his career was performed, since to construct a temporary structure of sufficient strength to bear up the marching hosts with the limited materials at hand meant a triumph of engineering and constructive skill. At the close of the war he returned to his position with the Delaware, Lackawanna & Western Railroad Company, continuing with that road until a few years prior to his death. He was an earnest, devout member of the Presbyterian church, as was his wife, Janet (Affleck) Mears, whom he had married as a widow, and who bore him seven children.

(II) John A. Mears, third child of Sidney C. and Janet (Affleck) Mears, was born at Greenfield, Pennsylvania, April 11, 1849, and there died April 24, 1905. He was educated in the public schools, and early in life learned the trade of carpenter, at which, however, he did not long continue, obtaining a position with the concern that had formerly employed his father, the Delaware, Lackawanna & Western Railroad Company. He became superintendent of stone construction between Scranton and New York, remaining in this position for many years. For a time he was contractor on the Binghamton division of the road with John Flynn, with whom he afterward organized the Old Forge Coal Company, miners and shippers of coal at Pittston, Pennsylvania. In 1893 Mr. Mears severed his connection with this company by the sale of his stock, then began his operations in and about Scranton. He attained wide prominence in the city and held interests in many of the local business and industrial institutions, also having position upon the directorates of the Moscow Water Company, the Fairview Park Land Company, the Honesdale Water Company, the Nicholson Water Company, the Halstead Water Company, the Great Bend Water Company, and was president of the Alex Car Replacer Manufacturing Company, also for a time being president of the People's Coal Company. In 1896 the Mears Building, the first ten-story office building to be erected in Scranton, was completed, a structure that will long stand as a monument to his business achievements and constructive ability and as a memorial to one of Scranton's most progressive, energetic and successful men

of affairs. He was identified with the Masonic Order, and passed all of the chairs of Hyde Park Lodge, Free and Accepted Masons.

Mr. Mears, in business foresight and sagacity, stood without peer in the business world of Scranton. In his wisdom and judgment he prospered, and seizing upon the opportunities that lay at his feet, made each a link in his splendidly formed chain of success. Those who were associated with him in business and those who were acquainted with the moves of his active life are aware of the high moral force that predominated in his character, which, translated into spotless integrity, made uprightness and honor the principles that governed his every transaction.

John A. Mears married, November 12, 1888, Eva V. Farnham, born in Taylor, Pennsylvania, daughter of Alpheus Farnham, a lumber dealer and mill owner of Benton, Pennsylvania, afterward connected with the Delaware, Lackawanna & Western Railroad Company. Of the children of John A. and Eva V. (Farnham) Mears, but two survive, John F., of whom further, and Frances, married Warren Acker and has one child, Marion F., her husband engaged in insurance dealing in Scranton. Mrs. Mears is a member of the Presbyterian church, her husband having been a believer in the Presbyterian faith.

(III) John F. Mears, son of John A. and Eva V. (Farnham) Mears, was born August 6, 1883, and was educated in the Scranton public schools and at Cornell University. Charge of his father's estate supplies him with responsible business duties, and he has become vice-president of the Anthracite Traction Company. To him has descended much of his father's business talent and surety of judgment, and in him will be found a worthy successor to his honored sire. He fraternizes with the Masonic Order, in which he has held office. His church is the Second Presbyterian. He married Ruth C., daughter of O. H. Loomis, of Meshoppen, Pennsylvania, and is the father of two sons, John F. Jr. and Theodore L.

---

### JAMES H. RITTENHOUSE

In the world in which James H. Rittenhouse has cast his lot and has made the impression always left by true worth and merit, in a community where men are judged and take place with their fellows each according to his ability, there is little time and less attention given to ancestry. In the myriad activities of a large manufacturing centre, in the midst of constructive operations of stupendous size, surrounded on all sides by the roar of industry, and enveloped in the rush of progress, a man may be of royal blood and yet, if in the contest he is found wanting, he is cast aside with no more consideration than is given a piece of machinery in which a flaw has been detected. Nevertheless, to one who has been a part in the vast enterprises that have centered in Scranton, and has acquitted himself in a manner highly creditable, it is fitting that space be given to his honored forbears.

The family of James H. Rittenhouse traces with perfect authenticity to Mathias Rittenhouse, of Holland, the surname originating when in 1591 he was knighted. The third generation following Mathias, Wilhelm Rittenhouse, came to America in 1688, founding the family that has since become so strong, both in numbers and in achievements, the descent to the present generation being through William, Nicholas, Mathias, Benjamin, David and Benjamin Franklin.

The father of James H. Rittenhouse, Benjamin Franklin Rittenhouse, was born at Milton, Pennsylvania, August 7, 1805, died in 1883. When a young man he received an appointment in the register's office of the treasury de-

partment from his uncle, Michael Nourse, who was placed in the government service by appointment of President George Washington. For sixty-two years he was employed in that office as chief clerk, a record of constancy, loyalty and fidelity seldom equalled. He married (first) in 1829, Isabel, daughter of Dr. James and Elizabeth Scott Laurie, both natives of Scotland and residents of Washington. She died in February, 1833. He married (second) Henrietta Waring, daughter of James and Mary (Higginbotham) Davidson, the marriage ceremony being performed by the Rev. Hawley, an Episcopalian minister, of Washington, D. C. Children of Benjamin Franklin Rittenhouse by his first marriage: Elizabeth Scott, married William Henry Fitzhugh Gurley; S. Emily; Isabel Laurie, married Joseph Harvey Nourse. Children of his second marriage: Mary Davidson, married A. Miller Woods; Henrietta Waring, married Captain Thomas Wilson, United States army; Benjamin Franklin, brevet major United States army, married Elizabeth Shapter; David Rittenhouse, married Mary Tilghman Earle; Clementine Crawford, married Dr. Richard S. T. Cissel; James Delozier, married Dolores Casillas; Helen Murray; James Hall, of whom further; Charles Edwin, married Helen S. Good; John D., died in infancy.

James Hall Rittenhouse was born in Washington, D. C., February 13, 1851, and was there educated in the public schools, later attending Lafayette College, whence he was graduated in the class of 1872. He soon after established in Scranton as a civil and mining engineer and there continues at the present time in partnership with his son, Leonard Cole. In the pursuit of his profession of civil engineer he has been employed by several railroad companies in laying new road, among them the Ontario & Western Railroad Company, also performing all of the engineering work on the Laurel Line Railroad. He has also made surveys of many iron mines in the Adirondacks and in New Jersey, as well as of the zinc mines in the latter state. In 1892 he was engineer in charge of the construction of the Winton dam and has also sunk many coal shafts. In both branches of his profession his work has been ably and thoroughly performed, to the satisfaction of the numerous corporations and companies that have engaged his services.

Mr. Rittenhouse married, in 1878, Ida Cole. Children: Lucia, born May 3, 1879, married Dr. Charles G. Shoemaker, of Washington, D. C.; Rulp, died in 1903; Leonard Cole, born October 31, 1884, associated with his father in business; Karl David, born March 2, 1888, an employee of the Lehigh Valley Coal Company.

---

### JOHN LINCOLN LUTSEY

When the commanders of the English army which was striving to quench the flames of liberty that were raging in the heart of every American during that terrible revolutionary period called upon their ruler for reinforcements and the paid hosts of the Germany army were pressed into service in answer to their call, little did they imagine the ultimate consequences. To them the Hessian troops were but instruments of war, to be used and returned to the government from which they were obtained, instead, many remained in America when the conflict was over and became the heads of families that are today among the proudest in the United States. When an army leaves conquered territory there are always stragglers who remain behind in the hope of acquiring spoils and booty, but such was not the case with those who deserted from the departing English army, for two reasons, the victory of the colonies and the impoverished condition of the land after the ravages of seven years' warfare. Those who left their regiments to take a part in the erection of a

government they had fought desperately to prevent did so because the undying spirit with which the colonists had striven for a principle by which they were determined to stand or fall had inspired their enemies with respect and honor, and had given birth to a desire to share in the greatness and prosperity of a nation with a foundation of so sturdy and so enduring a fabric.

(I) Such an one was John Lutsey, and the ship that carried away his former comrades carried with it all the allegiance he owed by pledge to England, or by birth to his mother country, and left him, in spirit, sympathy and fact, an American. He soon after married, in Connecticut, a widow, Mrs. Elizabeth Gilbert, and settled in Slocum township, Luzerne county, Pennsylvania. Although war had formerly been his trade, and despite the fact that he had held membership in the most dreaded of military bodies, the German Hessians, he made one of the gentlest arts of peace, farming, his occupation, and was so engaged at his death.

(II) William Lutsey, son of John and Elizabeth (Gilbert) Lutsey, was born in Slocum township, Luzerne county, Pennsylvania, and there followed the same occupation as his father, the tilling of the soil. The larder of the families of those days was more often dependent upon the rifle of the master of the house than upon a local butcher, and William Lutsey gained a local reputation for his accuracy of aim and his skill as a hunter. He married Rachel Payne.

(III) Edward Lutsey, son of William and Rachel (Payne) Lutsey, was born in Slocum township, Luzerne county, Pennsylvania, April 7, 1826. He was educated in the place of his birth, and in early life followed agriculture as a livelihood, abandoning this to establish as a merchant in Wilkes-Barre, Pennsylvania. Not finding mercantile life to his liking he sold his business and moved to Clarks Green, once more becoming a farmer and so remaining until his death. He was held in high regard by his townsmen and neighbors, and was by them placed in many positions of public responsibility, among them the offices of supervisor and town clerk. His religion was the Methodist, and of the services of this church he was a regular attendant. He married Amanda, daughter of Stephen and Jane (Lines) Lee. Stephen Lee was a son of James Lee, one of the pioneer settlers of Newport township, Luzerne county, Pennsylvania. After his marriage, February 10, 1834, Stephen Lee moved to Delaware county, Ohio, where he purchased land, and as rapidly as the forest retreated before the swing of his axe, cultivated the cleared area. As other houses were built in the locality he was given opportunity to work at his trade, that of plasterer, at the same time giving needed attention to his farm. Six years later he returned to Luzerne county, Pennsylvania, locating in Wright township, where he erected a saw mill and purchased a farm, for twenty-two years engaging in the joint operation of his property. At the expiration of this time he moved to Wilkes-Barre and became the owner of a planing mill at the corner of Canal and North streets. He was the proprietor of this establishment at his death, June 12, 1874, aged sixty-two years. His wife's death occurred September 25, 1881, at her home on North street, where she had lived since her husband's death. Children of Stephen and Jane (Lines) Lee: Conrad, John R., Mary, Priscilla, Amanda, of previous mention, married Edward Lutsey. Children of Edward and Amanda (Lee) Lutsey: Nelson; Walter; Ida, married F. F. Sprague; Mary P.; Millie, died in infancy; John Lincoln, of whom further.

(IV) John Lincoln Lutsey, youngest child of Edward and Amanda (Lee) Lutsey, was born in Wright township, Luzerne county, Pennsylvania. He obtained an excellent education in the public schools of his native township, a Commercial College, and Wyoming Seminary, in which latter institution his





*J. V. Hutsey*



studies were completed. His first business experience was received in Jermyn in the employ of C. L. Bell as bookkeeper, in which capacity he served for four years. He next secured an interest in the Eureka Coffin Company and became treasurer of that concern, selling his interest after a connection covering a period of two years, and returning to his early occupation of bookkeeper, this time with the Glove Warehouse in Scranton, with whom he remained for two and a half years. In the five following years he was employed by W. A. McConnell and the International Correspondence Schools, holding a position with the latter corporation for four years. The Lackawanna Dairy Company was the next firm by which he was employed, and in that service he rose from a position as bookkeeper to the general managership of the business, discharging the duties of the latter position until April, 1911, when he resigned to take charge of a business he had recently purchased, and of which he is now president and treasurer under the name of J. L. Lutsey Company, manufacturers of ice cream and dealers in dairy products. This business, of which Mr. Lutsey is the able head, is located at No. 216 Adams street, and at Nos. 414-416 Kressler court is located his factory in which he has installed all of the latest and most improved machinery. As the leader of this enterprise and as the custodian of its funds Mr. Lutsey has proved himself the possessor of business ability of no small merit, and the company bearing his name reflects credit upon him from whom it derived its title. He is a Methodist in religious conviction and belongs to the Elm Park Church of that faith. Fraternally he affiliates with Electric Star Lodge, No. 290, I. O. O. F., of Clarks Green, and the Masonic order, belonging to Union Lodge, No. 291, F. and A. M.; Lackawanna Chapter, No. 185, R. A. M.; Scranton Council, No. 44, R. and S. M.; Coeur de Lion Commandery, Knights Templar.

Mr. Lutsey married, September 2, 1890, Georgianna Mary, daughter of Frank Gill, of Jermyn, Pennsylvania. They are the parents of one son, Samuel Francis, born May 1, 1894, was a student in the Scranton Technical High School, now with his father in business, also interested in electricity and wireless telegraphy.

---

#### WILLIAM A. HARVEY

Scotch ancestry and in the United States residence in New York and Pennsylvania has been the part of the family of Harvey of which William A. Harvey, for seventeen years an electrical contractor of the city of Scranton, is a member. For more than fifty years Scranton has been the home of the family founded in the United States by James Harvey, a native of Rutherglen, Scotland. James Harvey came to the United States when a boy and made his home in New York state, where he resided until his death, working for the greater part of his life at his trade of millwright. He married Janet Arbuckle, and they had children: John A., of whom further; William, deceased; Marion, deceased, married James Cartwright and is the mother of Janet, Helen, James; Susan, married James Seaman, and has children, Janet, James, Helen; Elizabeth, deceased, married John Blackwood, and had John H. and Harvey J.; James, deceased, unmarried.

(II) John A. Harvey, son of James and Janet (Arbuckle) Harvey, was born in Newburgh, New York, February 11, 1846, and when he was fifteen years of age came to Scranton, becoming a car-builder in the employ of the Delaware, Lackawanna & Western Railroad, afterward rising to the position of engineer with that road. Subsequently he became superintendent of repairs for the Scranton school board, being so engaged for fifteen years, and at this time is a carpenter employed by that board. He is a Republican in politics,

and a member of Union Lodge, Free and Accepted Masons, of which he is past master. He married Alice J., daughter of Charles Holstead, and has children: Harriet A., married Rev. W. J. Ford, a minister of the Baptist church who for several years held a charge in Scranton, and is the mother of Ruth and Helen; William A., of whom further; Alice V., married William J. Revell.

(III) William A. Harvey, son of John A. and Alice J. (Holstead) Harvey, was born in Scranton, Pennsylvania, March 28, 1874, and as a boy attended the public schools of Scranton and Dunmore. After a course in the Lackawanna Business College, he became associated with the Lackawanna Power Company, later forming connections with the Scranton Street Railway Company and the Wightman Electric Company. Then entering the Pennsylvania State College, he took a course in electrical engineering in that institution, and after his graduation accepted a position as superintendent of the electrical department of the New Jersey Magnetic Construction Company. After resigning from his position with this concern, Mr. Harvey established himself in an independent business in his native city as an electrical contractor, and in this he has since continued. The seventeen years that have elapsed since the founding of his business have witnessed its steady and vigorous growth, the vast amount of electrical work that has been done in the locality under Mr. Harvey's direction showing well the confidence that is placed in his knowledge and ability. So well was Mr. Harvey prepared by practical experience for the study of his profession that he was able to complete his course in the electrical engineering department of Pennsylvania State College in three years, the responsible position that he occupied immediately after his graduation having been offered him largely on the strength of the work he accomplished in that college. His study of his profession has been deep and scientific, and in the application of the knowledge thus gained he has put to excellent and practical use his mastery of that strange and powerful force that has so revolutionized the conditions of modern life.

Mr. Harvey is a member of the Scranton Builders' Exchange, the Scranton Electrical Contractors' Association, the Scranton Engineers' Club, the Temple Club, the Modern Woodmen of America, and holds the thirty-second degree in the Masonic Order, in that society belonging to Lodge, Chapter, Consistory and Shrine. His political faith is Republican. He married Rose E., daughter of John W. and Helen (Chase) Riley.

---

#### CHARLES BENJAMIN NOECKER, M. D.

To be a successful physician one must possess not only exceptional ability and skill in the diagnosis and treatment of disease of every form, but a genial and kindly disposition and tender and sympathetic heart, an acute sense of honor and integrity of a high order, all of which attributes are possessed in large degree by Dr. Charles Benjamin Noecker, a member of the surgical staff of the State Hospital at Scranton, Pennsylvania.

(I) John Noecker, grandfather of Dr. Charles B. Noecker, was born at Schuylkill Haven, Schuylkill county, Pennsylvania, there passed his entire life, following the occupation of agriculture, in which he was highly successful, and his death occurred there at the age of fifty-five years. He was a member of the Lutheran church, as was also his wife, and he was a staunch adherent of the principles of the Democratic party. His wife, Sarah (Reed) Noecker, who died at Schuylkill Haven, in 1897, aged eighty-eight years, bore him the following named children: Lewis, of whom further; Sarah, widow of Hiram Berger, of South Bend, Indiana; Mary, widow of William Reber;

Emma, wife of Samuel Dewalt, of Fort Wayne, Indiana; Fayette; Katherine, wife of Adam Schwenk, of Fort Wayne, Indiana.

(II) Lewis Noecker, son of John Noecker, was born in Schuylkill Haven, Pennsylvania, September, 1839. He grew to maturity on his father's farm, gaining health and strength from the out-door labor, and his education was obtained in the common schools of that day and place. Being inured to farm labor he chose that occupation for his life work upon attaining suitable age, and has successfully conducted operations on a farm located near Schuylkill Haven, his land being devoted to the raising of general produce. He followed the example of his father in politics, casting his vote for the candidates of the Democratic party, and he has filled one public office, that of school director, in which he served capably and efficiently. During the Civil War he displayed his patriotism by enlisting in the One Hundred and Forty-eighth Regiment Pennsylvania Volunteers, participating in all the battles and engagements in which it took part. He and his wife are members of the Lutheran church, in the work of which they have always taken an active interest.

Lewis Noecker married Mary Moyer, born at Schuylkill Haven, Pennsylvania, daughter of Philip Moyer, a prosperous agriculturist of near Schuylkill Haven, whose death occurred on his farm at the age of seventy-two years. He was the father of seven children, three of whom are living at the present time (1914): Mary, aforementioned as the wife of Lewis Noecker; Cornelius Moyer, a resident of Schuylkill Haven; William Moyer, a resident of Schuylkill Haven; Philip Moyer, who died at age of seventy-three; Mrs. Katherine Weaver, who died at age of seventy; Mrs. Matilda Kneer, who died at age of sixty-six; Mrs. Fayette Reber, who died at age of sixty-five. Ten children were born to Mr. and Mrs. Noecker: 1. Kate, a resident of Schuylkill Haven. 2. William, married Anna Koch; resides in Schuylkill Haven. 3. Frank M., married Cornie Hall; resides in Renovo. 4. James, an attorney-at-law; married Ethel Hancock; resides in Schuylkill Haven. 5. Sallie, became the wife of Frank Matz; resides in Harrisburg. 6. Charles Benjamin, of whom further. 7. George Alfred, a railway mail clerk; married Anna Berger; resides in Pottsville. 8. Carrie Ann, became the wife of Harry Nissley; resides in Hummelstown. 9. Lewis, a railway mail clerk; married Minnie Cramer; resides in Schuylkill Haven. 10. Mame Ida, became the wife of William Repp, an assistant manager of a typewriter concern; resides in Harrisburg.

(III) Dr. Charles Benjamin Noecker, son of Lewis Noecker, was born in Schuylkill Haven, Pennsylvania, February 8, 1874. He was reared on a farm located two and a half miles outside of Schuylkill Haven. He obtained an excellent education by attendance at the Schuylkill Haven High School, Kutztown State Normal School, and he prepared for the medical profession by a course in the University of Pennsylvania, graduating from the medical department in 1902. He began his active career at the age of seventeen by teaching in the public schools, serving in the capacity of teacher, a vocation for which he was well qualified, for a period of five years, during the summer months attending Kutztown State Normal School. The year following his graduation as Doctor of Medicine he spent in the State Hospital at Scranton, thereby adding greatly to the knowledge gained during his University course, and at the present time (1914) is a member of the surgical staff of the same institution. His devotion to his chosen calling is deep and abiding, and his success has been worthily achieved. He has acquired a high reputation among his professional brethren, and he is equally prominent in social circles. He keeps in touch with the advanced thought of the day by membership in the American Medical Association, the State Medical Association, and the Lacka-

wanna County Medical Society. Dr. Noecker is a Republican in politics. He married Victoria Connell.

The career of Dr. Noecker affords a most interesting example of the achievements of one who may be regarded as a worthy representative of a class of Americans whose versatile talent would command success in almost any field which they might choose to enter, and who rise to high place in that which ultimately claims their effort. Dr. Noecker is interested in all that pertains to the welfare of his adopted city, Scranton, is charitable and benevolent, and worthy demands of the needy are seldom made in vain. He has a large circle of appreciative friends, and in his professional capacity is well known throughout his section of the state, an honor to the profession by which he has been especially distinguished.

---

#### DR. WILLIAM E. ALLEN

Of all the professions that of medicine and surgery is perhaps the shortest-lived, and yet the most glorious and honored. There are many to criticize the enormous fees received by some physicians from the wealthy classes for important operations, yet they do not stop to consider how frequently the same physician will give his services entirely without remuneration of any kind, when the patient to be attended is one of the poorer class, and it is not of infrequent occurrence that a goodly share of the fee obtained from some wealthy patient is utilized to relieve the sufferings of one less fortunately situated. There is never a thought on the part of the physician that the time he spends in attendance on a patient who is unable to pay for such service might be better employed in looking after some rich patient; there is never a moment's thought of his own physical discomfort, when the physician is called out in all sorts of inclement weather; and many a brave man of this profession has knowingly gone to his own death in order to save another's life by his skill. A well known member of this noble profession, and one to whom the foregoing remarks are particularly applicable, was the late Dr. William E. Allen, of Scranton, Pennsylvania, one of the oldest and best beloved physicians of that city.

(I) Gabriel Allen, grandfather of Dr. Allen, was a sea captain by occupation, making his home, when on land, in Connecticut, where he was born. He married \_\_\_\_\_ Churchill, and they became the parents of six sons and four daughters.

(II) Rev. Edward Allen, son of Captain Gabriel and \_\_\_\_\_ (Churchill) Allen, and father of Dr. Allen, was born in Saugatuck, now Westport, Connecticut, June 8, 1792, died at Harford, August 1, 1877. His native town furnished the educational advantages which prepared him for entrance to college, and he then entered the junior class at Princeton College, from which he was graduated in the class of 1815. He became principal of the academy at Elizabethtown, New Jersey, and at Trenton, in the same state, continuing for three years, and during this time made an exhaustive study of the Hebrew language, in preparation for entrance into the ministry. Early in 1818 the Presbytery of New Jersey conferred upon him the license to preach, and toward the end of the same year he was ordained by the same body. He retired from the ministry in 1874, and for some years prior to his death conducted a family school for boys at Harford. He married Elizabeth \_\_\_\_\_.

(III) Dr. William E. Allen, son of Rev. Edward and Elizabeth Allen, was born in Wantage, Sussex county, New Jersey, October 8, 1836, died at his home on North Washington avenue, Scranton, Pennsylvania, in 1903. His earlier educational training was received at the Belvidere Academy, and

he studied Latin and Greek with his father; taking up the study of medicine with his brother, Dr. J. Linn Allen, of Branchville, Sussex county, New Jersey, he continued his studies at the Albany Medical College, and was graduated from that institution in the class of 1856, the degree of Doctor of Medicine being conferred upon him. One year was spent in the active practice of his profession at Milford, Pike county, Pennsylvania, and then failing health obliged him to abandon medical practice for two years. He purchased a drug store in Hyde Park, now West Scranton, and conducted this until 1859, when he opened an office there for the practice of medicine, and was identified with this for about forty years. The only interruption to this was the period he spent in military service during the Civil War. In July, 1862, he went to Fortress Monroe, as assistant surgeon, United States army, in the Chesapeake General Hospital. One and a half years were spent there, during the last third of this period Dr. Allen was the executive officer of the hospital. His health again gained the upper hand, and he was compelled to resign his position and return to his home. He re-entered the service in June, 1864, and his services were invaluable as an officer of the Christian Street Hospital, Philadelphia, until this institution was discontinued. Upon returning to his home he was appointed examining surgeon for the provost marshal of the Scranton district and filled this office until the close of the war.

Until ten years prior to his death Dr. Allen lived in West Scranton, in the old homestead at Price street and North Main avenue, which has since been destroyed by fire. There he built up his practice, which was the largest in the city, and no better reason can be given for his change of residence, than his own words, in speaking to a friend. They were:

I'm getting on in years, I can't expect to have many more years of hard work. I have given my best to the public; I have got to get out of this rut; I believe I can do better financially and not work so hard in the Central City; I love Hyde Park; I came here a boy, without health or money, almost gone with consumption; I have improved in health; grown up with the place; feel I have a father's care over hundreds of people; have unnumbered friends; have tried to do the square thing, but I am a comparatively poor man; I have an immense practice; keeps me going day and night, but I must shut down some time. Well, don't feel bad, if I do go over town, I'll come just the same to my old friends, but you see there are advantages over there I can't have here, and I must make a break, and I feel as bad as you do over the matter. I have been thinking a good deal about it. My best friends urge me to make the change. What to do about my accounts puzzled me a good deal. I had a man go over my books and make out a list of those who owe me. I looked them over. I made out four piles. One was marked good; the second, doubtful; third, bad; the fourth, charity. I looked over the second and third piles three or four times. I thought of the condition of each family, of their troubles and hardships, for your doctor knows a good deal of family secrets and a good many skeletons hidden away from others, and I got near to the stove, and threw in one bill after another, until the three piles were gone. They footed up thirty thousand dollars. Then I got new ledgers, transferred the good accounts, burned my old books, and have let all they contained that was unpleasant pass from my memory.

This line of conduct was in keeping with his actions throughout his life. Always alleviate suffering, was his watchword.

Dr. Allen was appointed health officer in 1886, by Colonel Ezra H. Ripple, then mayor of the city, and filled this office uninterruptedly until a bureau of health was created, when he was appointed superintendent of that body, and served throughout the administration of Recorder W. L. Connell, displaying extraordinary executive ability in the discharge of the duties of this office.

Dr. Allen married, June 6, 1865, Amelia B. Clapp, born at Athens, Pennsylvania, July 5, 1842, died at Clifton Springs Sanitarium, Clifton Springs, New York, in July, 1912, a daughter of Nathaniel and Cynthia Clapp, and they had one child, Julia, who survived her mother. Rich and poor alike sincerely

mourned the death of Dr. Allen, and we cannot show the high esteem in which he was held better than by giving a few extracts from the daily papers at the time of his death.

Thousands can testify to his faithfulness and skill as a physician and surgeon, and those thousands and other thousands counted him as friend and counsellor, and will mourn his passing. He has come as a bright star of hope to the bed of sickness, and when science could no longer avail, he eased the pain until the last sleep came. In the homes of the poor, at all hours, in all kinds of weather, without a thought or hope of remuneration, the good doctor responded as cheerfully and as faithfully as to the call from the mansions of the wealth. Not only free services, but medicines and financial aid, nursing and help came to many homes where sickness and poverty had laid their hands. Not ostentatious, but in so quiet a way, that the recipients did not know the donors, has the generous doctor come to homes. No friend could be truer or stauncher. Always ready to believe the good, censuring and condemning calumny and suspicion, broad and liberal in thought and deed, a nobleman, in the true sense of the word, was Dr. Allen. Gifted and learned, a fine conversationalist, with fund of anecdote and wide experience with men and things, he was a delightful companion.

Dr. Allen's reputation as a physician and surgeon was early established. It was of a high order and was so recognized by the medical fraternity. He was naturally a man of decided ability and strong individuality, such as would have won him distinction in any walk of life. He was more than a physician to hundreds of families. He was a friend and counsellor to them, always sympathetic, and ever ready to aid them. Those who knew Dr. Allen find no difficulty in accounting for the deep feeling of sorrow that followed the announcement of his death. His interesting personality, his philosophy, common sense and good cheer, make his loss wide spread in its influence.

He never wronged anyone in his whole, long, kindly life. He never did an injustice that was known to his gentle heart. He followed the Golden Rule if ever a man followed it in this age of the world, and the world is poorer since he left it. He might have made his life very different; he might have been grasping—have held much of the world's goods in his hands, but those hands were ever open and never closed to humanity's needs. There are many who are richer in health and richer in wealth because Dr. Allen lived.

---

#### LEONIDAS WILLIAM MORSS

It seldom occurs that remarkable capability for the conduct of large industrial affairs is found in the same individual, associated with highly cultivated literary tastes and such habits of life as permit of their enjoyment. A marked exception to the general rule was to be found in the person of the late Leonidas William Morss, of Scranton, Pennsylvania, whose business activities extended to numerous of the most important and exacting industrial interests of the Lackawanna Valley, yet who found abundant time for those mental pursuits which find their epitomization in the words of one of the deepest thinkers of old: "My mind to me a kingdom is." Coming from an excellent ancestry, his character afforded evidence of the stock whence he came, and there was witness to it in his physiognomy, showing, as it did, great strength of character, reserve energy and kindness of disposition. He was fortunate in his forbears, both in the land of their origin and that of their adoption; there and here they were men of intelligence and conscience, and led him into that avocation in which he conquered the largest measure of success. He was a son of Burton Gilbert and Caroline (Kirtland) Morss.

Mr. Morss was born at Red Falls, Greene county, New York, January 17, 1838, died suddenly, of heart trouble, at his home, No. 2115 North Main avenue, Scranton, Pennsylvania, November 20, 1912. He studied at the district schools near his home and under private tuition in preparation for his entrance to college, matriculating at Williams College in 1856, and being graduated from this institution with honor in the class of 1860. After graduation he returned to his native town, where he was employed in the cotton mills of his father until 1864, and then went to Ledgedale, Wayne county, Pennsyl-





*L. W. Wood*



vania, in which place his father was the owner of a large tannery, as well as of about twenty thousand acres of timber and bark land. This was a very important and profitable industry, and was managed by Mr. Morss with consummate ability for twenty years, until the death of his father, when he became the owner of this property. He disposed of it in 1893 to the United States Leather Company, and at that time removed to Scranton, Pennsylvania, where he made his home from that time forth. He was a man of many sided ability, and had he chosen to devote his talents to financial matters exclusively, would undoubtedly have become one of the "Napoleons of finance," of his generation. As it was, he was a leading spirit in the directorates of several banks, and he was also active in developing the interests of slate quarries. Some years prior to his death his health had become greatly impaired, and he was a frequent sufferer, but he bore his sufferings with the patience which characterized him in all the conditions of life.

Mr. Morss married, October 18, 1866, Merrilla E. Morss, a native of Carbondale, Pennsylvania, and they had children: George L., Louis R., Minnie E., Julian S., Mabel B., died June 17, 1877; Clarence R., Leigh M., Burton G. Mrs. Morss is a woman of high intelligence and cultivated mind and was in complete harmony with her husband in disposition, tastes and love for good works, and they were as one in thoughtfulness for the welfare of others, particularly for the needy and distressed, and counselled fully together in the disposal of their means in all charitable ways. It is pleasurable to note that she continues to bestow her benevolence with the same graciousness and liberality, and in the same unostentatious manner, many of her gifts reaching the beneficiaries so quietly that none others know of them. The conduct of Mr. Morss combined with a pleasing personality all that was dignified and courtly. Unassuming in manner, he was free from obtrusive self-assertion, and in his intercourse with his friends and familiars was delightful in conversation; fond of anecdote, possessing a rare store of information, a gentle humor that always bore testimony to his kindness of disposition, he was in his social life a most interesting and attractive companion. By such manners and qualities, by such a life, he made for himself an honorable career, and dying, left no stain nor tarnish upon the imperishable monument which he himself, while living, erected to the memory of a just man.

---

#### WILLIAM H. HAGEN

Henry Hagen, father of William H. Hagen, was born in Hagen, Germany, and when eight years of age came with his parents to the United States, settling at Honesdale, Pennsylvania, where he attended the public schools. As a young man he learned the trades of blacksmith and carriage builder, and was employed, soon after completing his apprenticeship, by the Delaware, Lackawanna & Western Railroad as tool dresser. He became a resident of Scranton, and was one of the first to enlist in the Thirteenth Regiment Pennsylvania National Guard, of which he was for many years a member. He affiliated with the Masonic fraternity. He married Marion, daughter of William Walsh, of Honesdale. Children: Louise, married George B. Carson, of Scranton; Ella, married Andrew Johnson, of Brooklyn; William H., of whom further; Frank, married Alice Deppen, of Scranton; Lillian, married Fred Wicks, a resident of Scranton. Mr. and Mrs. Hagen were members of the Simpson Methodist Episcopal Church.

William H. Hagen, son of Henry and Marion (Walsh) Hagen, was born in Scranton, Pennsylvania, September 27, 1861. He obtained his early education in the public schools of Scranton, and when a lad spent several years

in Newark Valley, New York, whither his family had moved and where they remained until 1873, when they returned to Scranton. In the latter named city Mr. Hagen entered the employ of Moore & Finley, merchants, and obtained considerable valuable experience in and knowledge of the mercantile business, training of the greatest benefit to him in his later life. In 1894 he and Joseph A. Mears established the business which has since become the Hagen & Wagner Company, as Mears & Hagen, their line being then, as now, dry goods and furnishings for men and women. From a concern employing six persons, their sales force now numbers seventy-five, and in September, 1914, they moved into their newly remodeled store on Washington avenue, now occupied by the Prendergast firm and the Jones' Tea Company. Mr. Hagen serves the Asbury Methodist Episcopal Church as a member of the official board and as trustee, also as superintendent of the Sunday school. He is a director of the local branch of the Young Men's Christian Association. His only fraternal connection is with the Masonic order, in which he holds the thirty-second degree, and is a member of Irem Temple, Nobles of the Mystic Shrine. He is president of the Scranton Rotary Club.

Mr. Hagen married Carrie Munson, daughter of William Munson, Children: Helen, married Leland Marsh, a resident of Scranton; Hoadley, a graduate of the University of Pennsylvania, class of 1912.

---

#### STEPHEN M. CONGER

Representative of his English family in Scranton, Stephen M. Conger is a native of Connecticut, his family old in New Jersey. In this latter state his grandfather, whose name he bears, Stephen M. Conger, was born, Newark the city of his birth, and there he was long a well-known carriage builder, a line in which his son, William H., continued during his active career. Stephen M. Conger was the father of: William H., of whom further; David M., Charles A., Stephen M., Charlotte M.

(II) William H. Conger, son of Stephen M. Conger, was born in Newark, New Jersey, and in manhood followed the calling that had previously claimed his father, carriage manufacturing. He was a loyal supporter of the Republican party. He and his wife, Charlotte E. Conger, she a native of Bridgeport, Connecticut, were the parents of: William A., born December 12, 1856; George H., September 16, 1857; Stephen M., of whom further; Frank W., October 12, 1863; Charlotte E., October 1, 1874.

(III) Stephen M. (2) Conger, son of William H. and Charlotte E. Conger, was born in Bridgeport, Connecticut, March 3, 1859. He was prepared for college in the public schools of New York City, and was later graduated from the University of the City of New York. His active business life has been passed in successful mercantile dealing, his present line in the city of Scranton, and he is highly regarded in this place as a business man of standing and reputation, his association with the business world of Scranton having been both pleasant and profitable. Mr. Conger's club is the Green Ridge, and he is a member of the Green Ridge Presbyterian Church. Politically a Republican, he is a member of the Royal Arcanum.

Mr. Conger married (first) January 7, 1887, at Bridgeport, Connecticut, Evelyn A. Holly, one child, Evelyn, born January 24, 1890, married L. A. Hamilton, and has one son, James Conger; (second) December 4, 1894, Morna M., born in Lockport, New York, daughter of George Perrigo; one child, Marcia, born December 29, 1897. George Perrigo was a journalist, and during the Civil War a lieutenant in the United States navy; he was the father of two daughters, Morna M., of previous mention, married Stephen M. Conger, and Meta E., married Thomas F. Kennedy, of Highland, Wisconsin.

## PHINNY D. CLANCY

For more than half of a century Scranton has known Phinny D. Clancy as a contractor and builder, and in the city that line, which has been the starting point of the growth of some of Scranton's most prosperous fortunes, has known no name to which more honorable record, in regard to excellence of work and fairness of dealing, attaches. This line of the family came to Pennsylvania from Maryland, Baltimore having been the place of birth of David Nelson, father of Phinny D. Clancy. David Nelson Clancy was a blacksmith in calling, and followed that occupation in Bradford and Susquehanna counties, his death occurring when he had attained the age of four score years, his wife, Mary (Stevens) Clancy, born in Dundaff, Pennsylvania, dying aged eighty-five years. They were the parents of thirteen children, Phinny D. the fourth of those.

Phinny D. Clancy was born near Raysville, Bradford county, Pennsylvania, June 29, 1840. In his youth he was a student in the public schools, principally in Susquehanna county, whither his father's business took the family, and upon the completion of his education he apprenticed himself to and mastered the trade of carpenter. This he did in Susquehanna county, Pennsylvania, and in 1860 moved to Scranton, where he at once established as a contractor and builder. The contracts that he has fulfilled in that time and the homes and other buildings that he has erected are almost without number, and he gained a reputation as a builder of reliability, one to whom the wishes of him for whom work was being done was of paramount importance and one whose judgment might be safely trusted. No inconvenience did he consider too great if by its incurrence the satisfaction of the future owner of the house or building upon which he worked might be heightened, and by the observance of such a policy of accommodation he grew in public favor. During his greatest activity in contracting and building, Mr. Clancy employed twenty-five men in his working force, but of late years he has gradually lessened his business dealings until most of his work is jobbing and repairing. For this he employs men trained in their trade, so that even in a day of modern methods, when rapidity of operation and showy architecture have superseded fineness and substantiality of labor, his name in connection with carpentering work will be sufficient guarantee of its quality. Mr. Clancy is a Republican in politics, and is identified with the North Main Avenue Baptist Church.

Mr. Clancy married, in Greenfield, Pennsylvania, Arminda Dann, a native of that place, daughter of Jonathan Dann, her father a pioneer of Greenfield, Pennsylvania. Mrs. Clancy died May 21, 1914, aged about seventy years. Children of Phinny D. and Arminda (Dann) Clancy: Etta, married Russell Emery, and has two children; Mary, married John Finnity; Bertha, married Burton Clease, and has two children; Alma, married A. J. Morgan, and has three children; Flora, died unmarried, aged twenty-four years; and two sons, who died in infancy.

---

WALTER A. McCONNELL

Canadian born and bred, it has been as a citizen of the United States and as a merchant of Scranton that Walter A. McConnell has achieved business success, having come to that city in his youth and there, after a short term as an employee, established in independent mercantile dealings. He is a son of Joseph McConnell, a retired hotel proprietor of Kingston, Ontario, Canada, where he was born. Joseph McConnell left home as a lad of twelve years, his first employment being as a driver on the Welland Canal, after which he moved

to New York City. Here, through his unaided efforts, he accumulated sufficient funds to embark in the hotel business, and after so engaging in New York for a time, returned to the place of his birth, purchasing a building three houses removed from that in which he was born and there opening a hotel. Of this hotel he was owner and manager until his retirement from active business, and attained prominent position in the community. Although no longer an extensive participant in local affairs, he bore with him to private life a record of upright integrity, a reputation of lifelong adherence to straightforward principles from which he has never been known to deviate ever so slightly, and the good-will and friendship of all who know him in any walk of life. Such is the regard in which, after years of acquaintance, his fellow-citizens hold Joseph McConnell. He is of Scotch-Irish descent, his father, a resident of Kingston, his mother having died at the age of eighty-six years, after bearing nineteen children, five of whom survive to the present time: Joseph, of previous mention; John; Mary, married John Newlands, and has a daughter, Jennie; Margaret, married William Hamilton, and is the mother of William and Harold; Elizabeth, married William Adair. Joseph McConnell married Elizabeth White, and has children: Robert J., deceased; Joseph A., deceased; John G., of whom further; Walter A., of whom further.

Walter A. McConnell, son of Joseph and Elizabeth (White) McConnell, was born in Kingston, Ontario, Canada, October 28, 1874, and was there educated. After his graduation from the public schools he was employed as parcel boy in a grocery store, soon afterward becoming cashier in the same store, leaving there after two years to come to Scranton to accept a position under his brother, John G., at that time manager of the Globe Warehouse. He remained with his brother for one year, then became associated with W. E. Smith, a merchant of the South Side, and after two years he decided to enter the mercantile field as the proprietor of an establishment, and purchased the business of G. A. Pyle & Company, at No. 1004 South Washington avenue. The business that he built up soon outgrew these quarters and Mr. McConnell bought the adjoining building, No. 1010, formerly occupied by his previous employer, W. E. Smith. Here Mr. McConnell has since conducted a general merchandise business, the expansion that made necessary larger quarters continuing in gratifying measure, his patrons numerous and regular. The strictest business principles prevail throughout the establishment, which is known for the uniformly high grade of goods handled and the unfailing courtesy accorded all customers. Mr. McConnell is a thirty-second degree Mason, also belonging to Irem Temple, Nobles of the Mystic Shrine, besides his Masonic associations affiliating with the Temple Club and the James Connell Lodge, Independent Order of Odd Fellows. His political party is the Republican, and he attends the First Presbyterian Church.

Mr. McConnell married Lydia, daughter of ex-County Commissioner William Franz, deceased, and has children: Robert, born November 5, 1898, a student in the Scranton High School, class of 1916; Lillian, born April 25, 1903.

---

#### JOHN G. McCONNELL

Schooled in business in Scranton, John G. McConnell has in that city put into practice that which he was there taught, his high position in the mercantile world of that place showing him to have been an apt pupil and one who could indeed "better the example" of his instructors. During his residence in Scranton success and prosperity as a business man are not all that he has achieved, for he has taken a firm stand for all of the best in the life



*John G. McConnell*





and activity of the city and is universally esteemed as a citizen of high motives and beneficent influence.

John G. McConnell, son of Joseph and Elizabeth Jane (White) McConnell, was born in New York City, January 27, 1873. In his boyhood his father returned to Kingston, Ontario, and there he attended the public schools, leaving that place when fifteen years of age and proceeding to Rochester, New York. He was here identified in business with Sibley, Lindsay & Curr, and A. S. Mann, one year afterward moving to Scranton, Pennsylvania, and becoming connected with Clelland, Simpson & Taylor. His first position was as salesman on the retail floor, after which he succeeded H. C. Wallace in the wholesale department, a short time later, when twenty years of age, assuming the management of the entire store, filling this position with able satisfaction for seven years. At the expiration of this time Mr. McConnell made his entry into business independently, establishing at No. 402 Lackawanna avenue, a site now occupied by the Lackawanna Trust Company. Five years later he located at his present place of business, No. 427 Lackawanna avenue, making women's ready to wear garments his specialty, his store carrying the most complete line of such apparel and equalling in accommodations and capacity for trade any emporium of a similar nature throughout the state. Mr. McConnell has been not so entirely absorbed in the upbuilding of his present flourishing trade that all else has been excluded from his daily life, but in the numerous trade movements aiming at better condition and relations of business he has been an enthusiastic worker. He has for many years been a member of the Scranton Board of Trade; was one of the organizers and first president of the Commercial Association, one of the most powerful of Scranton's business men's organizations; and is a member of the Boosters' Club, which is now in the process of organization.

Prominent as has been Mr. McConnell's position in the mercantile world of the city, his standing in that line of Scranton life has been equalled by his conspicuous connection with every project having as its goal the uplift of the standard of civic morality and the promotion of righteousness, and of these may be mentioned, "The Boy Scouts," of which he is one of the council. He has long been identified with the Elm Park Methodist Episcopal Church, and has been the leader of the largest Bible classes, mixed and men's, that have ever congregated in the city. His testimony carries the more weight because those whom he teaches have the realization that in the practice of the principles that he expounds he has risen to the highest level of public esteem; that he does not advocate impracticalities; that he teaches possibilities after accomplishment; and that his words are deep sincerities spoken in love for his fellows.

In national issues Mr. McConnell adheres to the Republican party. He is a member of the Press and Temple clubs, and holds the thirty-second degree in the Masonic Order, belonging to Green Ridge Lodge, Free and Accepted Masons; Lackawanna Chapter, Royal Arch Masons; Scranton Council, Royal and Select Masters; Melita Commandery, Knights Templar; and Keystone Consistory, also holding membership in Irem Temple, Ancient Arabic Order Nobles of the Mystic Shrine. His other fraternal order is the Benevolent and Protective Order of Elks. In these organizations Mr. McConnell finds congenial intercourse with his fellows, while he and his wife are socially prominent in Scranton.

Mr. McConnell married Sally M., daughter of Samuel and Rosanna Seward, her father for many years superintendent of construction for the Lackawanna Coal and Iron Company. They are the parents of Ruth S., Florence E., Rosanna, Edith Evelyn.

## SAMUEL N. CALLENDER

The history of the Callender family dates back to before the Revolutionary War period, in which one of its members actively participated, and in the various communities in which the family have resided they have taken an active and prominent part, wielding an influence for good.

(I) The ancestry of Samuel N. Callender on the paternal side is traced to Samuel Callender, a resident of Virginia, whose son, Samuel (2) Callender, was born in that state, and who served as a Revolutionary soldier, attached to the personal guard of General Washington; after the conclusion of hostilities he went to Connecticut, where he married the sister of an old comrade, and later moved to New York state, and from there to the state of Pennsylvania, being among the pioneers. His son, Samuel (3) Callender, born in New York state, removed with his parents to Pennsylvania, the locality in which they settled being known as "Callender's Corners," now Green Grove. Two sons of the family remained in Green Grove, but Samuel removed to Blakely, Pennsylvania, and there married Elizabeth London, daughter of a pioneer family. He purchased and cleared up a farm, and in due course of time became prosperous, being among the prominent men of the community. He served as deacon of the church, and a Baptist Memorial Chapel was erected in his memory. The maternal ancestry of Samuel N. Callender dates to Captain Daniel Kelley, an officer of the Revolution, who after that war ended settled in Wilkes-Barre, Pennsylvania.

(II) Rev. Newell Callender, son of Samuel (3) Callender, was born at Blakely Center, Pennsylvania, February 27, 1821, died August 13, 1911, aged ninety years. He received an excellent education, and began his active career as teacher in a public school and was also an instructor in music. Later he was ordained to the ministry of the Baptist church, continuing active ministerial work for many years. He was a strong temperance worker and identified with the Washingtonian movement of many years ago. He married Harriet Ferris, born in Blakely, Pennsylvania, April 11, 1823, died in 1902. Seven of the ten children of Rev. Newell Callender are living at the present time (1914) and of these Samuel N. is the second eldest.

(III) Samuel N. Callender was born in Blakely, Pennsylvania, February 28, 1847. He attended public school in Blakely until eight years of age, when the family moved to Wayne county, Pennsylvania, where he also attended school, and later the family returned to Luzerne (now Lackawanna) county. At the age of seventeen he enlisted in the Second Regiment Pennsylvania Heavy Artillery, mustered in March 8, 1864, honorably discharged and mustered out January 29, 1866. He returned to Blakely where he established a mercantile business which he continued until 1888. He then rented his store and opened an office in Scranton for the transaction of the insurance and real estate business, in which he was then and is now successfully engaged. About 1898 he moved his residence to Scranton and now resides at No. 414 Quincy avenue. Mr. Callender is a member of Immanuel Baptist Church, and in political faith is a Progressive, known as the Washington party in Pennsylvania. He is also a member of the Grand Army of the Republic, past commander of W. W. Watters Post, No. 414, at Olyphant, senior vice-commander of Lieutenant Ezra Griffin Post, No. 139, at Scranton, in 1913, also served as chief of staff of the Department of Pennsylvania under State Commander Captain P. DeLacy.

Mr. Callender married Margaret J. Jones, daughter of Edward Jones, of Blakely, Pennsylvania. Children: Mabel C.; Grace H.; Edward J., died aged twenty-four years; Jessie, married Edward A. Harmes, of Great Bend, Penn-

sylvania; Clarence N., who is a member of the law firm of Graham & Callender, Philadelphia, Pennsylvania; Margaret; Gordon S.

---

### JAMES J. O'MALLEY

Born and reared in the Lackawanna Valley, Mr. O'Malley has by force of character and assiduous attention to his profession gained a leading position among her sons. He is a grandson of Michael and a son of Michael D. O'Malley, both born in Ireland, as was his mother.

James J. O'Malley, son of Michael and Annie O'Malley, was born in Olyphant, Lackawanna county, Pennsylvania, November 27, 1870. He was educated in the public schools of that borough and in The School of the Lackawanna, at Scranton. He began business life as a telegraph operator at Olyphant, later prepared for the legal profession, and was admitted to the Lackawanna county bar, February 22, 1896. He has practiced in Scranton continuously since his admission and has a large and influential clientele. He has been admitted to all state and federal courts of the district, his practice extending to all. In 1900 he was the Democratic candidate for district attorney and is the present attorney for the Olyphant Bank. He served two terms on the school board of his native borough, and in all things is the public-spirited and progressive citizen. He has confined himself closely to his practice, but has outside interests of importance, holding, among other positions, a directorship on the Olyphant Bank board. He is a member of the Roman Catholic church and of the Heptasophs.

Mr. O'Malley married, November 28, 1901, Margaret Murphy, born in Scranton, daughter of Michael and Anna Murphy, the former a foreman for the Scranton Gas and Water Company, holding that position at the time the mains were first laid in Scranton. The following children have been born to Mr. and Mrs. Murphy: Thomas P., Michael (2), James Philip, William, Nellie, Mira, Dorothy M., married George Palmer; Margaret, married James J. O'Malley. Children of Mr. and Mrs. O'Malley: Girard, Russell, Willard, Robert, Margaret, Anna.

---

### JAMES B. SCHRIEVER

Probably no science has offered a wider expanse for exploration and unique discovery than photography. In the appliances invented, methods devised and processes discovered, a new art has been given to the world, an art of fact, not of fancy, beautiful with the beauty of nature, not of the imagination, a portrayer of things as they are, not as they might be. A leader in the revolution that has brought all this to pass, one of the most active workers for perfect photography, and a successful artist in every branch of his profession is James B. Schriever.

He is a son of German parents, his father, Jacob Schriever, having been born in Berlin, Germany, in 1814, whence he came to Baltimore, Maryland, later moving to Emporium, Pennsylvania. In the latter place he engaged in wholesale grocery dealing, and was so busy at the time of his death in 1877. He married Veronica Schmond. They had: Maria, Elizabeth, Gertrude, James B., of whom further; Julia.

James B. Schriever was born in Brookville, Jefferson county, Pennsylvania, April 30, 1868. His education was obtained in the public schools and completed by a course in a business college, after which, at the age of nineteen years, he entered the photograph business in Kane, Pennsylvania, later moving to Emporium, in the same state, where he still conducted his operations, and

in which place he married. In 1900 he came to Scranton and opened a studio at No. 110 Wyoming avenue, where he has continued to the present time, and conducts a business far in advance of any of a like nature in this city. In the equipment of this studio nothing has been left undone to make it the most complete possible. This, combined with Mr. Schriever's artistic ability, has drawn to him a well merited class of trade from the best people of the city. The negatives he has been able to make under the conditions include nearly every person of prominence in the city of Scranton, and also those in the surrounding country, and the reputation which he enjoys justly places him at the head of his profession in Northeastern Pennsylvania.

Mr. Schriever has not confined his interests and works in photography to his studio, but has compiled and published a complete photographic encyclopedia of ten volumes, endorsed and approved by testimonials from the government and from universities. The only practical work on every thing photographic ever published. Realizing that associations are one of the best means for the dissemination of knowledge and information in any line of endeavor, he has ever supported such institutions as would advance his art, and is at the present time (1914) president of the Professional Photographers Society of Pennsylvania, members thereof representing three states, Pennsylvania, Maryland, Delaware, and the District of Columbia. In March, 1913, this organization numbered sixty-six members, and while only a beginning was of little practical value. Since Mr. Schriever became connected with it new life has been infused into its arteries, and largely through his efforts the membership has been increased until the total list numbers over eight hundred. Through this association he has probably done more to further the higher possibilities of photography than any other exponent of the art in this locality, and has begun to make possible great achievements in the way of public exhibitions and other demonstrations of like nature. That he is striving in a good cause, and that there is a wonderful future for advanced photography is shown by its introduction into many educational institutions and other organizations of a social and instructive nature. In the coalition of photographers and a sympathetic union for the common good lies the true hope of the most potent results, while in the education of the public tastes will the seed of future popularity be planted. It is along both these lines that Mr. Schriever has been active, and although his relation with such movements covers a period of but fourteen years, in that time he has accomplished much of real value and perpetual effect. Besides holding membership in several social organizations and in those whose members are restricted to those of his profession, he belongs to the Business Men's Commercial Association.

Mr. Schriever married, at Emporium, Pennsylvania, Katie, daughter of Charles Zarps. Mr. and Mrs. Schriever are the parents of one daughter, Irene.

---

#### WILLIS A. KEMMERER

When in 1910 the Bittenbender Hardware Company was incorporated there appeared the name of Willis A. Kemmerer as vice-president. This marked the remarkable rise of Mr. Kemmerer during his then eighteen years' connection with the firm, he having begun as office boy in 1892, reaching the vice-presidency in 1910, and so continues at the present time, 1914.

He is a grandson of William Kemmerer, a farmer near Stroudsburg, Pennsylvania, who had children, John M., Jacob E., Joseph, Mary, Elizabeth, Jennie. John M. Kemmerer was born near Stroudsburg, Pennsylvania, in 1846, and during his early life was a farmer. When twenty-one years of age, in 1867, he came to Scranton where he engaged in the grocery business and was

a resident until his death in 1908. He married Marilla, daughter of Jacob E. Bittenbender, who bore him: Willis A., Joseph, Jake, Charles, Jerome, Peter, Frank, Kate, Mary, Ida, Ella, Anna.

Willis A. Kemmerer was born in Scranton, Pennsylvania, March 21, 1872. He was educated in public and private schools of the city, and at the age of twenty years entered the employ of the Bittenbender Hardware Company of Scranton, beginning at the foot of the ladder. He rose steadily in position, and when the firm was incorporated in 1910 he was chosen vice-president. He is thorough master of his business and has been one of the strong factors in the upbuilding of the business. He has fairly won his present position, and has gained at the same time the respect and confidence of his business associates. He is a member of Union Lodge, Free and Accepted Masons; Lackawanna Chapter, Royal Arch Masons; Coeur de Lion Commandery, Knights Templar; Keystone Consistory, Ancient Accepted Scottish Rite, Thirty-second Degree, and a Noble of Irem Temple, Nobles of the Mystic Shrine, the latter body of Wilkes-Barre, the others all of Scranton. He has other fraternal relations, notably, the Heptasophs and the Scranton Engineers' Association. He attends the First Presbyterian Church. In political faith he is a Republican. Mr. Kemmerer, married Mary A., daughter of William Scott, of Binghamton, New York.

---

#### ALLAN LAWRENCE

Bearing a name honored in American history, Mr. Lawrence has in his own right earned a place in the annals of his adopted city, Scranton. He is one of the well known musicians of the city, and during his twenty-two years as leader of the orchestra of Elm Park Methodist Episcopal Church and his twenty years leadership of Lawrence's Band and Orchestra, he became thoroughly well known and appreciated among music-loving people, whom he has entertained and instructed.

(I) He descends from the Connecticut Lawrence family, is a son of Milton and a grandson of John Lawrence, the latter born in New York state in 1808. He was a blacksmith, and in 1830 moved to Bethany, Pennsylvania, where he followed his trade until death. He married, June 26, 1829, Marie E. Stoat, and had issue: Horatio N., now living at Elk Lake, Pennsylvania; Milton, of whom further; Harriet, deceased.

(II) Milton Lawrence, son of John and Marie E. (Stoat) Lawrence, was born in 1835, died in May, 1912. He learned the blacksmith's trade with his father and followed it during his active years. He married Charlotte, daughter of Abraham and Julia Brink, of Syracuse, New York. Children: Allan, of whom further; Daisy, married Wallace Hacker.

(III) Allan Lawrence, only son of Milton and Charlotte (Brink) Lawrence, was born in Bethany, Pennsylvania, August 23, 1864. He attended the public schools of Bethany and Honesdale, finishing in the high school at the latter town. His father, a capable musician, taught him instrumental music to the extent of his ability, then he studied under private teachers, finishing with musical courses at Saginaw and Grand Rapids, Michigan. When he came to Scranton in 1891, he was a finished musician and soon attracted the attention of music lovers. He was employed for two years in the music store of J. W. Guernsey and there formed a wide acquaintance. In 1892 he was chosen leader of the orchestra connected with Elm Park Methodist Episcopal Church and in 1894 organized the band and orchestra that bears his name. He is also a composer, a popular conductor, and the services of band and orchestra under his leadership are in constant demand. There are few occasions

of note where their appearance is not one of the features and not only is this true in Scranton, but in a wide extent of territory. Mr. Lawrence is a member of Lodge and Consistory, holding the thirty-second degree, Ancient Accepted Scottish Rite; is a noble of Irem Temple; member of the Benevolent and Protective Order of Elks; Scranton Press Association; the German Alliance; the Episcopal church, and is chief musician of the Thirteenth Regiment Band Pennsylvania National Guard. In political faith he is a Republican.

Mr. Lawrence married, February 8, 1888, Louisa, daughter of David Manning, of Bethany, and has children: Isabel, born May 22, 1893; Karl, January 30, 1900; Harriet, May 25, 1901; Gertrude, July, 1902.

---

#### THOMAS J. PRICE

Thomas J. Price, alderman of the Thirteenth Ward of Scranton, is a descendant of Welsh ancestry, Wales having been the birth-place of his father, David Price. As a young man, the elder Price came to the United States and became an employee of the Delaware, Lackawanna & Western Coal Company in Lackawanna county, holding, at his death, the position of a fire boss. David Price held membership in the Independent Order of Odd Fellows. He married and was the father of Mary, Elizabeth, William, Thomas J., of whom further, Matilda, John.

Thomas J. Price was born in Minersville, Pennsylvania, November 27, 1856. When he was twelve years of age he came to Scranton with his parents and until he was seventeen was employed in the coal mines. At that age he renounced the miners' life and learned the barber's trade, following that occupation for thirteen years, during most of which time he used his evenings for study, obtaining through his own efforts a generous education. He entered political life as deputy sheriff under Frank Clemmons and Frank Becker, and on July 12, 1909, was appointed alderman from the Thirteenth Ward by Governor Stuart, the appointment being confirmed by election in the spring of the following year. Mr. Price has been an efficient and faithful servant, capably filling the positions to which he has been elected. His fraternal relations are with the Masonic Order and the Royal Arcanum. He married, in 1880, Margaret, daughter of Professor Robert Jones, of Scranton. Children: Palmer, born in Scranton, Pennsylvania, in 1881; Olive J., married F. G. Hamilton. The Price home is at No. 1311 Capouse avenue.

---

#### CHARLES S. SEAMANS

Descendant of English ancestors who were among the disciples of Roger Williams in the founding of the first settlement of Rhode Island, Providence, the Seamans were residents of that state until the founding of the line in Pennsylvania, when John Seamans, a native of Rhode Island, settled in Factoryville, Pennsylvania. The maternal grandfather of Charles S. Seamans was William Green, likewise a native of Rhode Island, who came to Pennsylvania in young manhood and became a pioneer farmer of Benton township, Lackawanna (then Luzerne) county, where the mother of Charles S. Seamans was born.

(II) Hon. John M. Seamans, son of John Seamans, was born in Factoryville, Pennsylvania, and for more than forty years engaged in the mercantile business at Wallsville, Pennsylvania. He attained a prominence in business life that soon won him recognition as available material for public service, and in 1887 he was elected to represent the seventh district of Luzerne county (now the third district of Lackawanna county) in the state legislature. His



*Thos. J. Coice*





action as a member of this body did not disappoint those who had persuaded him to announce his candidacy, and his share in the legislation that was enacted during his tenure of office was one to which no shame could be attached, and on the contrary, reflected happily upon the maturity and soundness of his judgment. In the midst of exciting debate or sharp party contest he ever maintained his mental poise, striving to see none of the trivial issues but ever the ultimate good of the commonwealth.

(III) Charles S. Seamans, son of the Hon. John M. Seamans, was born in Benton township, Lackawanna (then Luzerne) county, Pennsylvania, February 3, 1856. He was reared in Wallsville, Pennsylvania, where his father was engaged in business, and was educated in the district school of that locality and at Keystone Academy, Factoryville, Pennsylvania. In November, 1881, he established in the grocery business, his store being at No. 317 Penn avenue, and for eighteen years he successfully conducted a retail trade of generous dimensions. Ever since taking up his residence in Scranton Mr. Seamans has manifested a genuine and active interest in all phases of city life, and has always been a sincere worker for its betterment and advancement. This interest found expression in a manner that redounded decidedly to the benefit of Scranton during the seven years in which he was secretary of the Scranton Board of Trade, when besides securing the city several important industries he strove indirectly to raise its standard and to increase its attractions. He was elected to the common council for a two years' term and staunchly supported all measures that appealed to him as being designed only with the city's welfare at heart, and himself fathered the fender ordinance, relating to the equipment of the rolling stock of local traction companies, which was adopted and is in effect at the present day, a most worthy measure in safeguarding the Scranton public. Mr. Seamans' present business activities are largely confined to Sprague & Henwood, an incorporated company, the Eureka Specialty Printing Company, and the Scranton Savings and Dime Bank. In the officary of the two first named concerns he holds the position of vice-president, while of the latter he has been a director for a period covering twenty years. His fraternal society is the Masonic Order and he is a past master of Union Lodge, No. 291, F. and A. M., a charter member and first master of Green Ridge Lodge, No. 597, past high priest of Lackawanna Chapter, Royal Arch Masons, and past commander of Melita Commandery, No. 68, K. T.

Mr. Seamans married, at Wilkes-Barre, Pennsylvania, Emma A., daughter of Peter Raeder, an early inhabitant of that city. The Seamans' home is at No. 1528 Wyoming avenue.

---

### JAMES B. DOYLE

A merchant of West Scranton of more than thirty years' standing, James B. Doyle has there achieved material success and prosperity in his line, hardware dealing, in which he has been engaged independently for the past ten years, his present location being at No. 212 North Main avenue. He is a native of county Westmeath, province of Leinster, Ireland, son of Michael and Anna (Bray) Doyle, his father having died in the homeland. Children of Michael and Anna (Bray) Doyle: Christopher, deceased; Thomas, lives in British Columbia, Canada; Michael, a resident of New York City; John, resides in Scranton; James B., of whom further.

James B. Doyle, son of Michael and Anna (Bray) Doyle, was born May 13, 1854. He was educated in the public schools of his native land, coming to the United States when a youth of seventeen years, entering the machine

shops of the Delaware, Lackawanna & Western Railroad. After a short term of employment in these shops he was for three and one-half years apprenticed to the plumber's and tinner's trade with C. H. and W. G. Dowd, spending some time thereafter in New York City and some time in the vicinity of Scranton. In 1882 he returned to Scranton, whither he had come immediately upon landing in this country, and established in hardware dealing, in partnership with C. A. Foss, also conducting plumbing and tinning operations, his place of business being at No. 224 North Main street, and later their location was changed to No. 124 North Main avenue, where it remained until 1902 when Mr. Doyle bought the property at No. 212 North Main avenue, there building the large store which his business now occupies, and at which advantageous place he conducts a generous and lucrative business. His partnership was dissolved in 1893 and since that time he has continued his business alone. His trade is probably the largest of its nature in West Scranton, for with all outward conditions of the best, such as favorable location and attractive store, the excellent stock of standard materials carried and the uniformly careful consideration tendered each patron causes the most desired impression to remain with each customer visiting the store. Mr. Doyle is a member of the Scranton Board of Trade, the Master Plumbers' Association, and the Master Tinner's Association. He affiliates with the Democratic party, and belongs to St. Patrick's Roman Catholic Church. Mr. Doyle married, in 1898, Anna Wymb's, of Scranton.

---

#### JOHN E. ROCHE

As a member of the Scranton council and as representative of that district in the Pennsylvania legislature, John E. Roche has performed services of signal value to his community. In other branches of the city's activities and in all things that pertain to the conduct of a good and loyal citizen his part has been as nobly borne and as capably executed. He was born on June 12, 1850, at Cecilstown, county Cork, Ireland, eldest son of Cornelius and Mary (O'Connor) Roche. In the year of his birth his parents immigrated to Canada and it was there, in the Province of Ontario, that his youth was spent. He obtained a meagre education in a school at a Mohawk settlement, near Deseronto, most of his classmates being Mohawk Indians. In perception and intelligence he was far superior to his aboriginal comrades, and his ambitious spirit chafed under the slow advance made necessary. He did not, however, confine his study to school hours, but read a prodigious amount of the best of literature. Throughout his entire life he has pursued this course and, though he has never been within the confines of college walls, he has acquired a vast and diversified fund of general and accurate information and culture that has served him well, enabling him to come into contact with men of academic learning far in advance of the ordinary individual and feel no loss of prestige or embarrassment because of imperfect scholastic attainments. In 1860 his parents moved to Pennsylvania settling near Middle Valley, Wayne county, where his father, he lending boyish assistance, cleared a place in the wilderness to erect a home. Three years later they moved to Hawley and here Mr. Roche engaged in various kinds of labor, picking slate on the coal docks, driving mules on the Delaware and Hudson Canal, peeling bark, cutting lumber, and finally acting in the capacity of brakeman on the Pennsylvania Coal Company's Gravity Railroad, until 1872, when he came to Scranton, his present home. He engaged in the grocery and provision business in 1876 and as a merchant of the city became well known to a large proportion of its inhabitants. Six years later he was compelled to retire, owing to failing

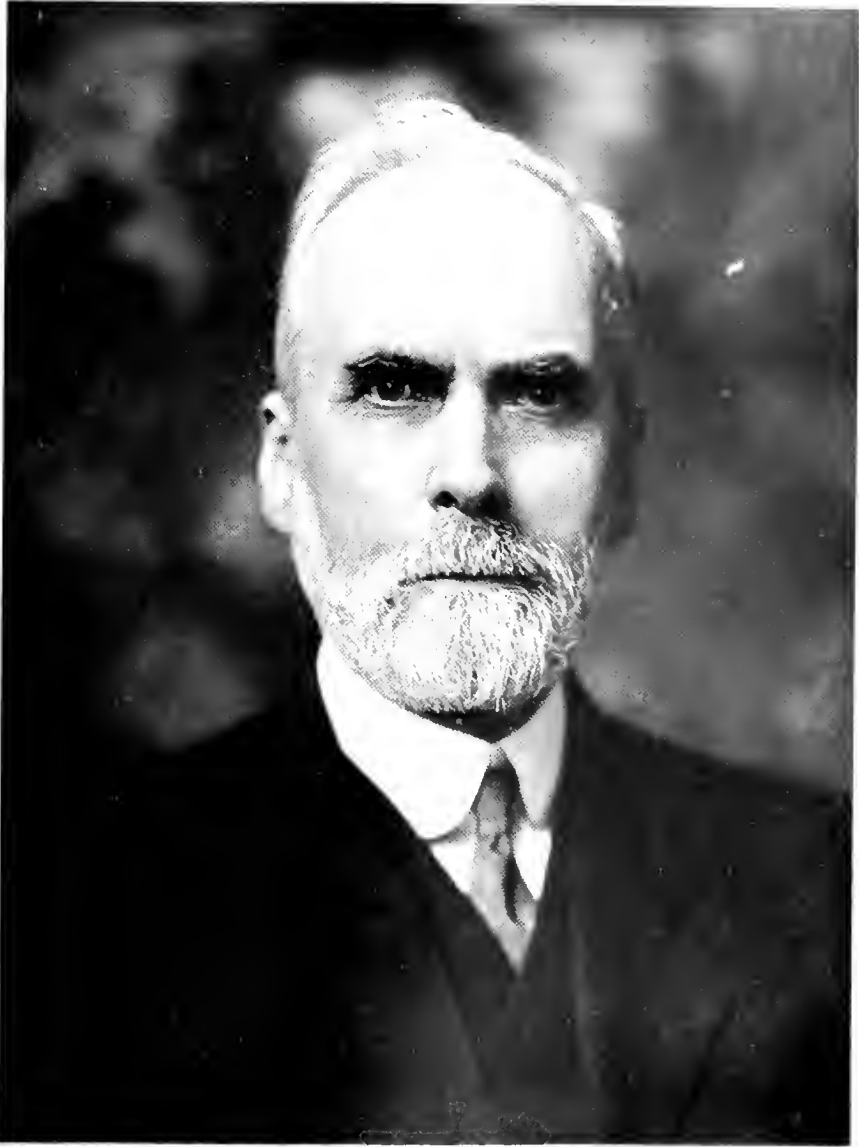

*Gov. E. Roche*



health, and in that year was the Democratic nominee for assembly, being elected to represent the city from 1883-1884 inclusive. He immediately entered into the affairs of that body with enthusiastic energy and was an ardent supporter of the ballot reform bill and the appropriation bill for the Lackawanna State Hospital, at Scranton, for whose support and maintenance the legislature appropriated \$40,000, the largest amount ever granted by the state to any public institution of Northeastern Pennsylvania up to that time. With his past record so strongly in his favor, in 1884 he was a candidate for re-election, but owing to the large Democratic defection to James G. Blaine, presidential candidate for that year, he was defeated, as was all the rest of the ticket. After the inauguration of President Grover Cleveland he received an appointment as cashier of the Scranton post office, but in February 1889, resigned that position to become the local representative of a wholesale hardware and mine supply house, known as the Hunt & Connell Company, a position he held until January 1, 1901. This house went out of business at this time; but in 1899 the stockholders had disagreed and the business was placed in the hands of three trustees of which Mr. Roche was one. He held this position and gave his undivided attention to the business conducting it so successfully that when it was closed up the trustees received three dollars for every dollar they had invested in the business. In 1892 he began his connection with local politics as a member of the Scranton select council, and in 1896 was re-elected without opposition. On several occasions he was the candidate of his party for the presidency of that body. While a member of the council he was the principal promoter of many municipal improvements, among them the Linden street and Roaring brook bridges, both substantial and beautiful structures, erected at an aggregate cost of \$275,000. His wise foresight and energetic promotion have achieved for the city many needed improvements, that have tended toward its transformation from a mere manufacturing centre to one of residential use as well, because of the activity of the city administrations in raising the municipal standard. For several years he was a member of the Democratic county committee, being chairman of that body in 1894-1895, was for two years a member of the Democratic state central committee of Pennsylvania, was a delegate to several state conventions, and was acting delegate to the national convention of 1896, at which W. J. Bryan was nominated. These attest his prominence in the political matters of the day outside of his city and demonstrate the confidence placed in his judgment and deliberative ability, as it is in the gatherings above mentioned that the party policy is formed and a line of action determined upon. When the city of Scranton was added to those of the second class he was the unsuccessful candidate for mayor against Captain Mair. It was evidently the opinion of Captain Mair that Mr. Roche was too valuable a man to be outside of the administration and immediately after Captain Mair's inauguration he appointed Mr. Roche director of public works, and while in this office Mr. Roche did much of the work in laying and building Nay Aug Park. So conscientiously and so ably did he officiate in this capacity and so many were the benefits accruing from his well directed efforts that upon his retirement from the office he was lauded by the press, commended by the administration, and congratulated by his wide circle of friends. Among his other public acts he was the promoter of the viaduct on West Lackawanna avenue, and one of the principal promoters of the opening of Wyoming avenue. Since then he has been again elected councilman and held that office until it was abolished.

In his business pursuits Mr. Roche has been no less successful than in his public and political life. For a time he was manager of the business of A. J. and P. J. Casey, and at present is manager of the Wilkes-Barre branch

of the wholesale flour and grain business of C. P. Matthews & Sons (Incorporated). In the organization of the Pine Brook Bank and at the first meeting of its directorate he was elected vice-president; still serving the institution as the incumbent of that office, he has declined the presidency of this bank, although urged to accept it. In May, 1908, he was appointed receiver of the New Equitable Building and Loan Association, of Scranton, and continues to discharge the duties of the receivership.

Soon after Mr. Roche's arrival in Scranton he affiliated with the Father Matthew Abstinence Society, and, becoming interested in the movement, gave to it his hearty support. He was one of the foremost organizers of the Catholic Total Abstinence Union of the diocese of Scranton, and in compliment to his useful services was elected its first president. The magnitude of the work was not apparent at the time of its inception, but the fact that the union now numbers ten thousand members proves that its founders builded better than they knew, and they built strongly, firmly, and well, else on their foundation could never have been raised the splendid superstructure that the years have brought forth. He is also a member and has been the president of the St. Vincent de Paul Society of the Cathedral parish and has always taken an active part in this and all church matters. To summarize the life of Mr. Roche it can only be said that in his wake have followed the love of friends, the gratitude of his city, and praise for faithful service, nobly conceived and masterfully executed.

John E. Roche married, May 27, 1877, Mary L. Campbell, of Carbondale, daughter of Henry Campbell, an engineer. His wife died January 3, 1912. A daughter, Mary Louise, died in infancy. They adopted by law, two daughters, at ten months and five months of age, now (1914) twenty and eighteen years of age, Genevieve and Esther.

---

#### WILLIAM THOMAS HACKETT

The history of this branch of the Hackett family begins in the United States with Richard Miller Hackett, who came in early life, finally settling in Carbon county, Pennsylvania, where his son, William T. Hackett, was born. Richard M. Hackett was born in Warwickshire, England, in March 1807, died in 1885 at Scranton, Pennsylvania. He became an expert miner, being for many years, and at time of his death, a mine foreman in the employ of the Delaware, Lackawanna & Western Railroad Company. He was a member of the Episcopal church and a man of strong character. He married Susan Cooper, also of English parentage, who died in 1895, aged eighty-six years. Children: Hannah H., married Casper Weissenflue; Sarah H., married Colonel E. H. Ripple; William Thomas.

William Thomas Hackett, only son of Richard Miller and Susan (Cooper) Hackett, was born at Buck Mountain, Carbon county, Pennsylvania, July 26, 1851. He attended public schools until fifteen years of age, then began business life as office boy for the Lackawanna Iron and Steel Company. He continued his business life as clerk in the employ of Coursen Hitchcock & Company for one year, then became clerk in the purchasing department of the Delaware, Lackawanna & Western Railroad, following with a short period as bookkeeper for L. B. Powell. He later returned to the employ of the Delaware, Lackawanna & Western, entering the coal department offices as clerk. After a satisfactory term of general clerical service he was promoted to the position of private clerk to William F. Halstead, general manager of the road. Finally leaving the railroad service he became chief accountant for the Stowers Packing Company, continuing until 1883. In the latter year he became cashier

of the Scranton Republican, continuing three years. In 1888 he established a real estate and fire insurance business in Scranton in which he is still successfully engaged. He has during this period been connected with many important real estate activities that tended to promote the prosperity and improvement of his city, also with enterprises that have proven advantageous to his community. He was one of the charter members of Grace Reformed Episcopal Church, was chosen a member of the first vestry of which he has been continuously a member. He has for many years been interested in the Young Men's Christian Association, is a director of the Scranton branch and present recording secretary of the board. He is an active member of the Board of Trade and useful in the operations of that body in promoting Scranton's welfare. In political faith Mr. Hackett is a Progressive.

Mr. Hackett married Mary M., daughter of George and Amanda Mayer, of Scranton, Pennsylvania, her father a leading merchant of that city. Children: Mary, married Dr. W. H. Philip, of Cape May; Emily, a violinist of high reputation.

---

### DAVID SPRUKS

Not only as the proprietor of one of the largest wholesale grocery houses in the city of Scranton is David Spruks known to the business world of the city, but likewise as an officer of several companies engaged in the working of the natural resources of the region.

(I) The family of which David Spruks is a member is of German origin, John Spruks being the first of the name to leave the homeland and to embark upon a career in the United States. He settled near St. Louis, Missouri, where he pursued agricultural operations until his death.

(II) John (2) Spruks, son of John (1) Spruks, was born in Germany in 1824, and came to the United States when about eighteen years of age. He was a carpenter by trade, and as he gradually acquired sufficient capital he branched out into contracting, in which he met with more than moderate success. He was a tireless worker and in his unflagging energy lay the secret of his success. He died in August, 1903, aged seventy-nine years. He married Hannah Fenne, a native of Germany. Children: Thomas, deceased; Josephine, married ——— Huber, of Scranton; John, deceased; Henry J., a resident of Scranton; Stephen S., lives in Scranton; Annie, married ——— Huber, of Scranton; Bertha, married ——— Muller; Dena, deceased; David, of whom further; Charles, of Scranton.

(III) David Spruks, son of John (2) Spruks, was born in Wayne county, Pennsylvania, August 21, 1860. Although never possessed of the opportunity to attend college, he obtained a thorough education in the public schools of his birth-place and in the high school at West Brighton, Staten Island, New York, also in the academy at Beech Lake. For four years he taught school in Wayne county, Pennsylvania, and from 1882 until 1888 he was engaged in business at Honesdale, coming to Scranton in the latter year, and identifying himself permanently with that city. Soon after his arrival he began in the wholesale grocery business at No. 23 Lackawanna avenue, and, as in the growth of his business larger quarters became necessary, he erected a fine structure at the corner of Spruce street and Lackawanna avenue, the present home of his business. In this line, the first in which he engaged in Scranton, he has established a reputation for fairness and honor in all dealings, and has prospered in large measure. His other business connections are with the Scranton Tobacco Company, of which he was an organizer and of which he is president, a position he has held since the first election of the board of di-

rectors; the Scranton Cold Storage Company, of which he is president; the Bulls Head Coal Company, whose treasurer he has been since 1906; the Bright Coal Company, of which he was made treasurer in 1909, still holding these offices; and the Scranton Savings and Dime Bank, of which he is director and secretary. Mr. Spruks' wise counsel and sound advice are large factors in the control of these organizations, his experience in business matters and his safe and conservative judgment making him a valuable advisor. He is a member of the Masonic order, and in political issues supports the Democratic party. He married Ada, a daughter of George Baties, of Philadelphia.

---

#### MAXWELL CHAPMAN

The career of Maxwell Chapman that has led up to his successful establishment in business in the city of Scranton is one that holds a story of professional achievement, of attainment, and of commissions efficiently executed, the recital filled, not only with interesting narration, but, upon closer reading, an example of an opportunity profitably seized. He is the third of his family in direct line to follow engineering professions, his grandfather, Isaac A. Chapman, having in 1822 built the first railroad from Summit Hill to Slack Water Navigation at Mauch Chunk, and was the first civil engineer to undertake the problem of slack water navigation on the Lehigh river.

(II) Charles I. A. Chapman, son of Isaac A. Chapman, was born in Wilkes-Barre, Pennsylvania; and after graduation from Lafayette College and the Philadelphia Law School, was admitted to practice at the Luzerne county bar. The wearing nature of his profession and its confinement telling upon his health, he withdrew from legal associations and turned to civil engineering, being employed by the Pennsylvania Coal Company in the construction of the gravity railroad from Pittston to Hawley, later entering the state service on the North Branch canal. He married Martha S. Blanchard, and had children: Maxwell, of whom further; Blanchard; May Elizabeth, married William Dean, of Wilkes-Barre, Pennsylvania.

(III) Maxwell Chapman, son of Charles I. A. and Martha S. (Blanchard) Chapman, was born at Port Blanchard, Pennsylvania, January 1, 1856. His preparatory education was obtained in the public schools, and his first business experience was as a clerk in the employ of J. H. Swoyer, after which he became a mining engineer with the Lehigh Valley Coal Company, being attached to a corps at Hazleton. The three following years he was on the Second Geological Survey of Pennsylvania, his connection with state work ceasing when the final report of that commission was submitted to the authorities. The Mexican government having granted the concession for the construction of the Mexico National and Central railroads, he made a contract with the Mexican government and went to that country as division engineer, running the first preliminary line from Mexico City to Vera Cruz by way of Jalapa, his connection with the railroad company enduring for two years. At the end of that time he organized the Mequeta Gold and Copper Mining Company in Mexico City, the capital for this enterprise being advanced by Mexico City financiers. It was necessary to send to Chicago for machinery to operate on the property of the company, a ten stamp goldmill, made in Chicago, being shipped to Vera Cruz by water, via New York, from there hauled sixty miles to Jalapa in mule carts and carried down into the mines by Indians. In Rhode Island he engaged a mechanical engineer to assemble the mill, and after the entire plant was in regular operation he was active manager for three years, installing numerous contrivances to facilitate the workings in the different departments, among them a telephone line connecting the mine





Maxwell Chapman



and the mill, a tramway bringing the ore from the first to the latter for milling. He was then engaged by the Mexican Central Railroad to explore the state of Jalisco for coal, and after a year's prospecting came north to Laredo, Texas, and made report of territory rich in the deposits of this mineral, at that time being county surveyor of Grant county, New Mexico. Cattle raising then attracted his notice as a profitable field of endeavor and he purchased a large ranch in the Victoria Valley in New Mexico, at that time being the only settler in the valley. The discovery of water on his property removed the only difficulty that had confronted an enterprise offering otherwise excellent possibilities, and he immediately purchased five hundred head of the best breeding cattle obtainable, later securing Ohio capital and incorporating the Buck Eye Land and Live Stock Company. This concern in 1887 owned six thousand head of cattle, grazing over territory seventy-two square miles in extent, wind mills and steam pumps at convenient locations supplying the stock with water, cattle being shipped to eastern and western markets. Mr. Chapman sold his interest in the live stock company in 1891 and came east in the interest of the Swartzschild and Sulzberger Beef Company, at that time in the thick of conflict with the Chicago beef trust, thus ending his connection with western life as a resident. Part of his work in Grant county, New Mexico, had been the laying-out of the present school districts, and he had built the first six miles of railroad grade south of the international line, on the Mexican Southern Railroad. For eight years he was manager of the business of the Swartzschild and Sulzberger Beef Company in Scranton, selling the first dressed beef in the coal region and erecting three beef houses in their interest. Roosevelt's war on the beef trust introduced conditions whereby an individual possessed as great opportunities in shipping and dealing in beef as those enjoyed by the corporations, and Mr. Chapman, perceiving the advantages open, resigned his position with the corporation employing him and in 1904 established in independent dealing. Journeying to Iowa he there made a personal contract with a small packing-house of reliable reputation and has since conducted his business in Scranton, Forest City, and Wilkes-Barre, his venture being accorded a favorable reception in the regions that he has invaded, the domination of trusts, corporations, and syndicates having become exceedingly irksome to retailers and small dealers. He is also a director of the Lincoln Trust Company, of Scranton.

Political and public affairs have not been omitted from Mr. Chapman's scheme of existence, and as chairman of the county committee of the Progressive party he has been so stalwart a supporter of Progressive principles that he is his party's candidate for state senator. He will carry to the polls the good-will and backing of a wide circle of admirers and friends, whose respect he holds for the fearless and upright manner in which he states his convictions, having the courage with them to stand or fall. His fraternal society is the Masonic order, in which he belongs to lodge, consistory and shrine.

Mr. Chapman married, in 1886, Kate A., daughter of Charles A. Ryon, of Tioga county, Pennsylvania. They are the parents of one son, Charles L., born in New Mexico in 1888, a graduate of State College, at the present time a mining engineer at Big Stone Gap, West Virginia, the fourth of his line to devote his life to engineering.

---

#### JOHN ZIMMER

First as a shoe merchant and later as furniture dealer John Zimmer has been engaged in business independently in the city of Scranton, although prior

to entering these fields he had been employed in different capacities by various firms in the city. His father, John Zimmer, was likewise a merchant of Scranton until his death. John Zimmer was a son of George A. Zimmer, a blacksmith by trade, who came to the United States from Germany, which country had been the family home for many generations. George A. Zimmer was the father of: John, of whom further; Kate, Emma, Nellie, Elizabeth, George, deceased; Jacob.

John Zimmer, son of George A. Zimmer, was born September 5, 1866, met an accidental death, July 4, 1912. His business career was begun in the Greenwood Pottery Works in Trenton, New Jersey, and when he was fifteen years of age he was there employed as a potter and later as a china decorator, after some years becoming associated with the Lehigh Valley Decorating Company as assistant foreman in the china decorating department. In 1896 he was commissioned to open a store for this company at No. 140 North Main avenue, Scranton, and of this store he was manager until the dissolution of the company employing him. This occurred in 1900, in which year he purchased the store of which he had formerly been in charge and continued in business in that place, decorating his wares in a shop of his own and transacting his affairs independently. His patronage increased and his quarters became cramped, so that he moved into a larger and more conveniently planned store. This performance was repeated several times and he finally located permanently at No. 121 North Main Avenue, where he gradually withdrew from china decorating and dealing, in its stead handling furniture, until in time he dealt exclusively in the latter line, in which his former success was duplicated, his new business attaining even greater dimensions than his old. Mr. Zimmer belonged to the Knights of the Maccabees. He married Theresa, daughter of John Pirola, a notary public of Trenton, New Jersey, and had two sons, John, of whom further, and William.

John (2) Zimmer, son of John (1) and Theresa (Pirola) Zimmer, was born in Trenton, New Jersey, March 8, 1889. He obtained his education in the public schools of Allentown and Scranton, Pennsylvania, Keystone Academy, and Pennington Seminary, at Pennington, New Jersey. His studies completed he entered the Star Line Messenger Service, and was then assistant bookkeeper in the employ of the McClave Brooks Company, afterward becoming a surveyor for the Delaware, Lackawanna & Western Railroad Company. His next positions were in a clerical capacity with A. P. Brown and the Young Men's Christian Association, after which he entered the journalistic field as advertising representative of the New York World, later becoming a member of the reportorial staff of the Hudson County Observer, of Hoboken, New Jersey. In 1912, in partnership with L. Fred Hayes, of Newark, New Jersey, Mr. Zimmer began shoe dealing in the city of Scranton, a relation which was discontinued upon the death of his father when he became the head of the business formerly conducted by the elder Mr. Zimmer. In the two years that have passed since that time he has enlarged his place of business, making improvements to the value of fifteen thousand dollars, and has so increased its breadth and scope that he is the proprietor of one of the most extensive furniture businesses in West Scranton, from which he realizes a generous revenue. Mr. Zimmer is a charter member and the first president of the Ad-Crafters' Association of New York City, holds independent political opinions, and attends the Washburn Street Presbyterian Church.

Mr. Zimmer married, November 12, 1912, Esther Louise, daughter of Leopold Lutz, and they have one son, John Jr., born January 24, 1914.

## JAMES B. GARVEY, M. D.

There is no truer index to the impression made by a man's life than the breadth of grief felt when he is called from this to his eternal home. Truly, then, was the life of Dr. James B. Garvey one in which each of his many natures was allowed full play, for from the children who were his devoted friends to his bereaved family many were the classes and manners of people to whom his death came as a distinct and personal loss. His friends reached from the Atlantic to the Pacific, and the inspiration of his manly, Christian life, the nobility of his splendid spirit and courage, will endure even though he, in the flesh, has departed to claim his fairly-won reward.

To trace the career of Dr. James B. Garvey is to follow a most unusual line, for while it was in the medical profession that he was pre-eminently noted, he did not enter that field until he had started himself well upon the highway to prominence and success in educational fields. He was a son of Michael and Catherine (Boylan) Garvey, the parents of five children, three of whom survive: Right Rev. Eugene A., of Altoona, Pennsylvania; Catherine, who married Timothy Curtin; Mary A., who married Patrick J. Horan.

Dr. James B. Garvey was born in Carbondale, Lackawanna county, Pennsylvania, November 5, 1843, his parents making their home in Dunmore, Pennsylvania, from the time he was seven years of age. He here attended the public schools, and continued his studies in St. Mary's College, of Wilmington, Delaware. When a young man of twenty years he journeyed to California, and became a school teacher in Calaveras county, his efforts in that place being so cordially received that he was elected county superintendent of schools, an office he filled with signal ability for two terms. Remaining in that part of the country, he was subsequently elected to the sheriff's office, and for four years held this position upon the executive branch of the county government, his administration a satisfactory one in every respect. In 1878 the confidence reposed in him by his fellows was evidenced by his election to the state constitutional convention, and in this body he represented Calaveras county, serving on the legislative committee of which General Terry was chairman. Two years afterward Mr. Garvey returned east, beginning the study of medicine in the Baltimore College of Physicians and Surgeons, receiving his M. D. from that institution in 1884, and then returning for one year of post-graduate work. Active work in his profession, begun in Dunmore, Pennsylvania, was here continued until his death, which occurred August 23, 1914, and few physicians are there who may boast of a prouder record or a professional career that has adhered more closely to the highest ideals and traditions of medical practitioners. While gaining prominence in the medical world he also gained the regard and favor of all whom he met, whether in a social, business or professional capacity, and it is especially significant of his tender sympathy and all-embracing good fellowship that his most loyal and devoted friends were the children of the neighborhood in which he resided.

During the seventy-one years of his life he gradually accumulated a library in which he took a natural pride and great comfort. Herein he had gathered, besides his professional works, the masterpieces of the world's literature, with which he was as familiar as with old friends, as, indeed, the volumes were. From a well-stored mind he drew upon solid information in conversation, and his pleasant manner made his fluent speech the delight of those privileged to know him intimately. In reasoning temperate, in judgment calm, and in outlook upon life well balanced and clear, he filled his career to overflowing with acts of usefulness, kindness and charity, so living that his death caused a void that can be bridged, but never filled.

Dr. Garvey married, August 31, 1881, Mary A., daughter of Judge Thomas Collins, of Luzerne county, Pennsylvania, and sister of Hon. Frank D. Collins, of whom further. Mrs. Garvey was formerly a school teacher, a woman of education, culture and refinement. She is the mother of two sons: Dr. Frank C., of Scranton, and Eugene A., of Buffalo. Dr. Garvey was buried from St. Mary's Church, of Dunmore, Pennsylvania, his brother, Right Rev. Eugene A. Garvey, being the celebrant at the solemn high mass of requiem which was held on the day of his burial.

Judge Thomas Collins was born in Ireland, June 24, 1811. He came to the United States in 1839 and located in Ulster county, New York. In 1845 he removed to Wilkes-Barre, Pennsylvania, where he secured a position as hammer man in the iron works, and being a powerful man as well as prompt in the discharge of his duties, he soon rose in favor. In 1849, when the Pennsylvania Coal Company began the survey of their railroad between Pittston and Hawley, he took a contract for the construction of two miles of the road, and removed his family to Dunmore where he erected a large store building and conducted an extensive mercantile business until 1851, when his property was destroyed by fire sustaining a heavy loss. Nothing daunted he rebuilt and continued business until 1866, when he was elected associate judge of Luzerne county, a position he filled with credit to himself and to the satisfaction of his constituents. About a year prior to his death he was stricken with paralysis and died January 9, 1878. His widow, Catharine (Dolan) Collins, and two children, Hon. Frank D. Collins and Mary A. Collins, survived him.

Hon. Frank D. Collins, son of Judge Thomas and Catharine (Dolan) Collins, was born in Saugerties, Ulster county, New York, March 5, 1841. In early boyhood his parents removed to Dunmore, Pennsylvania, and his education was acquired at St. Joseph's School, Susquehanna county, Pennsylvania, and Wyoming Seminary. He began the study of law in the year 1866, and three years later was elected district attorney of Scranton. In 1872 he was elected state senator; in 1874 was elected to Congress from the eleventh district known as the "Shoestring District," embracing the counties of Monroe, Pike, Carbon, Columbia, Northumberland and a part of Luzerne. He was re-elected in 1876, representing his district in the forty-fourth and forty-fifth Congresses. He continued the practice of law in Scranton until he was called to his final rest, November 21, 1891. He married Mary McNichols, who died about eighteen months prior to his death, leaving two children who found a pleasant home with Dr. Garvey and wife.

---

#### MICHAEL J. MURRAY

This is the life story of a poor Irish boy, who at seven years of age came to the United States, began working in a coal mine at the age of twelve years, in middle life was a successful coal operator and now at the age of sixty-seven years is president of the First National Bank of Dunmore, one of the solid and substantial business men of his adopted state. There is more than one useful lesson that may be learned from Mr. Murray's successful life, the greater, perhaps, being his belief in himself. This does not imply that he is engrossed in self or that self importance is a characteristic, for a more modest and retiring man never lived. It does mean that he has a supreme confidence in his own ability to overcome difficulties by perseverance, hard work and good judgment. Utterly unaffected, plain in speech and apparel, tall with shoulders bowed by his years of labor in low roofed mines, big hearted, generous and neighborly, he is the same in manner to-day in his beautiful banking offices as he was, not many years ago, when with pick and drill he wrought in the mines. No story

of sudden riches, luck investment or of fortune's favor can here be told; Mr. Murray's success came after years of toil, after successfully achieving where others feared to venture, and there is no taint upon his wealth. It has been honestly and fairly earned and better still it is being honestly used. No man stands higher in the respect of his fellowmen, nor is there one to cavil at his success. He fought a good fight, played well his part and all honor is his.

Michael J. Murray was born in Ireland, March 10, 1846, son of Peter Murray, who emigrated from Ireland in 1853, settled in Dunmore, Pennsylvania, and there died in 1889. He married Bridget Walsh, who bore him children: Patrick, Mary, John, Michael J., Anthony.

Michael J. Murray was seven years of age when his parents left Ireland and came to Dunmore. He attended school until he was twelve years of age, then began working in the mines. For twenty years he continued a miner, filling all the different positions from breaker boy upward until he was rated a capable miner. He worked in the mines of the Pennsylvania Coal Company and established his own humble home in Dunmore. He lived the life of the average miner, earned a good living for his family, but was ever on the lookout for opportunities to better his condition. He thoroughly understood mines and mining, but having little capital, did not start independent operations until about 1883, when he saw his chance. The Pennsylvania Coal Company had an upper vein of coal that their engineers could not plan to handle profitably, the vein being near the surface and the roof bad. Mr. Murray learned that the company would gladly sell their rights in this vein, deeming it of no value. He believed that there was a great deal more coal in the vein than was supposed, and further believed in his ability to work it safely and profitably. He formed a partnership with his brother, Anthony J. Murray, Thomas Brown and John Carney, secured a ten years' lease from the Throop and Parker estates and on the strength of his lease and his demonstration of its value obtained a loan of \$20,000, and began operations in a small way. They met with discouragements in plenty during the early operations and at times failure seemed sure. To less determined men than the Murray Brothers failure would have followed, but they had faith in the mine, faith in themselves, and each discouragement but nerved them to greater efforts. At last the day broke and the black night of doubt and gloom was dispelled. The small plant was enlarged, and a breaker with a daily capacity of 350 tons erected. All the expectations of Mr. Murray were realized, and in eighteen months the borrowed \$20,000 was repaid and capital began accumulating in the bank. Prosperity continued, more coal area was leased and operations continued until October, 1905, when Messrs. Brown and Carney purchased the interest of the Murray Brothers, paying them, therefore, in cash \$152,000. With his half of the amount, M. J. Murray purchased and leased 464 acres of coal land at Bernice, Sullivan county, Pennsylvania. He then organized the Northern Anthracite Coal Company which operates the mines, which proved valuable and very profitable from the very beginning. Mr. Murray was the first president of the company and continues its capable and efficient head. He has other important business interests and continues as ever, the earnest worker.

Mr. Murray was for some years a director of the Fidelity, Deposit and Discount Bank of Dunmore, but resigned upon the organization of the First National Bank of Dunmore, of which he was elected president. This bank opened for business, November 1, 1910, in its own building at Dunmore, "Four Corners," its opening being marked with conspicuous success. Ten thousand people are estimated to have visited the beautiful building during the day and two thousand depositors were entered on the books of the bank, their deposits amounting to \$144,000. The bank has since the opening day

steadily advanced in public favor and in material prosperity. This record covers a half a century of the business life of Mr. Murray from breaker boy to bank president. View him as you will, he is one of the remarkable men of a remarkable age, and has won distinction in a community of strong men, not weaklings. The doctrine of the "survival of the fittest" prevails in the coal region perhaps with greater force than anywhere else—hence the only inference is that Mr. Murray is a "strong" man in every sense of the word.

Mr. Murray married (first) Bridget Carney, who died in 1875, the mother of ten children; those living are: Peter J., general manager of the Northern Anthracite Coal Company; Lydia, a graduate from Providence Hospital, District of Columbia; Bridget, married James McDade; Michael J., a lawyer; Loretta, wife of W. J. Dooley; Agnes, a sister of the Immaculate Conception, connected with the Convent of the Immaculate Conception. Mr. Murray married (second) Bridget McAndrew; children: Anthony, a graduate of Bucknell University, now a law student of the University of Pennsylvania; Catherine, a teacher; Elizabeth, now Mrs. E. Mongan; Margaret. One of the features of the furnishing of the First National Bank Building is an oil painting of the president, Michael J. Murray, a gift to the bank from the children above enumerated, in honor of their father.

---

#### MICHAEL J. MURRAY JR.

A son of Michael J. Murray, president of the First National Bank of Dunmore, and grandson of Peter Murray, the founder of this branch of the Murray family in the United States, Michael J. Murray Jr. has achieved prominence in his community in his own right. The settlement of his forbears in Dunmore, Pennsylvania, dates from 1853, and in the more than half century of residence, no name has become more favorably or better known.

Michael J. (2) Murray, son of Michael J. (1) Murray and his first wife, Bridget (Carney) Murray, was born in Dunmore, Pennsylvania, January 20, 1878. His youth was spent in acquiring a public school education, and after passing through the Dunmore schools he took a full course at Stroudsburg State Normal School, there fitting himself for the profession of teacher. After his graduation from Normal School he taught for two years in the Dunmore schools, first as assistant and second as principal. He then decided to prepare for the legal profession and entered the law department of the University of Pennsylvania. He was graduated LL. B., class of 1902, and in the same year was admitted to the Lackawanna county bar, beginning practice the same year. He was in due season admitted to the state and federal courts of the district and is now well established in practice. In October, 1904, he was appointed justice of the peace to fill a vacancy, and at the election in 1905 was duly elected for a full term. In February, 1910, he was re-elected and is yet in office. He is also attorney for the Dunmore School District; attorney for the First National Bank of Dunmore; attorney for and a director of the Northern Anthracite Coal Company, of Murray, Sullivan county, Pennsylvania. He is a member of the State and County Bar associations, and is highly regarded by his professional brethren. Although one of the younger members of the Lackawanna bar, he has won distinction as a learned and able lawyer, and one in whom all confidence may safely be placed.

He married, in 1904, Alice M., daughter of James and Cecelia Gilmartin. Children: Clare, born August 20, 1906; Agnes, November 28, 1907; Alice, July 30, 1911; James Francis, November 9, 1912.







A. E. Roggen

## ADELBERT E. ROGERS

Although a native born Pennsylvanian, Mr. Rogers spent a part of his early life in Binghamton, New York, and there learned the trade and business he now is engaged in at Scranton. He is the son of George W. Rogers, born in Wayne county, Pennsylvania, in 1833, died in 1887. He was a conductor on the Delaware, Lackawanna & Western Railroad and during his long term of service resided in Scranton, Pennsylvania, Binghamton, New York, Honesdale, Pennsylvania, and Waymart, Pennsylvania. He married Eliza Harris, of Honesdale, who survived him twenty-four years dying in 1911. Children: Alvadora, Theodore, Adelbert E., of whom further, and William W.

Adelbert E. Rogers, son of George W. and Eliza (Harris) Rogers, was born in Waymart, Pennsylvania, December 12, 1862. He was educated in the public schools of Scranton and of Binghamton, New York, finishing his studies in the high school of the latter city. He there became a jeweler's apprentice and thoroughly mastered the watchmaker's trade. He continued work at his trade in Binghamton until 1885, when he located in Scranton, working for C. W. Freeman until 1889, when he started in business for himself. He built up a good business along conventional jewelers' lines, continuing until 1911, when the corporation, A. E. Rogers Company, was formed with Adelbert E. Rogers, president, E. M. Rogers, vice-president, J. W. McAurie, secretary and treasurer. The firm is well known to the trade as manufacturing jewelers and silversmiths, located at No. 425 Lackawanna avenue. Mr. Rogers is thoroughly practical in his knowledge of the jewelry business in its manufacturing, wholesale and retail branches and conducts the large business of his company with judgment and success. He is a member of Union Lodge, No. 291, Scranton, F. and A. M., holds the thirty-second degree in Scottish Rite Masonry and is a Noble of the Mystic Shrine.

He married, in 1893, Eva M., daughter of Dr. H. M. Kelly, of Nicholson, Pennsylvania. Children: Florence E., born May 28, 1894; Geraldine K., born May 12, 1896; Grace M., born March 17, 1898.

---

 GEORGE C. BROWN, M. D.

Scion of a New England family and a native of the state of New York, George C. Brown, of this chronicle, has achieved prominence and honorable position in the medical profession and for more than twenty years has given of his services to the Dunmore community, where he is held in general liking and universal high regard. He is a grandson of Asa Brown, born in Vermont, April 25, 1795. He was a farmer in calling and moved with his family to Wyoming county, New York, where he resided until his death, August 8, 1860. He married Susan Mosher, born in Vermont, August 24, 1782, died October 6, 1881, both being buried in Wyoming county, New York.

Milton R. Brown, son of Asa and Susan (Mosher) Brown, was born in Vermont, December 29, 1824, died in Gainesville, New York, April 3, 1900. He moved with his parents to New York, and in that state engaged in the publishing business, also owning and operating a farm. He married Caroline Hardin, born in New York state, September 8, 1824, died in Philadelphia, Pennsylvania, May 21, 1883, while in search of relief from the poor health from which she had suffered. They were the parents of five sons and three daughters.

Dr. George C. Brown, son of Milton R. and Caroline (Hardin) Brown, was born in Wethersfield, Wyoming county, New York, April 23, 1858, and was there reared. He attended the Gainesville and the Pike seminaries, obtain-

ing his professional education in the University of Pennsylvania, at Philadelphia, whence he was graduated in the class of 1880. After making a European tour he was for four months ship's physician in the employ of the Red Star Steamship Company, serving on vessels on the transatlantic passenger trade. He then entered upon the practice of his profession in Gainesville, New York, and was there located for ten years, spending the two following years in Avoca, Pennsylvania, and then moved to Dunmore, Pennsylvania, in which place he is now a successful practitioner. Outside of a large general practice, Mr. Brown serves as medical examiner for numerous insurance companies, and holds membership in the County, State, and American Medical associations, at one time having held the office of district censor for several years. He holds membership in the Royal Arcanum, and in political action is a Democrat.

As a physician Dr Brown stands in the front rank of his profession, and during his Dunmore residence has become a worthy member of that calling in the borough. In private and professional life his actions are directed by a lofty sense of honor, and the generous instincts of his nature have caused him to give liberally of his professional services to those in need. A wide circle of friends testify to his many agreeable and lovable traits of character.

He married Florence Rowland, born in Pike county, Pennsylvania, daughter of George Rowland, who moved from Syracuse, New York, to Pike county, Pennsylvania, in young manhood, and was at different times a representative to the Pennsylvania Legislature from Pike county.

---

#### JUDGE JAMES J. O'NEILL

For five years a judge of the court of common pleas in the Scranton district, the capable manner in which James J. O'Neill has filled the judicial position to which he was elected in 1909 has brought him into prominent notice as a jurist of fine and discriminating judgment and as a student of the law who has delved deep into his subject, his earnest study productive of a knowledge wide and certain. Temperate reasoning and integrity incorruptible complete his full qualifications for his high office, in which under his present ten-year term he remains until 1919. The presidency of such a judge has given to the attorneys appearing before Judge O'Neill assurance and confidence that merit and soundly based legal argument alone will avail, and to litigants that justice and the right will be unflinchingly upheld.

Judge James J. O'Neill, son of Hugh and Ann (Henry) O'Neill, was born in Carbondale, Lackawanna county, Pennsylvania, April 27, 1854. He was reared in the place of his birth, there attending the public schools, completing his education in an institution maintained by the Christian Brothers in New York. Subsequently he became a student at law in the office of Judge P. P. Smith, of Honesdale, and in 1882 was admitted to the bar of Wayne county, two years later gaining entrance to the bar of Lackawanna county. While building up a large private practice he was assistant district attorney under Judge Kelly, and at the same time became prominent in political matters, for several years serving as chairman of the Democratic county committee. He served two years as mayor of Carbondale, and was city solicitor of that city for one term. In 1900 he was the Democratic candidate for the judgeship he now occupies, and has served half of a ten-year term. Judge O'Neill is a lawyer of established reputation, and the high legal ability and wise perspicacity he has displayed while upon the bench has given added lustre to the fame achieved as an advocate.

Judge James J. O'Neill is a member of the Sportsmen of America, the Knights of Columbus, and the Catholic Mutual Benefit Association. His club is the Scranton, and he is a communicant of St. Rose Roman Catholic Church.





*F. S. Benedict*

## LEONARD G. REDDING, M. D.

A physician of five years' standing, Leonard G. Redding, M. D., of Dunmore, Pennsylvania, has in that brief period attained a position in his profession that is at once worthy and responsible, one to the arduous duties of which he ably measures up and in which he has gained favorable recognition.

Dr. Leonard G. Redding is the only child of William and Catherine (Conroy) Redding, and was born on Jefferson avenue, Scranton, Pennsylvania, July 27, 1885. His public school education was obtained in the public institutions of Dunmore, Pennsylvania, after which he became a student in St. Thomas' College, the medical profession then attracting him to its study. Matriculating in Medico-Chirurgical College, of Philadelphia, he was graduated therefrom in the class of 1908, passing the following year in the Scranton State Hospital, and in 1909 began general practice in Dunmore. There he continues to the present time, having been elected a member of the local board of health, caring for the needs of the large clientele that he has gradually acquired, living a busy and useful professional life. For the past three years he has been on the staff of the Scranton State Hospital, the institution with which he was formerly connected, and during 1913-1914 served as chairman of the public policy committee of Lackawanna county. The County, State and American Medical associations held his name upon their rolls, and thus, as in numerous other ways, he keeps in touch with the newest developments in his ever advancing, ever changing calling. His church is St. Mary's Roman Catholic, and he is an adherent to Republican principles. Dr. Redding's home is at No. 106 Blakely street, Dunmore, Pennsylvania, where he lives with his widowed mother.

---

REV. JOHN J. RUDDY

In Rev. John J. Ruddy the priesthood of the Roman Catholic church has a member who for nearly four decades has devoted his life to the service of the church. He is a native of Pennsylvania, has made that state the field of his labors and has produced therefrom wonderful fruits for Christianity and his church. He was born in Hawley, Wayne county, Pennsylvania, November 24, 1850, and was reared in Scranton. Educated for the ministry of the Roman Catholic church, he was ordained in 1877. From that time until the present the story of his life is one of continuous service, first for twenty years in the western part of Pennsylvania, and since 1899 in Scranton, Hyde Park, Ashley, Parson and Dunmore, in which last-named place he is now located. His pastorates have all been successful ones, marked by an increase in spiritual and material welfare in the congregations to which he has ministered, and in his service in Dunmore a past of achievement leads to a future of promise, to be fulfilled under his leadership.

---

FRANK S. BENEDICT

Sufficient time will never elapse for those who knew Frank S. Benedict to forget the manliness of his character and the purity of the motives that filled his life. To few men it is given to hold so universally the respect and regard of so large a number of friends during life, and to the memory of a smaller number is accorded the reverent love that follows him even after his departure from his daily path. At his death he was past the allotted three score years and ten, and for twenty-five years had lived retired from the mercantile operations that had filled his active years and in which he achieved success and

fortune. His disposition was sunshiny, and his cheerfulness and humor so infective as to brighten the lives of those with whom he came in contact. Unselfish, he was always considerate of the feelings of others. He was noted for his sterling integrity and his whole life was noble.

Of old Massachusetts, New England, stock, Frank S. Benedict was born at Starrucca, Wayne county, Pennsylvania, February 6, 1836, died February 9, 1913. He was the son of David Benedict, who came from Massachusetts, and who died in April, 1875, aged seventy-five years, and Sarah Benedict, who died August 6, 1871, aged sixty-four years, and of a family of eight children: Nelson M.; Truman; Ruth, widow of Nelson Callendar; Frank S.; Albert H.; Delia, widow of Samuel Clark; Mira, widow of Columbus H. Hubbard; Olive, wife of T. K. Laidler. Frank S. Benedict is survived by one brother, Albert H., of Green Grove, Pennsylvania, and two sisters, Olive, wife of T. K. Laidler, of Tunkhannock, Pennsylvania, and Mira Hubbard, of Scranton, widow of Columbus H. Hubbard. Frank S. Benedict was reared in the county of his birth, and in boyhood was a student in the village school, later attending Madison University. He afterwards went to Poughkeepsie, New York, studied under Professor Stoddard, and graduated from one of the best business colleges in the land. Then becoming a clerk in Major Strong's mercantile establishment, he was so employed until the beginning of active warfare between the North and South, when he enlisted August 5, 1861, in Company F, First Regiment of Light Artillery, recruited in Wayne county, Pennsylvania. Prior to the battle of Antietam he was raised to the rank of corporal, and in that conflict received a severe wound in the hand, as a result of which he was for several months confined in the hospital, subsequently receiving honorable discharge from the service. Returning from the front, he came to Scranton, then followed an active mercantile life at Green Grove near Scranton, during which time he was also postmaster, a combination of duties frequently found in rural districts. He then retired from trade, took a trip through the west, and for about ten years resided at Clarks Green, Pennsylvania, whence he moved to Scranton where he remained for twelve years, afterwards making his home at No. 1712 Madison avenue. During the last quarter of his life he purchased a considerable amount of property in Scranton, Dunmore and vicinity. Fraternally Mr. Benedict was a member of the Masonic Order and the Independent Order of Odd Fellows. In religion he and his family were regular attendants of the Methodist Episcopal church, Mr. Benedict participating in the services as choir leader, for which position a strong and musical voice well fitted him. Music was his delight, and in its enjoyment he and his friends spent many happy hours. He was a logical thinker and careful reader; and as he was a staunch supporter of the right and naturally refined his influence was always ennobling and helpful. Temperance ruled his life in word and action as well as in matters of physical import. His political party was the Republican. As a sportsman he was an enthusiast in hunting and fishing, and took advantage whenever opportunity offered for recreation.

Mr. Benedict married Katherine Smith, born in Green Grove, Pennsylvania, daughter of Valentine and Eliza (Fellers) Smith, and had one daughter, Cora Mae, a graduate of the Scranton High and Training Schools, having taken a special course in music and art and specialized in vocal culture at Wyoming Seminary, and for two and one-half years a teacher in Scranton Public School, No. 27; married H. Earle Morgan, a government employee in the Scranton post office, and has two sons, Frank Benedict and Robert Earle. Her home is with her mother at No. 1712 Madison avenue.

Born of Christian parents, in youth Mr. Benedict dedicated his life to God.



The teachings of His Holy Word he followed in precept and example all the days of his life. The Sabbath day always found him in church, weighing the thought of the sermon and assisting in singing or leading the choir. He attended Sabbath school and for many years was Sunday school superintendent. His home influence was ideal and his loss is keenly felt. He loved his home and family devotedly and was a most thoughtful and tender husband and father. As he was ever of a kind and jovial disposition and optimistic in all his views of life, his genial nature won for him a host of friends. Broad-minded, even-tempered at all times and deeply sympathetic, he was an interesting conversationalist and companion. It was his desire to serve others, and he was the special friend of the struggling and deserving young man, the counsellor and confidant of many such. He is gone! Yes, but he still lives; his friends will never forget the sweetness of his disposition. Kindness and good cheer radiated from his spirit as perennially as sunshine and warmth radiate from the orb of day. His faith was in the Son of God, and he abides with those who have washed their robes and made them white in the blood of the Lamb.

---

#### MARION D. SNYDER, M. D.

One of the two sons of David N. Snyder who have chosen the medical profession as the field of their careers, Dr. Marion D. Snyder, of Dunmore, Pennsylvania, has in the seventeen years that have elapsed since his entrance into that calling achieved worthy position and made an honorable record.

David N. Snyder was born in Scott township, Lackawanna county, Pennsylvania, and there passed his early life, the beginning of the Civil War finding him a soldier in the volunteer ranks of the Union. He served throughout the four years of the war, and although his company was numerously engaged and saw some severe fighting, he was neither wounded nor taken prisoner during that time. After the war he made his home in Susquehanna county, Pennsylvania, and there his wife, Mary J. Snyder (not a relative) died, aged forty-five years. Mr. Snyder owned land one mile east of Dundaff, Pennsylvania, and there since resided. He is a member of the Baptist church, as was also his wife. David N. Snyder is a loyal Republican in political sympathy and action, having been elected to several local offices as the candidate of that party, and is also a member of the Grand Army of the Republic and the Masonic Order. David N. and Mary J. (Snyder) Snyder were the parents of five children, their eldest child, a daughter, dying in infancy. Those who attained mature age are: Abram E., a physician of New Milford, Susquehanna county, Pennsylvania; Ella M., a trained nurse, educated for her profession in the New York Training School; Myrtle B., now deceased, was a trained nurse of New York City, married Charles Marvin, an attorney of New York City; Marion D., of whom further.

Dr. Marion D. Snyder, youngest of the five children of David N. and Mary J. (Snyder) Snyder, was born in Susquehanna county, Pennsylvania, May 27, 1870. After obtaining an elementary and preparatory education in the public schools and Keystone Academy he entered Jefferson Medical College, of Philadelphia, whence he was graduated in 1896. January 1, of the following year, found him established in the practice of his profession in Dunmore, Pennsylvania, where he has since been located. His work has been general in character and he has frequently found his surgical training of use and benefit, while the passing years have steadily raised him to positions of greater influence among his professional brethren. He is recognized as a physician of upright and manly attributes, a thorough master of his profession, and those

whom he serves in a professional capacity place in him the most absolute trust and confidence. Dr. Snyder is medical examiner for the local Brotherhood of Railroad Engineers and Firemen, the Mutual Life Insurance Company, also serving numerous other organizations in a similar capacity. He is a member of the Lackawanna County Medical Association.

Dr. Snyder married Kathryn Birdsall, a native of Susquehanna county, Pennsylvania, daughter of William Birdsall, and they have two children, Marion David and Gordon.

---

#### EDWARD W. OSTERHOUT

For many years one of the representative business men of Scranton and vicinity, and one who made his influence felt in business circles and many other lines, was the late Edward W. Osterhout. He was born June 9, 1864, in Nicholson, Pennsylvania, died June 20, 1912, buried in Dunmore Cemetery.

He was brought by his parents to Dunmore, aged seven years, where he grew up, and after finishing the course in the public schools of the place he attended Eastman's Business College, at Poughkeepsie, New York, leaving that institution in 1884 with the foundations well laid for beginning a business career. At first he was associated with his father in the building, contracting and lumber business and the business through his initiative and energy became imbued with new strength and vigor; the firm of W. D. Osterhout & Son which continued as such up to 1905, the year of death of the elder Mr. Osterhout, was in the forefront of firms of its line, second to none in point of excellence of workmanship and satisfaction to its patrons. Edward W. Osterhout had fraternal connections with King Solomon Lodge, No. 584, F. and A. M., of Dunmore; K. of P., Lodge No. 167, and while in business was also a member of the Builders' Exchange of Scranton, Pennsylvania. Mr. Osterhout was an ardent believer in the principles and policies of the Democratic party, but in no sense a politician, finding that he could best express his opinion at the ballot box in favor of those candidates who in his best judgment ministered to the public good and not bosses with only personal ends and aims in view.

Edward W. Osterhout married, September 15, 1885, Mary E. Herold, daughter of Charles and Ann M. (Finkler) Herold, of North Main avenue, Scranton. Children: 1. Cora, born June, 1887, died at the age of two and a half years. 2. William J., born February 13, 1890; educated at Dunmore school, and is now engaged as a printer at I. C. S.; past chancellor of Dunmore Lodge, No. 167, K. of P., and member of Camp No. 795, P. O. S. of A., Petersburg. 3. Ralph E., born February 28, 1893; educated at Dunmore school; now engaged in the operation of a private auto garage; member of Dunmore Lodge, No. 167, K. of P., and Junior Order United American Mechanics. 4. and 5. Twins, Beth and Ruth, born August 30, 1894; at home. 6. Helen, born August 21, 1896; at home. The family home is at No. 159 East Grove street, Dunmore, where Mrs. Osterhout is favorably known for the generous hospitality which she extends to all who come within the circle of her acquaintance. She is a member of the Eastern Star, Martha Washington Chapter, No. 3, and also attends the Methodist Episcopal church.

---

#### FRANCIS LEO MURPHY, M. D.

A graduate of the Dunmore High School, educated for the medical profession in a southern university, Dr. Francis Leo Murphy is one of the latest additions to Dunmore's competent corps of medical men, and has before him

every prospect for a life of professional usefulness and good. His ancestry is Irish, his father, John C. Murphy, having been born in Ireland, and after immigrating to the United States became a jobber. He married Mary McMunn, of Carbondale, Pennsylvania, and had seven children, four sons and three daughters.

Dr. Francis Leo Murphy, youngest of the seven children of John C. and Mary (McMunn) Murphy, was born in Dunmore, Pennsylvania, May 20, 1890. He received his scholastic training in the public schools of that place, graduating from the high school in the class of 1909. Strongly attracted to the medical profession he entered the medical department of Georgetown University, at Washington, District of Columbia, completing his course in that institution in 1913. Since that time he has been engaged in practice in the borough of his birth, and is now connected with the State Hospital at Scranton. He is examiner for Erie Railroad, Brotherhood of Trainmen, and Protected Home Circle. He is a member of Washington Council, Washington, D. C., Knights of Columbus, and the Phi Beta Phi fraternity, to which he was elected while at Georgetown University. His church is St. Mary's Roman Catholic.

---

### JOHN J. GILLIGAN

The arrival of the year 1914 ushered from the office of burgess of the borough of Dunmore, Pennsylvania, John J. Gilligan, the incumbent of that office since March 1, 1909. Born in Dunmore, he has ever since lived in that borough, and has there built up a business in fire insurance and real estate dealing, a business founded on the same trustworthiness and stability of character that placed him in the office of chief executive and that has given him prominent position in local affairs.

He is of Irish descent, his father, John Gilligan, born in Ireland. He was there reared and educated, in young manhood coming to the United States, where he married. His occupation was that of miner, and he was so employed throughout his active years, dying aged seventy-one years. He was a Democrat in politics, and with his wife held membership in the Roman Catholic church. He married Anna Cunnion, a native of Scotland, who now resides with her daughter, Mrs. Edward Cawley, at No. 224 West Drinker street, Dunmore, Pennsylvania. They were the parents of six daughters and two sons, all now living with the exception of one daughter.

John J. Gilligan, third child of John and Anna (Cunnion) Gilligan, was born in Dunmore, Lackawanna county, Pennsylvania, July 21, 1877. As a youth he attended the public educational institutions of that place. His first employment was in the coal breaker of the Pennsylvania Coal Company, after which he was for fourteen years a clerk in the general store conducted by F. T. Mongan. In the meantime he had secured an agency for a reliable fire insurance company, and as his dealings in this line increased in volume he devoted his entire time thereto, adding real estate dealing, in which he now continues. He is a member of the Scranton Council, Knights of Columbus, Dunmore Council, Young Men's Institute, Dunmore Lodge, Woodmen of the World, Scranton Lodge, Benevolent and Protective Order of Elks, the Scranton Bicycle Club, the Old Girard Club, of Scranton, the Eclipse Hose Company, and St. Mary's Roman Catholic Church. His political beliefs are Democratic and it was as the candidate of this party that he was elected burgess of Dunmore, in which office he achieved a splendid record. During the course of his administration many municipal improvements were inaugurated and carried to a successful conclusion, among them the laying of pavements

throughout the borough; the signing of a new lease with an electric lighting company with more efficient service at a reduced rate; the equipment of the fire company with a motor truck, the installation of which reduced insurance rates twenty-five per cent.; the organization of adequate police protection; and the completion of the sewer system, which is now the equal of that of any borough of the size of Dunmore. This is but part of the benefits he advocated and secured for the borough through immediate legislation, and Dunmore gratefully remembers an administration productive of so much good.

Mr. Gilligan married Susan M. Kennedy, a native of Binghamton, New York, and had one child, deceased. Their home is at No. 1531 Electric street, Dunmore.

---

#### MARCUS L. DEUBLER

Marcus L. Deubler, a contractor of Scranton, is a descendant of Frederick Deubler, a native of Germany, who upon coming to the United States made his home in Barrett township, Monroe county, Pennsylvania. In this locality he conducted agricultural operations during his active career, and was twice married. By his first marriage he was the father of: 1. Frederick, married a Miss Smith; children: Jane, Charlotte, Emily, Delilah, James, Watson, Frank, Newton. 2. John, married Lydia Mann; children: Ellen, Amy, William, George, Annie. 3. Alexander, married a Miss Rockerfeller; children: Henry and Eliza. 4. Edward, married Hannah Lunnex; children: Charles, Robert, Sophia, Katie, Maud, Mena. 5. George, married and was the father of fourteen children. 6. Christian, married and had children: James, Nathan, Levi, Alfred, Ella. 7. Henry, of whom further. 8. Nathan, a resident of Wisconsin; married and had six children. 9. Catherine, married Nicholas Lisk; children: Lizzie, Ellen, Ida. 10. Lizzie, married Adam Hensler; children: Conrad, Adam, Kate, Lizzie, Maggie. Children of second marriage of Frederick Deubler: 11. Martin. 12. Otto, married and had children: Dora, Rowen, Nelson. 13. Dora.

(II) Henry Deubler, son of the first marriage of Frederick Deubler, was born in Stroudsburg, Pennsylvania, in 1836. He married Loretta Boyer, and had children: 1. Charles W., a farmer and school teacher, married Annie Starner; fifteen children, two of his children deceased. 2. Horace E., a farmer until he attained mature age, then a stenographer, at the present time cashier of the Pine Bush Bank of New York; married Mary Mann; three children. 3. Marcus L., of whom further. 4. Lewis R., died October 15, 1891. 5. Flora C., married Chester Staples; children: Clara, Belle, Ella, Francis, Marvin, Arthur. 6. William K., a contracting builder of Stroudsburg, Pennsylvania, owner of much real estate in that place and a member of the common council. 7. Edward, deceased; married Anna Price. 8. Ida, married Grove Gilpin; one daughter, Etta. 9. Harry, married Jennie Whittaker; two children. 10. Daisy.

(III) Marcus L. Deubler, son of Henry and Loretta (Boyer) Deubler, was born at Factoryville, Pennsylvania, April 22, 1862. Until he was fourteen years of age he was a student in the public schools at Canadensis, then working on his father's farm. After mastering the mason's trade he studied civil engineering under the tutelage of George S. Schafer, at one time surveyor of Monroe county. Upon attaining his majority he began to follow his trade, that of mason, working at all of its branches, stone masonry, brick laying, and plastering, also doing considerable stone cutting. He became superintendent of construction on buildings in New York City, Scranton, Pennsylvania, and Newark, New Jersey, in 1883 being engaged in work on the Vosburg

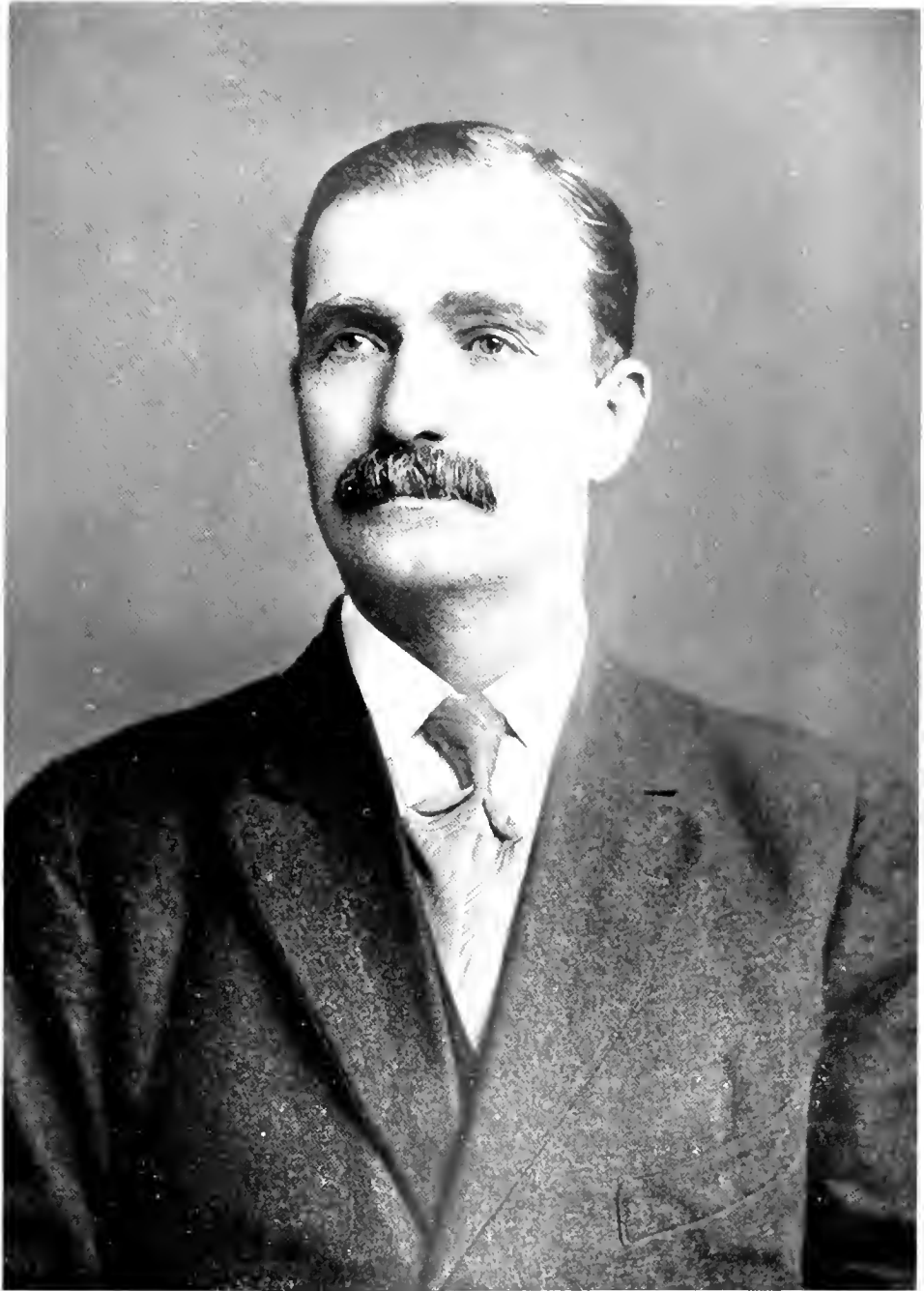

*Marcus L. Deubler*



Tunnel. In 1886 Mr. Deubler moved to Scranton and for three years was there employed; among the numerous buildings upon whose erection he was engaged were the Moses Taylor Hospital and the Lackawanna County Jail, and in 1889 he went to New York. While working on the Prudential Insurance Building in Newark, New Jersey, he formed a connection with Crowell Mundy that endured for four years, and which was followed by three years of association with the Standard Oil Company, at Bayonne, New Jersey. Then, after a four years' relation with Norcross Brothers, of New York City, Mr. Deubler returned to Scranton, where he has since remained. While employed as erecting engineer for Edwin S. Williams, of Scranton, he superintended the building of the State Hospital, the Manual Training School, the building of the Young Men's Christian Association and that of the Railroad Young Men's Christian Association, and the Delaware Water Gap Station, his association with Mr. Williams ending in 1907, when Mr. Deubler established independent contracting operations. Since that time he has erected under his own name some of the finest residences in the city, and has created a favorable impression by the excellent specimens of his work that adorn Scranton. Among these may be mentioned Charles Schrader's residence, one of the finest in the city; rebuilding James Connell's residence, also George H. Catlin's residence and many others. In no way could he have been better fitted for the work he has undertaken and in which he has been so uniformly successful, since his employers have long entrusted all practical arrangements to his wise and experienced judgment. In his work, since in business for himself, Mr. Deubler has secured able assistants, men whose knowledge of the business and whose ability conforms to the high standard he has reared, which is evidenced in the many edifices beautifying the city, erected under his direction.

Mr. Deubler is a member of the Immanuel Baptist Church, an Independent in politics, fraternizes with the Masonic Order and the Independent Order of Odd Fellows, in the former society belonging to Union Lodge, Free and Accepted Masons, and in the latter to Friendship Lodge, No. 11, of New Jersey, and to Providence Encampment.

Mr. Deubler married, in 1885, Linda, daughter of Julius Gorman, of Wayne county, Pennsylvania, and has an adopted daughter, Frances.

---

#### ROY EUGENE COBB

The Electric City Throwing Mills, one of the largest throwing mills of the city of Scranton, is served at the present time by representatives of two generations of the Cobb family. William Jasper, treasurer, and his son, Roy Eugene, secretary and manager. The name Cobb has long been a familiar one in Scranton, the family having early settled in Slocum Hollow from its New York home.

(I) Mount Cobb, Pennsylvania, bears the family name, and in this place Asa Cobb, grandfather of Roy E. Cobb, was minister of the Methodist church nearly all of his life. Asa Cobb married Elizabeth Enslin and they had eight children: Mary Elizabeth, who married W. G. Doud, a well known hardware merchant in Scranton; Ida, a musician; Lillian, a missionary in China, married Henry Ferguson and had four children; Jennie, married George Rozelie, a fruit grower in California; Lulu; Eugene, farmer, in 1867 journeyed to the gold fields of California, and after returning married Adelaide Snyder; John G., farmer and lumberman of Maple Lake, married Frances Wilson, sister of John Wilson, a well known Scranton attorney, and they have two children; William Jasper, of whom further.

(II) William Jasper Cobb, son of Asa Cobb, was born in Mount Cobb,

Pennsylvania, in 1857, and lived on his father's farm until he was seventeen years old. In that time he acquired a good education in the public schools. He supplemented this training with a course in Wyoming Seminary. His first business venture was as a lumberman at Marshwood. For seven years he served as justice of the peace of Jefferson township, Lackawanna county, Pennsylvania. He is a member of the Masonic Order and the Independent Order of Odd Fellows. In March, 1885, he married Harriet Almeda Kizer, daughter of John D. Kizer, a well known lumberman of Kizers, Pennsylvania. This union was blessed with five children: Roy Eugene, of whom further; Grace, Wyoming Seminary graduate; Leila, an accomplished musician; Isabelle, Wilson College graduate and violinist; Willard, still in the grammar schools.

(III) Roy Eugene Cobb, oldest son of William Jasper Cobb, was born at Marshwood, Pennsylvania, January 26, 1886. He studied for a time in the public schools, then went to Bellefonte Academy, and later went to Wyoming Seminary. After completing a business course at Wyoming Seminary, he became secretary of the Ashley Silk Company. Later he was elected manager of that company. When the Electric City Throwing Mills was organized, he was elected secretary-manager of that company. His capable administration of this position is full of promise and future time will record his deeds and accomplishments in the business and industrial world. He is a member of the Second Presbyterian Church. Politically he is affiliated with the Republican party. On April 15, 1914, he married Marguerite Weeks, youngest sister of Ralph E. Weeks.

---

#### EDWIN S. WILLIAMS

As father and son, the name has been intimately connected with large building operations in Scranton ever since 1862, when Jeremiah Williams located in this city, where hardly a street but some building stands as a monument to skill of either father or son. Not only has Edwin S. Williams demonstrated his ability in actual construction, but in the founding of builders' exchanges perhaps no man in this country has been more active or useful. While neither streets nor buildings constitute a city, but its inhabitants, so to the building of this human side of Scranton Mr. Williams has also contributed valuable service. As a citizen he has been allied with the forces of good working through church and social organizations for all that concerns the public welfare.

Jeremiah Williams was born in Northampton county, Pennsylvania, in 1830, died in Scranton in 1892. He spent his early life in Stroudsburg and there learned the mason's trade, beginning contracting when quite a young man and continuing until 1862, when he moved to Scranton. He at once began business as a contractor and builder, continuing in successful operation until his death. In connection with his building operations he had a stone quarry at Nicholson for about eight years and another at West Mountain from which flagging and cut stone was produced. A few of his largest operations were the erection of the Second National Bank, now used as offices by the Scranton Railway Company; the McCann Building on Lackawanna avenue; the Handley Building and several for Richard McHugh, which have since been remodeled; the brick work on the old Penn Avenue Baptist Church, now the Columbia Theatre; the Hunt and Connell Building at the corner of Lackawanna and Wyoming avenues. He also built the Roman Catholic church at Susquehanna and a great many other buildings outside of Scranton. He was not only a reliable builder but a man of straightforward manner and upright life, hold-



ing the esteem and confidence of all who had dealings with him. He was a Republican in politics, a member of the Masonic Order, and attended the Methodist Episcopal church, of which his wife was a member.

He married (first) Mary Diehl, born in Stroudsburg, who bore him three children: Ellen, married C. H. Chandler; Edwin S.; and one who died in childhood. Mrs. Mary Williams died in 1869, aged thirty-seven years. Jeremiah Williams married (second) Mildred Leary, born in Canada by whom he had; Frederick, now of Kansas; George W., now of Schenectady, New York; Bessie.

Edwin S. Williams, only son of Jeremiah and Mary (Diehl) Williams, was born in Stroudsburg, Pennsylvania, October 27, 1862. He attended public school No. 1, in Scranton, until he was fourteen years of age, then entered the business of life by beginning work with his father, then worked in the planing mill of Hull & Parker, receiving as wages twenty-five cents per day. In the morning before going to work he delivered the Times over a route in the city, which increased his weekly earnings considerably. After a year in the planing mill, he began learning the stone cutter's trade, continuing until he was nineteen years of age. He was then placed in charge of his father's stone quarry at Nicholson, but soon after leased a quarry which he operated on his own account, continuing quarrying there and in other places for about ten years. In the meantime he established a cut stone yard in Scranton and later began contracting the stone for buildings and then added building construction. His first large contract was to cut the stone used in the erection of the new County Jail and a little later he furnished the cut stone for the City Hall, erected in 1888. He also obtained the contract to lay the sidewalks around Court House Square, and then began figuring on contracts for an entire building. He secured a number of small contracts, one of the first being the remodeling of N. Morton's store after a fire had partially destroyed it. About the same time he did the mason and steel work on what is now known as the Weeks Building. This was in 1892 and he was yet running his stone yard, in fact, did so until 1898, when he began devoting himself exclusively to the erection of buildings. He has built a number of fine private residences including the Jordan house on North Park, the Barryman and C. P. Matthews residences. The notable public and business buildings he has erected include the Scranton Savings Bank, the Young Men's Christian Association, the Railway Young Men's Christian Association, Immanuel Baptist Church, the State Hospital, Hahnemann Hospital, the brick work on the Karser Valley Shops and on building and round house at Taylor for the Delaware, Lackawanna & Western; depots for the same company at Harrison, New Jersey; Moscow, Clarks Summit, Delaware Water Gap, Bangor, Pennsylvania; Norwich, New York; a round house at Utica, New York; coal pocket at Syracuse, New York, and the brick works on the company shops at Ampere and Kingsland, New Jersey. He did the interior mason work on the Church of the Nativity, Scranton, remodeled the Williams and McAnulty Building for the Globe Warehouse Company, erected public school buildings Nos. 9, 13 and 23, an addition to No. 33, and many others. He bears a high reputation as an honorable and capable builder, and an upright man and a good citizen. He has the courage of his strong convictions, is tenacious of purpose, an untiring worker and fully alive to the responsibilities of life. He early in life embraced the cause of prohibition and has steadfastly maintained that principle. He has suffered himself to be placed at the head of their ticket as candidate for mayor and city controller, not in the expectation or hope of election but to show his devotion to an unpopular cause, in which he firmly believes as the correct and only solution of the liquor problem. For twelve years he was president of the

Builders' Exchange of Scranton and has been instrumental in the organization of many similar bodies in other places. In 1903 he aided in the forming of a State Association of Builders' Exchanges, and in 1907 in forming a National Association of the same. He is a member of Peter Williamson Lodge, Free and Accepted Masons, and of Immanuel Baptist Church, of which he is a deacon. He also served ten years as assistant superintendent and teacher in the Sunday school and two years as superintendent. For nineteen years he was a member of the Vesper Literary Society, three terms its president, and is now president of Vesper League of Immanuel Church. Just now in the full vigor of his manhood, Mr. Williams' opportunities of usefulness are full of promise.

Mr. Williams married Grace H. White, in Plantsville, Connecticut, December 18, 1893. Children: Louise M., Marjorie O., Francis E.

#### CHARLES L. MERCEREAU

For forty years Charles L. Mercereau was active in the business world of Scranton as a jewelry dealer, and for the past eight years he has lived retired in that city. Mr. Mercereau may look back over a career that embodies not only success in business, but which includes two and a half years of service that sounded the greatest depths of patriotism and the firmest foundations of manhood, these being spent in the Union army during the Civil War. He is a descendant of a family of French origin, which was founded in the United States by Huguenot ancestors who fled their native country upon the revocation of the Edict of Nantes. Their first place of refuge was England, but James the Second having just ascended the throne, they feared further persecution, and continued their migration to America. Captain Lawrence Mercereau, an ancestor of the Mr. Mercereau of this sketch, was in Paris at the time of the Massacre of St. Bartholomew, escaped with his family to England, later immigrating to America, where he arrived at the time of the arrival of William Penn. New York became the home of the branch of the family of which Charles L. Mercereau is a member.

(III) John Mercereau, son of Joshua Mercereau, and grandson of Joshua Mercereau, was born on Staten Island, New York, March 2, 1732, died at Union, New York, February 21, 1820. He served with his brother Joshua during the Revolution, the latter being a member of the New York house of assembly from 1777 to 1786. John Mercereau was instrumental in saving the retreat of General Washington's army after crossing the Delaware river, by discovering a sunken boat and destroying it. He drove the post coach from New York to Philadelphia, and at the outbreak of the war turned his horses over to the American army. Upon the conclusion of the war he removed with his family, that of his brother Joshua, and many others, to the wilderness on the banks of the Susquehanna river, and founded the village of Union, New York. September 25, 1804, he wrote a letter from this village to his brother Cornelius, residing on Staten Island, condoling upon the recent death of their brother Jacob. In this letter he copies the record and mentions the old Dutch Bible. The letter is now in the possession of Dr. George B. Mercereau, of New York City. John Mercereau married (first) November 1, 1756, Maria Prawn or Prall, who died in 1770. He married (second) Barbary Van Pelt, born October 19, 1752, died March 10, 1847. Children by first marriage: Maria; Joshua, of further mention; Mary; Abram and John, twins; Allada. Children by second marriage: David, Israel and Peter. John Mercereau was also a brother to David, Mary, Caroline, Paul and Rachel.

(IV) Joshua Mercereau, son of John and Maria (Prawn or Prall) Mer-

cereau, was born on Staten Island, October 4, 1762, died December 4, 1804. He married, December 17, 1784, Keziah Drake, born May 6, 1709-70, died August 2, 1843, and after marriage removed to Union, New York. She was a daughter of Colonel Drake, an officer under General Washington, and a descendant of Sir Francis Drake, the famous English navigator and hero. Children: Jane, married Elias Morse; John D., married Sallie Skillman, and had: Aletta, James S., Joshua, Eliza, Eliza, the second, Sarah Jane, Lydia, Naney, John D., Abby and Hannah; James; Barbary, married Elias Skillman; Mary, married ——— Kernochan; Henry, married Catherine Bartholomew; Joshua, of further mention.

(V) Joshua (2) Mercereau, son of Joshua (1) and Keziah (Drake) Mercereau, was born in Union, New York, September 25, 1804, died July 28, 1882. He was a farmer on an extensive scale, held in high repute in the community in which he lived for the exacting honesty and uprightness that directed his daily life. He was a member of the Presbyterian church. He married, March 20, 1834, Julia Lamonte, born November 8, 1814, died March 26, 1860. Children: James, a brilliant scholar and ministerial student, was born February 14, 1836, died in 1861; Keziah, born February 4, 1838, died in infancy; Charles L., whose name heads this sketch; Caroline L., born September 23, 1842, married Nathan Chandler, deceased; Henry C., born March 7, 1845, married Mary Gumaer; Jane L., born April 6, 1847; Mary, born July 25, 1849, married Wallace W. Duncan; John D., born November 6, 1851, married Geraldine Wagner; Clara, born March 20, 1854, married J. H. Nicholson.

(VI) Charles L. Mercereau, son of Joshua (2) and Julia (Lamonte) Mercereau, was born in Union, New York, May 14, 1840. He attended the public schools there until he was sixteen years of age, finishing his studies in Owego and Athens academies. April 23, 1861, he enlisted in a regiment of volunteer infantry, recruited in Illinois for a short term of service, in the Union army, and was mustered out, August 31, 1861. He then became a clerk in his brother's store, and upon the death of his brother, re-enlisted in the Union army, this time becoming a soldier in a company of Pennsylvania cavalry, which he joined August 23, 1863. In February, 1864, this company and others were united to form the Twenty-second Regiment of Pennsylvania Volunteer Infantry. In May, 1865, the Twenty-second and the Eighteenth regiments of Pennsylvania cavalry were consolidated as the Third Regiment Provisional Pennsylvania Cavalry, which was mustered out of service, October 31, 1865, at which time Mr. Mercereau held the rank of first lieutenant. He was actively engaged in nearly all of the battles of the Shenandoah Valley, and in the engagement at Mount Vernon Forge was taken captive by the Confederate force, and sent to Libby Prison. From this place they were transferred to Salisbury Prison, where almost unbelievable hardships were endured, twelve thousand prisoners dying in this place of confinement within one year. Lieutenant Mercereau was also held prisoner at Danville, Virginia, returning to his home just prior to the evacuation of Richmond.

In 1866 he came to the city of Scranton, establishing himself at once in the jewelry trade, was in this business forty years, retiring from active participation therein in 1906, after having built up a well patronized and flourishing business. He is a member of the Grand Army of the Republic, and has all his life upheld Republican principles. During his residence in Scranton, Mr. Mercereau has formed numerous associations outside of those required by business and, a gentleman of culture and refinement, represents a high type of citizenship.

Mr. Mercereau married Caroline, daughter of William and Caroline Olm-

stead, of Union, New York. Children: Josephine, married Frank Littell, and has: Marion and Charles; Burton, married Hilda Goodman and has one son, Wayne.

---

#### ARTHUR A. WEINSCHENK

The past fourteen years have witnessed the professional labors in the city of Scranton of Arthur A. Weinschenk, who in 1900 opened an architect's office in this city, his training having been received under special instruction in the University of Pennsylvania and in offices in New York City. That space of time has been sufficient for him to gain recognition as a master of his profession, an architect of bold and original ideas, and his work has found favor with his professional brethren and persons of discerning taste, for whose approval he has submitted plans and drawings.

Mr. Weinschenk is a son of Anton Weinschenk, born in Wasser Alfingen, Wittenberg, Germany, July 7, 1829. Anton Weinschenk was educated in the schools of his native land, and there learned the trade of moulder, as a youth of twenty years coming to Pennsylvania and locating in Carbondale, where he was employed at his trade. Two years after his arrival in this place he moved to Slocum Hollow (Scranton) and there entered the service of the Lackawanna Iron and Coal Company. From the rank of moulder, in which capacity he was first engaged, he advanced through various promotions to the position of superintendent of the foundry, filling this important place until his retirement in 1896. He was a trusted employee, vested with full authority in the foundry of the company, and organized an efficient and industrious working force, which he headed in an able manner. Mr. Weinschenk was a musician of no mean talent, and was a member of the Burger Band, later Diller's Band, the first organization of its kind in the city of Scranton. From 1878 to 1886 he was a member of the school board of the city, elected as an independent, faithful in his discharge of the responsibilities and duties such membership carried. His wife was a member of the German Lutheran Church, which the family attended. He was president of the German Building and Loan Association No. 9, having been a member of the boards of directors of associations Nos. 1 to 8, and his son, Arthur A., succeeded him in the presidency of Association No. 8. Anton Weinschenk died in 1905; his wife died in 1909, and both are buried in Dunmore Cemetery.

He married, in 1851, Maria Christman, born in Monroe county, Pennsylvania, November 25, 1834. Children: 1. Elizabeth, married George F. Kellow; a member of the board of aldermen, representing the fourteenth ward; resides in Scranton. 2. Delilah, a teacher in Scranton Public School No. 3. 3. Delphine, married Dr. A. Kolb; resides in Scranton. 4. Arthur A., of whom further.

Arthur A. Weinschenk was born in Scranton, Pennsylvania, June 20, 1871. He obtained his general education in the public schools of this city. After a special course in architecture in the University of Pennsylvania, at Philadelphia, he was employed in several architects' offices in New York, after which, in 1900, he returned to Scranton and there began work in his profession. He has been successful to an unusual degree, work designed by him appearing in abundance throughout the locality, many of the most attractive residences of the region executed after his plans. To a complete and thorough knowledge of the technique of his calling he has added an individuality of expression that distinguishes his work, and has won him praise and reputation. Mr. Weinschenk is a Republican in political sympathy, and was at one time a member of Company A, Thirteenth Regiment Pennsylvania National Guard.





*H. M. Edwards*

He is a communicant of the Green Ridge Presbyterian Church, of which his wife is also a member, Mrs. Weinschenk active in the work of the societies of that organization. His fraternal order is the Masonic, in which he holds the thirty-second degree, Ancient Accepted Scottish Rite, and he is also a member of the Nobles of the Mystic Shrine.

Mr. Weinschenk married, June 20, 1898, Helen, daughter of Dr. William and Lydia (Wade) Barnes, her parents natives of Connecticut. They have children, both born in Scranton: Carl A., born in 1904; Arthur A. Jr., born in 1909.

---

#### HON. HENRY M. EDWARDS

Hon. Henry M. Edwards, a lawyer of exceptional ability, president judge of the courts of Lackawanna county, by his own honorable exertions and moral attributes has carved out for himself friends, affluence and position. By the strength and force of his own character, he has overcome obstacles which to some would seem unsurmountable, and his mind has ever been occupied with enterprises for the advancement and welfare of Scranton, the city of his adoption. Scrupulously honorable in all his dealings with mankind, he bears a reputation for public and private integrity, and being sociable and genial, his friends are legion, composed of all classes of society, who estimate him at his true worth.

He was born in Monmouthshire, South Wales, February 12, 1844, son of John M. and Margaret (Morgans) Edwards, who emigrated to the United States in 1864, locating in Scranton, Pennsylvania, where the father engaged in mining, and his death occurred there in July, 1884; the death of his wife occurred in September, 1874, while on a visit to Wales.

The educational advantages enjoyed by Henry M. Edwards were obtained in the public schools of his native place, and in London University, which he entered at the age of sixteen and from which he received the degree of Bachelor of Arts in 1863. In the following year he accompanied his parents to the United States, locating in Hyde Park, Scranton, and being well educated and unusually intelligent, soon attracted the attention of the Welsh literary circle that was then a prominent feature in West Side life. A year after his arrival in this country, his fluent pen won for him a position on the New York Tribune, the attention of the staff of that paper being attracted to him by articles that he had written for the metropolitan journals, touching on important doings in the everyday world in Scranton. In the following year, 1866, he returned to Scranton to edit the Banner of America, a newspaper devoted to the interests of Welsh-Americans, which attained a large circulation and wielded considerable influence in its day, and for two years he remained at the helm of this publication.

At this period of his career, his thoughts turned to the study of what became his life work, the law, and in 1870 he entered as a student the law office of the late Hon. Fred W. Gunster, who afterwards became judge, and with whom he was later a colleague on the bench. In 1871 he was admitted to practice at the bar of Luzerne county. Later he formed a partnership with the late Judge William Ward, which connection continued for three years, when Mr. Edwards withdrew and opened offices of his own, and enjoyed a large and lucrative general practice, rising to the forerank of the younger member of the bar.

While a hard worker as a lawyer, Mr. Edwards was also active in politics, and his ability as a speaker becoming widely known, his services on the stump were in great demand, always in the interests of the Republican party, and he

spoke in various parts of Pennsylvania, in Ohio, Maryland, New York and Vermont. His work in behalf of his party won for him the nomination for district attorney of Lackawanna county in 1885, and his election followed, he receiving a handsome majority. As public prosecutor he earned an excellent reputation for fairness and good judgment, while his legal ability won favorable comment from the profession. In 1888 he was re-elected to that office, proof positive of his popularity and efficiency. In 1891, upon his retirement from the district attorney's office, he resumed the practice of law, only to again enter the political arena in 1893, in the fall of which year he was elected additional law judge. In 1901 he became president judge upon the retirement of Judge Robert W. Archbald, and in 1903 he was re-elected without opposition for a second term of ten years. In the fall of 1913 he was again elected to the same high office, being the sole nominee. Although Judge Edwards has passed the three score and ten mark, he has lost none of his keenness or capacity for work, and time has not dimmed his talents in the slightest degree.

For the past three or four decades Judge Edwards has been a familiar figure at every large Welsh gathering of local and international prominence. He has filled the position of either adjudicator or conductor at all of the large Eisteddfods that have been held this side of the Mississippi in recent years. He is an Elk, a Mason, a Druid, member of the Scranton Club and of several other organizations. On the eve of his seventieth birthday, Judge Edwards was tendered a testimonial dinner by the county officials, and on his birthday was tendered a dinner by the members of the Lackawanna County Bar. A pleasing feature of the former named dinner was the presentation of a large portrait of Judge Edwards to himself, his colleague on the bench, Hon. Edward C. Newcomb, making the presentation. The portrait, done in oil on canvas, is the work of J. B. Schriever, and it is enclosed in a large gilt frame.

Judge Edwards married, November 3, 1870, Jennie Richards, daughter of Thomas Richards, of Scranton, Pennsylvania, the ceremony being performed in the city of Scranton. Children: John R., of whom further; Margaret, married Edward W. Thayer; May, married Edgar A. Jones, attorney and trust officer of the Lackawanna Savings & Trust Company; Anna, married Professor Eugene H. Fellows, teacher in the Scranton High School; Henry M. Jr., resides at home.

John R. Edwards was born in Scranton, Pennsylvania, October 15, 1875. After a course in the public schools he entered Lawrenceville Preparatory School (New Jersey) later matriculating at Princeton University. Returning to Scranton he prepared for the practice of law under the direction of his father, and in 1897 was admitted to the Lackawanna county bar. He formed a partnership with J. Alton Davis, with whom he was associated until the death of Mr. Davis. He has been admitted to all the state and federal courts of the district, is a member of the State and County Bar Association and has obtained a secure position among the leading practitioners of the Lackawanna bar. In 1900 he was appointed supervisor of the twelfth federal census for the counties of Lackawanna, Monroe and Pike; in 1904 and 1905 was collector of poor taxes and in 1910 was supervisor of the thirteenth federal census for Lackawanna county.

---

#### WALTER H. JONES

From Wales came Daniel Jones, grandfather of Walter H. Jones, one of the organizers and present cashier of the Electric City Bank, Scranton. Daniel Jones reached American shores in a highly dramatic but perilous manner. The ship in which he crossed the ocean was wrecked on the New Foundland rocks,







*Halter H. Jones*

he and two companions reaching the shore on bits of wreckage. After regaining their strength, the three men secured work in a slate quarry and when again in funds proceeded to Boston. Later Daniel Jones settled in Carbondale, Pennsylvania. He was a practical miner and after moving to Newcastle opened the first coal mine in that district. He married and was the father of the following children: 1. Annie, married David Jones, born in Wales, and before coming to the United States served in the British navy; he enlisted in the United States navy during the Civil War and was one of the crew of the warship "Congress" and escaped from her by swimming when the "Merrimac" destroyed the Cumberland and created such dire havoc ere suffering defeat from the "Monitor;" he later joined the army and served until the war closed. 2. Roderick. 3. James. 4. William. 5. Henry D., of whom further. 6. Ebenezer, his father's clerk, then with Dale & Company on Lackawanna avenue, Scranton, until his death. During the Civil War Daniel Jones, with three of his sons, Roderick, James and William, enlisted in the Union army and saw hard service, Roderick losing an arm in battle. When shot, his friend and comrade, Thomas Allen, now living on North Hyde Park avenue, saw him fall and at once bore him to the rear, where his arm was amputated. James contracted fever and returned home. David Jones and William continued in the service without serious mishap until the war closed. William and Roderick yet reside in Scranton, the former a member of Griffin Post, Grand Army of the Republic.

(II) Henry D. Jones, son of Daniel Jones, was born in Newcastle, a suburb of Pottsville, Pennsylvania, in 1852. He began work in a coal breaker when but six years of age, being so small at the time that, when snow was deep on the ground his father would carry him to the breakers. He worked as breaker-boy until he was fourteen years of age. The family then moved to a place called Sandy Bank, a suburb of Scranton, now in the city, where he was employed as a clerk by the Richards & Howell Company, on South Main avenue. Later he engaged in the grocery and provision business at 105 South Main avenue. After one year there he bought the building at 1109 Jackson street, where he continued in business until 1898. From that year until his death he was engaged in the real estate business. He married (first) in 1871, Mary, daughter of John L. and Elizabeth Lewis, and they are the parents of: Lewis, now a meat merchant on North Main avenue, married Annie Broadbent, and they have Lois, Wright V., Helen, Mary; Walter H., of whom further; Mina, deceased. He married (second) Mary Jane Lowry, who bore him a son, Oscar Stanley, now in the employ of Rogers & Company, of Scranton. Henry D. Jones was a member of Hyde Park Lodge, No. 339, F. and A. M. He was a Republican in politics, and at one time city assessor. In religious faith he was a Methodist.

(III) Walter H. Jones, second son of Henry D. and Mary (Lewis) Jones, was born in Scranton, December 27, 1873. He was educated in the public schools of the city, which he attended until his sixteenth year. He then entered his father's employ as clerk, remaining until he was twenty-one years of age. He then entered the State Normal School at Bloomsburg, Pennsylvania, remaining until his graduation in June, 1900. The following year he entered the employ of the West Side Bank, remaining until 1904. In that year he entered the newly organized Keystone Bank as teller. Later he resigned and for eight months was associated with the Dime Deposit Bank, now the Scranton Savings and Dime Bank. He then began the organization of the Electric City Bank, which was chartered June, 1910, and opened its doors for business, July 1, 1910, with Mr. Jones as cashier. He brings to this position a well-trained mind, years of banking experience, and an earnestness of purpose

that eminently qualifies him for so important a trust. The bank is a successful one and has already gained a strong position in financial affairs. Mr. Jones is a member of Hyde Park Lodge, Free and Accepted Masons; Washington Chapter, Royal Arch Masons; West Scranton Council, No. 497, R. and S. M.; Lackawanna Council, No. 1143, R. A.; Junior Order of United American Mechanics, Scranton Board of Trade, and Simpson Methodist Episcopal Church. In politics he is a Republican, deeply interested in all that pertains to public progress, but never an office-seeker. His career has been an honorable and successful one, and the future holds for him bright promise.

Mr. Jones married, August, 1907, Rachel Jones, daughter of the late Thomas H. Jones, the pioneer stone cutter and marble worker of this section. His wife taught school in No. 14 for twelve years. She is also a member of the Simpson Methodist Episcopal Church.

---

#### DANIEL W. EVANS, M. D.

The city of Scranton lays a great deal of claim to Dr. Daniel W. Evans for the splendid benefit that has been derived from his useful activities in that place. While a native of Wales and educated in western institutions, all but six years of his professional career has been passed in Scranton; here he has carved for himself a niche high in the medical wall, in addition to holding as sincere a regard for the welfare of the city of his adoption as though his entire life had been passed therein.

His family is an old one in Wales, their residence in the south of that country having been built about 1600, since which time it has been continuously owned and occupied by the descendants of the Evans who caused its erection, it now being the home of a cousin of Daniel W. Evans. Many recruits from the family have seen service in the army and navy of the king, several participating in Napoleon's down-fall at Waterloo, while James Lewis, a great-uncle of Mr. Evans, was distinguished for his bravery in the War of the Crimea. David, grandfather of Daniel W. Evans, was born in Carmarthen-shire, South Wales, in 1800, one of seven brothers and two sisters all of whom, excepting him, engaging in farming, his occupation being that of shoemaker. He married Mary Thomas and had children: Margaret E., Elizabeth, and Morgan L., of whom further.

Morgan L. Evans, son of David and Mary (Thomas) Evans, was born in Tascon, South Wales, in 1837, and in that country grew to maturity and married. He immigrated to the United States in 1868, accompanied by his wife and five children, settling in Iowa City, Iowa, where he resided until 1881. His trade is that of shoemaker, and in the latter year he moved to the western part of the state of Iowa and after engaging in farming for a short time he retired, his present home being in Adair, Iowa. He married Jane, born in 1840, daughter of James and Jane Lewis, of Pennywren, South Wales, and has children: Jane, deceased; David, a physician of Iowa; James, engaged in business in Garfield, Washington; Mary, died in 1879; Daniel W., of whom further; Margaret, resides in North Dakota; William, deceased; Ann, lives in Silver Park, Saskatchewan, Canada; Harriet, resides in Adair, Iowa; Florence, lives in Adair, Iowa; Ruth, lives in Kimball, Nebraska.

Daniel W. Evans, son of Morgan L. and Jane (Lewis) Evans, was born in Tascon, South Wales, June 14, 1866, being brought to the United States by his parents when he was a child of two years. He obtained his early education in the public schools of Iowa City, in 1891, after a four years' course, graduating from the high school at Panora, Iowa. Enrolling in the medical department of the University of Iowa he continued studies there for one year.

subsequently matriculating in the College of Physicians and Surgeons, an institution which has since joined forces with the University of Illinois, receiving his M. D. in the class of 1894. His first field was in South Dakota, where he established in practice the year of his graduation, continuing there until 1900, when he came to Scranton and began the association that has endured with pleasure and advantage for fourteen years. In April of that year he opened an office at No. 217 North Main avenue, remaining in that place until 1909, when he took up his present favorable location at No. 157-159 South Main avenue, where he has attracted and whence he has visited a generous and select patronage. Not long after his arrival in Scranton Dr. Evans opened an institution known as the Scranton Sanitarium and Medical Baths, its present name being the Dr. Evans' Hospital. The hospital has a capacity of fifteen patients, and during its existence Dr. Evans has there treated cases with baffling complications requiring the highest of the surgeon's and physician's art. Aside from the success that has come to him through its agency Dr. Evans is a lover of his profession, an enthusiastic student and worker, and, if the human qualities abound in him as strongly as in most men, he should rejoice and be glad in the power that has been given him and which he has used so wisely and well. There has been an up-hill feature to Dr. Evans' life, for the obtaining of his wide and complete education came through his personal labor, not only in the difficult study but in securing funds to defray his tuition. Since becoming an active practitioner he has at different times left his practice to take post-graduate courses in the leading institutions of Chicago, New York, and Philadelphia, study which has raised him to the height of efficiency. His medical societies are the County, State, and American, and besides having been pension examiner and medical examiner for numerous insurance companies, he was health officer in Dell Rapids, South Dakota.

It is one of Dr. Evans' greatest enjoyments to serve his city in any manner, and as a private citizen has worked earnestly to propagate civic pride and to aid in the establishment of a more strict moral code in the city. In other departments he has also labored for the best interests of Scranton, and on February 19, 1913, he was one of a committee of three appointed by the Scranton West Side Board of Trade to devise some means of protection for the citizens of Scranton against the frequent "cave-ins" that have caused so much expense to the property owners of the city. These accidents are caused by miners cutting away the pillars supporting the roof of the tunnels which ramify under the city from the main shafts outside of its borders, the only excuse for their occurrence being the greed of the owners for the supporting column of coal. Dr. Evans and his committee have given this lawless practice wide publicity, all of the newspapers having taken up the subject, with the result that two hundred and twenty articles dealing therewith have appeared in reputable periodicals. Whatever of benefit shall result from the work of this commission, which has been truly faithful to the trust reposed in it, will bear with it credit to Dr. Evans as a loyal and energetic member of the committee that brought the atrocity forth to the criticism of a suffering public. His political convictions are progressive and he is a member of the Washington party. Dr. Evans organized the Tuesday Club, and is president at the present time, the object of the club being for the betterment of national, state and local civic government, making a special effort towards keeping officials in the line of duty.

On November 11, 1898, Dr. Evans married Rachel, daughter of Daniel and Janet (Williams) Williams, of Scranton, and has three children: Jeannette, a freshman member of the class of 1914, Scranton High School, and Bayard and Aubrey, both students in the Scranton public schools.

## WILLIAM JOSEPH DOUGLAS

It is eminently fitting and proper that as preface to a recital of the life of a member of the ancient Douglas family of Scotland there should be a description of the coat-of-arms of that race, whose part in the glorious and oftentimes bloody history of Scotland was as glorious as the history itself. It is, in heraldic terms, "Argent, a man's heart gules, ensigned with an imperial crown proper; on a chief azure, three stars of the first." This, in ordinary language would be: Upon a field of silver, a man's heart, red, beneath an imperial crown in its proper colors; above the dividing line, upon a blue ground, three stars of silver. Burke's Heraldry names this as "the Paternal arms of the name of Douglas," and quoting Sir Walter Scott's "Marmion," is "the cognizance of Douglas blood wherever found and with whatever arms combined." In Great Britain the several branches of the Douglas family bear different crests and mottoes in addition to the Douglas arms which are common to all the race. Thus some bear above the shield a winged heart, a hand grasping a broken spear, a wild boar, or other device; while there are several mottoes used, as *Lock Sicker, Forward, Audax, Jamais Arriere, Nunquam Post Remus,* and *Never Behind*, most of them having a meaning similar to the latter. While it is believed that the three stars in the arms imply relation to the Murrays of Scotland, from the fact that their arms also contained three stars, nothing more definite is known, but of the crowned beast an interesting story is told. It was assumed by the family as a memorial of the fate of the Good Sir James of Douglas who perished in Spain in 1330, while on a journey to the Holy Land with the heart of Robert Bruce. The dying king had bequeathed his heart to the Good Sir James, who had been his greatest captain, with the request that he would carry it to Jerusalem and there bury it before the High Altar. It is some times stated that Sir James died on his way to the Holy Land and that he had the heart with him at the time in a silver box, but of this Hume, the historian of the family, says: "He carried with him to Jerusalem the King's Heart, embalmed and put into a Box of Gold, which he solemnly buried before the high Altar there; and this is the Reason why the Douglas bear the crowned Heart in their Arms ever since." Truly a beautiful derivation and one well worthy of honor and belief.

The descent of the American members of the family is from Deacon William Douglas, born in Scotland in 1610, who settled in New London, Connecticut, in 1659. There are many interesting points in connection with the generations between this emigrant ancestor and William Joseph Douglas, of this narrative, but space does not permit of their full mention and will only allow the bare outline. For two hundred years the estate of Deacon Douglas remained in the family, his lineal descendants being Deacon William (2) Douglas, born in Boston, Massachusetts, 1645; Richard Douglas, born in New London, Connecticut, 1682; Deacon William Douglas, born in New London, Connecticut, 1708; William Douglas, born in New London, 1731-32; William Douglas, born in New London, 1753; Samuel Douglas, born in Richmond, Vermont, 1784; Samuel Douglas, born in Richmond, Vermont, 1821; William Joseph Douglas. In the immediate families of the direct line from Deacon William Douglas to William Joseph Douglas, there have been sixty-six members, a number which has been multiplied many times by the marriages of children.

Samuel Douglas, father of William Joseph Douglas, was born in Richmond, Vermont. He made agriculture his life pursuit and became a man of prominence in his community, holding numerous local offices, among them that of supervisor of roads. He married Harriet, daughter of Levi and Hannah Bancroft, members of the family embracing the famous historian of that name.

Children of Samuel and Harriet Douglas: John J., a commission merchant of Worcester, Massachusetts; Clara, deceased; Bertha, married William A. Douglas, of Syracuse, New York; William Joseph, of whom further; Henry B., a merchant of New York; George C., a lawyer, practicing in Worcester, Massachusetts.

William Joseph Douglas was born in Louisville, New York, March 9, 1865. He obtained his education in the public schools of Louisville and the Potsdam Normal School, and then entered Middlebury College, receiving the degree of B. S. from the latter institution in 1893, and subsequently held the chair of natural science in Williamsport Seminary for four years. He forsook a pedagogical for a legal career and began the study of law in the office of W. D. Crocker, at Williamsport. In 1897 he was granted admission to the bar of Lycoming county, Pennsylvania, and the following year the same privilege was extended to him by the bar of Lackawanna county. Since his admission to the bar he has engaged in continuous practice, his patronage growing to a large and prosperous clientele. His success has been due largely to the honorable and open course he has pursued in every business relation. Mr. Douglas' place of business is at No. 216 Miller Building. Mr. Douglas is a member of the Elm Park Methodist Episcopal Church, and in politics acts independently. In 1911 he was appointed vice-president of the Delta Kappa Alumni Association and Eastern Pennsylvania Association. In 1913 he was a candidate for judge of the orphans' court, his opponent being Judge Sando.

Mr. Douglas married Mary, daughter of Warren and Nicena (Derby) Dunshee, who had been a member of his class at college. Children: Stewart D., born September 2, 1897; Dorothy, born January 24, 1899; Harriet Bedford, born November 19, 1910.

---

#### WILLIAM G. VAN DE WATER

The early history of the Dutch settlement of Long Island and New York City contains frequent mention of the Van De Water family, they having been among the pioneer emigrants who laid the foundation for the present greatness and prominence of that section.

Peter Van De Water emigrated from Holland in 1644 and was the progenitor of the Van De Waters in America. His son Jacobus was a prominent man and was appointed by Governor Colvey in 1660 town major of New Amsterdam in charge of the Dutch forces at the Battery. Hendrick Van De Water, great-grandson of Jacobus, was an officer in the Continental army under General George Washington. Edwin Van De Water, son of Hendrick was a farmer, married and left issue: John, William C., Edwin, Emily, Elizabeth. William Curtis Van De Water was born at Hempstead, Long Island, October 2, 1804. His boyhood was spent on the farm, but later he learned the trade of locksmith. He located in that district of New York City known as Greenwich Village, now that populous portion of the city lying between Canal and Fourteenth streets. Mr. Van De Water there engaged in business, becoming well known and prosperous. He married Sarah A. Norris, daughter of Israel and Mary Norris; children: Mary, born in 1853, died in infancy; Mary (2), born in 1856, died September 21, 1903; William G., of whom further.

William G. Van De Water, only son of William Curtis and Sarah A. (Norris) Van De Water, was born in New York City and there educated. He began business life in 1873 as errand boy for Calhoun, Robbins & Company, of that city, remaining three years. In 1876 he entered the employ of the Delaware, Lackawanna & Western Railroad under R. F. Westcott, at that time general transportation agent of the company, and manager of the old Dela-

ware, Lackawanna & Western Express. His initial duties were the carrying of mail and communication to the office of President Sloan in New York, and shortly thereafter Mr. Westcott obtained control of the Long Island Express Company, and the young man was transferred to that line as express messenger, baggage master and solicitor between Bushwick and Rockaway. After three months' service in these capacities he was returned to the general offices of the company at Hoboken, where he remained until 1886 in the service of the Express Company, passing through many grades, including messenger, bill clerk, cashier, agent and auditor of express accounts. He was employed in Hoboken during the great railroad strike of 1877 and had a full share in the exciting occurrences of those weeks of disaster to both sides of the controversy. In 1886 he was transferred to the Lackawanna's general office in New York City, where until 1906 he was connected with the auditing department in various responsible capacities. In 1906 he was appointed auditor of disbursements, and on December 7, 1908, auditor of the coal department, succeeding A. S. Baker, and assigned to headquarters in Scranton. This responsible position, which his long years of experience so eminently fit him to fill, Mr. Van De Water now occupies, making Scranton his home. His term of service covers a period of thirty-seven years and during this time his rise has been continuous, a wide gap now separating him from the messenger boy of 1876. He has not only won his way to the confidence of his superior officers but has the love and respect of every man along the line with whom he comes in contact. He is a member of several societies and organizations, professional and otherwise, is a Republican in his political faith, and a member of the Baptist church. His Scranton club is the Green Ridge; his residence No. 533 Madison avenue.

Mr. Van De Water married Charlotte M. Cook, daughter of George and Charlotte (Day) Cook, of English birth, who came with her parents to the United States when two years of age. Their only child, Helen, died in 1893 aged seven months. While this review of the career of Mr. Van De Water marks him as a man of ability and integrity, it would be incomplete without mention of his standing as a citizen, friend and neighbor. While he is best known among the men to whom his business relations are mainly confined, he has many friends beyond the railroad world. He is most genial, kindly-hearted and sympathetic; lives not to himself alone and delights to lend the helping hand to the boys traveling the same road over which he has passed. In rising from the ranks a man often encounters the jealousies of meaner minds, but in Mr. Van De Water's rise it is safe to assert there was no man who did not rejoice as his worth was recognized by the corporation to which he has given so many of his best years.

---

#### REESE HARVEY HARRIS

Reese Harvey Harris is the son of Dr. John Howard and Lucy (Bailey) Harris. The Harris family is of Welsh origin, but a century old in this country, Reese Harris, the emigrant ancestor of the line, having come from Wales about 1800, when but a lad three years of age. He settled in Indiana county, Pennsylvania, and there married Isabel Coleman, a native of that county; children: Elizabeth, married John Stilts; Reese; John Howard, of whom further; Harriet; William.

Dr. John Howard Harris was born in Indiana county, Pennsylvania, in 1847. As a lad he engaged in the Civil War and was among the Union troops who entered Richmond, April 3, 1865. A student of great capacity and con-



centration, he acquired a broad and thorough education. Matriculating at Bucknell College in 1865 he there received the degree of A. B. in 1869, and of A. M. in 1872. In 1885 he was given the honorary degree of Ph. D. by Lafayette College. In 1889 Dickinson College honored him with the degree of LL. D., Colgate University conferring a like title upon him in the same year. His active educational work, after leaving college, began in 1869, when he founded the Keystone Academy at Factoryville, Pennsylvania, and for twenty years was the efficient, able and honored head of that institution. In 1889 he was called to a higher and more useful field of service, becoming president of Bucknell University. Here for a quarter of a century the influence of his character, personality and teaching has been felt by thousands of students. For the past ten years, Dr. Harris has been a member of the College and University Council of Pennsylvania. Dr. Harris' first wife was Mary Ellen Mace, who died in 1879, leaving two children surviving: 1. Mary Belle, who received the degree of Ph. D. from the University of Chicago in 1899, and is at present studying at the University of Berlin, Germany. 2. Herbert F., a lawyer, practicing in Philadelphia. In 1881 Dr. Harris married Lucy A. Bailey, daughter of Harvey H. and Harriet (Tillinghast) Bailey, members of the Bailey and Tillinghast families of Connecticut and Rhode Island, which settled in Lackawanna county in 1816. Children of John Howard and Lucy A. (Bailey) Harris: 3. Reese Harvey, of whom further. 4. George Bailey, of Detroit, Michigan. 5. Spencer T., an instructor in the Wilkes-Barre High School. 6. Coleman J., an instructor in the Keystone Academy. 7. James P., a student in the University of Michigan, at Ann Arbor. 8. Walter W., a student at Bucknell University, class of 1914. 9. Stanley N., a student in Bucknell Academy.

Reese Harvey Harris was born at Factoryville, Wyoming county, Pennsylvania, July 3, 1883. His preparatory education was obtained in the public schools at Lewisburg and at Bucknell Academy, from which latter institution he was graduated in 1899 on the classical and scientific courses. In the same year he matriculated at Bucknell College and was graduated four years later, in 1903, with the degree of A. B. For an additional year's work in political science he received the degree of A. M. After leaving college he was for two years in charge of the department of history of the State Normal School at Mansfield, Pennsylvania, resigning at the end of the second year to enter the law school of Harvard University, from which in 1908 he was graduated LL. B., "*Cum Laude*." In March, 1909, he was admitted to the bar of Pennsylvania and became associated in legal business with the well-known Scranton law firm of Warren, Knapp & O'Malley, of which firm he became a member on January 1, 1914. Mr. Harris is a member of the college fraternity, Phi Gamma Delta, is a Republican in political affiliations and belongs to the Baptist church. He is also a member of Peter Williamson Lodge, Free and Accepted Masons.

On June 1, 1910, Mr. Harris married Christine A. Richards, daughter of Dr. William C. and Elizabeth (Graham) Richards. Her father, Dr. William C. Richards, who was a prominent physician of Bristol, Connecticut, died in 1909. Children of Reese Harvey and Christine A. Harris: 1. Reese Harvey Jr., born April 28, 1911. 2. Elizabeth Graham, born February 9, 1913. The family residence is at La Plume, Pennsylvania, Mr. Harris' place of business being No. 602 Connell Building, Scranton.

## HENRY J. SCHUBERT

With a record of twenty-eight years of continuous service in the employ of the Prudential Insurance Company of America, Henry J. Schubert, superintendent of the company's interests in the city of Scranton, Pennsylvania, has filled this office for a longer period of consecutive time than any of his co-workers. Pennsylvania and New Jersey are the only fields in which he has represented this great organization, and for the past twenty-three years he has been located in Scranton, where his record of service and his able handling of the company's affairs have won him high favor.

William Schubert, his father, was born in Arnst Hauk, near Neustadt, Germany, February 19, 1815, died at Allentown, Pennsylvania, July 31, 1898. He received an excellent education, especial attention being paid to the languages and music, and after his graduation from college, was employed in stores in Weimar, Saxony. While in that city he heard many accounts of America which inspired him with the desire to go to that country, and there seek his fortune. He accordingly sailed in 1836, on the ship, "Vesta," and after a voyage of ninety-six days arrived at New York. After a short time spent in that city he left for Philadelphia, in which city his money was stolen, and he then made his way to Easton, Pennsylvania, where he found employment in assisting the farmers in threshing, etc., later taking up the work of a millwright. His progress toward wealth was not a satisfactory one, and he journeyed to Weisenburg, Lehigh county, and from there to Sumneytown, Montgomery county, where he worked in a powder mill, and accumulated a considerable capital. He then removed to Ziegler's Church, where he became the friend of the German school teacher and Rev. John Helffrich, pastor of the congregation. Through the latter's offices Mr. Schubert became the organist at Dankel's Church, in Greenwich township, and remained there almost five years. During this time he became one of the proprietors of The Hamburg Schnell Post, a paper having a large circulation for that time and place. He made the trip to Hamburg from his home daily, on foot, the distance being six miles. He was finally elected organist of the Longswamp Church, moved into the house belonging to that congregation, and occupied this for a period of fifty-two years. He was also organist of Lehigh Church for twenty-two years, and at Mertztown for fifteen years. He had charge of the choir and taught the school connected with the church. At times he had as many as one hundred pupils, each paying at the rate of two cents per day, and he taught them reading, writing, arithmetic and the study of the Bible. In addition to these labors he taught a number of adults Latin and French, many of his scholars in later years becoming distinguished in the professions, and ascribing much of their success to the thorough training they had received at the hands of Mr. Schubert. He gave instruction in vocal music and on the organ, piano, violin and flute, had charge of a large class of singers, and was the conductor of an orchestra for some time. To a certain extent he followed the profession of civil engineering, which he had studied in his native land. He was notary public five years; revenue assessor for the districts of Longswamp, Maxatawny, Kutztown and Rockland, five years; and for forty years a justice of the peace. His counsel was sought by many persons coming from great distances, and his influence was felt for good throughout the community. He was a member of Reading Lodge, No. 62, F. and A. M. His parents were John Gottlieb and Christianna (Roersch) Schubert, and he had a brother Lewis, of Allentown; Gustave, of Reading; and a sister who lived in Springfield, Illinois.

Mr. Schubert married (first) December 9, 1838, Sarah, born in Marl-

borough township, Montgomery county, Pennsylvania, April 29, 1820, died January 31, 1856, a daughter of John and Eva Zepp. He married (second) October 8, 1857, Matilda Zepp, born in Marlborough township, April 4, 1835, died January 20, 1905, a sister of his first wife. Children by first marriage: 1. Amelia, born in Marlborough township, April 6, 1839, died September 28, 1884; married Edwin Bortz, and had children: Edwin, William, Ida, Alavesta, Ellen, Mary. 2. John, born in Greenwich township, Berks county, Pennsylvania, May 19, 1840. 3. William, born in Greenwich township, August 26, 1841; married Caroline Fegely, and had children: Ellen, Frederick, Herbert, Charles, John H., Harry F., Lovenia, Sarah, all of whom are deceased with the exception of Harry F. 4. Sarah, born in Longswamp township, May 15, 1843; married William H. Keyser, of Springfield, Illinois, and had children: Ida, Mamie, Frank, William. 5. Eliza, born in Longswamp township, February 19, 1845, died there, May 31, 1909; married Henry Wendling, and had children: Maggie, William, Frederick, Eva. 6. Alfred, born in Longswamp township, June 30, 1847, died there, December 20, 1847. 7. Martha, born in Longswamp township, November 11, 1849; married Charles Walbert. 8. Henry J., of further mention. 9. Mary, born in Longswamp township, January 25, 1853, now deceased; she married Frederick Bermelin, and had children: John, Jennie, Edwin. Children by second marriage: 10. James, born in Longswamp township, September 11, 1858, died October 1, of the same year. 11. Milton Z., born in Longswamp township, November 1, 1859; married Annie Frederick, and has had children: Gertrude, Raleigh M. 12. Harvey Franklin, born in Longswamp township, October 11, 1861; now lives in Pittsburgh; unmarried. 13. Edwin Lewis, born in Longswamp township, May 6, 1864; married Louisa ———, and has had children: Paul, Maude, Grace, Mildred, Harold, Edward. 14. Annie Matilda, born in Longswamp township, December 18, 1865; married Charles Neese, of Lansdale, Pennsylvania, and has children: Frances and John. 15. Ellen Jane, born in Longswamp township, December 10, 1867; married Frank Davenport, of Pitman, New Jersey, and has child, Harry. 16. Rosa Emma, born in Longswamp township, February 14, 1870; married Samuel Biery, of Allentown, Pennsylvania, and has children: Erma, Mary, Ellen, James, Woodrow.

Henry J. Schubert was born in Longswamp township, Berks county, Pennsylvania, January 17, 1851. He obtained his education in the public schools there. Upon the completion of his studies he assisted his father for a time in the marble yard owned by the latter, then became a clerk in a store conducted by one of his brothers, at that time associated with John Landes. After a term of service with Dives, Pomeroy & Stuart, Mr. Schubert formed a partnership with a Mr. Schweyer, the two conducting a store under the firm name of Schweyer & Schubert. Retiring from mercantile pursuits, May 4, 1886, Mr. Schubert became an agent for the Prudential Insurance Company of America, in Reading, Pennsylvania, in January of the following year being advanced to the post of assistant superintendent at Phillipsburg, New Jersey. Soon afterward he returned to Reading in a similar capacity, in May, 1889, being stationed at Allentown, Pennsylvania, as assistant superintendent, and on February 1, 1891, was promoted to the office of superintendent. He was then transferred to Oil City, Pennsylvania, and on May 22, 1891, assumed the duties of superintendent in the city of Scranton, where he has remained up to the present time. It has been Mr. Schubert's care that the business of his company in the Scranton region should show the increase that the rapidly growing population of the city would justify and to keep the ratio between the business and industrial expansion and his business an even one. The prosperity that has attended the affairs of the Prudential Insurance Company dur-

ing his incumbency of his responsible office is ample proof that in this he has been successful, and that through his wise direction the company has been a full sharer in the wonderful progress that has attended Scranton in the past quarter of a century.

Mr. Schubert is a thirty-second degree Mason, belonging to lodge, chapter, commandery, consistory and shrine, and is trustee of the Scranton Council. His club is the Temple, and he is a member of the Scranton Board of Trade. The Republican party receives his loyal support, and he is a communicant of the English Trinity Lutheran Church. He married Maria H., a daughter of William Mertz, and has had children: Sallie E., deceased; Susie M.; Mayme J., married K. H. Landt; Ruth E.

---

#### FRANCIS SCHEINFELTER PAULI

Francis Scheinfelter Pauli was one of those energetic and sagacious men of business whose presence in any community imparts a healthy impetus to the current of financial and commercial affairs. He was a man of great force of character and personal magnetism, and it was owing to these qualities which he infused into all he did that his success was in a great measure due. He was of the third generation of his family in America, and of the tenth generation of the family in Europe, it having been prominent in the early days of the Reformation. In the maternal line he is descended from the Van der Sloots, an ancient family of Virginia. The Pauli family has especially distinguished itself in professional lines.

Adrian Pauli was pastor of St. Peter's Church, in Leipsic, Germany, and died in 1611.

George Pauli, second son of Adrian Pauli, studied in the Reformed Gymnasium at Dantzic, then at Heidelberg University, and became professor of ethics in the first named institution, and the successor of Fabricius as preacher in Trinity church. After the death of Fabricius in 1631, a Lutheran was called to the rectorship of the Gymnasium, with whom he had often to combat in polemics for the Reformed faith. He died in 1650.

Reinhold Pauli, younger son of Adrian Pauli, was a student at the Bremen Gymnasium under Professor Martinius. He then studied three years at Groentengen, and also at the University of Leyden, under the celebrated Professor Coccius. In 1663 he went to Heidelberg University, where the degree of Doctor of Theology was conferred upon him, and he was then called to the Gymnasium in Berzstein, as professor of theology. He married into the family of the renowned Reformed minister, Tossamus (or Toussaint), whose ancestor, Peter, had been the friend of Calvin and the reformed of Monpelzard. He then became professor extraordinary at the Marburg University, and was appointed a regular professor in 1674. One of his daughters married Professor Lewis Christian Meig, of Heidelberg; the other married Professor J. H. Hottinger.

Rev. Herman Reinhold Pauli, son of Reinhold Pauli, was born in 1682, the year his father died, and studied at Marburg and Bremen. He was scarcely twenty years of age when he became court preacher, or chaplain, to the widow of Count Adolph, of Nassau-Dilleinberg, and in 1705 went to Brunswick as the first pastor of the Reformed congregation there. He married (first) Elizabeth Meig, and (second) in 1709, a daughter of the Bremen Professor Yungst. In 1723 he was called to Frankenthal, in the Palatinate, where his mother had been born, and he was then called to Halle, to the cathedral built by the colonists from the Palatinate. January 20, 1728, the King of Prussia named him the second minister there, as a pious and learned man "of great gifts of





*Francis A. Paul*

preaching." While at Frankenthal he had published, in 1726, a collection of his sermons, "Die Pfalzische Erstling," also an edition of the Heidelberg Catechism, and a translation of Placette's "The Death of the Righteous," and these works had spread his fame. May 23, 1728, he was installed at Halle, and also became the first professor of theology in the Academic Gymnasium, which had been established in 1709. When the consistorial scharde died, in 1734, he was made the head minister of the cathedral at Halle, and because of the increased responsibilities and duties, resigned the professorship of theology. In 1736 he was appointed an inspector of the Reformed churches and schools at Halle, Wettin, Calve and Aken. November 28, 1727, King Frederick William of Prussia wrote a letter showing his high regard for Mr. Pauli, and this was followed by thirteen other letters from this august hand. Mr. Pauli published twelve doctrinal letters to the students after the style of Professor Frank, of the Halle Orphans' Homes. In 1740 he published an edition of the Heidelberg Catechism; in 1745 he presented the congregation with a hymn book he had compiled, and which contained a hymn of eight stanzas written by himself, "Lobe, lobe, mein Herr Zebaoth." The greatest men of the time were attracted by his sermons, and the king made earnest endeavor to have him a court preacher at the palace in Berlin, but he consistently declined. He died February 5, 1750. His eldest son, Ernest L., became court preacher at Brensberg, and the youngest, George Jacob, became his successor at the cathedral at Halle.

Rev Philip Reinhold Pauli, was born at Magdeburg, and received his education at the Gymnasium in Berlin and the University of Halle. He traveled extensively in Europe with a wealthy uncle, and came to America in 1783 as a teacher in the Academy at Philadelphia, where he received his degree as Master of Arts. He was a preacher in Reading, Pennsylvania. He married Miss Musch, of Easton, Pennsylvania.

Rev. Johannes Pauli, a native of Magdeburg, Germany, came to this country in young manhood, made his home in Philadelphia, and there became a professor in a college. He was an excellent classical scholar and linguist, and a preacher in the German Reformed church. He went to the front in defense of American interests during the War of 1812, and died in Reading, where his later years were spent.

Lewis J. Pauli, son of Rev. Johannes Pauli, was born in Reading, Pennsylvania, and died in Easton, in the same state, at the age of sixty-four years. In association with several others, he owned the present site of Pottsville, where they located a number of coal mines. For a time he lived in Philadelphia, then removed to Easton. He married Sarah Scheinfelter, born in Reading, died in Philadelphia, who was a member of the Lutheran church, but her four children were reared in the faith of the German Reformed church.

Francis Scheinfelter Pauli, son of Lewis J. and Sarah (Scheinfelter) Pauli, was born in Reading, Pennsylvania, March 28, 1823, died in Green Ridge, Lackawanna county, Pennsylvania, April 20, 1899. The earlier years of his life were spent in Reading, Pottsville and Philadelphia, and his education was acquired in private schools in these cities. When he was about twenty years of age he established himself in the mercantile business near Pottsville, conducted this a few years, when he went to Philadelphia for a time, and then to New York, being in the employ of Alexander T. Stewart, in the last mentioned city, for one year. He removed to Scranton, in 1857, starting a store on Lackawanna avenue, subsequently building the block at Nos. 225-227, on the same street, and personally conducted his business there until 1881. His methods were progressive, and he kept well abreast of the times in every detail, and as a result amassed a considerable fortune by this enterprise. Indeed, his

fortune increased to such an extent that after 1881 his entire time was occupied in looking after his various and numerous investments. His old home where his daughter Margaret now resides, is a beautiful dwelling at No. 1554 Sander-son avenue, and was one of the first buildings erected in Green Ridge. In his earlier years Mr. Pauli gave his political support to the Democratic party, but upon the outbreak of the Civil War he joined the ranks of the Republicans, and affiliated with that party until his death. He was a member of Union Lodge, No. 291, F. and A. M., of Scranton, and while living in Easton became a member of the Independent Order of Odd Fellows, a connection he severed when he took up his residence in Scranton. In his youth he was brought up in the creed of the German Reformed church, but as there was no church of this denomination when he came to Scranton, he joined the First Presbyterian Church, and remained a member of that until the Green Ridge Presbyterian Church was ready for services, when he joined that, and was one of its most liberal supporters. He also continually and consistently gave support to the Calvary Reformed Church, in memory of his early training.

Mr. Pauli married Martha Young, of Easton, and they had one child: Margaret F. He was a cheerful and liberal supporter of various benevolent and charitable institutions, and his private benefactions were numerous. His philanthropy was ever tempered with that wise judgment which seeks such means of relieving the necessitous as will tend to the elevation rather than the degradation of the beneficiary, and he aided many to an honorable establishment in life.

---

#### MARTIN RYERSON KAYS

The late Martin Ryerson Kays, of Scranton, whose early death, April 29, 1891, was a great loss to the community, was a great-grandson of John Kays, lieutenant in the Continental army and aide to General Washington, grandson of Benjamin Kays, and son of James Hopkins and Martha Jane (Slocum) Kays, the latter named a daughter of Sidney Slocum, and granddaughter of Ebenezer Slocum, the founder of Slocum Hollow.

Martin Ryerson Kays was born in Providence, Pennsylvania, July 8, 1858. He studied law in the office of Edward B. Sturgis and afterward matriculated in Columbia Law School, graduating in the class of 1883, and was admitted to the bar in January, 1884. A short time afterward he became a member of the firm of McAskie, Kays & Bradbury. He was a lawyer of much promise. He was treasurer of the People's Printing and Publishing Company which published the Prohibition newspaper entitled *The People*, also secretary of the Wilson Lumber Company, and a director of the Eureka Laundry Company. Like his father-in-law, Mr. Fordham, he was an ardent Prohibitionist and devoted considerable time and energy to fighting the saloon evil. In 1888 he was elected and ordained a ruling elder in the Green Ridge Presbyterian Church, one of the youngest men to be thus honored in that church, being only thirty-two years of age. He married, June 26, 1884, Mary Augusta Fordham, daughter of John R. and Isabel Linen (Dickson) Fordham, the latter named a daughter of James Dickson. Four children were born to Mr. and Mrs. Kays, two of whom died in infancy, and the two who survive are George Dickson and Mary Isabel Ryerson.

---

#### JOHN R. FORDHAM

Among the men who came to Scranton in the middle fifties, there was no more forceful character than John R. Fordham. He was born in Montrose,



Pennsylvania, December 6, 1821. Arriving at the age of manhood in the forties he moved to Carbondale and there met and on October 30, 1851, married Isabel L. Dickson, daughter of James Dickson, and sister of the late Thomas Dickson, George L. Dickson, John A. Dickson, and Mary Helen Dickson, who became the wife of Andrew Watt, and later the wife of Hon. Joseph Van Bergen, all deceased excepting George L. Dickson. He came to Scranton with the Dicksons, father and son, in 1855, on the establishment of the Dickson Works, later the Dickson Manufacturing Company, making his residence in Providence. For many years he was outside superintendent of that company, later, on the increase of that great business, he was made superintendent of the shipping department, a position which he filled until his death.

Mr. Fordham was a man fearless moral courage, of most exemplary habits, and an earnest Christian. He had radical convictions against the institution of slavery during the antebellum days, and was therefore an outspoken member of the Abolition party, when to be such was to be called a "crank," and he was very unpopular. He was an active member of the "Underground Railroad," by means of which many fleeing slaves were assisted on their way to Canada and freedom. He lived to rejoice in the abolition of slavery for which he had long worked and prayed. He was equally pronounced in opposition, not only to the use of intoxicating liquors of any kind, but to the (to him) abomination of all abominations, the saloon. He was therefore one of the organizers of the Prohibition party in this country, and of the Prohibition paper, that was for some time published as its organ, entitled *The People*. With no hope of election, and at much trouble and considerable expense, Mr. Fordham several times suffered the use of his name as a candidate for public office on the Prohibition ticket for the purpose of aiding the cause. His name was therefore thoroughly familiar throughout the country as an uncompromising fighter against the liquor traffic. Whilst not permitted to live to see it, he fully believed the time would come when the liquor traffic and the use of liquors as a beverage, with their unmitigated evils, like the curse of slavery, would be done away. Mr. Fordham's hostility to saloons was made practical in his sturdy fighting against any licensed saloons in the thirteenth ward, where he lived, and he had the satisfaction of maintaining a "dry" ward so long as he lived. He was no less outspoken against the use of tobacco and all other vicious narcotics. The following tribute is from the pen of one of the friends and intimates of his family life: "Mr. Fordham will live in the memories of his friends as a man of great activity and ceaseless energy, of clear and decided views, and the utmost courage of his convictions. But the inner circle who knew him best will dwell upon the thought of his sweet and loving home life, which in all these years God rendered so precious and restful to his own family." In 1871 Mr. Fordham moved to Green Ridge and built a handsome residence on the southeast corner of Sanderson avenue and Delaware street, which is now occupied by his daughter, Mrs. Martin R. Kays. Mr. Fordham died February 10, 1891. There were born to Mr. and Mrs. Fordham five daughters, all of whom passed away in infancy save one, Mary A., who married Martin R. Kays. Mr. Fordham was one of the organizers and supporters of the Green Ridge Presbyterian Church, superintendent of the Sunday school and a trustee for many years.

---

#### DR. JOSEPH VILLONE

Two generations of Villones have fostered two exponents of the medical profession, who, although the width of the Atlantic Ocean separated the fields in which they lived and worked, nevertheless each gave to the locality contain-

ing them the fullest fruits of lives passed in constant practice and the greatest benefits of years of study and of experience. The first has gone to claim the reward of a life of devoted and unselfish service; the second, strong and vigorous in his work, spends his days in healing and curing the physically infirm. The first stood in the foremost rank of his profession in Italy, his native land, and there mingled with his people in the performance of his duty; the second, in a land far from that of his birth, is intent upon a like mission.

Vitale Villone, father of Dr. Joseph Villone, was born in the province of Pokenza, Italy, in 1820. He was educated for the medical profession in the gymnasium, the Lyceum, and in the University of Naples, immediately after his graduation from the latter institution establishing in practice at Cirigliano, and was there for half a century actively engaged in professional work. He was among the most learned practitioners of that locality, and was moreover a sympathetic and skillful physician. He married Rosa Fanelli, and was the father of ten children.

Dr. Joseph Villone, son of Vitale Villone, was born in the province of Pokenza, Italy, November 12, 1859. His education was obtained in the same institutions that had furnished instruction to his father, although his decision for the medical profession had not been made as early in life as that of his parent, and he was graduated M. D. from the University of Naples, December 28, 1888. His career further resembles that of his father in that he first established in practice at Cirigliano, where for three years he was an officer of the public health department, and in which city he was professionally engaged for seven years. Realizing that in his profession, as in all other walks of life, America and the United States meant opportunity, he engaged passage for New York, landing in that city in 1895. He immediately proceeded to Scranton, where he became a medical practitioner with an office at No. 425 Sixth street. He was here located for three years, then moved to Hyde Park avenue, and after a two years' residence in that place purchased the property at No. 206 Chestnut avenue, whither he moved his office and where he maintains the same at the present time. On December 26, 1904, Dr. Villone took and successfully passed the examination of the state medical board at Harrisburg, and holds membership in Lackawanna County Medical Society. He has lately received an appointment from the government of his native land as medical examiner of the applicants for admission into the Italian army. To Dr. Villone belongs the distinction of being the first Italian physician in the Lackawanna Valley and it has been great good fortune for the residents of that locality that the first doctor of that nationality to come into their midst should have been one not only of learning and wisdom in medical and surgical lore, but a gentleman in instincts and deportment, one who graces the profession in the county and state. An Independent in politics, Dr. Villone holds membership in Lodge No. 339, F. and A. M., the Independent Order of Odd Fellows, and the Victor Alfieri Club.

---

#### JOHN BENOIRE

There are in Scranton to-day a small number of men who have been intimately connected with its growth from a small forest settlement to a large, prosperous manufacturing center with a population running well up into its second hundred thousand. One of the members of this Old Guard is John Benore, a Canadian, whose association with the business enterprises of the city has covered a period of fifty-five years, although for part of that time New York state claimed his private and business residence.

John Benore was born in Montreal, Canada, September 15, 1832, son of

John and Sarah Benore. In his youth his parents moved to Ogdensburg, New York, where his early life was spent and where he obtained his education. His first employment was in the United States revenue service on Lake Ontario, in which he continued for three years, when he was twenty-two years of age. After a two years' residence in Sacket Harbor, New York, he moved to Redfield, New York, where he purchased fifty acres of land and built thereon a log house. He soon sold his property and moved to Oswego, New York, for a time conducting a market as well as participating in other business ventures, finally coming to Scranton, Pennsylvania, in 1858. Here he entered the service of the Delaware, Lackawanna & Western Railroad, passing through various conditions of service, finally becoming a railroad contractor. While holding this position he was actively engaged in the construction of the tunnel used by the Delaware, Lackawanna & Western road. About the beginning of the Civil War, he returned to New York state and was there engaged in business until the close of that conflict, when he once more located in Scranton and has there ever since resided. He was one of the first building contractors in the city, erecting many houses for the accommodation of the rapidly incoming settlers, to whom the vast industrial advantages of the region were just becoming apparent. In connection with his contracting operations, Mr. Benore opened a mill and lumber yard, conducting a thriving business. As the contractor who houses the population of a growing city is always indispensable, Mr. Benore's services at this time were particularly valuable, since without houses the new arrivals could not remain in the locality, and upon them depended the development of the rich natural resources of the country round about. His work was done upon a large scale, one hundred and sixty men being employed by him at one time. As soon as the future expansion and growth of Scranton became a certainty, other contractors flocked in and the task of building the city was divided among many hands. At the present time Mr. Benore employs about sixty-five men in his contracting work, which is managed largely by his sons. A new line of activity was opened about twenty-eight years ago when he began the manufacture of coffins for T. N. Miller, which he still continues.

Not only in his chosen line of endeavor has Mr. Benore been active, but he is an enthusiastic supporter of anything that promises for the benefit of his city. He is a member of the Board of Trade and played a prominent part in the organization of the Scranton Fire Insurance Company. In the Builders' Exchange he is a director, in which capacity he is also associated with the Master Carpenters' Association. Fraternally he is connected with the Knights of Pythias and the Benevolent and Protective Order of Elks, of which latter he is a charter member and for many years was trustee.

Mr. Benore married Sarah Haywood, a native of England, and of their children three sons reached maturity: 1. George H., deceased. 2. William A., born November 14, 1871; was educated at Wyoming Seminary; married Sarah, daughter of Joseph B. Morgan, of Scranton, who died March 26, 1909. 3. Frank C., born September 9, 1875; he is a member of the Fraternal Order of Eagles and the Firemen's Relief Association; married Jessie W., daughter of Thomas Jeffrey, of Scranton; he has two children: George J. and Frank. At the age of eighty-one Mr. Benore retains all of his youthful business acumen and keenness, withstanding the attack of approaching age through the strength of well preserved vitality and the vigor of a fresh, active mind. In his sons he has able assistants and the assurance of the continuance of the business which he founded and brought to a condition of useful prosperity.

## PATRICK F. CALPIN

As a member of the council of the city of Scranton, as sheriff of Lackawanna county, and as a member of the state senate from Lackawanna county, that district has been well and faithfully served by Patrick F. Calpin. He is a son of Patrick Calpin, a native of Ireland, who came to Scranton in 1865, being employed in the coal mines of the locality. He was ever active in public affairs and was elected assessor of his ward in 1880. He was killed while working at his daily tasks, a mine accident, the terror of such a life and such a community, causing his death. He married Mary Conway, and had children: Kate, married John Flinn; Patrick F., of whom further; James A., married Clara Griffith; Margaret, married M. J. Noon; Thomas F., married Margaret Joyce.

Patrick F. Calpin, son of Patrick and Mary (Conway) Calpin, was born in Scranton, Pennsylvania, March 25, 1872. After attending the public schools and there obtaining a general education, he completed his studies in Wood's Business College. Until 1890 he was employed in the mines, in that year apprenticing himself to the carpenter's trade, four years later engaging in contracting and building, which has been his line for the past twenty years, and in which he has prospered in a satisfactory degree. He was elected to the common council of Scranton in 1898, meeting with no opposition in the two following elections, serving as president of that body during 1900 and 1901, and in 1902 he was the successful Democratic candidate for the state senate, serving in the sessions of 1903, 1905, and 1906, in July of the latter year receiving the nomination of the Democratic party for sheriff of Lackawanna county, an office to which he was elected and which he filled with able constancy for three years, his term expiring in 1909. Mr. Calpin then returned to private life and now is occupied by his many business relations, that of building and real estate, being the principal. He is a director of the Keystone Bank. His political record is one that has done him credit and that has been beneficial to the districts he represented. He is a member of the Benevolent and Protective Order of Elks and the Board of Trade.

Mr. Calpin married, January 22, 1902, Jennie Clark, daughter of Miles and Mary (Conway) Clark, both of Scranton, and resides at No. 1616 Mulberry street.

---

 WESLEY J. WEBBER

Wesley J. Webber, of Dunmore, Lackawanna county, Pennsylvania, is a fine type of that English character which has contributed so largely to the development of the splendid industrial enterprises of the state of Pennsylvania.

Richard Webber, his father, was born in England, and was twelve years of age when he arrived in this country. He found employment on the old "Gravity Road," and later became a stationary engineer. He was a Republican in political allegiance, and is a member of the Episcopal church. He married Elizabeth, a daughter of John Powell, and had seven children, of whom five are living.

Wesley J. Webber, the fifth child of Richard and Elizabeth (Powell) Webber, was born on Harper street, Dunmore, Pennsylvania, in July 1, 1884. He received such educational advantages as the public schools afforded. From his earliest years he displayed mechanical and inventive ability of a high order, and the years of his attendance at school were shortened so that he might devote all his time to the calling for which he was so evidently fitted by nature and by inclination. He found employment with the Scranton Steam Pump

Company, and after a time with the Sprague & Henwood Diamond Drill Company, with whom he remained for some years. He then established himself in business, and has been eminently successful from the very outset. He is a mechanical engineer and the proprietor of a garage at No. 107 North Apple street, and has three men and one boy in his employ constantly. He is a member of the Junior Order of United American Mechanics, of Dunmore, the Independent Order of Odd Fellows, of Dunmore, and holds membership in the Presbyterian church. He takes no active part in politics.

Mr. Webber married, June 29, 1911, Jennetta, a daughter of John MacMillan, born in Scotland, August 18, 1862, came to America in 1884, lived in Scranton three years, then removed to Dunmore. He is a carpenter, having learned the trade in Scotland. He married Ellen Jeffrey, also a native of Scotland, and they have had six children: Jennetta, mentioned above; Thomas, John Jr., Alexander J., two who died in infancy. Mr. MacMillan is a Republican, a member of the Presbyterian church, and a member of Robert Burns Lodge, Independent Order of Odd Fellows, and of King Solomon Lodge,, Free and Accepted Masons. Mr. and Mrs. Webber reside at No. 208 Andrew street, Dunmore, where they have a beautiful and commodious house where their child, Jessie, was born September 2, 1914.

---

#### WALTER J. DEVEREAUX

Educated in Scranton institutions for the joint calling of civil and mining engineer, Walter J. Devereaux has followed that profession in the Scranton locality all of his active life. He is a son of John and Annie Devereaux, and was born in South Wales, September 9, 1878, being brought by his parents to the United States when two years of age. He was educated in the public schools of Scranton, and after finishing his general studies took a correspondence course under the direction of Professor Buckhart in civil and mining engineering. In addition to this preparation Mr. Devereaux successfully took the state examinations for mine foreman and superintendent, passing them with a wide margin. He has been extensively employed with the Delaware, Lackawanna & Western Company and the Delaware & Hudson Company, and has also been connected with the state department of highways. For nine years he was assistant to M. P. Mitchell, county surveyor, and at the last election was candidate for the county surveyorship. The past two years have witnessed Mr. Devereaux's independent establishment in his profession in Dunmore, his advent into this field having been favorably received. His political faith is the Republican, with which party he has ever taken his stand.

---

#### HERBERT L. TAYLOR

Representative of one of the oldest families of Providence township (now Scranton), Lackawanna county, Pennsylvania, Herbert L. Taylor, an eminent lawyer of Scranton, descends from an ancestry among the earliest in New England. The Taylor family is one of great antiquity in England, tracing to the Norman Knight Taillerfer, who fought at Hastings, 1066, there meeting his death at the hands of Leofnine, brother of the Saxon king. The family of the dead knight was liberally endowed with lands in England by William the Conqueror, who held the slain knight in high regard, publicly lamenting his death. The estates in Kent, England, descended to Hanger Taylefer, 1256, and from him sprang John Taylor, who came to America with Governor Winthrop in 1630, founding a family now widely dispersed among the states of

the Union. The name has passed through many orthographical changes to its present form Taylor, but through them all the line can be traced as indicated.

In Pennsylvania the family trace to Reuben W. Taylor, a Revolutionary soldier, an early settler and miller, owning the first grist mill in his section, Providence township. This mill was built by James Abbott and sold by him to his brother, Philip Abbott, and Reuben W. Taylor, his brother-in-law. John Abbott Taylor was born in Providence township, but spent the greater part of his life in Scott township, Lackawanna county, where he owned a farm of several hundred acres. He died in 1866, aged seventy-six years. He married Gartry Ackley, born in New Jersey, whose father was slain by the Indians at Wyoming. Their son, Silas A. Taylor, was born in Scott township, Lackawanna county, October 31, 1818, died aged about eighty years. He was a farmer of Scott township all his life. He married Louise Carpenter, of Abingdon. Their son, Reuben W. Taylor, was born in Scott township, April 11, 1842. He was educated in the public schools, grew to manhood at the home farm and passed the active years of his life engaged in agriculture and kindred pursuits. He is now living in Hyde Park, a well preserved and vigorous gentleman of seventy years. He was justice of the peace and tax collector of Scott township for several years; is a member of the Masonic Order. He married Elizabeth, daughter of Joseph Wheeler, of Greenfield township, a native of Rhode Island, who died in 1844. Mrs. Elizabeth Taylor is living. Children: Dr. Claude E., a physician of Hyde Park; Herbert L., of further mention; George L., of Forest City; Harry E., of Scranton.

Herbert L. Taylor, son of Reuben W. and Elizabeth (Wheeler) Taylor, was born in Scott township, Lackawanna county, Pennsylvania, October 5, 1865. He was educated in the public schools and Keystone Academy, engaging as a teacher after finishing his years of study. Later he began the study of law as a student under Judge Edwards, an eminent lawyer and jurist. He was admitted to the Lackawanna county bar, October 5, 1886, and at once began practice in Scranton. He was assistant district attorney under Judge Edward with whom he was associated until 1894, when he became a member of the law firm of Taylor & Lewis, with which he is yet connected. Mr. Taylor has been admitted to all state and federal courts of the district and has a well established general practice. He is a member of the State and County Bar associations, Scranton Board of Trade and other organizations and societies. He has always been an active Republican, was chairman of the Lackawanna county central committee for several years, was county solicitor three years and is now collector of poor taxes for Providence township, of Scranton city poor district.

Mr. Taylor married, July 20, 1892, Minnie, daughter of William B. and Annie Phillips. Children: William W., Herbert L. Jr., Annie R., Elizabeth W., John A., deceased, Reuben W.

---

#### ALEXANDER BRYDEN.

There are few Pennsylvania families which have been so continuously and so honorably connected with one industry or calling as has the Scotch family of Bryden with the development of coal properties and mining in general, a connection that began in the homeland, Scotland, and has been continued through three generations in this country. The first of these three generations was represented by Alexander Bryden, born in Dailly Parish, Ayrshire, Scotland, March 6, 1799. His home was among the coal mines of that district and soon after he finished school he began work as a miner, later becoming a shaft sinker and mine foreman, qualifying in experience and ability for the



*Herbert L. Taylor*





higher grades of mine employment. In 1836 he leased some coal property on the Polquhirter estate, at New Cumnock, Ayrshire, and also began operations on a lease on the Downiestown estate at Patna, work on his mine at the latter place being discontinued because of an inflow of water from the river Doon, the stream immortalized by the poet Burns.

Alexander Bryden and one of his sons came to the United States in 1842, proceeding directly to Carbondale, Pennsylvania, where they arrived in July. Mining operations were at low ebb at that time and Mr. Bryden accepted the first employment that came to his notice, which was with Hugh Brown, foreman of day laborers for the Delaware & Hudson Canal Company. He was afterward placed in charge of the mine pumps, and in March, 1843, was appointed mine foreman to succeed Archibald Law, who was permanently disabled, caused by a fall of roof slate. Mr. Bryden continued in this position until 1852, when he moved to Pittston, Pennsylvania, there to assume charge of the operations of the Pittston Coal Company. On January 1, 1854, he became the mining superintendent for the Delaware & Hudson Coal Company, which position he held at death. His death occurred in Carbondale, Pennsylvania, August 20, 1854. He was a member of the Presbyterian church. He married (first) Margaret Dick, a native of Scotland, (second) Janet Bell, also a native of Scotland. At his death he left a widow and twelve surviving children.

Andrew Bryden, son of Alexander and Margaret (Dick) Bryden, was born in Dailly Parish, Ayrshire, Scotland, January 10, 1827, and there resided until he was sixteen years of age, when he and his mother and some of his brothers and sisters immigrated to the United States, arriving in Carbondale, Pennsylvania, May 31, 1843, there to join the husband and father, who had preceded them to this country. His trade learned in Scotland was that of blacksmith, but after coming to this country he engaged as a miner at Carbondale, working thus until October 1, 1850, then becoming mine superintendent at Pittston, Pennsylvania, in the employ of the Pennsylvania Coal Company. On April 1, 1851, he was transferred to Dunmore, Pennsylvania. He remained there for about one year in charge of the Dunmore mines of the company, in 1853 returning to Pittston. In May, 1853, he resigned from the employ of the Pennsylvania Coal Company, and for one year was mine superintendent for the Baltimore Coal Company, at Wilkes-Barre, Pennsylvania, at the expiration of that time, June, 1854, resuming his former relation with the Pennsylvania Coal Company as mine superintendent at Pittston. In July, 1895, he became consulting superintendent of mines for the same company and this was the capacity in which he served until his resignation from the company's employ and his retirement to private life, which took place in May, 1901, his death occurring at Pittston, Pennsylvania, August 29, 1901. He was a member of the American Institute of Mining Engineers, and was a prominent man of affairs, being president of the Pittston Water Company, which was afterward sold to the Spring Brook Water Supply Company, president of the Pittston Gas Company, and one of the original stockholders and board of directors of the Miners' Savings Bank, of Pittston, an institution that from its founding in 1869 was a marked success. He held membership for several terms on the school board of Jenkins township, Luzerne county, Pennsylvania, and was a member of the Presbyterian church. He affiliated with the Independent Order of Odd Fellows, joining Cambria Lodge, No. 1, of Carbondale; when he took up his residence in Pittston he transferred his membership to Thistle Lodge of that place.

Mr. Bryden married (first) Ann Law, born in Scotland, daughter of Archibald Law; after her death at the early age of twenty-eight years he married

Isabella Young, likewise a native of Scotland. His third wife was Elizabeth MacDougall, who was also born in Scotland, who survived him. By his first marriage he was the father of six children: Alexander, deceased; Archibald L., of whom further; Alexander, of whom further; Robert, deceased; Mary, deceased; Ann, deceased. The children of his second marriage were five in number: Margaret, deceased; James, deceased; James Y., of whom further; Mary; Elizabeth, deceased. There was no issue from his third union.

Archibald L. Bryden, son of Andrew and Ann (Law) Bryden, was born in Carbondale, Pennsylvania, March 3, 1848. He was educated in the schools of Jenkins township, and Wyoming Seminary, Luzerne county, Pennsylvania, and in young manhood moved to New York City, there becoming a clerk and salesman in the employ of a dry goods house. Gaining experience in this establishment he moved to Pittston, Pennsylvania, and there began independent dealings in the same line, so continuing for thirteen years. He was for a time treasurer and collector of the Pittston Water Company, and after a venture in insurance dealing became chief clerk in the mining department of the Pennsylvania Coal Company, where he remained until the purchase of that concern by the Erie Company in 1901. Mr. Bryden then returned to the insurance business, which he followed until a protracted illness in 1911 made imperative his retirement from active employment. He married, in October, 1876, Anna, born in West Pittston, Pennsylvania, daughter of La Grange and Mary (Brown) Daman, and is the father of: Andrew Clinton, married Elizabeth Nance, of Texas; and Marion Daman, who lives at home. He is a member and elder of the Dunmore Presbyterian Church. The family home is at No. 500 North Blakely street, Dunmore, Pennsylvania.

Alexander Bryden, son of Andrew and Ann (Law) Bryden, was born in Carbondale, Lackawanna county, Pennsylvania, July 2, 1850, and when a boy attended the common schools of Jenkins township, Luzerne county, after which he matriculated at Lafayette College, whence he received his degree in mining engineering in the class of 1871. Prior to his college entrance he had served in the engineer corps in the employ of the Pennsylvania Coal Company. After graduation he renewed his association with this corporation in the capacity of mining engineer. In November, 1878, he went to Central City, Colorado, as assistant superintendent of a gold mine, in the interest of some of the directors of the Pennsylvania Coal Company, the president of that company being a member of the party. Returning to Pennsylvania, October 1, 1879, he was once more, in April, 1880, sent west as superintendent of the Colorado Prince Gold Mining Company, with which also some of the officers of the Pennsylvania Coal Company were financially interested, and was located at Leadville, Colorado, for a period of two and one-half years. He once more returned east and became mine foreman for the Pennsylvania Coal Company at Pittston, Pennsylvania, December 1, 1882, five months later, in April, 1883, journeyed to Arizona to accept the superintendency of the Detroit Copper Mining Company, of Morenci, Arizona. For fourteen months he remained in the service of that concern in Graham county, Arizona; in June, 1884, returning east becoming assistant mine superintendent at Pittston for the Pennsylvania Coal Company. In July, 1895, he was promoted to the superintendency of the mines of the company in both Pittston and Dunmore districts, an office he held until the purchase of these interests by the Erie Company in 1901. For one year thereafter Mr. Bryden was their mining engineer; in October, 1902, becoming consulting engineer for the Pennsylvania Coal Company, the Hillside Coal and Iron Company, and the New York, Susquehanna & Western Coal Company, offices he holds at this time (1914).

Mr. Bryden is a member and past president of the Engineering Society of

Northeastern Pennsylvania, member of the American Institute of Mining Engineers, and the Geographical Society of Washington, District of Columbia, while aside from his scientific connections, he affiliates with the societies of Knights of Honor and the Royal Arcanum. He is a member and trustee of the Dunmore Presbyterian Church, and as a Republican was at one time a member of the school board of Pittston, Pennsylvania. His only outside business relation is as a director of the Miners' Saving Bank of Pittston, a position, which, like so many of his offices, his father held before him. Mr. Bryden's achievements in his profession have been far removed from the ordinary, and are the works of a man trained and proficient in a difficult calling, one in which, as in everything worth while, the battle goes only to the strong.

Mr. Bryden married, October 18, 1872, Margaret, daughter of William and Catherine Law, her parents natives of Scotland. To Mr. and Mrs. Bryden, whose home is at Fifth and Dudley streets, Dunmore, Pennsylvania, the following children were born: Annie, Katherine, William L., Andrew D., Helen, deceased, and Margaret. Mrs. Bryden died July 31, 1905.

James Y. Bryden, son of Andrew and Isabella (Young) Bryden, was born in Jenkins township, Luzerne county, Pennsylvania, May 26, 1866, and in his youth attended educational institutions in Pittston and Wilkes-Barre, Pennsylvania, also spending one year in Lafayette College, at Easton, Pennsylvania. He then entered the engineering department of the Pennsylvania Coal Company and was assigned to duty at Pittston, Pennsylvania, afterward becoming engineer in the employ of the Scranton Gas and Water Company. Since 1910 Mr. Bryden has been superintendent of the Dunmore Cemetery Association, whose affairs he capably directs (1914). His political creed is Republican, and he is a communicant of the Presbyterian church. He married Florence, born in Pittston, Pennsylvania, daughter of Alexander Robertson, and has one daughter, Isabell. He resides at No. 511 Elm street, Dunmore, Pennsylvania.

---

#### GEORGE W. B. ALLEN

Mr. Allen's activities since becoming a resident of the Scranton district have been varied in nature and include mercantile dealing, employment with the Pennsylvania Coal Company, and finally insurance dealing, in which he engages at this time, being city manager and special agent of the Prudential Life Insurance Company, his office No. 824 Connell Building, Scranton. Mingled with these business connections have been several terms of public service in Dunmore, of which borough he has been a resident for twenty-eight years, so that his life has been one of busy interests, to all of which he has attended with constant fidelity.

George W. B. Allen was the first of his line to move to Pennsylvania, the family being of New England ancestry, his parents, Jabez and Olive (Barnum) Allen, moving from that region to New York state, where they died, he in 1886, aged eighty-two years, she in 1868, aged fifty-eight years. Jabez Allen was a farmer and carpenter, at different times operating a sawmill and managing a wheelwright shop. Jabez and Olive (Barnum) Allen were the parents of five children, of whom but two survive, George W. B., of whom further, and William.

George W. B. Allen was born in Monticello, New York, October 16, 1848, and was there educated, in young manhood teaching school for three years. Prior to moving to Pennsylvania he was for two years a clerk in a general store. In 1871 he began an association with the Pennsylvania Coal Company that endured for twenty-two years, all of which were spent in the shipping

department, sixteen years being passed in Hawley. For the past twelve years he has been handling fire and life insurance, and has been connected with the Insurance Title Guaranty Company, being now city manager and special agent for the Prudential Life Insurance Company. In 1887 he engaged in mercantile dealings in Dunmore. He is a Republican in politics and has been thrice elected for three-year terms as assessor of Dunmore, resigning in the latter half of his third term to devote his entire time to his business relations, and has, at different times, furnished bond for the borough treasurer and collector of Dunmore. Mr. Allen is a member of King Solomon Lodge, Free and Accepted Masons, and the local lodge of the Knights of Malta, in the latter having been recorder for nine years and treasurer for two years, his membership therein covering a period of seventeen years.

As a Presbyterian, Mr. Allen has been exceptionally active in church work, holding position in the session for twenty years and the superintendency of the Sunday school for the past fifteen years. In these capacities he has been the instrument of great good in the Dunmore community, accepting his duties in a spirit of reverence and discharging them to the fullest extent of his ability for the advancement of Christianity and the benefit of his people in church and Sabbath school.

He married Harriet E., daughter of David J. Smith, an early settler of Dunmore, Pennsylvania, superintendent of the water works at that place. Mrs. Allen is the eldest of five children, three of whom are living: Andrew C., of Pittston; Mrs. Edward Gogel, of New Haven, Connecticut, whose husband is chief engineer of the New York, New Haven & Hartford Railroad; and Mrs. Allen. She has taken an active part in church work and has been secretary of the Ladies' Aid Society for twenty-five years.

---

#### PATRICK J. HORAN

If there is one business concern in the Scranton district whose strength and prosperity justly reflects the efforts that have been put forth to raise it to the head of institutions of its kind, that one is the Union Cash Stores Company, conceived and founded by Patrick J. Horan, one of the leading merchants and financiers of the locality. Patrick J. Horan is a son of Patrick Horan who moved to Carbondale, Pennsylvania, in 1845, entering the mines of the Delaware & Hudson Company. He was afterward appointed tipstaff under Judge Handley, and at the expiration of his term of service retired to private life, his death occurring in Dunmore, Pennsylvania, at the age of eighty-nine years. He married Catherine Ford, who died July 1, 1896. They were the parents of: Anthony, one of the superintendents of the coal department of the Pennsylvania Coal Company, died September 30, 1896; Patrick J., of whom further; Bridget, died in Dunmore; Meche J., senior partner of the firm of Horan & Merrill, of Scranton; Catherine and Annie.

Patrick J. Horan was born in Ireland, and was brought to Carbondale by his parents when he was one year old. He was there reared and educated, at the age of thirteen years beginning his business career as a driver in the coal mines in Dunmore. Later becoming a practical miner, he was thus employed for several years, afterward accepting a position as weighmaster, serving thus for ten years. At the close of that time he made his entry into the mercantile world, his success and prosperity dating from that period, for two years being associated with the firm of Bryden Brothers & Cooper, later forming a partnership with Williamson & Company. They established in business on Chestnut street, for two years conducting profitable general mercantile dealing. In 1870 the firm of Horan & Healy was formed, and in 1881 Mr. Horan

purchased the stock and store of Hinsdell clothing house in Scranton, managing the same for three years. Retiring from this line, Mr. Horan organized the wholesale grocery firm of T. J. Kelley & Company which operated until 1905. After the death of Mr. Healey who was at the head of the company, the firm went out of business. While under the firm name of Horan & Healey, Mr. Horan continued in general trade on Chestnut street, Dunmore. In 1896 in conjunction with Messrs. Manley and Swift, two prominent merchants of Dunmore, he incorporated the Union Cash Stores of Dunmore, the duties of the partners being so divided that the responsibility of the grocery department rests with Mr. Swift, that of the general store with Mr. Manley, and the weight of the whole upon Mr. Horan, the president. He was also president of the Scranton Packing Company, which is now out of business; director of the Economy Light and Heating Company, now controlled by the Scranton Electric Company; has been president of the Fidelity Deposit and Discount Bank of Dunmore from its organization in 1903; director of the Lackawanna Trust and Safe Deposit Company. Some of the other organizations with which Mr. Horan is connected are: Eureka Specialty Company; Consumers' Ice Company, of which he was one of the organizers, the company controlling Lake Henry and Lake Poyntelle, on which bodies of water vast storage houses are built. He was interested in the Mississippi Central Railroad Company; was one of the incorporators of the Lackawanna Lumber Company, later changed to the United States Lumber Company, and is now holding large interests in that company, and at the present time holds wide interests in real estate and building operations. He was president of the Dunmore Board of Trade, and in this position did much to publish the attractions of the city and to place the attractions of the city, its desirability and advantages before those whose presence would benefit Dunmore. For three years he served as a member of the borough council, there, as everywhere, gladly giving his best advice in earnest suggestion, and after the adoption of a plan, placing his shoulder to the wheel and laboring tirelessly to realize the goal to which the body aspired. The even, attractive sidewalks of Dunmore are largely due to Mr. Horan's agitation of the subject of improving the borough's walks, which at the beginning of his campaign were in a disfiguring condition, Dunmore now having more miles of this kind of sidewalk than any other place of its size in the state.

It would be too great a task to enumerate the virtues and qualities that have induced the above record. Let it suffice to say that from a lowly position to recognizance in the mercantile world and a high position in other lines of endeavor he has striven earnestly, relentlessly, and cheerfully, accepting his triumphs without undue ostentation, learning wisdom and caution from each reverse. The strictest honor and the most upright integrity have permeated his slightest dealing, and progress has been the watchword of his upward course.

Mr. Horan married Mary A., daughter of Michael and Catharine Garvey, of Dunmore, and a sister of Bishop Garvey, of Altoona, Dr. James B. Garvey, of Dunmore, and Catharine Garvey Curtin, of Dunmore.

---

#### MICHAEL J. SWIFT

Michael J. Swift, senior member of the firm of Swift, McCrindle & Company, wholesale merchants, of No. 440 Sixth avenue, Scranton, has been all his life connected with mercantile dealings. He is a son of Michael and Honora (O'Boyle) Swift, both deceased, and was born in Dunmore, Pennsylvania, January 24, 1859, there attending the public schools, his scholastic training including high school instruction. In 1882 he began his association

with mercantile firms as a clerk in the store of T. H. Watts, later becoming a road salesman and so continuing for twenty years, during the last five years of that time being a member of the firm of T. H. Watts & Company. At the end of that time he formed a partnership with John McCrindle as Swift, McCrindle & Company, wholesale merchants, their line including flour, cheese, butter and eggs. The firm's business is one of generous proportions, and is conducted on safe and conservative business lines, both partners merchants of long standing, men of sound and honorable principles which they apply to all of their dealings. Mr. Swift is a Democrat in politics and has held public office as the candidate of that party. He is a member of the Scranton Board of Trade, the Knights of Columbus, and belongs to St. Mary's Roman Catholic Church.

Mr. Swift married Etta, daughter of Cormick Cummings, of Honesdale, Pennsylvania, and has children: Harold, Horace, Regina, Laura. The family home is at No. 1739 Quincy avenue, Dunmore, Pennsylvania.

---

#### HARRY M. SPENCER

The history of the development of the natural resources of the Scranton district, and particularly of the locality now known as Providence, contains prominently the name Spencer, the connection extending over three generations. It is now, in the person of Harry M. Spencer, associated with the manufacturing interests which the development of the natural riches of the region made possible, Mr. Spencer president of the Perpetual Spark Plug Company, of Dunmore, Pennsylvania.

Mr. Spencer is a great-grandson of Sylvester Spencer, a victim of the Wyoming Massacre, grandson of Edward Spencer, and son of Andrew D. Spencer. Edward Spencer, soon after making his home in the Lackawanna Valley, became owner of all the land between East and West Mountains, the greater part of which he retained, mining coal and operating in timber. A small part he sold, and some he leased to the Roaring Brook Coal Company, his sons, F. M. and Andrew D., later assuming the conditions of the lease, and with their nine brothers and sisters forming the Spencer Coal Company.

Harry M. Spencer, son of Andrew D. and Emma (Albright) Spencer, was born in Dunmore, Lackawanna county, Pennsylvania, June 21, 1867. He obtained his education in the Dunmore public schools, the Keystone Academy, and the University of New York, graduating from the last-named institution in the class of 1886. After a course in Rogers' Business College, of New York, he was instrumental in the organization of the Spencer Coal Company, previously mentioned, and for seven years was connected with the direction of its business. At the end of this time he organized the Perpetual Spark Plug Company, of Dunmore, and has since devoted himself to its interests, although retaining his one-fourth ownership in the Spencer Coal Company.

The Perpetual Spark Plug Company, H. M. Spencer, president, H. E. Twaddle, secretary and treasurer, and J. Warfel, superintendent, has been engaged in the manufacture of spark plugs for the past two years, having been established in 1912. On April 1, 1914, the company placed upon the market the "Ezekleen," a plug for which its manufacturers claim superiority above all other makes, claims substantiated by its many users. Permanence is only one of its points of difference, for it is not known ever to have been short-circuited by oil or carbon, a most unusual record. The plant of the Perpetual Spark Plug Company is at No. 330 East Drinker street, Dunmore, and although the parts of the plug are manufactured elsewhere, assembly is made at this place, where the thirteen persons employed complete the assembly of three





*Frank J. Sedlak, M.D.*



hundred plugs daily. Mr. Spencer is the sole owner of this business, which is but in its infancy, and with the perfection of the marketing system of the company's product, which already is widely handled, the Perpetual Spark Plug Company should experience almost unprecedented growth and expansion. Mr. Spencer's other business relations are as director of the First National Bank, of Dunmore, of which he was the first vice-president and an organizer, as executor of the A. D. Spencer Estate, and as trustee of the A. O. Spencer Trust, of Philadelphia. He was formerly president of the Roxbury Distilling Company, of Roxbury, Maryland. Mr. Spencer fraternizes with the Benevolent and Protective Order of Elks, is an Independent in politics, and was at one time a member of the Dunmore school board.

Mr. Spencer married Callie P., daughter of the late D. Frank and Clarissa (Pratt) Hayes, her father born in Tariffville, Connecticut, her mother in North Middleboro, Connecticut. Mr. and Mrs. Spencer have one daughter, Catharine, aged eleven, attending the School of the Lackawanna; two of their children died in infancy.

---

#### JOHN F. MCGUIRE

John F. McGuire, a native of Dunmore, Pennsylvania, has there passed his entire life, in his youth attending the public schools of that place, now an undertaker and funeral director there. He was born May 24, 1878, son of Stephen and Bridget McGuire, and after finishing school formed a partnership with a Mr. Kane, opening an office at No. 312 Chestnut street. This association was begun in August, 1900, and later dissolved, Mr. McGuire establishing in independent business on January 16, 1911. In 1913 he moved to his present location at No. 319 Chestnut street, where he has since been successfully engaged in business. He holds membership in the Liverymen and Undertakers Association, Nine County Funeral Directors Association, the Fraternal Order of Eagles, the Modern Woodmen of the World, the Knights of Columbus, the Young Men's Institute, Ancient Order of Hibernians, Home Circle, and the Young Men's Temperance Literary and Benevolent Association. His political party is the Democratic.

---

#### FRANK J. SEDLAK, M. D.

A native of Austria Hungary and since seven years of age a resident of the United States, Dr. Frank J. Sedlak has devoted his life to medical work, all of his active practice having been confined to the city of Scranton. He was born October 16, 1873, son of John and Anna Sedlak. His general education was obtained in the schools of Wilkes-Barre, Pennsylvania, and his preparatory course for the medical college under A. C. Staley of Chicago. He then entered the Illinois Medical College of Chicago, whence he was graduated M. D. in the class of 1906. Since that year he has been a practitioner of Scranton, his office at No. 950 Prescott avenue, where he has attracted a considerable patronage. He holds membership in the County and American Medical societies. He belongs to Holy Trinity Roman Catholic Church. Politically he is independent, clinging to no one system of party action nor adhering to one political creed. Dr. Sedlak married Mary Joseph, daughter of Michael and Mary Joseph, a native of Mount Carmel, Pennsylvania.

## PATRICK D. MANLEY

First as a merchant, later as a lumber dealer, and finally as a dealer in real estate, Patrick D. Manley has been connected with the business interests of Dunmore, Pennsylvania, continuing in the last-named line as the largest individual real estate dealer in the borough. Patrick D. Manley, born in Ireland, is a son of Dominick and Bridget Manley, both natives of that country, who came to the United States with a family of nine children in 1863, his father dying at Hawley, Pennsylvania, his mother in Dunmore, Pennsylvania, both members of the Roman Catholic church.

Patrick D. Manley was born in Ireland, May 1, 1843, there being educated and coming to the United States with his parents when twenty years of age. He remained in Hawley, Wayne county, Pennsylvania, from June 21 until November 1, 1863, at the latter date proceeding to Dunmore, Pennsylvania, where he has since resided with the exception of two years passed in Wilkes-Barre, Pennsylvania. While living at home he assisted his father on the farm, later opening a small mercantile establishment on Chestnut street, Dunmore, where he remained until 1876. In this place he gained some invaluable experience in methods of operating a store, knowledge which was secured in rather a costly and unpleasant manner but which he well remembered and made use of at future dates. The lesson referred to was the extension of credit to irresponsible persons, bills accumulating upon which he was never able to collect. In 1876 he moved to a large brick store one block below his former place of business, his new location being No. 213 Chestnut street, admitting to partnership Thomas F. Cawley and John E. Swift, the establishment now known as the Union Cash Store. Mr. Manley later sold his interest in this business and for fourteen years was a lumber dealer under the name of the Dunmore Lumber Company, selling the business that he had built up on February 28, 1912. Since that time he has applied himself entirely to real estate transactions, and at the present time holds title to more real estate in the vicinity of Dunmore than any one other man, and since making that his chief concern has been involved in the transference of a great deal of property. His only other business association is as a director of the Fidelity Bank. Mr. Manley is a member of the Catholic Mutual Beneficial Association, the Temperance Society, and belongs to St. Mary's Roman Catholic Church. A Republican in politics, he has for seven years served Dunmore in the capacity of borough treasurer, holding that office for six consecutive years.

Mr. Manley married (first) in Dunmore, Pennsylvania, Margaret Elizabeth Harrison, born in Hawley, Pennsylvania, daughter of Patrick Harrison, a native of Ireland, who immigrated to the United States, settling in Hawley, Pennsylvania. Mrs. Manley died in 1885. Mr. Manley married (second) Mary, daughter of Patrick Seery, of Dunmore, Pennsylvania. Children of Mr. Manley's first marriage: John, Frank, Elizabeth, Mary, Genevieve, deceased. Children of second marriage: Catherine; Josephine, deceased; Joseph, deceased.

---

 JAMES RUSSELL MURPHY, M. D.

A decade is the space of time that has elapsed since there was taken from his earthly walk Dr. James Russell Murphy, who for nearly a quarter of a century prior to that time had been a familiar figure in Dunmore as he went about on his errands of mercy. More than another decade, and still another, will be necessary to blot from the minds and hearts of those who knew him the sweetness of his character, the kind consideration of his nature, the warmth

and cordiality of his presence. It is the lives of such as he that give value to a look into the past pages of life, and make otherwise melancholy retrospect worth while.

Dr. James Russell Murphy, born in Ireland, was a son of Columbus and Eleanor (Russell) Murphy, his mother dying in Ireland, his father in Rhode Island, whither the family had immigrated when James Russell was a boy of thirteen years. After obtaining a general education, he attended the Medical University of Louisville, Kentucky, receiving his M. D. from that institution in the class of 1882. In November of the year of his graduation he moved to Dunmore, Pennsylvania, where he was continuously engaged in practice until his death, March 27, 1905. Usefulness was the keynote that sounded throughout his entire career, and the sacrifices that he made in the line of duty moulded his life and character into radiant beauty that endeared him to the hearts of many. He was a member of several medical societies. He belonged to St. Mary's Roman Catholic Church, and affiliated with the Improved Order of Heptasoph.

Dr. Murphy married, April 24, 1884, Sarah A., daughter of Michael and Sarah (Ferguson) O'Neill, a native of Dunmore, Pennsylvania, where she was reared. She was for sixteen years a teacher in the schools of Dunmore, resigning her position prior to her marriage. Michael O'Neill was a son of John O'Neill, who in Ireland, the homeland, was a butcher, living retired after settling in Dunmore, Pennsylvania, where he was a pioneer settler. Michael O'Neill met an accidental death in the coal mines of Dunmore, in 1852. His wife was a daughter of Robert Ferguson, of Ireland. Children of James Russell and Sarah A. (O'Neill) Murphy: Joseph R., ex-borough engineer of Dunmore, Pennsylvania; Eleanor, Bessie, Mary, Sallie.

---

#### FRANK V. MATTHEWS

Since 1904 an employee of the Erie Railroad, Frank V. Matthews is now associated with that road as store-keeper of the Wyoming Division, and is located at Dunmore, Pennsylvania, in which borough he also holds residence. He is a son of Sidney and Sophia (Vaughn) Matthews, and was born in Scranton, Pennsylvania, June 8, 1881.

Sidney Matthews was born in England, where he also received his schooling, coming to the United States at the age of thirty years. He took up his residence in Scranton, Pennsylvania, and was employed for a great many years by the Delaware & Hudson Railroad as locomotive engineer. He is an Independent in politics, and a member of the Episcopal church. He resides in Dunmore, Pennsylvania. He retired some twenty years ago from the railroad business. He married, in Scranton, Pennsylvania, Sophia Vaughn, a native of Manchester, England, a daughter of Thomas Vaughn. She came to Scranton at about the age of twenty-five years. She knew her future husband in England. She became the mother of eight children: 1. Edith S., wife of William R. Wilson, deceased, of Dunmore. 2. Eva, died at age of one year. 3. Stella A., deceased, was the wife of Homer Miller, of Ancran, Columbia county, New York. 4. Annie E., wife of G. E. Card, of Ancran, Columbia county, New York. 5. Maude, wife of W. H. Williams, of Salamanca, New York. 6. Gertrude M., wife of Captain L. G. Adams, of Greensburg, Pennsylvania. 7. Frank V., of whom further. 8. Stanley W., unmarried, of Scranton, Pennsylvania.

Frank V. Matthews received his school training in the institutions of the city of his birth and of Dunmore. Leaving school, he was for a short time connected with the Scranton Bolt and Nut Company, leaving that company

to accept a clerkship with the Erie Railroad, being first time-keeper in the Dunmore shops of that company. In 1910 he was raised to the position he now occupies, that of division store-keeper, discharging the duties of his place in a capable and reliable manner that has won him favor and approbation from his employers. Mr. Matthews fraternizes with the Independent Order of Odd Fellows and the Masonic Order, in the latter society belonging to King Solomon's Lodge. He is also a member of the Railway Storekeepers' Association, and is a communicant of St. Mark's Episcopal Church. He is a stockholder in the Fidelity Deposit Bank, of Dunmore, and a staunch Republican. He has held the office of borough auditor since 1908, having been first elected in that year and re-elected three years later.

Mr. Matthews married Grace, daughter of John and Margaret Devine, her father, who was a son of Albert and Grace Devine, was superintendent of the Dickson Works for thirty years, now deceased, of Scranton. Mr. and Mrs. Matthews, whose home is at No. 316 North Blakely street, are the parents of: Margaret Romaine, born in 1906; Donald V., born in 1909.

---

#### EDWIN M. BEYEA

For over a quarter of a century Edwin M. Beyea, of Dunmore, Pennsylvania, was associated in different capacities with the Pennsylvania Coal Company, Hillside Coal & Iron Company, and Erie & Wyoming Valley Railroad Company, a connection he was obliged to discontinue recently owing to ill health to accept a position as special agent with the same companies requiring less responsibility. He is the proprietor of the Nay Aug Stone Company, and is connected with other business interests in the Lackawanna Valley.

He is a son of the late Henry Beyea, who was treasurer and paymaster of the old Erie & Wyoming Valley Railroad Company, and cashier of the Pennsylvania Coal Company up to the time it was taken over by the Erie Railroad. Previous to his illness in 1913, Mr. Beyea was regarded as an expert with gun and rod and there is no one more familiar with the forests of Wayne and Pike counties than he. Mr. Beyea is a fancier of Jersey blooded cattle and has most valuable stock under one roof in Pennsylvania, on farm at Maplewood, which was left by his father. He is secretary and treasurer of the Taxpayers Association of Lackawanna Valley, holds membership in the Presbyterian church, and a Republican in politics. His present residence is at 1630 Monroe avenue, Dunmore, Pennsylvania. Mr. Beyea married Ida May Mullen, of New Jersey, and has one son, Frank Darns.

---

#### PATRICK H. CAWLEY

Appointed justice of the peace in 1912 to fill out the unexpired term of B. J. Kelly, and on November 21, 1913, elected to that office for a term of six years, five years must still pass before Patrick H. Cawley will have completed the duties of justice of the peace, which he has for two years discharged with competent ability. He is a native of Lackawanna county, Pennsylvania, his birthplace Gouldsboro, the date of his birth February 28, 1869. He was reared in Pittston, Pennsylvania, and there attended school, afterwards becoming associated with F. J. Johnston, of Scranton, painter and paper-hanger, a business in which Mr. Cawley embarked independently in 1903, adding to his activities in this line a collection agency, which he still maintains. His responsibilities to himself in the care of his business and to Dunmore in the conscientious filling of his office are met on a fair footing, both receiving his undivided attention in their own proper time and place. He is a member of





*Geo. E. Stearns*

Scranton Lodge, No. 123, B. P. O. E., the Temperance Lodge, and the Ancient Order of Hibernians. Politically a Democrat, he is a member of St. Mary's Roman Catholic Church.

Mr. Cawley married Millie Corcoran, born in Olyphant, Lackawanna county, Pennsylvania, and has children: Julietta, born in Pittston, Pennsylvania; John, born in Olyphant, Pennsylvania; Edward and Regina, born in Olyphant; Mary, Harry, Willard, and Helen, all born in Dunmore, Pennsylvania.

Mr. Cawley's office is at No. 214 East Drinker street, Dunmore, Pennsylvania, while his residence is No. 332 Blakely street.

---

### JOHN CARNEY

The president of the Carney and Brown Coal Company, of Dunmore, Pennsylvania, is John Carney, with whose life this brief account will concern itself. Son of Michael and Winifred (Connell) Carney, he was born in Ireland, January 29, 1843, and when he was five years of age was brought to the United States and to Dunmore, Pennsylvania, by his parents. In this latter locality he was educated, after the completion of his schooling entering the employ of the Delaware & Lackawanna Railroad Company, later becoming identified with the service of the Pennsylvania Coal Company, and following that the Gravity Railroad. For more than twenty years he was then a railroad engineer, in 1888 resigning from the railroad service and associating himself with coal dealing, in which he now engages as the president of Carney and Brown Coal Company, of which he has been the head since its organization. His entire active life has been passed in Dunmore, which has been his home for sixty-five years, and there he has been connected with numerous enterprises and movements for the advancement and welfare of that place. School improvement is a form of municipal responsibility in which he has worthily borne his part, having served as school director and for three years as school controller. He holds membership in St. Mary's Roman Catholic Church, and belongs to the Knights of Columbus.

Mr. Carney married (first) Mary Caveny, a native of Ohio, and had two children, Mary and Sara; (second) Catherine Fitzpatrick, of Jefferson township, Lackawanna county, Pennsylvania, and has one daughter, Helen.

---

### GEORGE E. STEVENSON

Among the ranks of civil and mining engineers in the city of Scranton, George E. Stevenson holds a conspicuous position, both because of his high standing in his profession and the prominence of the firm of which he is a member, Stevenson & Knight, and because of his wide experience in his chosen calling. His parents were both natives of Pennsylvania, his maternal grandfather, Stephen Parker, having been one of the first settlers in the township of Abington, Lackawanna county. His mother is still the possessor of a portion of the land that formed the original homestead, and there lives.

George E. Stevenson was born at Danville, Montour county, Pennsylvania, March 30, 1860, and spent his boyhood on the old farm in Abington. He obtained his early education, preparatory to his entrance of Cornell University, in the public school at Clarks Green. His father was a civil and mining engineer, having been employed in the construction of the original line of the Delaware, Lackawanna & Western Railroad, and by acting as his assistant in his youth, Mr. Stevenson acquired a vast fund of practical knowledge that has been of the greatest value to him in his business life. In this manner he

received instruction that it would have been almost impossible to have obtained elsewhere, as the patience and interest of a father's instruction cannot be matched by a paid teacher. He then entered Cornell University and remained in that institution for two years, a student of the agricultural course. His first employment as an engineer did not come until he had attained his majority, although so proficient had he become that at different times he was placed in full charge of an operation by his father. This was in the coal mining department of the Delaware, Lackawanna & Western, then engaged in the building of the Storrs branch and the construction of the Pancoast Colliery at Throop. He was next engaged by the Pennsylvania Coal Company when the old Pennsylvania Gravity Railroad from Scranton to Hawley was replaced by the present steam railroad, the Erie and Wyoming Valley. At the completion of this operation Mr. Stevenson journeyed to Arkansas to supervise some engineering work in that locality, and upon his return from the West devoted a portion of his time to conducting operations on his farm at Abington, making, as well, local land surveys and acting as engineer in the building of highways in the vicinity. It was not long, however, before he was once more entirely engaged in engineering, being employed at Hancock, New York, as resident engineer for the Ontario & Western Railroad, later entering the service of the Lackawanna Lumber Company in Potter county, Pennsylvania.

About 1892 Mr. Stevenson made Scranton his permanent home and there opened an office, his services being so greatly in demand that in a short time the pressure of work became too great for him to conduct the business single-handed with any degree of satisfaction, in consequence of which he formed a partnership with M. S. Knight. This connection continues to the present time, the firm of Stevenson & Knight having offices at 725-26-27 Connell Building, where they transact a large and lucrative business. The firm has gained a reputation for honorable and upright dealing, its name in connection with any operation being ample assurance that the work will be carried to completion with conscientious and able supervision. The other capacities in which Mr. Stevenson has been engaged in the practice of his profession are as engineer for the laying out of timber lands for the Almgordo Lumber Company in the Sacramento Mountains, New Mexico, and for a time he was in charge of the development of the tract owned by that company. Besides being one of the promoters, he was engineer in charge of the construction of the Northern Electric Street Railway, an enterprise he carried to a most successful close. While serving a term as surveyor of Lackawanna county, he introduced throughout the locality over which he had supervision the use of solid concrete floor bridges, which have been substituted for those of more ancient design all over the county, and also advocated reinforced concrete arch bridges, together with the low-riveted truss bridge with a solid concrete floor, of which many have been built in Lackawanna county. During his term of office there was no effective method of sprinkling the large court-house lawn until he installed the present system of stationary sprinklers all draining to one outlet.

Quite aside from his professional activities, Mr. Stevenson has become one of the leading agriculturalists along scientific lines in the county, a calling for which he was prepared by a course at Cornell University. One of the departments of his farm that has created country wide attention is that devoted to the raising of Holstein cattle, his herd being the only naturally hornless herd in the world. At his farm in Waverly his sons are conducting tests and making official records under the supervision of State College and the herd now hold the world's record for polled cattle of all ages. A junior three year old heifer has just completed the following records: 7 days, 593 lbs.



of milk, 26 lbs. of butter; 30 days, 2,472 lbs. of milk, 108 lbs. of butter; 60 days, 4,800 lbs. of milk, 204 lbs. of butter. These records are the highest ever produced in Pennsylvania by a junior three year old of any breed, and the highest in the world for a hornless animal. So wide spread is the interest demonstrated in this effort to raise blooded cattle devoid of horns that in October, 1913, W. J. Spillman, connected with the Department of Agriculture at Washington, visited Mr. Stevenson's farm to inspect the famous herd, and complimented Mr. Stevenson upon the practical and scientific value of his experiments. Another earnest of Mr. Stevenson's interest in affairs agricultural is his incumbency of the office of treasurer of the Lackawanna County Farm Bureau. Mr. Stevenson is a member of the American Institute of Mining Engineers, and of the Engineers Society of Northeastern Pennsylvania, also a life member of the Holstein Friesian Association of America, and president of the Pennsylvania Holstein Friesian Association.

In spite of his professional duties and agricultural experiments Mr. Stevenson still finds time to fulfill the many duties of good citizenship, and is highly esteemed both in business and private life.

---

#### GEORGE W. HORNBAKER

As a wholesale commission merchant, George W. Hornbaker has achieved his greatest success in business in Scranton, having entered that line after a varied career in other callings, in which he engaged at times as an employee and at other times independently. His parents were Joseph and Catherine (Hawk) Hornbaker. His father was a native of Luzerne county and his mother of Christmantown, New Jersey, a place near Blainstown. After their marriage they moved to Wayne county, later coming to Lackawanna county, Pennsylvania.

George W. Hornbaker was born in Luzerne county, now Lackawanna county, March 23, 1860. He was educated in the public schools of Lackawanna and Wayne counties, leaving school when he was fourteen years of age and engaging in farm labor, being so employed until 1880. In the spring of this year he came to Scranton in the employ of the Lackawanna Coal and Iron Company, working as blacksmith for about one year. On April 1, 1881, he began dealing in meat in Green Ridge, Scranton, continuing in this line of trade for fifteen years, then changing his line to general merchandise, selling his business at the end of two and one half years. He then became identified with the Scranton Cold Storage Plant, and there remained for eight years, when he established in his present business, that of wholesale commission dealer in butter and eggs, his place of business being No. 22 Lackawanna avenue, Scranton. He does a large business in these products, and has prospered materially. His only other business interest is as a stockholder in the Scranton Savings and Dime Bank. His political convictions are Republican, and he is a member of the Independent Order of Odd Fellows and the Benevolent and Protective Order of Elks, and in the Odd Fellows has passed all of the chairs. He belongs to the Green Ridge Presbyterian Church.

Mr. Hornbaker married, April 22, 1892, Lulu B., born in Factoryville, Pennsylvania, daughter of Cyrus B. and Ellen Gardner, of Factoryville, both deceased. Children of Mr. and Mrs. Hornbaker: Eleanor Catherine and Marian Virginia, both born in Scranton, the family home being at No. 1660 Adams avenue, Dunmore.

## THOMAS J. HUGHES

Although now retired from active business, Thomas J. Hughes is well-remembered in Dunmore, Pennsylvania, and his plumbing establishment at No. 129 Chestnut street, Dunmore, was one of the borough's institutions that, now departed, was once most familiar. Thomas J. Hughes is a son of John Hughes, a native of Ireland, who was reared to manhood and married in his homeland, afterward immigrating to the United States. Enlisting in the Union army, he served through the war between the states, his death occurring in Dunmore, Pennsylvania, when he was sixty-eight years of age. He was a member of St. Mary's Roman Catholic Church, of that place. He and his wife were the parents of three children, the only survivor of whom is Thomas J., of whom further.

Thomas J. Hughes, son of John Hughes, was born in Dunmore, Lackawanna county, Pennsylvania, in March, 1867, and there attended school. His education completed, he apprenticed himself to the plumber's trade, and after learning this was for eight years a gold prospector in the West, then returning to the place of his birth and establishing in the plumbing business. His beginning was assuredly humble, his cash capital, and he had few other assets, being eighty cents. The first call that he received after announcing that he would perform plumbing work of all kinds, was for a water trap. The market price of this article was seventy-five cents, and it was necessary to journey to Scranton to procure it. The price of the trap and the car-fare between Dunmore and Scranton completely exhausted his small funds, and he was compelled to walk back to Dunmore to install the trap. This was the starting point of his business, and it would have been difficult to find a lower place of departure upon a business career, but untiring application and earnest labor brought their inevitable rewards in patronage and prosperity, so that from that time until his retirement his business was a most flourishing one, his service to the public most excellent. Mr. Hughes is a director of the Fidelity Bank, of Dunmore; a charter member of the Smith Fire Company, and belongs to St. Mary's Roman Catholic Church. His career as a plumber in Dunmore was twenty-three years in duration, and during that time his working force ranged from one to four men.

He married Mary Mack, born at Niagara Falls, New York, their home being now at No. 228 Chestnut street, Dunmore.

---

 JESSE PALMER

The American life of this line of Palmers begins three years prior to the birth of Jesse Palmer, when his father, Charles Palmer, emigrated from his native country, England, and found residence in Hyde Park, Scranton, in 1865. Charles Palmer married Caroline House, and in 1878 moved to Wilkes-Barre, Pennsylvania, where he was employed in the mines. Charles and Caroline (House) Palmer were the parents of eight children.

Jesse Palmer, son of Charles and Caroline (House) Palmer, was born in Hyde Park, Scranton, Pennsylvania, July 29, 1868, and until he was eleven years of age was a student in the public schools. He then obtained employment as a slate picker in the colliery of J. H. Swoyer & Company, also W. G. Payne & Company, later being advanced to more responsible grades of mine labor. He subsequently became connected with the mining corps of the Lehigh Valley, the Chesapeake & Ohio, and the Wilkes-Barre & Eastern railroads, being engaged on construction work with these roads until September 17, 1894. On this date he became a member of the engineering corps of the

Pennsylvania Coal Company, a position that he filled until July, 1906, when he was promoted to the place of general foreman of the company's Colliery No. 6, at Pittston, Pennsylvania. He was the incumbent of this position for four years, in October, 1910, coming to Dunmore, Pennsylvania, as the district superintendent of the Pennsylvania Coal Company, his present status in the company's employ. He is a member of the Engineering Society of Northeastern Pennsylvania, and Valley Lodge, Free and Accepted Masons, at Pittston, Pennsylvania. Mr. Palmer's advance in the service of the Pennsylvania Coal Company can be attributed to no other fact than his capacity for measuring up to the magnitude of the task confronting him, and it has been this constant preparedness, this willingness and ability to face and to overcome unfamiliar conditions, that has placed him high in the company's esteem.

Mr. Palmer married, September 14, 1892, Bessie Crocker, daughter of William H. Crocker, and is the father of William, Harry, Margaret, Elba, and Frank, his two eldest sons employed in the engineering corps of the Pennsylvania Coal Company.

---

### JOHN McCRINDLE

At the present time junior member of the mercantile firm of Swift, McCrindle & Company, John McCrindle has been for thirty years a merchant of Lackawanna county, Pennsylvania, having been engaged in that line in Moosic and Scranton, the last-named place his present location. His has not always been a life of trade, for in young manhood he followed the occupation of his father, coal-mining. Should evidence be sought in his former or his present business relations, none would be found that would indicate aught but a merchant of principle and honor, one who founded his business upon fair-dealing and open transactions, and one who, after a career in business stretching over three decades, is looked up to in genuine regard by associates and friends as a gentleman of unblemished reputation.

John McCrindle was born in Glasgow, Scotland, January 17, 1866, son of Thomas and Mary McCrindle, who came to the United States when he was a boy of five years. His father was a coal miner. He died aged seventy years, his wife dying aged seventy-one years. The second of the eight children of this marriage was John McCrindle, who in his youth was a student in the public schools, in those institutions obtaining all of his scholastic training. Mining offered him his first employment, and he was so engaged until he was twenty-four years of age, when he formed a partnership with Mr. McMillan and established in general mercantile dealings in Moosic, the house trading as McCrindle & McMillan. This firm continued in prosperous circumstances for eleven years, when Mr. McCrindle became a member of the firm of T. H. Watts & Company, of Scranton, still retaining his interest in the Stevenson Hallstone Company the name having been changed to the corporated form of McCrindle & McMillan. After five and a half years he was one of the organizers of his present firm, Swift & McCrindle. For twelve and a half years this firm has been located at No. 440 Sixth avenue, Scranton, the store force numbering four, including the proprietors, and for a like period of time Mr. McCrindle has been a resident of Dunmore. Mr. McCrindle is a member of the local Board of Trade and is president of the Buffalo Creek Coal and Lumber Company, of Tennessee, this being his only other business relation. He fraternizes with the Masonic Order, and in religious belief is a Presbyterian. His political stand has ever been taken with the Republican party, and he held the postmastership of Moosic under Presidents Harrison, McKinley and Roosevelt, retiring from office under the last-named executive. While

in Moosic he was a member of the school board of that place. His standing as a merchant, his wide popularity, and his prominence as a government official of Moosic have made him one of the leading citizens of Dunmore, in whose welfare and advancement he has anxious interest and to which end he is ever ready to lend his aid.

Mr. McCrindle married Mary McMillan, and is the father of: Charles L.; Thomas W., deceased; James, deceased; J. Gordon; Marion M.; Jean.

---

#### FRANK C. WALLACE

The position of general foreman of the shops of the Wyoming Division of the Erie Railroad is a place requiring in its occupant an expert knowledge of mechanics, initiative and executive ability of no mean order, and above all the gift of managing and dealing with men in a manner that escapes resentment or friction of any kind. All of the above are found in Frank C. Wallace, the present incumbent of that position, and to them are added a strict sense of honor, a loyalty to employers unfailing, and an unrelaxing energy and application.

Frank C. Wallace, son of Charles R. and Oramma (Humphrey) Wallace, was born in Elmira, New York, August 7, 1879, and there lived until he was ten years of age, his parents then moving to Susquehanna, Pennsylvania, where his education was completed. He began his career as a bread winner by apprenticing himself to the machinist's trade in the machine shop at Susquehanna, where he remained from June, 1897, until September, 1900, passing the four following years as a draughtsman in Susquehanna and Meadville, Pennsylvania. From March, 1904, until July, 1905, he was employed by the Chicago & Alton Railroad at Bloomington, Illinois, and for the next year was foreman in the roundhouse at that place. In October, 1906, Mr. Wallace was appointed piece work inspector in the shops of the Erie Railroad at Buffalo, New York, holding that position until February, 1907, at which latter date he became assistant general foreman at Jersey City. He came to Dunmore as general foreman of the Wyoming Division of the same road, and there continues, ably directing the work of the shops, calling upon his wise judgment and knowledge to solve the problems, often vital and perplexing, that arise in the course of the day. He is both liked and respected by his associates, and between him and them exists a feeling of cordial friendship. Mr. Wallace married Margaret E. Elston, born in Elmira, New York, and resides at No. 118 Dudley street, Dunmore, Pennsylvania.

---

#### THOMAS F. HARRISON

After a varied business career in the Scranton district, Thomas F. Harrison, of Dunmore, Pennsylvania, of Irish descent, found his true calling and sphere of usefulness as master mechanic and foreman in the employ of the Railway Steel Spring Works, with which he has been connected for almost a quarter of a century. He is a son of James Harrison, a native of Ireland, who after his immigration to the United States settled in Hawley, Wayne county, Pennsylvania, where he was early employed on the canal, later moving to Scranton. In the latter city he was employed for the greater part of his residence there by the Pennsylvania Coal Company, dying in 1898, aged about fifty-four years, his wife having died seven years previously. He was a member of St. Peter's Cathedral. He married Catherine Clark, a native of Ireland, and had children, all but the last named born in Hawley, Pennsylvania, he in

Scranton: Patrick J., Mary E., Margaret A., Jennie E., Catherine B., James C., Thomas F., of whom further.

Thomas F. Harrison was born in Pine Brook, Scranton, Pennsylvania, December 16, 1875, and was reared in that city, there attending school. He began his business career as a messenger boy in the employ of the Western Union Telegraph Company, at which he worked for one year and a half, and after one year as a rivet heater he entered the service of the Boise Car Wheel Works. This plant was afterward sold and the Railway Steel Spring Works housed therein, in the employ of which concern Mr. Harrison has since remained, a period of twenty-three years, eight of which have been spent in the capacity of master mechanic and foreman, positions for which a long experience and an extensive practical knowledge of mechanics has ably fitted him. Mr. Harrison is a member of Scranton Council, Modern Woodmen of the World, Dunmore Commandery, Workers of the World, and Father McManus' Total Abstinence Beneficial Society, to which he has belonged for the past eight years. He was treasurer of the local order for three years, vice-president for two years, and president for two years, his fellow-members, upon his retirement from the president's chair, presenting him with a handsome gold watch in grateful acknowledgment of his competent leadership and as a remembrance of their universal esteem. He has been a Democrat all his life, and is now serving the third year of a six year term as a member of the school board of Dunmore, having been secretary of that body during his first year of membership and president during his second year.

Mr. Harrison married Anna T., born in Providence, Pennsylvania, daughter of Michael and Mary (Harrison) O'Malley, her father a stationary engineer in calling, for several years a member of the Scranton council. Children of Thomas F. and Anna T. (O'Malley) Harrison, all born in Dunmore, Pennsylvania: Catherine, Thomas L., Margaret, all attending school. The first child of Mr. and Mrs. Harrison died in infancy.

---

#### WILLIAM W. INGLIS

The record of William W. Inglis is one that, fully narrated, illustrates well the beneficial results of persistent application and concentration upon one line of action, the advisability of devotion to one end, the constant presence of that trait in his business career having placed him in his present important position as general manager to the Pennsylvania Coal Company, the Hillside Coal and Iron Company, and the New York, Susquehanna, and Western Coal Company. As a youth of fourteen years he entered the employ of the Hillside Coal and Iron Company, having determined upon business of that nature as his life work, and during the years from 1885 to 1913 rose in the service of that company from office boy to general manager. His willing and able performance of the duties that were entrusted to him in one position constantly led to the reposing of still greater responsibility until he has reached the office of general manager of these allied companies. Energy in labor and force of character are the agents that have opened for him the door of opportunity through which he has passed into constantly enlarging fields of service, and increasing trust and duty.

William W. Inglis was born on Jefferson avenue, Scranton, Pennsylvania, January 19, 1871, and was educated in the public schools of his native city, at the age of fourteen years becoming an office boy in the employ of the Hillside Coal and Iron Company. He has served through various grades of employment in the service of this company, and in February, 1913, was elevated to the general managership of the company, and the same position with the

Pennsylvania Coal Company and the New York, Susquehanna, and Western Coal Company. Mr. Inglis is a member of the board of directors of the Lincoln Trust Company, holding the same position in the Scranton Young Men's Christian Association, and belongs to the Scranton Club, of Scranton, and the Engineers Society of Northeastern Pennsylvania. His lodge is the Peter Williamson, No. 323, F. and A. M., and he has attained the thirty-second degree Scottish Rite, belonging to Irem Temple, Mystic Shrine. He is a trustee of the First Presbyterian Church, and politically is a Republican sympathizer.

Mr. Inglis married Gertrude Jayne, born in Scranton, daughter of John and Hettie Kennedy, and is the father of John, born in 1895, and Mary, born in 1898.

---

#### WALTER H. DAVIDSON

Coming from his Scotland home after becoming a worker in wood in that country, Walter H. Davidson has since his twenty-seventh year been a resident of the United States, living for all but one year of that time in the Scranton district and for the past quarter of a century in Dunmore. He is a son of James and Joanna (Lainge) Davidson, his parents likewise natives of Scotland, the parents of five children. James Davidson died aged sixty-seven years, his wife aged seventy-seven years.

Walter H. Davidson was born in Rocksby, Scotland, May 3, 1855. He was reared in Peeblesshire, where he lived from his fourth until his sixteenth year, and there learned the trade of carpenter. In 1882 he immigrated to the United States, settling first in Boston, Massachusetts, where he remained for one year, at the end of that time coming to Scranton, where he obtained employment at his trade. He subsequently moved to Dunmore, Pennsylvania, and was there engaged at his trade until his retirement. In addition to being skilled in the constructive work of his trade, such as house-building, Mr. Davidson is master of the cabinet-maker's art and an accomplished worker in hard woods, specimens of his work showing delicacy and fineness of execution. Mr. Davidson is an Independent in political action, never entering the public service. While no more loyal citizen of the United States than he could be found, he retains a deep and reverential love for the country of his birth, and visited Scotland in 1911.

Mr. Davidson married, in Scotland, Jane, born in Peeblesshire, Scotland, daughter of Wildon and Elizabeth (Scott) Whitson, and has children: James, a resident of Buffalo, New York; Frederick, an engineer in the employ of the Erie Railroad; Elizabeth Scott, employed by the International Correspondence Schools; Andrew Edgar, a fireman on the Erie Railroad; Benjamin H., met an accidental death when sixteen years of age.

---

#### ALBERT F. WESTPFAHL

Proprietor of the business conceived and founded by his father, the late John Westpfahl, Albert F. Westpfahl is one of the popular and prominent merchants of the city of Scranton. He has fostered the welfare of his concern, and by his assiduous application has increased its prosperity, widened its scope, and strengthened the firm foundation laid by the elder Westpfahl. John Westpfahl, father of Albert F. Westpfahl, was born in Germany, and in 1863 came to the United States. In his native land he had watched with interest and strong sympathy the civil strife in that country and upon his arrival immediately took steps for enlistment in the Union army, serving for nine months until wounded by a bursting shell. He came to Scranton after re-



*A. J. Kestel*





ceiving his discharge and was employed in a blacksmith's shop until 1886, in that year opening a grocery store at Nos. 629-631 Pittston avenue, and was actively engaged until his death, November 13, 1903. At his death his business was established, was of vigorous growth, and gave promise of the prosperity it has since attained. He married Augusta Rabe. Children: Amelia; Charles W., assistant city clerk of the city of Scranton; Wanda, married Theodore Bauschman; Albert F., of whom further.

Albert F. Westpfahl was born in Scranton, Pennsylvania, September 25, 1870. He attended the public schools of his native city and at the completion of his studies entered his father's store. Here he was employed until the death of his father when he succeeded to the ownership of the business, which he has conducted since. He is also interested in the Rice Grocery Company, a concern transacting one of the largest wholesale grocery businesses in the city, and Mr. Westpfahl is president of this corporation. His pleasing personal qualities have gained him popularity in his native city, and he is universally regarded as a citizen of public spirit and one who heads a business that is a credit to Scranton institutions. Fraternally he is also prominent, belonging to Shiller Lodge, No. 345, F. and A. M., holding the thirty-second degree in the Masonic Order and membership in the Nobles of the Mystic Shrine; the Knights of Malta; the Patriotic Order Sons of America; the Junger Mannerchor; the Liederkrantz; the Saengerbunde; the Royal Arcanum; the Scranton Athletic Club; the South Side Republican Club; and the Deutsch-Amerikanischer Bund. His only other business interest, excepting the presidency of the Rice Wholesale Grocery Company, is as a member of the board of directors of the South Side Bank. His church, of which his wife also is a member, is the First German Presbyterian.

Mr. Westpfahl married, April 15, 1897, Mary E., daughter of Charles Shelp, of Hawley, Pennsylvania, and is the father of three children: Frederick, John, Frank.

---

### JOHN H. KEAST

The association begun with the Pennsylvania Coal Company thirty-two years since by John H. Keast exists at the present time, although the relation has been broken by a term of service with the Delaware, Lackawanna & Western Railroad Company. In both instances his duties have been connected with stone-cutting and masonry, his present capacity with the first-named company being that of superintendent of masonry. Mr. Keast is a native of Cornwall, England, and it was there that his father, John Keast, was born. John Keast was a stone-cutter by trade and for twenty-five years was employed as foreman on work of that nature in the homeland. He married Jane Polgrean, who died in 1892, aged seventy-two years, John Keast marrying a second time.

John H. Keast, son of John and Jane (Polgrean) Keast, was born May 11, 1860, and resided in his native country until he was twenty-two years of age, when, with his wife, he came to the United States. Making Scranton his first stopping place, he was for a time employed in the Jermyn mines at Priceburg, now Dickson City. He had been there working for but a short time when an accident, bringing death to several, occurred, and Mr. Keast, learning of the frequency of these happenings, which modern engineering has greatly lessened, abandoned mine labor. Until March, 1882, a period of only a month or two, he engaged in stone cutting on the Lackawanna County Court House then in the course of construction, afterward working at Winton Bridge until a strike ended his employment at that place. Returning to work on the Court House, the construction of that edifice gave him occupation for two seasons,

after which he was identified with Rice and Warner, contractors, and Burke Brothers, in the order named, stone cutting being then his principal line. In April, 1885, he formed a connection with the Pennsylvania Coal Company, as stone cutter, which ceased when he engaged under D. Y. Williams as gang foreman and mason for the Delaware, Lackawanna & Western Railroad Company. In 1896 Mr. Keast began the association that continues to the present time with the Pennsylvania Coal Company, becoming a mason under Superintendent of Masonry Patrick Blewitt, and worked as a mason until a serious illness compelled a ten months' retirement. With health and vigor restored he returned to his work, and until February, 1911, was employed as gang foreman, at that date being raised to the position of superintendent of masonry and concrete construction. His territory covers three counties, and he has upon an average nine gangs of men engaged on work under his direction, whose labor he directs, through foremen, with strong ability and the assurance of knowledge. Mr. Keast is a member of St. Mark's Episcopal Church, holding membership in the vestry, and for the past fifteen years has been superintendent of the Sunday school connected with that church, giving to his work as its head the devoted service that, in the business world, has gained him responsible position. He is a member of the Ancient Order of Foresters has been through all the chairs and for fourteen years served as secretary. His political faith is Republican.

Mr. Keast married, December 18, 1881, Mary Elizabeth Angwin, born in Cornwall, England, daughter of John and Frances (Toman) Angwin, whose mother died aged thirty-two years. John Angwin and his children came to the United States about 1869, after the death of his wife, and engaged in coal mining in the Jermyrn mines. Children of John H. and Mary Elizabeth (Angwin) Keast: Frances Jane, Helen Mabel, Annie, died aged two years; John Henry (Harry), Maude Elizabeth, Sarah Mildred, Edward Charles.

---

#### THOMAS J. McNULTY

Among those of Dunmore's citizens whose part in the development of the vast coal deposits which are one of the greatest sources of the locality's wealth has been a practical one, who has wrought from Nature her valuable treasure with his muscles and hands, is Thomas J. McNulty, who has been a miner in that region since he was twelve years of age. A native of Dunmore, that was the home of his parents, James and Susan (Teevan) McNulty, both deceased. James McNulty was employed at outside work in connection with coal mining, and for ten years was a member of the borough council of Dunmore, to which he had been elected as a Democrat. His death occurred when he was seventy-eight years of age, his wife dying in 1866.

Thomas J. McNulty, son of James and Susan (Teevan) McNulty, was born in Dunmore, Pennsylvania, March 14, 1864, and there attended the public schools until he was twelve years of age, when he obtained mine employment and has so since continued. He is a member of the Catholic Mutual Benefit Association, the Ancient Order of Hibernians, the Workers of the World, and Emerald Temperance Society. A Roman Catholic in religion, he belongs to St. Mary's Church, and has always adhered to Democratic principles in politics. He is now serving in the third year of a six year term as member of the Dunmore school board. His residence is the place of his birth at No. 1007 East Drinker street, Dunmore. Mr. McNulty married Mary, daughter of Michael and Sarah Golden, of Dunmore, both deceased, and is the father of Leo, Florence, Joseph, all living at home.

## ARTHUR W. CLOSE

The name of Close is one that will be long and lovingly remembered in Dunmore, Pennsylvania, through the life of Rev. J. Edward Close, deceased, who was pastor of the Presbyterian church of that place, in which position he not only endeared himself to the hearts of his parishioners but firmly entrenched himself in the memory of the entire community. He was a gentleman of all good works, and never did man find happier direction in the choice of a calling than did he when he entered the ministry, for in service to his fellows he found the deepest joy.

Arthur W. Close, son of Rev. J. Edward and his wife, Mary E. (Hooper) Close, was born in Auburn, New York, March 29, 1875. As a boy he obtained the greater part of his general education in the schools at Pittsford, Monroe county, New York, at the age of thirteen years accompanying his parents to Dunmore, Pennsylvania. In this latter place he was for two years a student in the high school and for two years attended night school in Scranton, without completing the second term. He entered the business world as private secretary to the general manager of the Pennsylvania Coal Company, George B. Smith, an office he held for ten years, during which time he also served under John Smith. At the expiration of this time he accepted a position as secretary to Postmaster Ripple, of Scranton, and afterward was associated with the government postal service in the Scranton post office as cashier, an office he held for five years, assistant postmaster, and after the death of Postmaster D. W. Powell he became acting assistant postmaster. Resigning from the government employ Mr. Close was for one year cashier of R. E. Weeks Company, then being elevated to the office of treasurer, which he now holds, also being a member of the board of directors of the concern. Mr. Close holds like positions in the R. E. Weeks Realty Company, and in the management of the finances of these companies has proven himself reliable, able and trustworthy. He is a member of Dunmore Lodge, Independent Order of Odd Fellows, having filled all the chairs, and in political belief is a Republican. He has been trustee and treasurer of the Presbyterian church, of Dunmore, of which his father was a former pastor.

Mr. Close married Edith Wert, born in Dunmore, Pennsylvania, daughter of Elnathan E. and Jane (McCullough) Wert, her father a veteran of the Civil War, her mother a sister of John McCullough, the renowned actor. Mr. and Mrs. Close are the parents of John Edward, Willis, Elizabeth and Jane. The family home is at No. 418 Elm street.

---

IRVIN C. MILLER

In business connected with the International Correspondence Schools, of Scranton, Irvin C. Miller is a resident of Dunmore, Pennsylvania, his birthplace, and prominent in the public life of that borough through his service in its civil administration as auditor and controller. He is the first incumbent of this latter office, which in 1913 was created from that of auditor. In the year 1914 he entered upon a four year term in the capacity of controller.

Irvin C. Miller is a son of Orville J. Miller, his father a native of Wayne county, Pennsylvania, where he was reared. Orville J. Miller has for the past thirty-five years served the Delaware, Lackawanna & Western Railroad Company in the capacity of conductor, his long record a continuous repetition of loyalty, fidelity and competence. He married Mary, born in Dunmore, Pennsylvania, daughter of Archibald McAllister, and had eleven children.

Irvin C. Miller, third of the eleven children of Orville J. and Mary (Mc-

Allister) Miller, was born in Dunmore, Lackawanna county, Pennsylvania, March 29, 1877. He attended the public schools of his birth-place and graduated, then graduated from the Scranton Business College, after which he obtained a position with the International Correspondence Schools, of Scranton, as stenographer. He resigned from this employ to accept a similar place with the Delaware, Lackawanna & Western Railroad Company, subsequently returning to the International Correspondence Schools as clerk in the general correspondence department, his present capacity. He is a trusted employee, able and willing, and is thorough master of the efficient routine of his department.

Mr. Miller's political convictions are Democratic, and it was as the candidate of this party that he was elected to the office of borough auditor of Dunmore, his administration of his duties so entirely satisfactory that upon the creation of the new office of controller in 1913, Mr. Miller was elected to fill that place for a term of four years. He is a member of the Dunmore Temperance Society, the Young Men's Institute, the International Correspondence Schools Association, and St. Mary's Roman Catholic Church.

Mr. Miller married, in September, 1910, Margaret, daughter of Thomas J. Brown, a contractor of Plymouth, Pennsylvania, and is the father of Marian and Tom. The family home is at No. 1531 Electric street, Dunmore.

---

#### EDWARD P. MOORE

Edward P. Moore, of Dunmore, Pennsylvania, now serving in his third term as a member of the school board of that borough, is a native of Lackawanna county, having been born in Scranton, September 30, 1872. He has been a resident of Dunmore since he was six years old, and in the public schools of that place obtained the major part of his education, from his eighth until his thirteenth year being employed in the coal mines of the region during his vacations from school work. At the latter age he left school and devoted himself to mine employment, in which he has continued, working in the mines at this time (1914). He is a member of the Ancient Order of Hibernians, the Young Men's Temperance Institute, the Industrial Workers of the World, the Miners' Union, and is a charter member of the Eclipse Hose Company. His church is St. Mary's Roman Catholic. Mr. Moore has been thrice a member of the Dunmore school board, and in 1912 was elected for a six year term.

Mr. Moore married Catherine, daughter of John and Mary (McMunn) Murphy, of Dunmore, Pennsylvania, and has two children, Genevieve and Edward. The family home is at No. 424 Bloom street, Dunmore.

---

#### JOHN MELLODY

The ancestry of this line of Mellodys is Irish, one of the present day representatives of the family being John Melody, of Dunmore, Pennsylvania. He is a son of James Melody, a native of Ireland, and came to the United States when a young man, and soon after his arrival settled in the Scranton district, building the first house erected on "Johnson's Patch" by a private individual, although the company developing the coal resources of the locality had previously built numerous dwellings for their employees. James Melody was the first to open a chamber for operations in "Johnson's Patch," and was a miner all of his life, retiring from active labor when sixty years of age, his death occurring five years afterward. His manner of life was simple and his savings amounted to a comfortable fortune, from which he frequently drew

for the assistance of a neighbor in trouble or less fortunate than he, holding the universal regard of all and the undying gratitude of the many whom he was able to help conquer unexpected adversity. He married, in Scranton, Bridget, born in Ireland, daughter of Dominick Dempsey, and with her was a member of St. Paul's Roman Catholic Church, he a Democrat in political action. James and Bridget (Dempsey) Mellody were the parents of nine children.

John Mellody, third child of James and Bridget (Dempsey) Mellody, was born in Dunmore, Pennsylvania, March 23, 1880, and there passed his youth, obtaining his education in the public schools, remaining in the family home until his marriage. He is at the present time a salesman in the employ of the Atlantic Oil Refining Company, and since his connection with that firm in the capacity of salesman has been successful, possessing many of the qualities that make for excellent salesmanship, the greatest of which he has in large measure, a willingness and desire for hard and persistent effort. In December, 1913, as a Democratic candidate, he was elected to membership in the Dunmore school board, and since that time has held a seat in that body. The political party that has ever claimed his support is the Democratic, and he is a member of the Modern Woodmen of America, the Ancient Order of Hibernians, the Total Abstinence Beneficial Society, and a charter member of O. S. Johnson Hose Company, No. 7. His church is St. Mary's Roman Catholic.

Mr. Mellody married, June 19, 1907, Mary Ursula Davitt, born in Dunmore, Pennsylvania, daughter of James H. and Mary (Kane) Davitt. James H. Davitt, a native of Ireland, was reared in England, and after coming to the United States was married, his death occurring in 1911. He was the proprietor of the first bottling establishment in Dunmore, and prospered in every business relation. He was a Democrat in politics, and he and his family were members of the Roman Catholic church. He was the father of eleven children, seven of whom are now living, his widow residing at the corner of Webster and Drinker streets, Dunmore. Mr. Mellody, since his marriage, has lived at No. 437 West Drinker street, Dunmore. They have one son, James.

---

#### CARL W. F. NEUFFER

During the two decades that he has been associated with the Pennsylvania Coal Company, Carl W. F. Neuffer, of Dunmore, Pennsylvania, has risen steadily from a humble situation to a position of responsibility in the mining engineering department of that concern. He came to the Pennsylvania Coal Company fully prepared for a career of usefulness, and in that service has found the reward of application, industry, and fidelity. He is a son of Charles D. and Anna (Weber) Neuffer, his father having come to Scranton from New York in 1857, in the former place accepting a position as clerk with the Lackawanna Iron Company. In 1862 he established a gentlemen's furnishing store on Lackawanna avenue, where he was a well-known merchant for forty-two years, his death occurring when he was sixty-eight years of age. He saw service in the Union army during the war between the states, and was a member of the Grand Army of the Republic. His devotion to business was matched only by his ceaseless endeavors in church work, his membership being in the Presbyterian church, and he fraternized with the Independent Order of Odd Fellows and the Improved Order of Red Men. His wife died aged sixty-three years, the mother of seven children, of whom Carl W. F. and four sisters survive.

Carl W. F. Neuffer, son of Charles D. and Anna (Weber) Neuffer, was born on Lackawanna avenue, Scranton, Pennsylvania, July 29, 1872, and after study in the public schools which included a high school course he entered Le-

high University, South Bethlehem, Pennsylvania, whence he was graduated C. E. in 1894, four years after his graduation from the Scranton High School. He immediately became employed by the Pennsylvania Coal Company, and after spending considerable time in minor positions, familiarizing himself with the work of the company and the methods used, he was promoted, in June, 1901, to the rank of mining engineer. From this time his rise was rapid, and in June, 1906, he was made district superintendent, one year later mining inspector, and in July, 1909, a member of the mining engineering department, his present rank. Mr. Neuffer holds a similar position with the Hillside Coal and Iron Company. Since 1902 he has been a member of the Engineering Society of Northeastern Pennsylvania; a Republican in politics, belongs to the Episcopal church, and also the Lackawanna Historical Society.

He married Almira, born in Wilkes-Barre, Pennsylvania, daughter of Francis A. and Julia (Lathrop) Ramsay, both deceased. Mr. and Mrs. Neuffer's children are: Louise and Julia. Mrs. Neuffer, tracing her ancestry to colonial days, holds membership in the Daughters of the American Revolution.

---

#### CHARLES H. STEVENS

Both of the line of Stevens mentioned in this record are natives of Dunmore, Pennsylvania, they being Charles H. and his father, Fred D. Stevens. The former is at the present time connected with the coal mining industry of the locality as weigh master and coal inspector for the Nay Aug Coal Company, while the latter was a produce dealer of Scranton. Fred D. Stevens was born February 26, 1858, died January 7, 1902. Politically a staunch adherent to Republican principles, his church was the Methodist Episcopal. He married, in Newton, New Jersey, Elsie J. Space, who after his death married a second time, her husband being C. H. Biesecker, her residence at Newton, New Jersey. Mr. and Mrs. Stevens were the parents of but one child, Charles H.

Charles H. Stevens was born October 20, 1881, and until he was fifteen years of age attended the public schools of his birth-place. His first position in the business world was as shipping clerk in the employ of G. B. Miller & Company, after which he was a clerk in his father's produce establishment on Lackawanna avenue. He then became associated with the Pennsylvania Coal Company as inspector of coal and extra weigh master, remaining with that concern until June, 1913, when he resigned to accept the positions of weigh master and coal inspector with the Nay Aug Coal Company, his present employers, in which company he holds a position of importance and responsibility, and enjoys the confidence and favor of his employers. Mr. Stevens' home is at No. 125 West Drinker street, Dunmore. He fraternizes with the Masonic Order, the Independent Order of Odd Fellows, and the Knights of Pythias. In politics he is a Republican, and he holds membership in the Methodist Episcopal church.

Mr. Stevens married, September 26, 1907, Elizabeth Winters, born in Dunmore, Pennsylvania, daughter of John Winters, a conductor on the Delaware, Lackawanna & Western Railroad, in which employment he met an accidental death. Mr. and Mrs. Stevens are the parents of one daughter, Jane Elizabeth.

---

#### HAROLD S. BRIGGS

Musical interests in the city of Scranton have an accomplished and able exponent in the person of Harold S. Briggs. Trained by the most renowned teachers of this and European countries, a teacher whose skill and talent make him the admiration of his pupils, an artist with a reputation of national scope.





Harold S. Briggs.



Scranton's musical coterie has received a valuable addition through his eight years of residence in the city. His family is an old one in this country, his grandfather, Nathan Briggs, having been a nephew of George Nathan Briggs, a former governor of the state of Massachusetts. Nathan Briggs had three sons: William P., of whom further; Oscar; George.

(II) William P. Briggs, son of Nathan Briggs, was born in 1851, died in 1910. He was vice-president and general manager of a firm manufacturing and selling farm implements, an occupation in which he continued until just prior to his death. He married Ella Stewart, and had children: Rae, deceased; Clare, a cartoonist on the staff of the New York Tribune; George Nathan, managing editor of *Efficiency*, a business magazine published in Chicago, Illinois; Glen William, a mid-shipman in the United States navy, stationed at Annapolis.

(III) Harold S. Briggs, son of William P. and Ella (Stewart) Briggs, was born at Reedsburg, Wisconsin, October 3, 1882. He was educated in the public schools of Lincoln, Nebraska, attending the high school of that city. Adopting music as his life work he studied in this country and abroad, taking a special course at Columbia University and supplementing this with two years in Berlin, Germany. Since engaging in professional work in the United States Mr. Briggs has thrice traveled to the musical and art centres of the Old World in order to pursue his studies under the direction of the best masters. For six years he was in New York City, and during that time "coached" for the celebrated Francis Fischer Powers of that city, also teaching in Carnegie Music Hall, and for four years conducted a summer music school in Kansas City. In 1906 Mr. Briggs took up his residence in Scranton, and for some time was a piano teacher in The Allen-Freeman Studios, since which time he has given instructions privately in a studio maintained by himself. Mr. Briggs is a no less skillful performer upon the pipe-organ than upon the piano, and at the present time is organist in the Elm Park Methodist Episcopal Church. He is frequently heard at concerts and recitals and his name upon a programme is an assurance of at least one number enjoyable to those taking pleasure in the work of a proficient artist. He holds the works of the greatest composers at his fingers' ends, his faultless rendition of the most difficult compositions revealing the beauty placed therein by the masters, which would be lost in a less sympathetic interpretation. Of him all has been said when it is stated that up to this period he has devoted himself solely to his art, that to it he has given the best of himself, his talent, and his time, receiving in return for this complete surrender to his muse the gratification and deep satisfaction that can only come to those who have sounded the wells of the works of master musicians, have imbibed their sweetness and charm, and have led others to these discoveries, always old yet ever new.

---

#### CHARLES E. WENZEL

Among the merchants of Scranton, whose business is to provide for the comfort and convenience of the residents of the city the firm of Wolf & Wenzel, plumbers, tinnern and heating contractors, holds a prominent place. Engaged in the line of business indispensable in modern days, their administration of their affairs and their strict application of principles of fair dealing has been such as to gain the confidence and support of a generous patronage.

Conrad Wenzel, father of Charles E. Wenzel, was born in Germany, June 29, 1835, died in Scranton, Pennsylvania, September 25, 1905. He resided in Grossallmerode, Hessen-Cassel, from whence he emigrated to this country, April 25, 1871, arriving in New York, May 13, 1871, and took up his residence

in Scranton, Pennsylvania, where he spent the remainder of his days. For the first three months after his arrival in that city he was employed in a blacksmith's shop. Gathering in this time a knowledge of American ways of transacting business, he established a hardware store and continued in successful operation until 1877, when he moved to a building on Lackawanna avenue, the site now occupied by the freight house of the Central Railroad of New Jersey. Here he opened a hotel and was proprietor of the same until 1881, in that year establishing a brewery at Dunmore, discontinuing its operation after two years. In 1883 he returned to the scene of his initial business venture and opened a tinner's shop in the basement of a building occupied by the Independent Order of Odd Fellows, and was there engaged in business for two years, then moved to No. 712 West Lackawanna avenue, building up a sound and sturdy business by his indefatigable energy and untiring industry. In 1896 he retired from active business pursuits and so lived until his death. His fraternal order was the Independent Order of Odd Fellows, and he was a member of and for some years president of the Scranton Liederkrantz. He married Louise C. Rueppel, born January 4, 1835, died January 14, 1908. Their children were: Ida, Emma, Charles E., of whom further; Gustave, Victor A., Siebert E., Emilia and Wilhelmina, who died in infancy.

Charles E. Wenzel, son of Conrad and Louise C. (Rueppel) Wenzel, was born in Germany, December 2, 1866. He was brought to this country by his parents when five years of age, and attended the public schools of Scranton until he was fourteen years of age. He then worked about a year in the Everhart Brass Works, at the brass finishing trade, and then worked with his father at the tinsmith trade. Although not having the advantage of serving an apprenticeship, after working with his father for the short period of five months, the elder Mr. Wenzel fell from a ladder and broke his leg, and Charles E. being the eldest of four boys, he was compelled to assume charge of the business, in which capacity he was quite successful, although owing to lack of experience he was compelled to work night and day, also on Sundays, in order to keep abreast of his work. Fortunately for him the instruction he had received up to that time had been much more interested and thorough than that ordinarily accorded a tyro at a trade, and he was enabled to assume the burden of responsibility thus laid upon him, making estimates, ordering material, employing assistants, and attending to all the minute details falling to the lot of a proprietor. For several years Charles E. Wenzel worked every night until midnight, and with a portion of the money received therefrom he took a course in Hinman's Business College, and this he always considered one of his greatest assets. He continued to work and assist in managing his father's business until his father's retirement, and on April 1, 1896, he formed a partnership with Joseph Wolf under the name of Wolf & Wenzel, and succeeded the elder Mr. Wenzel in the business, which has been a decided success owing to the fact that both are practical workmen, always cater to high grade work, using the best material, and give each and every contract their own personal attention. Among the many plumbing jobs performed in the city of Scranton, installed and superintended by Mr. Wenzel are the following: The First National Bank, the Dime Deposit Bank, the Scranton Textile Company, the Derry Silk Mill, E. Robinson's Sons, the T. M. Miller Casket Company, Schools Nos. 14, 15, 42, the Scranton House, Century Club, the beautiful residences of Miss Helen Winton, August Robinson, Samuel Frank, J. G. Hufnagel, Frank Becker, Thomas E. Jones, the Jermyn and Carter Apartment Houses, German Presbyterian Church and many others too numerous to mention.

Mr. Wenzel, as well as his parents and family, have always borne the best reputation and have been considered among the prominent and foremost



Chas. E. Kengel.



Germans in the city of Scranton, always taking an active part in all German undertakings. Mr. Wenzel is a thirty-second degree Mason, being a member of Schiller Lodge, No. 345, F. and A. M.; Keystone Consistory, Sovereign Princes of the Royal Secret, and Irem Temple, Ancient Arabic Order Nobles of the Mystic Shrine. He is also a member of Schlaraffia Scrantonia and the Scranton Liederkrantz, in the latter organization having been a prominent member for the past twenty-seven years, and has held every position of trust and honor within the gift of its members repeatedly.

Mr. Wenzel married, in 1889, Frances Laderer, born November 26, 1868. Their children: Ida G., born February 18, 1890, and Carl Victor, born October 4, 1891. Mrs. Wenzel died April 9, 1913.

---

### SAMUEL J. FUHRMAN

Three generations of this branch of the Fuhrman family have resided in the United States, coming from Germany, where the family had long been seated in comfortable circumstances. Among the heirlooms brought from the fatherland is a massive mahogany table, now the property of Samuel J. Fuhrman, once the cherished possession of his great-grandfather, one hundred and seventy-one years ago. Another memento, highly prized, of a later day but dramatic in significance is the gun and sword of a Confederate soldier with whom Jacob S. Fuhrman, father of Samuel J., engaged in a death struggle, resulting in the death of one and the severe wounding of the victor. Two generations of the family have resided in Scranton, Jacob S. Fuhrman coming in 1866; a skilled worker in copper and other metals, he left many monuments of his handicraft, notably the copper crosses on the Cathedral, corner of Wyoming avenue and Linden street, Scranton, and the spire ornaments on the chapel of the Archbald Church. Probably no two men of the city have had a more varied or useful connection with its lesser activities than Jacob S. and Samuel J. Fuhrman, father and son, both artisans and capable business men.

Samuel J. Fuhrman was born in New York City, October 21, 1849, son of Jacob S. Fuhrman, and grandson of Jacob Henry Fuhrman, both of German birth. Jacob Henry Fuhrman with his wife Mary came from Germany to the United States at about the same time as their son, Jacob S., located in New York, where both died, leaving issue: Jacob S., Bertha, Jeanette, Hannah, all deceased.

Jacob S. Fuhrman was born in Germany, in 1828, and in youth came to the United States. He settled in New York City where he followed his trade of tin and coppersmith, owning a hardware store and shop on Houston street. He continued in business successfully until the Civil War broke out, then with a patriotic zeal unlooked for in an alien he gave up his business and offered his services as a soldier. He was commissioned first lieutenant, Sixth Regiment New York Militia, and spent his first term of enlistment, four months, principally at Harper's Ferry, Virginia. After being mustered out in February, he re-enlisted in the Sixty-sixth New York Regiment Volunteers, recruited by Colonel Pinckney in New York City, and again went to the front as captain of Company E, the flag company, then numbering one hundred and thirty-two men and officers. He was a participant in many of the hard fought battles of the war preceding Gettysburg, Bull Run, Antietam, Seven Days and others. In an encounter with the Confederates on the day before the battle of Gettysburg began, he was savagely attacked and wounded by a bayonet thrust but came off victorious, with his enemy's weapons as souvenirs. After recovering from his injuries, Captain Fuhrman was honorably discharged and returned

to New York, entering the employ of Walker & Connor on Water street. Here he made the acquaintance of Joseph Scranton, at whose solicitation he came to Scranton, November 7, 1866. He was engaged at his trade, tin and copper-smith, and in merchandising until his death, May 5, 1877. On first coming to the city he was manager of the tinning department of the Lackawanna Iron and Coal Company, continuing three years. He was then with the firm of Connell & Batten on Lackawanna avenue two years, then with Lynott Brothers (now T. F. Lynott & Company), later with Hunt & Connell for five years. During these years he erected many enduring monuments to his skill as a coppersmith and installed the copper and tinwork in many large buildings and breweries where copper pipes and fixtures were a necessity. After five years with Hunt & Connell he engaged in business for himself, opening a store for the wholesale and retail sale of notions, tents, awnings and kindred goods, continuing until his death. He married Eliza, daughter of Seligman Bideman, and had issue: Samuel J., see forward; Hannah, deceased; Mary, deceased; Caroline, married Herman Abrams, of Brooklyn; Solomon, a resident of Scranton; David; Jennie, a resident of Brooklyn, New York.

Samuel J. Fuhrman obtained his early education in the public schools of New York City, which he attended until thirteen years of age. Since then his education has progressed in the great university of experience, from which the real man never graduates until he lies down for his long sleep. At age of thirteen he became a wage earner and from that day has made his own path in the world, through storm and sunshine, often hard buffeted by adverse fortune, but now at age of sixty-four years can safely rest in the consciousness that he has fought well life's battle and gained a well earned success. His first employment was in the printing house of Fair, White & Ross, New York. There he worked during the regular hours, then until 12 o'clock at night on the New York Weekly. When the firm of Fair, White & Ross dissolved some years later, Mr. Ross and Mr. Fuhrman became employees of the lithographing and printing firm of Gray & Green, with whom he remained until 1863, when he was appointed to a clerkship in the office of the provost marshal at Washington, D. C., remaining until December 23, 1865. The following year he joined his father in Scranton and was there first employed by J. A. Scranton on *The Republican*, then published at No. 324 Lackawanna avenue. Two years later he abandoned the printer's trade, spending the ensuing three years in the employ of the Delaware, Lackawanna & Western Railroad. The next three years were spent with Slockbower & Son in the market, then he joined his father in his tent and awning business, continuing his father's assistant until the latter's death in 1877, then succeeded him as proprietor, conducting his operations in the same loft for thirty-four years. To the business as originally conducted he has added many features that have brought him unusual prominence far and near. In the line of electrical display, signs and decorations he is unsurpassed. In proof thereof is the result of the competition in building decoration at Buffalo, July 10-15, 1905, in honor of the convention of the Benevolent and Protective Order of Elks. Seven prizes were offered, of which Mr. Fuhrman won four: first \$150, third \$100, sixth \$30, seventh \$20. The winning buildings he decorated were: The D. S. Morgan block, the Ohio Hotel, the Desbecker & Company store and the C. A. Weed & Son store. A further evidence of his genius is the fact that since 1900 he has annually decorated Cornell University building for the celebration of "Commencement Week." He has patented camp, awning and automobile devices that have met with great favor; a camp and automobile water bucket; a roll awning and one that requires no frame. With his decorative special and regular lines, Mr. Fuhrman has built up a large and profitable business, all over the United States

and other countries, of which he is the active and capable head. Mr. Fuhrman is a member of the Benevolent and Protective Order of Elks; Knights of the Maccabees, Scranton Athletic Association; Junger Mannerchor; Leiderkranz, Electricians Union. He was an active member of Scranton Volunteer Fire Department and for many years was a member of the Nay Aug Hose Company. He is a Republican in politics, and a member of St. Luke's Episcopal Church.

Mr. Fuhrman married (first) Ida, daughter of Whitney Westcott; children: Jacob Raymond, Mary, George. He married (second) Gertrude, daughter of Willett Gearhart, the latter a veteran of Company G., One Hundred and Seventeenth Regiment Pennsylvania Cavalry, died in 1901.

### JOHN S. DUCKWORTH

The Duckworth family is of English ancestry, descending from Admiral Duckworth, of the English navy, and Canon Duckworth, whose monumental flag may be seen in Westminster Abbey.

(I) The Duckworths, on coming to America, settled in New Jersey, where John Duckworth, grandfather of John S. Duckworth, of Scranton, was a Revolutionary soldier, and bore a full share in the gaining of independence. John Duckworth was a sculptor of more than local fame, but later engaged in monumental decorative plaster work in Paterson, his native city. In 1856 he moved to Toronto, Canada, where he remained, engaged in contracting until his death in 1881, his wife also dying in that city. She was Maria M., daughter of Thomas Nightingale, of New York City, also of English descent. The Nightingale home later was for many years in Brooklyn. John and Maria M. Duckworth were the parents of fourteen children, John A. being the fifth.

(II) John A. Duckworth, son of John Duckworth, was born in Toronto, Canada, in 1869, died November 9, 1912. He was a graduate of Upper Canada College, class of 1877, then took a special course in architecture at Mechanics Institute, completing his studies with credit and graduating therefrom. For more perfect instruction in his profession he enrolled as a student under the celebrated Scotch architect, William Trouig, remaining under his capable teaching for five years, designing the Parliament Buildings in Toronto and many other important buildings. He gained fame in his profession and in 1880 moved to New York City, where he was associated with D. and J. Jardine, a noted firm of architects in that city. Later Mr. Duckworth was professionally engaged for short periods in San Francisco, Chicago and Buffalo, then spent another year in New York City. In 1882 he located in Wilkes-Barre, Pennsylvania, and became a member of the firm of Neier & Duckworth, but in 1883 came to Scranton. After a year spent in the employ of others he opened an office and began his long career in Scranton, attaining eminence in his profession and prominence as a citizen. His work was not confined to Scranton, but in every part of the Lackawanna Valley specimens of his ability as an architect and builder are found. He designed the Coal Exchange Building, at the time of its erection the largest building in the city; the Wells Building in Wilkes-Barre; the Hotel Jermyn in Scranton; public school buildings Nos. 7, 13, and 25, Scranton; the high school building and schools Nos. 1, 2, and 3, at Dunmore; the Home for Poor and Insane, at Ransom; St. Mary's Church, of Mt. Carmel; St. Rose Church, Carbondale; St. Thomas Aquinas Church, Archbald; Carbondale Public Hospital; the W. W. Watts Bank and "Leader" buildings at Carbondale; and over six hundred other prominent buildings and residences erected in Scranton and vicinity at a cost of over ten million dollars. His offices in the Coal Exchange were veritable "hives of industry," and from

them went out the plans and specifications that resulted in the beautifying of the city and in the employment of thousands of workmen in their execution. He was a recognized leader in his profession and in every way was a man worthy of the high position he occupied. He was a member of professional and scientific societies, was an Odd Fellow, and Elk, a member of the Scranton Rowing Club, a Republican in politics, and in religious faith a Presbyterian. He married Elizabeth De Vede, daughter of A. D. Spencer, and granddaughter of Edward Speneer, of the early Spencer family of Pennsylvania. His city residence is No. 607 Webster avenue, Scranton. Children: John S., Harry A., Emily M.

(III) John S. Duckworth, son of John A. Duckworth, was born in Scranton, 1889, and after passing through the public schools of that city, including the entire high school course, entered Cornell University, whence he was graduated, class of 1912, having specialized in the study of architecture and obtained his degree, B. Arch. After graduation he went abroad, visiting the noted countries, and studying the architecture of Greece, Italy, Switzerland, France, England and Scotland. This extended, interesting and valuable journey was taken with seven companions, forming a party under the personal direction of Professor Phelps, of Cornell University. From the study of the famous masterpieces of the genius of the Old World Mr. Duckworth returned to the United States and spent one year with Welch, Steurtevant & Pogge, architects of Wilkes-Barre, then returned to Scranton, where he was associated in business with his honored father until the death of the latter in 1912. He then succeeded to full control and conducts the large and prosperous business along the same lines of loyalty and efficiency upon which it was originally founded. During the past year he has planned many new buildings, including banks at Archbald and Dunmore, three schools for the borough of Old Forge, alterations to the Coal Exchange, and Parochial Hall, at Archbald, comfort station, city of Scranton. He is a member of L'Agrie Architectural Society, the Country and Canoe clubs, of Scranton, and of the Board of Trade. He is a Republican in politics, and a member of the Presbyterian church.

---

#### J. MOULTON WALKER

Sabinus Walker, grandfather of J. Moulton Walker, of Scranton, was a farmer of South Gibson, Pennsylvania, where his son, George A. Walker, was born February 21, 1828. The early life of George A. Walker was the usual one of a farmer's boy until he was sixteen years of age when he left the farm and apprenticed himself to the blacksmith's trade in Honesdale. After completing his apprenticeship years he became a journeyman smith, settling in Warren, Pennsylvania, where he became foreman for the Struthers-Wells Company. He embarked in mercantile life in 1870 by establishing a retail hardware store at St. Marys, Pennsylvania, removing four years later to Emporium, Pennsylvania, where he continued in business until his death. He became prominent in the business world and at the time of his death, November 3, 1905, was president of the First National Bank of Emporium and of the Emporium Water Company. He married, in January, 1853, Amanda Inglesby, who died in January, 1904; children: Stella L., married William L. Sykes; William S., Gertrude A., Grace A., George A. Jr., J. Moulton, of whom further.

J. Moulton Walker was born at St. Marys, Elk county, Pennsylvania, October 17, 1870. He prepared for college in the public schools of Emporium, later entering Pennsylvania State College, whence he was graduated class of 1890. He pursued the study of law under able preceptorship until May, 1893, when he was admitted to the Cameron county bar. He practiced in Emporium



for two years, coming to Scranton in June, 1895, where he has a well established practice in the state and federal courts of the district. Mr. Walker is senior member of the law firm of Walker & Capwell, Nos. 808-811 Peoples Bank Building, his residence No. 1715 Penn avenue. He is a member of the State and Comnty Bar associations, the Masonic Order, the Presbyterian church, and in political faith he is a Republican.

Mr. Walker married, October 18, 1892, Elizabeth C., daughter of Robert W. and Ella Hanna, of Lock Haven, Pennsylvania. Children: Helen Louise, born July 8, 1894; James Edward, March 25, 1898; Robert Hanna, July 27, 1901.

---

#### JOHN J. BRENNAN, M. D.

Three quarters of a century covers the American life of this family, founded in the United States by the immigration of John Brennan, of Ireland, grandfather of Dr. John J. Brennan, of Scranton, and his family, which consisted of one son and one daughter. Leaving his two children with relatives in New York, John Brennan joined the rush for the California gold fields in 1849, after which time nothing is known concerning his fate or whereabouts. The two children who accompanied him to the United States in 1845 were Edward C., of whom further, and Nellie, married a Mr. Nash.

(II) Edward C. Brennan, son of John Brennan, was born in Ireland, and when a child was brought to the United States by his father. He was reared in the home of relatives, and after attending school for a time became employed at mine labor, meeting an accidental death while so engaged in 1890. He married, in 1868, Margaret Purcell, member of a family founded in the United States by three brothers, who landed in Boston, Massachusetts, two of them, neither of whom married, moved to New Orleans and became wholesale merchants, the other settled in Pennsylvania and became the progenitor of the branch of the family of which Margaret (Purcell) Brennan, now a resident of Providence, Pennsylvania, is a member. Children of Edward C. and Margaret (Purcell) Brennan: Jennie, married Cornelius O'Donnell, of Wilkes-Barre, Pennsylvania, and has Helen and Stella; Mary, married a Mr. Grines, of Wilkes-Barre, Pennsylvania, and has a son, Gerald; Nellie, married John Maher, of Plymouth, Pennsylvania, and is the mother of Bernardine, Alberta, Eleanor; John J., of whom further; Joseph, deceased; Edward, a druggist, of Providence, Pennsylvania; James, deceased; Margaret, a trained nurse; Lillian; Joseph, deceased.

(III) Dr. John J. Brennan, son of Edward C. and Margaret (Purcell) Brennan, was born in Heckscherville, Pennsylvania, September 14, 1874. After attending the public schools of Plymouth he completed his general studies in the Wyoming Seminary and St. Thomas' College. Making his decision for the medical profession he entered the Medico-Chirurgical College, of Philadelphia, whence he was graduated M. D. in 1898. He was for a short time a practitioner of Shamokin, Pennsylvania, on June 6, 1899, establishing in the practice of his profession in Scranton, where he continues to the present time. His patronage has maintained a steady rate of increase until its present proportions cause him close confinement and steady application to his professional tasks, and he has become well-known as a physician, capable, reliable and upright, his standing in the ranks of those associated with him in medical pursuits being full assurance of his professional worth. The demands of his professional duties have left Dr. Brennan little time for participation in activities along other lines, and practically none for business relations, although he is a director of the Keystone Bank. Dr. Brennan affiliates with no political party,

his action along this line being governed entirely by circumstances and issues, his choice of candidates predicated solely upon their records and their ability for service. He is identified with the County and State Medical societies and the American Medical Association, and belongs to the Modern Woodmen of the World, the Knights of St. George, and the Knights of Columbus. His church is St. Patrick's Roman Catholic.

Dr. Brennan married Loretta, daughter of Patrick F. and Henrietta (Musky) Cannon, and has children: John, born September 27, 1904; Robert, born June 6, 1912.

---

#### ANDREW H. DOWNING

Andrew H. Downing, president of the Scranton Engraving and Electrotyping Company, operating at Nos. 1138-1144 Capouse avenue, founded in this city a business with which he had become familiar in Philadelphia, and which he had followed with profit in that place. He is of Irish descent, Ireland having been the birth-place of his father, Thomas Downing, in 1845.

Thomas Downing left Londonderry, his home, when he was but three years of age and accompanied an uncle, a shoemaker by trade, to the United States. When war between the states broke out he enlisted in Company A, Twelfth Regiment Pennsylvania Reserves, his regiment being attached during the early part of the war to the Army of the Potomac. He participated in all the battles and movements engaging his regiment, fighting in the Wilderness campaign and the battle of Gettysburg. The rigors of warfare seriously undermined his health, although he remained with his company, and he never entirely recovered from illness contracted during that period, his death resulting from that cause in 1869. He married Mary T., daughter of James and Elizabeth (Rusk) Gibson, her mother a grand-niece of Lydia Darrah, of historical fame. James Gibson was born in Savannah, Georgia, died in 1864. He fought under Commodore Decatur in the war with the pirates of Tripoli and was at one time a sailor on the "Alligator," an American privateer. James and Elizabeth (Rusk) Gibson were the parents of: George, killed in the battle of the Wilderness; Samuel; William; Walter; Mary T., of previous mention, married Thomas Downing; Anna; Kate, married Charles Hankins, who fought in Company A, Twelfth Regiment Pennsylvania Reserves. Thomas and Mary T. (Gibson) Downing had children: Andrew H., of whom further; Elizabeth, married a Mr. Thompson, of Scranton, and is the mother of Edna, Marie, Lillian.

Andrew H. Downing, son of Thomas and Mary T. (Gibson) Downing, was born in Philadelphia, Pennsylvania, May 17, 1866. For eight years he was a student in the public schools of his native city, later becoming associated with an electrotyping concern. Having learned the business he followed it for three years in Philadelphia and then came to Scranton, forming a partnership with Edwin G. Walford and establishing the Scranton Engraving and Electrotyping Company, a connection and a firm that endures to the present time, the relation having been filled with mutual satisfaction, congenial dealings and profit. Mr. Downing holds the thirty-second degree in the Masonic Order, also belonging to Irem Temple, Nobles of the Mystic Shrine, and holds membership in the Sons of Veterans, United Sportsmen's Association of Pennsylvania, and the Electrotypers' Union. Politically he is a Progressive Republican, and he holds membership in the Methodist Episcopal church.

## IRWIN W. SEVERSON, M. D.

Of the three generations of the Severson family with whom this chronicle is concerned, two have been members of the ministry of the Methodist Episcopal church, the third a medical practitioner. The family is of Holland descent, tracing a direct ancestry to William the Silent, prince of Nassau, New York state being the first American home of the family, which was afterwards founded in Pennsylvania. Rev. George Severson, grandfather of Irwin W. Severson, was a minister of the Methodist Episcopal church, and during his active life held pastorates in numerous places in Pennsylvania, including Waverly and Dunmore. He married Helen Hogan, and had children: Oscar L., of whom further; Wesley, married, and is the father of Howard and William; Nelson, died in 1914; Selina, married a Mr. Bleaksley, and lives in Binghamton, New York, the mother of Frank, George, Harry, Minnie, and Ida; Ursula, lives in Binghamton, New York.

(II) Rev. Oscar L. Severson, son of George and Helen (Hogan) Severson, was born in Binghamton, New York, and followed his father into the ministry of the Methodist Episcopal church. The majority of his charges were in New York state, where he is affectionately remembered as a minister of sincere devotion and good works and a preacher of earnest eloquence. Despite his ministerial position he found little difficulty in reconciling his principles with his sense of patriotic duty, feeling that the liberation of a people from bondage would justify man killing man, and early in the conflict between the north and the south he enlisted in the Union army. He was a soldier in Company E, One Hundred and Thirty-seventh Regiment New York Volunteer Infantry, and participated in many of the most memorable battles of the war, including Gettysburg, Fredericksburg, and Lookout Mountain, at which last place he was wounded. Rev. Oscar L. Severson married Ella Sanders, his wife a prominent member of the Daughters of the American Revolution, being entitled to membership therein through four ancestral lines. Children of Oscar L. and Ella (Sanders) Severson: Mabel, married a Mr. Page, a bank examiner, and resides in Erie, Pennsylvania, the mother of Ellen, Dorothy, and Eunice; Malvern, a graduate, C. E., of Cornell University, class of 1899, married Margaret Saunders, of Belfast, New York, and is the father of Malvern, Paul, and Philip; Irwin W., of whom further.

(III) Dr. Irwin W. Severson, son of Rev. Oscar L. and Ella (Sanders) Severson, was born in Smyrna, New York, May 10, 1880, there attending the public schools, later entering Wyoming Seminary, whence he was graduated in the class of 1900. For one year he was a student in Wesleyan Seminary, then beginning the study of medicine, he became a student in the medical department of the University of Columbia. From this institution he received his M. D. in 1906, in June of that year being admitted to practice in the state of Pennsylvania; on September 28, 1906, being granted his practitioner's rights in New York state. Dr. Severson has been identified with the professional life of Scranton since January 1, 1907, and at the present time is both well established in practice and the estimation of his professional brethren. He is a member of the medical staff of the West Side Hospital and belongs to the County, State, and National Medical associations. His church is that with which the name Severson has been so long and so honorably connected, the Methodist Episcopal, and in political faith he is a Progressive Republican. His club is the Craftsman, of Hyde Park, and he belongs to Hyde Park Lodge, No. 339, F. and A. M.

Dr. Severson married Sophia Jane, daughter of Frank H. Kyte, of West Pittston, Pennsylvania, and is the father of Wendell and Dorothy.

## JOHN L. JENKINS

Mr. Jenkins is a native of Glamorgan county, Wales, that locality the home of many previous generations of his family, where it is identified with the families of Davis, Evans, Lewis, many of whose members have achieved honorable reputation in America, where they were founded at an early date. John L. Jenkins is a grandson of Thomas Jenkins, who married Sarah Davis, and had children: David, of whom further; Edward, deceased; Thomas, deceased; Richard, deceased; Jenkins, deceased; Sarah, deceased. All of the sons of Thomas Jenkins followed agriculture as their life-long occupation.

(II) David Jenkins, son of Thomas and Sarah (Davis) Jenkins, was born in Glamorgan county, Wales, died there about 1888. His calling was that which claimed all of his brothers, farming, and in this line he met with favorable results. He married Jane, daughter of Thomas and Mary (Davis) Lewis, Mary a sister of Sarah Davis, who married Thomas Jenkins. Children of David and Jane (Lewis) Jenkins: Thomas, married Jane Miller; John L., of whom further; Sarah, married Thomas Evans, and has four daughters and two sons, all residents of Wales; William, married Lydia Williams, and has David, Jane, John.

(III) John L. Jenkins, son of David and Jane (Lewis) Jenkins, was born in Glamorgan county, Wales, December 15, 1840, and was there educated in the public schools. When he was seventeen years of age he established in drug dealings in his native land, so continuing until his immigration to the United States in 1879. In April, 1882, he moved to Scranton, and became associated with B. G. Morgan & Company, at the corner of Jackson and Main avenues, the present site of the West Side Bank, thus beginning an arrangement that existed for sixteen years with mutual profit and satisfaction. At the expiration of his time Mr. Jenkins started independent drug dealings, his former business, at No. 1528 Jackson street, where he has since been proprietor of a drug store. He has been successful in business, and is known as one of the most exacting and scrupulous of druggists, observing the letter of the regulations governing his business and in all things acting with honor and integrity. Mr. Jenkins has been a member of the First Welsh Baptist Church since his arrival in Scranton thirty-two years ago, while for thirty-one years of that time he has served on the board of deacons. His political party is the Republican.

Mr. Jenkins married Ann, daughter of Thomas Williams, of Tredegar, county of Monmouth, England, the ceremony being solemnized, October 4, 1864. Their children: Jane, unmarried; Margaret A., unmarried; Thomas W., married Mary Jane Davis, daughter of Evan J. Davis, of South Main avenue, Scranton; David J., married Anna, daughter of Rev. Edmund Probert, a minister of the Congregational church at Olyphant, Pennsylvania, and is the father of John Probert, David Gwynn, Edmund Lewis, Mary Evelyn.

---

 JOHN D. JONES

As assistant to the head of the International Correspondence Schools, of Scranton, John D. Jones occupies a position in the affairs of that organization well suited to his talents and abilities. His worth having been proven as a field representative of the school, his present high place is the evidence of worth realized and merit rewarded.

In 1897 he began his connection with the International Correspondence Schools, as manager of the field force, a position that necessitated travel in all parts of the United States and Canada. At the present time he is in the



*J. B. Jones*



Scranton office as assistant to Thomas J. Foster, president of the company, and discharges his manifold duties in a manner that in itself explains his rise to his responsible position. Many of the managerial details of the vast system of the schools are left in his care, and in no case has the confidence of Mr. Foster been misplaced. Mr. Jones is prominent in two fraternities, the Benevolent and Protective Order of Elks, in which he is past exalted ruler of the Scranton Lodge, and past grand esteemed lecturing knight of the Grand Lodge of the United States; and the Masonic, in which he holds the thirty-second degree, belonging to Otseningo Lodge, Free and Accepted Masons; Binghamton Chapter, Royal Arch Masons; Malta Commandery, Knights Templar, Otseningo Consistory, Sovereign Princes of the Royal Secret; Kalurah Temple, Nobles of the Mystic Shrine, all of Binghamton, New York. He is a member of the Board of Trade, Scranton Country Club, the Scranton Club and the Engineers' Society of Northeastern Pennsylvania.

Mr. Jones married, February 6, 1899, Erma, daughter of Angus and Christie (Smith) Bethune, both of Worcester, Massachusetts. Children: Kenneth B. and Erma H. Both Mr. Jones and his wife are communicants of St Luke's Episcopal Church.

---

#### MILTON ROBLEE

Into his less than half century of life Milton Roblee, the well known and popular manager of the Casey Hotel, has crowded an amount of action, experience, fortune and misfortune that woven together by the skilled pen of the novelist would make a drama of real life equal to any of those of the stage in which Mr. Roblee has portrayed other characters than his own. His path has led him into what the majority of people consider the enchanted region beyond the foot lights, and his name is not unknown to histrionic fame. But to connect the incidents of his life chronologically.

Milton Roblee was born at Saratoga Springs, New York, June 1, 1864. Until he was fourteen years of age he attended the public schools, completing his preliminary studies and entering Warrensburg Academy where he took the four year preparatory course for Cornell University. Although he had always anticipated with pleasure a college career, instead of entering college he accepted a position as clerk in the Woodruff House at Watertown, New York, this being his first connection in the business to which he afterward devoted so much of his time and talents. While at this place he became actively interested in amateur theatricals, and displayed abilities of such high order that upon attaining his twenty-first year he was offered an engagement in professional ranks. From 1885 until 1892 he successfully executed leading roles in many of the favorite plays of the day, including "Siberia," "The White Slave," "Lights o'London," "Silver King," "James O'Neill," "Mme. Jamescheck," and was featured as Phileas Fogg in the gigantic production of "Around the World in Eighty Days." Between seasons he made profitable use of his knowledge of the hotel business by accepting positions as steward, clerk and manager of hotels at summer resorts. In 1892 he retired from the stage to accept a position as clerk in the Hotel Bartholdi, at that time one of the most exclusive of the large New York hotels, and when the Hotel Imperial was opened joined the office force of that house. He resigned his latter place to become manager of the Barrett House, later named the Cadillac, now known to the public as Wallick's. His next business venture was in Jersey City, where he leased Taylor's Hotel, and after conducting that hotel for two years he leased and managed the Hotel Bartholdi, Broadway and Twenty-third street, where he achieved the greatest success of his career up to that point. He enlarged his field and the Hotel

Belleclair, Broadway and Seventy-seventh street, a magnificent three hundred room hotel, erected at a cost of more than a million dollars, was built at his direction. For four years he fought a losing fight against what appeared to be doomed failure, and at the end of that time was obliged to retire from business with a loss of nearly half a million dollars, having fought desperately to avert this issue and to make his establishment a paying investment. When Casey Brothers of Scranton planned and erected the stately and imposing Hotel Casey, a matter that gave them no little concern was the selection of a man to place in charge of their costly and valuable establishment. From a thousand applicants for the position, the past records of all of whom were searched with minute care to determine their responsibility, Mr. Roblee was chosen. More than once have the owners of the establishment found cause to congratulate themselves upon the excellence of their judgment; more than once have the patrons of the Hotel Casey felt themselves fortunate in having their comfort and convenience guarded by so solicitous a host; and more than once has Mr. Roblee found pleasure in the favor his efforts have received, in the increasingly wide reputation of his hotel and the commanding position it holds among houses of a like nature in Scranton.

In Scranton, as in New York, Mr. Roblee has become prominent socially and fraternally, although in the former city he was more closely identified with political situations. In later years, too, he has withdrawn entirely from theatrical connections, but while manager of the Hotel Bartholdi leased and managed several productions, among them "A Temperance Town," "The Midnight Bell," "Haverly's Mastodon Minstrels," and "Two Nights in Rome." While in this city he was general director of what was probably, from a financial point of view, the most successful fair ever given, The Actor' Fund Fair, given at the Metropolitan Opera House the week of May 4, 1907, more than one hundred thousand dollars being realized for the fund in one week. Mr. Roblee is a gentleman of dignity and courtesy, agreeable and affable to every one at all times. He is a virtuoso in gems and paintings and has a lapidary's knowledge of the value and desirability of diamonds, and has advised many of his friends in the purchase of such stones, besides owning many fine specimens. He is familiar with all the master pieces of the world's greatest artists of all schools and finds in them a source of much enjoyment. These are the diversions with which he relieves the tedium of business, for even with the varied experiences one meets in his line such occupation is found restful and refreshing, besides its cultural benefits and the place it affords among art connoisseurs.

Mr. Roblee married, October 25, 1909, Margaret A. Gould, of Poultney, Vermont.

---

#### GEORGE W. WATKINS

Born in England and there educated, Mr. Watkins has so thoroughly fallen into accord with his surroundings and so ably availed himself of his opportunities in his adopted country that he stands at the head of his especial business, interior decoration of all kinds. The originality and beauty of his designs and the high quality of all his furniture and decorations have not alone won the regard and patronage of Scranton's best people, but in thirty-eight states of the Union are his customers found. This recognition of merit, while pleasing to the recipient, is not undeserved, but has been won by thorough preparation, close attention to detail, and constant search for new designs, better materials, and more skillful workmen. To this end he has traversed Mexico, Canada, and the United States in search of ideas; four times has he toured



Europe for designs and study of the furniture and decoration of the different periods. His American automobile that he took with him on his last trip carried him everywhere that he wished to go and greatly added to the pleasure and success of his journeying. As head of his own business, Mr. Watkins can review his career with satisfaction, trace his course from clerk steadily upward, and know that success has been honorably won. Mr. Watkins traces his descent from a long line of English ancestors, his grandfather, a mine-owner, having inherited ancestral lands. He is a son of Celia Watkins and Elizabeth Whislance, who were married in England. When his son, George W., was four years of age, Celia Watkins, the father was accidentally killed. His widow yet survives him, a resident of England.

George W. Watkins was born in Abergavenny, England, January 6, 1864, and obtained his education in the public schools. He began business life as clerk in the office of his uncle, who was superintendent of an important steel plant. He remained in that position for two years, then suddenly decided to come to the United States in company with a young man who was an engineer in the same plant. His decision was made Thursday, and on Saturday he left his native land, arriving in due time in New York City. This was in the year 1885, and after a short time spent in Pittston, Pennsylvania, he located in Scranton. He here obtained employment with S. G. Kerr, at 406 Lackawanna avenue, carpet and drapery store. While this business was entirely new to him, Mr. Watkins, beginning at the bottom, mastered its every detail. In an emergency his knowledge of machinery, gained in the steel plant in England, was of service to his firm, and for a short time was in charge of the carpet cleaning and manufacturing plant. He later was a member of the firm S. G. Kerr & Company, and of the succeeding firm, Kerr, Siebecker & Company, he representing the company in Kerr, Siebecker & Company. He developed an unusual selling ability, and gained the reputation of being "the best salesman in the Lackawanna Valley" among those who were qualified to judge. In 1894 Mr. Kerr retired from the firm, which continued as Siebecker & Watkins. In 1899 Mr. Watkins became sole owner and has so continued. His business is manufacturing and retailing interior decorations of all kinds, including fine furniture and hangings. He has attracted the attention of people of means and appreciation, resulting in calls for his services in decorating and furnishing many fine homes. An instance may be quoted that will illustrate the extent of his operations. During the summer of 1913 he employed fourteen men in the city of Brooklyn alone. His entire force in all departments numbers 125. The specially designed furniture. While his designs are all original and the work-fabrics used in his hangings are imported, as is much of the wood used in his mansion the best, the mainspring of his success is quality and a high sense of business honor. To him profit is not a matter that outweighs all else, but is secondary to a faithful execution of all his contracts. His business has steadily grown until he is head of the largest interior decorative business in this section, and one not surpassed in volume by any retail house outside of the large cities. He moved to his present location at the corner of Jefferson avenue and Spruce street in 1910, and there has attracted the liberal patronage of people of wealth and taste in thirty-eight states.

Mr. Watkins is a member of the Scranton Board of Trade, the Commercial Association, the Scranton and Temple clubs, and the Navy League, the latter a body of patriotic citizens interested in the American navy, meeting annually in March, when they entertain and are entertained by the highest government officials and representatives. He belongs to all Masonic bodies in both York and Scottish rites, holding in the latter the thirty-second degree. These bodies are: Peter Williamson Lodge, Free and Accepted Masons; Lackawanna Chap-

ter, Royal Arch Masons; Scranton Council, Royal and Select Masters; Melita Commandery, Knights Templar; Keystone Lodge of Perfection; Keystone Council, Princes of Jerusalem; Keystone Chapter, of Rose Croix; Keystone Consistory, Sovereign Princes of the Royal Secret, all of Scranton; and Irem Temple, Ancient Arabic Order Nobles of the Mystic Shrine, of Wilkes-Barre.

Mr. Watkins married, in 1885, Hannah E. Evans, of Merthga. Children: Marian, married Harry D. Justin; Emily, married Charles Watres; Florence, single and at home with her parents. The family residence is No. 235 Jefferson avenue.

---

### JAMES A. HANNON

As yet a tyro in the business world, Mr. Hannon, by his ability and special courses of preparatory study, has gained a position that promises well for his future. Born and educated in Scranton he has availed himself of the best of her school advantages and so far as possible has fitted himself for positions of honor and trust. To this, years of experience must be added, but as the law of supply and demand will govern in the future as in the past, and the doctrine of the "survival of the fittest" will always prevail, there is no doubt that the biographer of the future will find a great deal more to record of the business rise of Mr. Hannon than is possible at this early stage of his career.

He is the son of James J. Hannon, born in county Mayo, Ireland, coming to the United States a lad of seventeen years. He located in Scranton where he was an iron mill worker in employ of Connolly & Wallace. He married Ellen Cawley, who bore him: Joseph T., a resident of Scranton; Mary, married M. F. Reardon, of Scranton; Helen; Elizabeth; Theresa; Ann; Agnes; Loretta; James A. and William.

James A. Hannon, was born in Scranton, September 12, 1891. He attended the public schools and Saint Cecelia Academy and after a three years' course at the latter, entered Scranton Central High School, whence he was graduated class of 1909. He began business life with the Delaware, Lackawanna & Western Railroad Company, later becoming bookkeeper with the Merchants and Mechanics Bank of Scranton, a position he now fills. To his years of general study, Mr. Hannon has added the courses prescribed by the Wharton School of Finance, an extension of the University of Pennsylvania. He is also a member of the Scranton Chapter, American Institution of Banking, supplementing his practical work in the bank by means of instruction and method gained by connection with these valuable institutions. He is a member of Saint John's Total Abstinence Society and interested in the healthy athletic sports and diversions of the clean minded, enthusiastic American young man.

---

### JOHN G. HUGHES

Born and educated in Scranton, Mr. Hughes here began his business life and has ever been connected with the house of which he is now an honored member, The Pierce Company. His father, Evan D. Hughes, was born in Butler, Pennsylvania, in 1837, later becoming a merchant of Scranton. He served in the Civil War in the Sixth Regiment Pennsylvania Cavalry, attached to the Army of the Potomac. At the battle of Beverly Ford he was wounded and fell into the hands of the enemy, but before the day ended was recaptured by the Federal troops. After the war ended he returned to Scranton and became a conductor on the Lackawanna and Bloomsburg Railroad, a position he held until his death in 1908. He was a prominent member of the Masonic order, was a past eminent commander of Crusader Commandery, Knights

Templar, and held the thirty-second degree Ancient Accepted Scottish Rite. He married Anna M., daughter of John Grover, of Hicks Ferry, Pennsylvania. Children: Thomas R., Carl S., John G., Ida B., Emory, Elizabeth, married Dr. Charles Hoose, of Albany, New York.

John G. Hughes was born in Scranton, Pennsylvania, March 9, 1870. He was educated in the public schools and at Wyoming Seminary, beginning business life in 1888 with the firm of Pierce & Holgate. He continued with that firm until 1894, when The Pierce Company was incorporated as its successor, Mr. Hughes becoming a member of the corporation. Until 1911 he was vice-president and manager of the wholesale department, in the latter year becoming president and general manager of both stores operated by The Pierce Company. He is a member of Green Ridge Lodge, No. 597, F. and A. M.; Lackawanna Chapter, Royal Arch Masons, Melita Commandery, Knights Templar, Irem Temple, Nobles of the Mystic Shrine, the Heptasophs, the Modern Woodmen, and the Fraternal Mystic Circle. In politics Mr. Hughes is an independent Republican, holding principles and men above party allegiance. He married, May 23, 1894, Bertha C., daughter of Dr. A. B. Longshore, of Scranton, Pennsylvania.

---

#### ALFRED MILTON BAKER JR.

Although the search of Alfred Milton Baker for a vocation carried him to far away New Mexico, where he was not content to remain, it appears that as the agent and distributor of the Hupp Motor Car Company, manufacturers of the Hupmobile, in northeastern Pennsylvania, he has found a field of endeavor both to his liking and for which he is peculiarly well fitted.

Mr. Baker's birthplace is Michigan, but in spite of this fact he is justly claimed as a Pennsylvania product, inasmuch as that state was the birthplace of the two generations of his family preceding him, Vermont being the birthplace of his great-grandfather. His grandfather, John Baker, was in his early life a resident of Clifford, Pennsylvania, but in later years moved to Scranton, engaging in the livery business and for several years running a stage from Factoryville to Tunkhannock, long before the days of electric roads. He married Nancy Callander, a member of the family whose part in the struggle for independence was so conspicuous and glorious. His children were: Alfred Milton, of whom further; Herbert L., an attorney of Detroit; Julietta; Adelaide; Boyman; Emma. The two latter are deceased.

Alfred Milton Baker was born in Susquehanna county, Pennsylvania, July 20, 1835. For several years he was engaged in business in partnership with W. S. Courtright, and after the dissolution of that connection became a commercial traveler in the employ of a Detroit shoe manufactory. He then purchased a farm in Michigan and resided thereon for fifteen years, coming to Pennsylvania in 1884, where he resided up to his death, March 15, 1914, at seventy-nine years. He married Josephine, daughter of John Milton Witherbee. Children of Alfred Milton and Josephine Baker: John E., secretary of the Hupp Motor Car Company, of Detroit; Helen J.; Alfred Milton, of whom further.

Alfred Milton Baker Jr. was born at Clarkstown, Michigan, October 26, 1879. In his early youth his parents moved to Scranton, and in the public schools and Central high school of that city he received the major part of his education, completing his studies at the Keystone Academy. His first business experience was in the employ of the Alomogordo Lumber Company, in New Mexico. After a year's service with this company he entered the employ of the International Correspondence Schools, of Scranton, and in 1908 entered the employ of the Hupp Motor Car Company. As the history of Mr. Baker's

connection with this company is, to a great extent, the story of that company's extension and development, a short outline of the company's existence will be given. In the spring of 1908, with the modest capital of twenty-five thousand dollars, a company was formed in Detroit to build a motor car of graceful and pleasing design, built on the same principles of construction and with as finished workmanship as found in the highest priced cars on the market. By November of that year the first experimental car was in operation and a factory had been rented to produce the first output of five hundred cars. As the car found favor with the public, both in appearance and endurance, the factory was deluged with orders far beyond its small capacity and a large factory with every modern equipment of machinery for the special requirements of the Hupmobile was built on Jefferson and Concord avenues. In the beginning of the 1910 season the company was prepared to meet a demand for five thousand cars, but during the next two seasons even that provision proved entirely inadequate, and the company was compelled to conduct many of its operations in shops and factories separate from the main plant and scattered throughout the city. In November, 1911, plans were drawn up and ground broken for a five acre plant. One of the most interesting points about the erection of the factory was the manner in which the handicap of severe cold was overcome. At one time, with the temperature below zero, the contractors raised a large circus tent, two hundred feet in length, over the site of the administration building, then under way, and under this protecting canvas a boiler and salamanders were installed. By this method the bricklayers and ironworkers were able to resume operations at the comfortable temperature of sixty-five degrees, although bitter cold prevailed without. The buildings were finally completed in March, 1912. The plant comprising three main industrial buildings, two stories in height, covering factory floor space of several hundred thousand square feet, is erected in parallel, with road trackage and avenues between each pair of structures. These buildings are connected on the upper floors by means of communicating bridges, and are bounded on the rear by belt line tracks, along which is an immense shipping platform. An administration building, two stories in height, which includes a floor space of nearly thirty thousand square feet, extends completely across the front of the industrial buildings. Since March, 1912, two additional buildings, one for the final assembly, and the other a storage warehouse for parts, have been erected. To provide for the Canadian trade, a factory was begun, simultaneous with the erection of the Detroit plant, at Windsor, Ontario, with a capacity of three thousand cars per year, so constructed that additions may be made at any time to increase the capacity. Because so many of the parts can be manufactured from material obtainable in Canada, a substantial reduction in price can be made to Canadian purchasers.

In 1909 Mr. Baker was appointed distributing agent for northeastern Pennsylvania, and in the four years of his incumbency of that position has persistently and energetically labored to keep his car in the front rank of automobile trade, an endeavor in which he has been very successful. The agent for a car of quality, at a price not prohibitive, and with recorded tests proving its superiority in many departments, he is backed by an argument more powerful and convincing than words, a machine of beauty and grace of design, strength of construction, and moderateness of price. Mr. Baker is a Republican in political belief, belongs to the Automobile Association, and is a member of Waverly Lodge, No. 301, F. and A. M.

## JOHN T. CORLEY

County Mayo, Ireland, was the original home of the ancestors of John T. Corley, one of Scranton's most enterprising and active real estate dealers. It was in this part of Ireland that his grandfather, Michael Corley, and his father, Andrew Corley, were born. Andrew Corley followed the sea all his life and for many years was first officer on a transatlantic liner. He married Mary, daughter of Edward McCormick, a native of Ireland. Among his children was John T.

John T. Corley was born near Boston, Massachusetts, in 1863, where he made his home during the absence of his father on his many voyages. When he was seven years of age his family moved to Ireland and there he obtained an education in the public schools, attending the same until he was sixteen years of age. He then went to England, apprenticed himself to the landscape gardener's trade, and for five years was employed in that business at Yorkshire. He then determined to come to the United States, and engaged passage on the "Baltic," of the White Star Line. After an uneventful voyage of ten days, the vessel docked at Castle Garden, New York. Mr. Corley came at once to Pennsylvania, and obtained his first employment as a laborer in Avoca, three months later entering the mines. Three years of this labor left him with a decided distaste for any more of the same, and he moved to Scranton, engaging in landscape gardening, the trade he had learned in England. In connection with this work he began to conduct real estate operations, and on April 4, 1904, was appointed general manager of the Globe Real Estate Company, of Scranton. After a year's service with that corporation he decided to begin operations independently and resigned his position, confident in his own business ability and with faith in his future success, a confidence and faith that the passing years have proved to be founded upon the keenest introspective observation. In 1907, his real estate dealings having assumed dimensions that made it imperative that more time be given thereto, he withdrew from landscape work and has since concentrated all of his attention and time to the former business. Mr. Corley is a member of St. John's Church, and belongs to St. Paul's Pioneer Corps. His political stand is made according to the dictates of no party, his action in political matters depending entirely upon his judgment in regard to the situation.

Mr. Corley has in his business life shown resourcefulness and determination that has led to his ultimate success, a spirit that to those who credit heredity must have descended to him from his sailor father who, often, when in command of the vessel of which he was first mate, was forced to pit his brain and nautical knowledge against the power and strength of the elements, with a far greater prize at stake than his own fortune. Many times the fate of the entire ship was in his hands and with the courage of decision and quick resourcefulness that he developed he preserved the safety of his precious freight of human lives, and this trait has descended in full force to his son, so that, in overcoming the obstacles of business, he has made for himself a reputation as a clever, able, albeit fair and honorable, business man.

Mr. Corley married, in 1878, Sarah, daughter of John and Bessie (Finn) Murphy. Children: Margaret, John, Bessie, Andrew, Rhoda, Mary, deceased; Mary, Sarah.

---

WILLIAM CARL SCHOENFELD

Scranton has known two generations of Schoenfelds in connection with the undertaking business, and it is probable that the same name, identified with

that occupation, will continue for at least one more generation. The relation began with Reinhard Schoenfeld, born in Weisbaden, Nassau, Germany, January 13, 1835, son of George William Schoenfeld, who was a native of the same locality, a farmer by occupation, owning the fertile acres that he tilled, and in addition to agricultural operations was also a boot and shoemaker, his death occurring in 1849, when he was fifty-three years of age. He was the parent of six children who survived childhood. The form of the name as it is spelled at the present time is not that which was used in the homeland, but because of the difficulty experienced by foreigners and those unversed in the German tongue in acquiring a correct pronunciation of vowels marked with an umlaut, "oe" was substituted for "o" with this modifying designation.

Reinhard Schoenfeld's mother died when he was two years of age, and twelve years later he was left an orphan, being apprenticed to the wheelwright's trade when he was fifteen years of age. In 1853, the ties of home having been most effectually sundered by the death of his parents, he engaged passage in a sailing vessel leaving Antwerp and two months later landed in New York City. He at once proceeded to Honesdale, Pennsylvania, there being employed for a short time at the coal docks of the Delaware & Hudson Canal Company, for the next two years following the trade he had learned in Germany in a wagon shop. Coming to Scranton in 1855, he entered the car shops of the Delaware, Lackawanna & Western Railroad Company, and was there employed for about thirteen years, in 1868 establishing an independent business as the proprietor of a general provision store on Cedar avenue. Dissatisfied with the returns from this venture in proportion to the capital and labor expended, at the end of a year he retired therefrom and engaged in carpentering. In 1869 he embarked in the undertaking business, managing in connection therewith for several years a furniture store, his first location being on Penn avenue. He afterward moved to Lackawanna avenue, later returning to Penn avenue, and subsequently locating at No. 318 Franklin avenue, his present place of business. No branch of his business has been neglected and excellent service of high grade has won for the house a creditable reputation. Funeral directing is a line to which he has given particular attention, and through his office complete arrangements for such a ceremony can be made. Since 1910 Mr. Schoenfeld has lived retired from active participation in the business that he founded, his son, William C., managing its affairs.

Mr. Schoenfeld and his wife are members of the Zion Lutheran Church, regular attendants and active workers in its sub-organizations. Mrs. Schoenfeld having been for two years president of the Ladies' Society, for six years its treasurer, and four years secretary. Mr. Schoenfeld was formerly a member of the German Presbyterian Church, to which he lent his devoted support, being a member of the choir of that organization, a trustee of the same, and superintendent of the Sunday school. He is identified with no political party, and at one time affiliated with the Independent Order of Odd Fellows.

He married, in Scranton, Pennsylvania, in 1857, Barbara Schwartz, born near Stuttgart, Wurtemberg, Germany, daughter of Andrew and Barbara (Housman) Schwartz. Her father was a farmer in the homeland, and after her parents' death Barbara Schwartz, in 1854, immigrated to the United States, making her home in Washington, two years later moving to Scranton. Reinhard and Barbara Schoenfeld are the parents of William C., of whom further; Amelia, married a Mr. Wenzel, and died aged twenty-seven years; Mary, died aged twenty-six years.

William Carl Schoenfeld, son of Reinhard and Barbara (Schwartz) Schoenfeld, was born in Scranton, Pennsylvania, October 7, 1858. After obtaining his education in the public schools of the city he entered his father's





Jay Miller Fahringer.



business, which he learned under the painstaking instruction of the elder Schoenfeld. He was his father's competent assistant until Mr. Schoenfeld's retirement in 1910, since which year he has managed the business in a manner no less able than that under which it was brought to its present high plane of prosperity. William C. Schoenfeld is a member of the Lutheran church.

He married, September 15, 1891, Elizabeth Catherine Koch, born April 16, 1867, daughter of John Henry and Anna E. Koch. John Henry Koch was born in Rotenburg, Prussia, Germany, October 18, 1835, immigrating to the United States and settling in Hyde Park about 1855, where he followed his trade, that of carpenter. In 1860 he was employed in the car shops, three years later becoming proprietor of a hotel on Franklin avenue, which he conducted for about three years, for the following eighteen years being host of a hotel at Olyphant. After residing in Green Ridge for two years he moved to Scranton and for two years owned and managed a hotel at the corner of Penn avenue and Center street, at the end of which time he sold the property and obtained a mercantile agency for Simon Rice, building his present home on Capouse avenue. Children of William Carl and Elizabeth Catherine (Koch) Schoenfeld: 1. Reinhard Karl, born April 18, 1893; after leaving the city's high school in the third year, he began to take an active part in the undertaking profession, and in February, 1914, he graduated from the Renouard Training School for Embalmers of New York City, after which he successfully passed the state examinations at Philadelphia, and is now active in the profession. 2. Karl William. 3. Kenneth Koch, born January 7, 1900, a student in grammar school.

---

#### JAY MILLER FAHRINGER

There are many men in the mercantile and financial world of Scranton who will testify to the worth of Jay Miller Fahringer as a merchant, and those who know him outside of his business connections are unanimous in their praise of his daily deportment and sincere in their appreciation of the influence he has wielded in the city of his adoption, Scranton. His position among the foremost merchants of the city is one that he owes to a proper and legitimate exercise of the strong faculties with which he was endowed by bountiful Nature, not the least of which has been an unyielding determination to succeed, not only in material affairs, but to make his life a true success in service to his fellow men. In what measure this has been realized the following recital will show.

The ancestry of the Fahringers of Pennsylvania is Dutch, Holland having been the land whence came the immigrant of this line. The first of this record is Jonas Fahringer, by trade a blacksmith, who married a Miss Marks, and had children: Reuben; Jeremiah, of whom further; Hilda, married a Mr. Blass; Caroline, married a Mr. Bird; Mary, married a Mr. Murray, and resides in Danville, Pennsylvania. Jeremiah, son of Jonas Fahringer, was born in Pennsylvania, December 14, 1834, died in October, 1912. Learning the carpenter's trade, he advanced beyond journeyman's estate and became a builder, later for many years being employed as foreman in the Pancoast Coal Mines at Throop, Pennsylvania. He married Elizabeth, daughter of Mahlon Kase, and was the father of: Melissa, married S. R. Stanton, and lives in New Jersey; Jonas, employed as foreman in a manufactory at Port Henry, New York; Millie, married William H. Crookshanks; Charles, a hardware merchant, engaged in business at Ashland, Pennsylvania; Sanford, an engineer at Louisville, Kentucky; Jay Miller, of whom further; Bessie, deceased; Frank, a

bookkeeper, employed by a firm in Pottstown, Pennsylvania; Archibald, resides at Peckville, Pennsylvania; Lulu, deceased.

Jay Miller Fahringer, son of Jeremiah and Elizabeth (Kase) Fahringer, was born at Shenandoah, Pennsylvania, December 7, 1869. For four years of his youth he attended the public schools at West Pittston, at the expiration of that time entering the mines as slate picker. When he was fourteen years of age he became a clerk in the store of a coal company at Throop, and was similarly engaged in the stores of various companies until 1901. In this year he moved to Providence, Pennsylvania, opening a store under his own name at No. 2901 North Main avenue. The rental of this establishment and the purchase of his stock required the expenditure of all of his slender capital, and being prepared to stand or fall as a merchant, the decision resting upon the fate of this store, he threw himself, mind and body, into the task of making his first investment a profitable one. The store weathered the uncertainty and lack of confidence felt in a new institution, and soon became a thriving establishment, marking Mr. Fahringer's first conquest in the mercantile world. He was in Providence at this location for four years, later moving to No. 2456 North Main avenue, where his present store is now located. Mr. Fahringer is a member of Hiram Lodge, Free and Accepted Masons; Celestial Lodge, Independent Order of Odd Fellows; the Junior Order of United American Mechanics; and the Modern Woodmen of America. His church is the First Christian Church of Providence, and in this organization he holds the position of superintendent of the Sunday school. In connection with his duties as the head of the Sunday school he is the teacher of a Men's Bible Class whose membership numbers one hundred and twenty-five, one of the largest men's classes in the state. Mr. Fahringer, because of his admirable facility of expression, his ease in conversation, and his graceful manner of presiding over such a gathering, is particularly well fitted to hold such a place, and the meetings of this class are inspiring in the earnestness that governs all discussion and the spirit that animates its members. That Mr. Fahringer is popular with the members of his class is shown by its constant increase in membership and the regularity of attendance. An organization of such strength and so definitely connected with Christian work is a powerful feature in the moral and religious welfare of a city, and Providence is well in the lead in the movement for men in religion.

Jay Miller Fahringer married Maggie, daughter of William Birtley, of Belleville, Illinois. They are the parents of: William, married Bernice Oakley; Susie, Marjorie, Jay, Mahlon.

---

#### THOMAS HENRY MEAD

Born in New Jersey, Mr. Mead was brought to Pittston, Pennsylvania, when but an infant, his entire life from that time having been spent in the Lackawanna and Wyoming Valleys, where he has long been connected with important business firms and corporations. He is of English ancestry descending from Dr. William Mead, who on coming to the United States located in New York City, where William Mead, grandfather of Thomas Henry Mead, was born. William Mead became a New Jersey farmer, married and reared a family.

Thomas Henry Mead, son of William Mead, was born in Newark, New Jersey, and there was educated in the public schools. He is a veteran of the Civil War, serving from Bull Run through many other bloody battles fought by the Army of the Potomac. He was honorably discharged at the close of the war, after which he returned to Newark, where he was connected with

the Springfield Avenue Street Car Company. He later moved to Pittston and was there employed in a paper mill for a time, then becoming a partner with his brother-in-law, A. B. Rommel, and engaged in farming. He married Mary A., daughter of John Christian Frederick Rommel, a grandson of the great botanist, who was sent by the King of the Netherlands to this country on a scientific mission, but becoming so enraptured with the United States and its institutions that he refused to return to Holland, thereby forfeiting his inheritance. He died in Hampton, Virginia. Children of Thomas Henry and Mary A. (Rommel) Mead: 1. Thomas Henry, of whom further. 2. George B., born October 24, 1868; educated in the public schools; married Mary L. Evans, of Throop, Pennsylvania; is now engaged as shipper for the collieries of the Temple Iron Company, in Scranton, Pennsylvania; children, George B., Margaret, Lois Eva Lena; he is a member of the Methodist Episcopal church and the order of Heptasophis.

Thomas Henry (2) Mead, son of Thomas Henry (1) Mead, was born in Dover, New Jersey, January 23, 1863. During the same year his parents moved to Pittston, Pennsylvania, where he was educated in the public schools and resided during his entire minority. He began business life early, as a clerk in the grocery store owned by his uncle, Frank Rommel, later becoming a finisher in the paper mills of G. B. Rommel, going from there to the meat merchants, Ross & Company. In 1886 he began his connection with the coal business, starting as paymaster and superintendent of shipments for the Enterprise Coal Company, then conducted by Andrew Langdon, of Buffalo, New York. In 1890 the Enterprise mines were sold to the Lehigh Valley Railroad Company, Mr. Mead transferring his allegiance to the Babylon Coal Company, then conducted by Simpson and Watkins. He was first paymaster and shipper, then was promoted to the position of foreman. He continued with the Babylon Company until their plant was consumed by fire, then became payroll clerk for the Mount Lookout Coal Company, of Wyoming, continuing until 1901, when he was transferred to Scranton as voucher clerk for the Temple Iron Company, purchasers of the Simpson and Watkins properties. He was made bookkeeper in 1903 and continued as such until 1909, when he was promoted to his present position as auditor and paymaster of the company, a vacancy having been caused by the death of George L. Houser. In 1910 the Temple Iron Company was dissolved, the constituent companies returning to their original form. By these companies Mr. Mead was retained as auditor, now serving them individually instead of as the amalgamated Temple Iron Company. These are the: Northwest Coal Company, Edgeton Coal Company, Sterrick Creek Coal Company, Lackawanna Coal Company, Mount Lookout Coal Company, Babylon Coal Company, and the Forty Foot Coal Company. His record is one of honorable service and the fact that he was the choice of all the subsidiary companies is a high tribute to his efficiency. Mr. Mead is a deacon of the First Baptist Church of Scranton, a Master Mason of Hyde Park Lodge, No. 339, F. and A. M., a member of Roaring Brook Lodge, No. 401, K. of P., the Royal Arcanum, and of the Craftsmen Club. In political faith he is a Republican.

Mr. Mead married, June 10, 1885, Marie A. Lewis, of Swansea, Wales, one child, Marjorie B., born at Watkins Glen, New York, June 20, 1897. The family residence is at No. 825 West Elm street.

---

#### GEORGE WAHL

The Wahls were an old family of Germany, where Matthias Wahl, father of George Wahl, of Scranton, filled a government official position for half a

century, retiring with honor and receiving a substantial token of appreciation on the occasion of the celebration of his fifty years of honorable service. Matthias Wahl was born in Flornheim, Germany, in 1805, married Gertrude Kretschmar, and had twelve children, all now deceased, except George and Theresia Sandler, a sister.

George Wahl was born in Germany in 1848. He was educated in one of the noted gymnasiums of Germany, intending to fit himself for the profession of teaching. His elder brother, John, emigrated and came to the United States, and when on a visit to Germany had so glowing a story to tell of his American home that on his return to the United States he was accompanied by his younger brother, George. In December, 1864, they arrived in Scranton, where John Wahl was proprietor of a barber shop. The young man, in order to get a start and to meet expenses during the first months, when all was new and strange, decided to work for his brother, and making excellent progress he continued until he became proficient. In a few years he became proprietor of a barber shop and baths in the Lackawanna Valley House, then Scranton's leading hotel. In 1890 he entered into partnership with Frank Humler, they becoming owners of the Scranton Journal Printing Company, then issuing a small weekly newspaper in the German language. The partners enlarged the weekly from an eight page to a twenty-four page weekly, and greatly increased both the subscription list and the advertising accounts. Leaving the principal burden of the newspaper to Mr. Humler, Mr. Wahl entered the life insurance field, and he met with such success that in 1904 he retired entirely from the newspaper to devote himself exclusively to the insurance business. He is now district agent for that sterling institution, The Penn Mutual Life Insurance Company, of Philadelphia. Mr. Wahl is one of the pioneers in the insurance business in Scranton, and has fairly earned honorable standing among the business men of merit in the city. He is still actively engaged in the business, and though the immediate need of revenue has long since passed away, he finds the greatest enjoyment in the field and among his long-time associates. His genial personality has won him many warm friends, and as a citizen he has always been public-spirited and active. He has promoted to the full extent of his ability the interests of his adopted city, has served as a member of important committees of the Board of Trade, and is interested in several of Scranton's industries and in her financial institutions. During the half century of his residence in Scranton he has several times laid aside the cares of business to revisit his native land and the scenes of his youth. He was one of the organizers of the popular German singing society, the Scranton Liederkrantz, has always taken a deep interest in its welfare and is now the only surviving charter member of the body of young men who about forty-six years ago met and formed the society. He has never aspired to political honors, although they have been easily within his reach. He is a member of the Knights of Columbus, the Benevolent and Protective Order of Elks, Younger Maennerchor and several other societies.

Mr. Wahl married Katherine, daughter of Henry and Cornelia (Werthemmer) Dimler. Her mother, Cornelia (Werthemmer) Dimler, came from Germany with her father and sister about 1854, settling in Scranton, Pennsylvania. Their first home was a log cabin, situated near the present site of the Church of the Nativity. This carries back to pioneer days in Scranton. Mr. Wahl resides at No. 523 Taylor avenue, his offices being Nos. 307-08 Board of Trade Building.

## THOMAS FRANKLIN EYNON

The Eynons came to Pennsylvania from Wales, the emigrant, Thomas Eynon, son of John Eynon, settling in Carbondale in 1831. He is credited with having sunk the first coal mining shaft in the valley of the Lackawanna and was later interested in the manufacture of iron and steel. He came from Carbondale to Scranton a few years after his first settlement, and was for several years a merchant on South Main street. Later he became interested in Ohio steel and iron mills, but during the Civil War was obliged to relinquish his interest. He then became superintendent of the Lehigh Coal and Navigation Company's colliery at Lanford, later returning to Scranton and again engaging in business as a general merchant. He married Jane Leyshone. Children: 1. Albert B., cashier of the West Side Bank, Scranton; married Annie Hughes; children: Thomas A., Benjamin G., Howard. 2. Paul. 3. Thomas, deceased. 4. George Franklin, of whom further. 5. Jennie, married Dr. B. G. Beddoe, of Scranton; children: Ruth, Arthur, Allen.

George Franklin Eynon, son of Thomas Eynon, was born September 15, 1855, and is now a resident of Scranton, and a successful general merchant of that city. He married Kate Kramer, and has children: 1. Charles Augustus, married Bertha Davis; children: Helen May, George Franklin, Anna Louise. 2. Thomas Franklin, of whom further. 3. Jennie May, married H. S. McGarrah, of Scranton, Pennsylvania.

Thomas Franklin Eynon was born in Scranton, Pennsylvania, October 22, 1881. He obtained his preparatory education in the public schools of the city, then entered Lafayette College, whence he was graduated, class of 1905, with the degree of electrical engineer. After leaving college he entered the employ of the Westinghouse Electrical and Manufacturing Company, of Pittsburgh, going from that company to the General Electrical Company, at Lynn, Massachusetts. Returning later to Scranton, he entered the employ of the Delaware, Lackawanna & Western Railroad Company, as electrical engineer, then formed a connection with the Scranton Electric Company. On February 1, 1908, he entered into partnership with G. F. Smith as the Penn Electrical Engineering Company, the company later incorporating under the same name with V. A. Decker, president, G. F. Smith, vice-president, T. F. Eynon, treasurer, and O. I. Eberhardt, secretary. In connection with their business the firm are agents of the Westinghouse Electric and Manufacturing Company. The company's offices are No. 214 Traders Bank Building. The company is a prosperous one and as the name indicates executes all forms of electrical engineering contracts and mechanical equipment. Mr. Eynon is an Independent in politics, a member of the Congregational church, Peter Williamson Lodge Free and Accepted Masons, and the Royal Arcanum. His college fraternity is the Sigma Nu.

He married, June 1, 1910, Nora, daughter of George and Sarah Schutter Child, Thomas Franklin (2), born March 8, 1911.

## GUSTAVE FREDERICK SMITH

Three generations of this branch of the Smith family have resided in Pennsylvania. The American ancestor, John Frederick Smith, was a resident of Calw, Wurtemberg, Germany, from whence he came to the United States with his family in 1854, settling at Port Jervis, New York. Later he moved to Pleasant Mountain, Wayne county, Pennsylvania, thence to Seelyville, his home until death. He married Louisa Kermer and she had issue: Gustave, of whom further; Charles, deceased.

(II) Gustave Smith, son of John Frederick and Louisa (Kermer) Smith, was born in Wurtemberg, Germany, in 1838, died in Seelyville, Pennsylvania, March 3, 1914. He came to the United States with his parents in 1854, living at Port Jervis, New York, and Pleasant Mountain, Pennsylvania, before settling at Seelyville, Pennsylvania. There he was manager of the grocery and later the cheese firm of G. Smith & Sons, and spent his after life in successful business operations. With the exception of two years spent in New York his entire life in the United States was spent in Pennsylvania. He married Katherine Miller and she had issue: Charles, now residing in Honesdale; Katherine, married Reinhold Schank, of Hancock, New York; Louisa; Henry, married Mabel Reuny; Fred; Emma; Gustave Frederick, of whom further.

(III) Gustave Frederick Smith, youngest of the children of Gustave and Katherine (Miller) Smith, was born at Seelyville, Pennsylvania, October 18, 1881. His primary, intermediate and preparatory education was obtained in the public schools of Seelyville and Honesdale high school, he being a graduate of the latter institution, class of 1899. He then entered Lafayette College, Easton, Pennsylvania, whence he was graduated, electrical engineer, class of 1905. With a thorough technical knowledge of electricity he at once began its practical application. He spent three years in the "testing" departments of the General Electric Company at Lynn and Pittsfield, Massachusetts, continuing until 1908, when he came to Scranton. Here he organized the Penn Electrical Engineering Company in association with T. F. Eynon. They were successful in their undertaking, won the confidence of the public whose patronage they sought, and so increased their business that in 1910 they admitted O. I. Eberhardt, formerly with the Westinghouse Company, to the firm. In 1912 they incorporated with V. A. Decker, of the First National Bank of Holly, Pennsylvania, president; G. F. Smith, vice-president and general manager; T. F. Eynon, treasurer, O. I. Eberhardt, secretary and sales manager. The company's operations include many important contracts for modern electrical equipment, among them being the power plant, light and heating system installed for the Olyphant Barrel Company; the plant of the Honesdale Consolidated Light, Heat and Power Company and D. G. Derry Silk Mills; Bliss Silk Mills; Punxsutawney Silk Company; William A. Lush Silk Company; Haledon Throwing Company; Spencer Coal Company; South Side Coal Company; and the Washburne Williams Company. These contracts included all types of electrical motors, generators, engines, switches, etc., as well as the planning and all electrical engineering necessary to produce the best desired results. Mr. Smith is a practical electrical engineer, well versed in both theory and practice, and thoroughly understands the arrangement and installation of the various engines and devices needed to render a perfect power and light service for central stations, auxiliaries, mines, or industrial plants. In addition to their large contracting business, the company are jobbers of all kinds of electrical apparatus and supplies, also agents for Westinghouse Electric and Manufacturing Company. Their offices are in the Traders' Bank Building.

Mr. Smith is a member of the Engineers' Society of Northeastern Pennsylvania, the Exchange Club, of Honesdale, the Masonic Order, Delta Tau Delta Fraternity (Lafayette), also the Scranton Board of Trade. He is a Republican in politics, and a Presbyterian in religious faith.

---

#### ROSCOE H. KEFFER

While in the person of Roscoe H. Keffer the Aetna Life Insurance Company has an agent of but three years' standing, he has in that short time given ample proof of his merit and ability in that capacity. He is a native of Indiana,

a descendant of John Keffer, a native of Pennsylvania, born in 1784. John Keffer married Lucy, daughter of Isaac Gibbons, one of two brothers who came to America from Germany prior to the Revolution and took active part in that conflict as soldiers in the Continental army. From John Keffer the descent to Roscoe H. is through George, Harrison K., Monroe C.

Monroe C. Keffer, father of Roscoe H. Keffer, was born in 1856, son of Harrison K. and Phebe Keffer, who were the parents of three other children: Oscar, a resident of Missouri; Emma, married B. W. Bonney, of Washington, D. C.; Karl, a resident of Three Springs, Pennsylvania.

He spent his life in the pursuit of farming and school-teaching, the latter being his profession for twenty years of his life. He was a resident of Cottage Grove, Indiana. He married Ida, daughter of William Crume, who was a veteran of the Civil War

Roscoe H. Keffer was born at Cottage Grove, Indiana, May 20, 1882. His early life was that of most youths, spent in attendance at grammar and high school, from which latter he was graduated at the early age of sixteen years. He began his business career in Indianapolis, Indiana, in the same business as that in which he now engages, insurance, although the intermediate years have been spent as a commercial traveler, first in the employ of the Van Camp Packing Company and next with the Black Diamond Manufacturing Company. His terms of service with these corporations were two and eight years, respectively, and in 1911 he resigned his position with the latter company, coming to Scranton to accept the office of manager for the firm of Pursell & Dodd. In January, 1913, he purchased the interests of this firm and accepted the general agency of the Aetna Life Insurance Company, of Hartford, Connecticut, which he still retains. With his youthful experience in the insurance business as a firm foundation, Mr. Keffer is thoroughly familiar with all of the many branches of the insurance business, and has had remarkable success in selling the same. While, because of the lack of immediate and tangible benefits insurance selling is always a difficult undertaking, Mr. Keffer handles his proposition with graceful ease and ability, and has added greatly to the prestige of his company in that region. Mr. Keffer affiliates with the Masonic order, in which he holds the thirty-second degree, and is a member of the Knights Templar and the Shrine. His social connections are with the Temple Club, of which he is secretary, the Country Club, the Green Ridge Club, Scranton Club, and the Young Men's Christian Association. He is also a member of the Scranton Board of Trade. In religious belief a Methodist, he attends the services of that church, and politically he supports the Republican party. He married, July 1, 1905, Olive Eustice, granddaughter of John Eustice.

---

#### ALBERT N. KRAMER

The firm of Kramer Brothers, the largest and also the oldest men's and boys' outfitters in Lackawanna county, having been established by Nathan Kramer in 1849 in Dunmore, is now located at No. 325 Lackawanna avenue, Scranton, where they have successfully conducted business for more than half a century.

Nathan Kramer, the father of the Kramer brothers, and founder of the store by that name, came to the United States in boyhood, and became prominent and influential in commercial circles. At the time of his death, in 1875, the management of the business was taken up by his sons, one of whom, Louis N., now a resident of New York City, was active in Scranton affairs, serving in the capacity of vice-president of the Board of Trade, director of

Dime and Savings Bank, member of the Scranton Park Commission, and one of the early supporters and promoters of the Public Library of that city.

Albert N. Kramer, son of Nathan Kramer, was born in Scranton, Pennsylvania, August 24, 1864. He attended the public schools, thus acquiring a practical education, and in early life he entered his father's employ, there gaining a thorough knowledge of all departments of the business, of which firm he is now the senior member. Inheriting a strong, vigorous and flourishing business, he directs its management with a far-sighted, progressive policy, holding true to the standard of fair dealing established by his father. Mr. Kramer is a thirty-second degree Mason, belonging to Peter Williamson Lodge, Free and Accepted Masons; Keystone Consistory, and Irem Temple, Ancient Arabic Order Nobles of the Mystic Shrine, of Wilkes-Barre. His only other fraternal relation is with the Benevolent and Protective Order of Elks, of which he is a life member.

Samuel N. Kramer, son of Nathan Kramer, who was the junior member of the firm, died April 2, 1913. He was well known and respected by all who had the honor of his acquaintance. He was connected with several prominent financial institutions, and in his memory several institutions have benefited, the principal one being the West Mountain Consumptive Home of Scranton.

L. H. Kramer, son of Nathan Kramer, a member of the firm of Kramer Brothers, is active in the business and social life of the city of Scranton, a member of Scranton Commercial Club and Excelsior Club.

---

#### JAMES D. JORDAN

Among the lawyers of Scranton who have but recently joined the ranks of the legal profession is James D. Jordan, whose admission into the fraternity dates back but to 1911. He is a descendant of an old Irish family whose members are numerous in this country, and particularly in Pennsylvania, where many of the name have achieved noteworthy prominence in literary, scientific, professional and business life.

His grandfather, Richard Jordan, was born in the city of Ballina, county Mayo, Ireland, and came to the United States in 1849. He settled in Archbald, Pennsylvania, where he became a mine worker. Here he resided until 1890 when he changed his residence to Scranton, his death occurring in that city two days later. He married Bridget Hosie; children: 1. Thomas H., of whom further. 2. James, deceased, one of the proprietors of The Truth. 3. Richard W., until 1912 was manager of The Truth. 4. John H., manager of Lake Lodore Improvement Company. 5. Ella, deceased. 6. Mary, married John T. Swift, of Archbald. 7. Elizabeth. 8. Rose.

Thomas H. Jordan was born at Archbald, Pennsylvania, in 1851. During his early life he followed the occupation of miner. In 1874 he made his first residence in Parsons and there married Honora, daughter of Martin and Margaret (Kearney) Golden. Children of Martin and Margaret Golden: 1. Patrick, a merchant of Parsons, Pennsylvania. 2. Bridget, married Martin J. Walsh; children: Dr. James J., dean of the medical school of Fordham University and author of several works on Catholic themes, among his best known articles being "The Thirteenth the Greatest of Centuries" and "Popes and Sciences;" Dr. Joseph, a specialist in tubercular diseases, assistant to Dr. Flick at the White Haven Sanitarium, Pennsylvania; Martin P., a real estate dealer; Mary, married P. J. Jordan, of Scranton; Margaret, married John W. Jordan, of Olyphant, Pennsylvania; Josephine, a student at the Boston Conservatory of Music. 3. Mary, married Patrick Coxe, and died in 1901 leaving







Marcus A. Bishop

several children, among them Rev. John J., assistant rector of St. Patrick's Church, of Olyphant. 4. John, of Scranton. 5. Michael, a resident of Scranton. 6. Edward, lives in Parsons, Pennsylvania; his son, Rev. James J., is rector of St. Mary's Church of Wilkes-Barre, Pennsylvania. 7. William. 8. Catherine, married Michael Ruddy, of Parsons, Pennsylvania. 9. Honora, of previous mention, married Thomas H. Jordan. Children of Thomas H. and Honora (Golden) Jordan: 1. Rev. Richard D., pastor of St. Peter's Roman Catholic Church at Wellsboro, Pennsylvania. 2. Joseph P., an insurance broker of Scranton. 3. Martin J., pursuing theological studies at Mount St. Mary's Theological College, having already received the degree of A. B. from that institution, in 1913. 4. Mary E. 5. James D., of whom further. 6. Margaret M., a teacher in Scranton public school, No. 34. 7. Rose M., a teacher in Scranton public school, No. 12.

James D. Jordan was born at Parsons, Luzerne county, Pennsylvania, March 11, 1887. He attended the public schools of Parsons and Scranton, also the high school of the latter city, and there obtained his preliminary education, completing his studies at the University of Notre Dame, there receiving his classical instruction. On June 13, 1907, he received his A. B. from that institution and entered the Law School at the University of Pennsylvania. Here he studied until 1910 when he was registered as a student at law in the office of Mr. Warren, a lawyer of established reputation in Scranton, to whom Mr. Jordan owes much for his friendly interest and expert advice. On February 13, 1911, he was admitted to the bar of Lackawanna county and at once opened an office in the Connell Building, where he is still situated.

Although comparatively new to the profession, Mr. Jordan is a lawyer carefully prepared and well equipped for the heaviest of legal burdens and in the days to come should make good the promise of a brilliant future. In no other profession is honor and strength of character so certain to triumph over difficulties set for unwary feet, and with a past record beyond reproach the way to prominence and achievement looms bright and fair for Mr. Jordan. He is a Democrat in political affiliation, and a member of the congregation of St. Paul's Roman Catholic Church. He is president of the Young Men's Institute of the states of Pennsylvania and Maryland.

---

### MARCUS K. BISHOP

To Marcus K. Bishop, of Dunmore, has been accorded the honor of serving as postmaster under two presidents whose terms of office were as widely separated as were those of Andrew Johnson and William McKinley, both of which dignitaries appointed Mr. Bishop to that position in the government postal service, the former placing him in charge of the office at Hawley, Wayne county, Pennsylvania, the latter appointing him to the postmastership at Dunmore, Lackawanna county, Pennsylvania.

Marcus K. Bishop is of New England stock, son of David Bishop and grandson of Henry Bishop, his father a native of Albany, New York, his grandfather born in Connecticut. In 1812 David Bishop, accompanied by his five brothers, Henry, Harvey, Jacob, Hiram and William, made settlement in Wayne county, Pennsylvania, where he became the owner of considerable property, farming and conducting lumbering operations thereon, at one time disposing of two thousand acres of his property to the Pennsylvania Coal Company. His line is of Revolutionary ancestry, his great-grandfather, John Bishop, father of Henry Bishop, having fought in the Colonial army in that conflict. David Bishop was a member of the Universalist church, and a life-long Democrat. He married Maria Thurston, of Esopus-on-the-Hudson,

New York. Seven children resulted from this union, three of whom survive to the present time.

Marcus K. Bishop, son of David and Maria (Thurston) Bishop, was born in Hawley, Wayne county, Pennsylvania, August 19, 1839. He was educated in the Wyoming Seminary. His studies completed, he accepted the position of assistant postmaster at Hawley, Pennsylvania, which he held from the fall of 1860 until April 21, 1861, when he resigned to take up arms in defence of the Union. He became a sergeant in Company D, Fifteenth Regiment Pennsylvania Volunteer Infantry, and upon re-enlistment in the Union ranks became a member of the Ninth Regiment Pennsylvania Volunteer Cavalry, serving in that regiment until mustered out in Lexington, North Carolina, at the close of the war. From the front he returned to his home in Hawley, receiving from President Andrew Johnson the appointment as postmaster at Hawley, an office that he filled for two years. At the expiration of this time he resigned in favor of a war-time comrade who had lost a leg in the service of his country, Mr. Bishop accepting a position with the Pennsylvania Coal Company as a weigher. In 1869 he moved to Dunmore, being placed in charge of the Dunmore breaker owned by that company, and after serving for thirteen years in that capacity entered the office of the company as a clerk. In April, 1898, he was appointed postmaster of Dunmore by President William McKinley, an appointment that has since been confirmed by Presidents Theodore Roosevelt, William Howard Taft and Woodrow Wilson, so that the span of years between Mr. Bishop's first and latest appointment as postmaster has been extended from President McKinley to President Wilson. During Mr. Bishop's term of office Dunmore has received city delivery, the increasing population and the growing importance of Dunmore as a business center making necessary this arrangement, which was accomplished solely through the efforts of Mr. Bishop. Mr. Bishop is a member of Ezra Griffin Post, No. 139, G. A. R., and is a charter member of King Solomon Lodge, Free and Accepted Masons, of Dunmore. He and his family worship with the Presbyterian church, while he has been a life-long Republican.

Mr. Bishop married Janet Thomson, born in Carbondale, Pennsylvania, daughter of Samuel Thompson, her parents deceased. Children of Marcus K. Bishop and his wife: Edward, of Davenport, Iowa; Julia, married George Lisk, a postal clerk of Port Richmond, Staten Island, New York, now deceased; Anna, married Charles Penny, of Scranton, Pennsylvania, associated with the Daily News. The family residence is at No. 514 Fifth street, Dunmore, Pennsylvania.

---

#### ADOLF BLAU

One of the most interesting banking houses in northeastern Pennsylvania is that of the Blau Banking House, No. 218 Lackawanna avenue, Scranton. It is unique in more ways than one, its chief peculiarity being that on every week day the bank is open for business from 8 A. M. to 9 P. M., in pursuance of the motto of the institution, "Always convenient." Then, too, the departments of the bank distinguish it from any other of the financial houses of the city, or, indeed, of the state. A booking office is maintained, where passage in all three classes can be obtained on any one of the fifty-six steamship lines, many of them transatlantic and others following coastwise routes. The foreign exchange is also a department of special interest, inasmuch as foreign money may be exchanged for that of United States coinage or vice versa. A legal department, for the preparation of papers in the transaction of business abroad, is another distinctive feature of the Blau Banking House.

Because of the large number of foreigners patronizing the bank, there are clerks employed able to converse in every continental language, so that the foreigner, ignorant of English speech, can nevertheless be possessed of all the conveniences that would be open to him with a conversing knowledge of our tongue. Having given this brief outline of the workings of the Blau system, its originator and founder, Adolf Blau, known as one of the most progressive bankers of the state, must needs be mentioned.

Born in Ungvar, Austria-Hungary, on September 13, 1869, son of Joseph M. and Julia F. (Freidenberg) Blau, Adolf Blau was endowed with none of the gracious blessings of Providence. His father dying when Adolf was but ten months old, the lad was early thrown upon his own resources, and at the age of twelve years obtained a position in a store at Munkacs, where he remained for four years. On June 11, 1885, he sailed for the United States. After a few months' stay in New York, he came to Wilkes-Barre, where he was, for a time, identified with a firm conducting an installment business. He later engaged in the manufacture of hats and caps and while in this business started a small banking house. Finding the latter field to his liking, in 1898 he came to Scranton, and on October 1, 1898, opened a branch bank in Scranton. With the introduction of his new departures, the popularity of the institution grew by leaps and bounds, until the present three-story building, with a basement, was necessary to house it properly, the edifice being completed April 1, 1912. The entire building is used for the accommodation of the business, nineteen clerks being employed in its many departments. Taught by the difficulties he himself had to overcome when a stranger in the land, he has endeavored to bring the advantages of our banking system to all those of foreign tongue and has succeeded in an admirable manner.

Mr. Blau is a member of Centennial Lodge, Independent Order of Odd Fellows; Wyoming Valley Encampment; Wilkes-Barre Canton; the Benevolent and Protective Order of Elks, of Scranton; and Schiller Lodge, Free and Accepted Masons. He is also a director and president of the Brains Corporation and fills the same office on the board of directors of Luna Park.

Mr. Blau's story is that of many other ambitious youths, told in an entirely new way. Tireless perseverance and the ability to profit by experience, coupled with originality and self-confidence, have raised him far above the level of most of his countrymen as well as above that of many, in fact, of the majority, of Americans native born. Sending in advance his challenge, he has come to play on our grounds and has proven himself the superior of his opponents. His are the laurels, his the victor's wreath.

---

#### WILLIAM W. WATKINS

Patrons of music in the city of Scranton owe much to those bearing the name Watkins, a large share of the credit for the lofty position Scranton holds in the musical world being due to the efforts of the Watkins brothers, John T. and William W. It is with the latter of the two that this record deals, his career being of interest not only as one of Scranton's musical artists but as one of her business men, his pharmacy at No. 1213 Providence road being one well patronized, its proprietor a recognized master of his profession.

William W. Watkins, son of William W. and Jane (Jones) Watkins, was born in Merthyr-Tydfil, South Wales, May 20, 1865. His father was a railroad employee in that land and was the father of: Thomas W., a druggist of Olyphant, Pennsylvania, married Maria Evans and has children—Natalia and Vivien; Morgan J., a minister of the Baptist church in Pennsylvania, married Sarah Jane Neiger, and has children—Sarah, Jennie, Melissa, and William;

Sarah, married John W. Reese, a druggist of Taylor, Pennsylvania, and has—Eugene, Spencer, Chester, Everett, Leslie, and John; John T., a noted musician of Scranton, married Margaret Lloyd and had one son, Harold, deceased; William W., of whom further; James E., prominent in public life, married Mary Davis and has—Mercedes, Jean, and Dorothy, deceased; Charles, a druggist of Olyphant, Pennsylvania, married Jennie Davis; Annie; Richard, married Annie Beisecker, and is the father of Marion and Lois; Edith, married and is the mother of Dorothy and Edith; Gertrude, married and has one son, Ronald.

William W. Watkins was brought to the United States when he was four years of age, his family settling in Taylorville, three miles south of Scranton, where he was employed in the breakers and the mines. He continued in this form of labor until 1885, when he left the mines and entered the drug store maintained by Reese and Watkins. His general education had not been long continued or regular, obtained mainly when the mines were idle and at night, so he improved this and studied pharmacy under the tutelage of his brother, Thomas W. In 1888 Mr. Watkins opened a small drug store in Peckville, Pennsylvania, there remaining in business until the destructive fire of 1902, which completely wiped out the business section of the town. His present business location is at No. 1213 Providence road, Scranton, where he has erected a building designed for a pharmacy with dwelling accommodations above, where he and his family reside. His patronage is generous and he there attends to its needs with profitably gratifying results. His store is attractively furnished for its purpose, and he carries a generous stock of the numerous articles that have come to be inseparably connected with a pharmacy, the old drug store of other days being known no more.

Mr. Watkins is a musician of talent and a devoted follower of all of the important musical festivals, particularly of the Eisteddfod, and being the possessor of a rich and melodious baritone voice, has frequently competed in contest, his last appearance as a solo contestant being with the Scranton Choral Society at Brooklyn, New York, the society being under the leadership of his brother, John T. Watkins. This took place in 1902, Mr. Watkins being awarded the prize in the baritone contest. The only great contest at which he has not been present in the past thirty years was that recently held at Pittsburgh, which he was unable to attend. Mr. Watkins is a member of the Junger Mannerchor and is director of the chorus in the Court Street Methodist Church. The musical endowments that have so distinguished the family will find perpetuation in the two sons of Mr. Watkins, both of whom possess unusually sweet voices, and, Mrs. Watkins being a pianist of accomplished ability, the family comprises a quartette of remarkable musical talent. William W. Watkins is a member of the Scranton Choral Society; Union Lodge, No. 291, F. and A. M.; the Lackawanna County Druggists' Association; the American Druggists' Association, and St. Luke's Episcopal Church.

He married, in 1896, Gertrude, daughter of John Morris, for many years auditor of Lackawanna county. They are the parents of two sons, Morris, born in 1897, a graduate of the Scranton Technical High School, June, 1914; Torrington, born in 1902, a student in Public School No. 40, of Scranton.

---

#### ALFRED TENNYSON HUNT

Alfred Tennyson Hunt, an able banker of Scranton, Pennsylvania, is a descendant of a family which has been resident in America for a number of generations. Six brothers of the Hunt family came over with Cromwell's party from England, and one of these brothers was the forefather of Alfred

Tennyson Hunt. The name of Hunt is derived from the Saxon word, *Hunti*, meaning wolf.

(I) George Hunt, grandfather of Alfred Tennyson Hunt, as a wheelwright and general store keeper, was a most successful business man, and the qualities which contributed to his success appear to have been transmitted to his descendant in rich measure. He married (first) Dollie More, who bore him two children: James More and Elizabeth M. He married (second) Betty More, twin of Dollie More, his first wife, who bore him two children: Dollie, and Emma, deceased.

(II) James More Hunt, son of George and Dollie (More) Hunt, was born at Prattsville, New York, in 1841. In 1869 he removed to Scranton, Pennsylvania, where, having found employment, he brought his family and resided until his death in 1897. For a year or so he was engaged as clerk in the Continental Mine Store. Subsequently he formed a partnership with T. J. Megargel under the firm name of Megargel & Hunt, and opened a grocery store at the corner of Lackawanna and Washington avenues, which was conducted successfully for a period of ten years. He then engaged in business independently, and retired from active business pursuits in 1884. He married Mary Ellen Brandow, of Prattsville, New York, who bore him three children: Alice M., deceased; Bessie M.; Alfred Tennyson.

(III) Alfred Tennyson Hunt, only son of James More and Mary Ellen (Brandow) Hunt, was born at Prattsville, Greene county, New York, July 25, 1866. He was educated in the public schools of Scranton and graduated from the high school in the class of 1884, and during the last three years of his school life was employed as clerk in a grocery. After graduation he entered the local office of Dun & Company's Mercantile Agency as a clerk, advancing to the position of reporter, in which capacity he studied local credits and became familiar with the financial standing of the various business houses of Scranton, and remained with this company for a period of about three and one-half years, at the end of which time he decided to devote himself to banking and secured a position with the First National Bank of Scranton, December 1, 1887. During the first ten years of his employment with the bank Mr. Hunt filled various positions, and at the expiration of this period was appointed chief bookkeeper, in charge of the savings department, in connection with which he acted as substitute receiving teller, thus obtaining a general knowledge of practical banking. On April 4, 1908, he was appointed assistant cashier in charge of the credit department, in which capacity he is still serving and has the entire confidence of the officers of the bank and the esteem of his fellow workers. He is a member and trustee of the Green Ridge Presbyterian Church; member of the manufacturers committee of the Scranton Board of Trade, secretary and treasurer of the Electric City Land Improvement Company, and secretary and treasurer of the Scranton Land Company, a New York state corporation.

Mr. Hunt married, November 18, 1890, Jennie S. Durand, in Addison, New York. Their only child, Adelaide Durand, was born September 24, 1892.

---

### J. EDWIN WEISSENFLUH

While historians glibly assert that the path and course of civilization, culture and achievement moves westward, certainly for Mr. Weissenfluh, the course of all three has taken an eastward trend, although to a youth possessing to such a marked degree the qualities that he has displayed in school and business life, rules of historians or savants must needs lose the greater part of their effect. Born in Kansas, as a young man he came to the East, where all of

his advanced education was obtained and his business career passed. He is a son of a Swiss father, the third of a line of Johns, the first John, the great-grandfather of J. Edwin, having been a guide for Emperor Napoleon of France when, like Hannibal, he crossed the Alps and descended into the fertile plains of Italy. John, father of J. Edwin Weissenfluh, was born in Berne, Switzerland, and came to the United States in boyhood. The passage of events carried him to the West and for many years he engaged in the mercantile business. He married Emma Bosley, and had two children: Hilda, J. Edwin, of whom further.

J. Edwin Weissenfluh, only son of John and Emma (Bosley) Weissenfluh, was born in Wichita, Kansas, October 11, 1881, and there attended the public schools until he was seventeen years of age. From that time his education was earned solely through his own unaided efforts, the methods he employed to gain funds to enable him to secure adequate instruction along lines that he felt would be beneficial and the entire story of his winning fight for an education providing a story interesting in the extreme and one that arouses sincere respect for him who had the courage, fortitude and will power to pursue such a course to the successful end. In 1898 he moved to Scranton, there attending the high school, supporting himself by performing garden work in the summer and by caring for furnaces in the winter, on the grounds and in the homes of some of Scranton's prominent citizens. He was regular in his attendance at the Scranton High School, his outside duties being performed outside of school hours, and graduated from two of the courses offered by the curriculum, viz., commercial and English, completing seven years' work in four years, the first student ever to have accomplished this feat. His preparatory education successfully acquired, he then entered the University of Pennsylvania, enrolling in the Wharton School, a student in commerce and finance, completing in three years the work prescribed for four. His expenses at the University during this period were paid by the profits from a boarding club he established, and the second case in which his originality and initiative brought him concrete results. Thus fitted for a business career he returned to Scranton, entering the employ of the Scranton Dime Bank and later that of R. G. Dun & Company, mercantile agency, for the purpose of preparing himself for a brokerage business. On January 1, 1906, he accepted a position with Brooks & Company, investment bankers, as bond salesman, Mr. Brooks having an intimate acquaintance with his career, Mr. Weissenfluh three years previously having tended his garden. For five years he was employed in the office of this company, and at the expiration of that time was admitted to a partnership in the firm. There is little doubt that, endowed with the qualities that have made his career thus far one of brilliant success, Mr. Weissenfluh will not lower the ideals that he has set up as a standard, and that future years should bring him a goodly yield of prosperity and happiness, richly deserved.

Mr. Weissenfluh is a member of Alpha Tau Omega Fraternity, to which he was elected while at College, the Scranton Club, the Scranton Country Club, the Green Ridge Club, the Westmoreland Club and the Franklin Club, of Wilkes-Barre, the University of Pennsylvania Club of New York City and the Manufacturers' Club of Philadelphia. In all of these organizations he is an active member, retaining a love of athletics and outdoor life from his college days, when, besides loyally supporting all of the college teams, he was a member of the varsity football team and wrestling teams. He was also instrumental in the organization of the Intercollegiate Wrestling Association. Mr. Weissenfluh is also connected in an official way with many corporations, being president of the North Michigan Water Company, and also of the Cochocten Light and Power Company, and vice-president of the Central Realty Company.



Mr. Weissenfluh married, in April, 1906, Mary L. Greeley, a relative of Horace Greeley, of editorial and political fame. They are the parents of a daughter, Hilda, born in 1907.

---

#### WILLIAM E. GILHOOL

Ever since the arrival in the United States of Timothy Gilhool, the name has been connected with manufacturing interests in Pennsylvania, William E. Gilhool continuing in Scranton a business founded by his father. This branch of the name is of short residence in the United States, Timothy Gilhool having been born in Ireland, whence he came to Susquehanna county, Pennsylvania, there obtaining work in a shop. He later moved to Wilkes-Barre and was there employed until 1870, in which year he came to Scranton and opened a wagon and blacksmith shop on Lackawanna avenue, at first in a small way, but being industrious and gaining a reputation for square dealing the business grew to large proportions. To Timothy Gilhool belongs the distinction of having built the first hose wagon used by a fire-fighting force in the city of Scranton, a vehicle manufactured in his shops on Lackawanna avenue, a site now occupied by the Delaware & Hudson Depot. Timothy Gilhool married Mary Murray, and had children: William E., of whom further; John H.; Thomas F.; Anna, deceased; Edith. Mr. Gilhool died in 1883, and Mrs. Gilhool died in 1904.

William E. Gilhool, son of Timothy Gilhool, was born in Wilkes-Barre, Luzerne county, Pennsylvania, October 23, 1858. He was brought to Scranton by his parents, in which place he attended the public schools, completing his studies with a high school course. He then entered his father's wagon and blacksmith shop, later learning wagon-making, and in 1890 became proprietor of the business, manufacturing wagons and auto trucks, having to his credit the manufacture of the first auto bus made in Scranton. His present factory is at the corner of Walnut street and Washington avenue, the home of an industry, one of the oldest of its kind in the city and one of the most flourishing. The name Gilhool on wagon, truck, carriage or fire apparatus stands for quality, forty-four years of success telling the story better than words. The designing of automobile busses and automobile bodies are specialties with Mr. Gilhool, also painting. Mr. Gilhool and his brother, John H. Gilhool, were members of the Nay Aug Fire Company, which at its organization was unable to obtain money from the municipal government for the purchase of equipment and consequently was compelled to buy its own engine and horses to draw it.

Mr. Gilhool married Catherine Gearns, and has one son, Joseph. Residence, No. 1531 Capouse avenue.

---

#### EDGAR A. FENSTERMACHER

A musician of innate talent, Edgar A. Fenstermacher is known to Scranton not only as a talented performer upon several musical instruments, but as a dealer in such instruments. He is a noted pipe organist and has played in several churches for the past fifteen years. Thus he is acquainted in the artistic world of Scranton, for the city has many patrons of the arts, and in the commercial world of the same city, and holds high reputation in each. Mr. Fenstermacher was born in Wapwallopen, Luzerne county, Pennsylvania, son of Michael W. and Josephine (Everard) Fenstermacher, grandson of William and Rebecca (Hess) Fenstermacher, and great-grandson of Philip and Rachel (Harter) Fenstermacher. William and Rebecca (Hess) Fenstermacher were the parents of: Michael W., of whom further; Pauline, married Daniel

Snyder; Catherine, married Peter Good; Saville, married Jacob Hippenstel; Parmelia, married Philip Peters; Marie, married Philip F. Peters; Sarah, married Aaron Bittenbender.

(II) Michael W. Fenstermacher, son of William and Rebecca (Hess) Fenstermacher, was born in Wapwallopen, Luzerne county, Pennsylvania, and was engaged in mercantile pursuits throughout his active life, retiring from business in 1907. His wife, Josephine, was a daughter of George Everard, of Hobbie, Pennsylvania, and they were the parents of children: Edgar A., of whom further; Scott E., a jewelry and automobile dealer of Berwick, Pennsylvania, married Laura Snyder and has two children, Leroy and Loletta; Carrie, married Charles Andres and has one son, Dale.

(III) Edgar A. Fenstermacher, son of Michael W. and Josephine (Everard) Fenstermacher, was born April 5, 1871. He obtained a general education in the public schools of Luzerne county. As a youth he began the study of music, pursuing the same under private direction for nine years, after which he was for one year a student in the Philadelphia Musical Academy. Until 1892 he was a teacher of music, his pupils residents of his native town and neighboring villages. In that year he moved to Nescopeck, continuing as an instructor in music and at the same time holding position as choir director and organist in the Methodist Episcopal church at Berwick, Pennsylvania. Six years later, in 1898, Mr. Fenstermacher came to Scranton, and was for three years associated with N. A. Hulbert, a piano dealer of the city, at the end of that time becoming connected with J. W. Guernsey, proprietor of one of the largest musical instrument stores in the city. In 1907 he entered this line as an independent dealer, and the seven years that separate that time and the present have witnessed the upbuilding of a flourishing and substantial trade, to which Mr. Fenstermacher has applied himself with energetic enthusiasm. His line includes pianos, mechanical players, all styles of talking machines, and varied wind and string instruments too numerous for mention, while the best musical scores and shorter compositions are a part of the stock carried.

Mr. Fenstermacher, for the past nine years, has been organist and choir director of the Asbury Methodist Episcopal Church. Not only is he an accomplished entertainer, but is skilled in the choice of vocal performers and their training, the musical programs of the Asbury Methodist Episcopal Church making the service one most beautiful and impressive. He is also one of the members of the official board. His artistic prominence and his business success have advanced hand in hand, the one furthering the other, he and his patrons finding a common interest in their musical tastes, a means of intercourse being thus established that would be impossible to the majority of proprietors or salesmen, however excellent their ability.

He is a Republican in political choice, and holds membership in the Asbury Methodist Episcopal Church. He fraternizes with the Benevolent and Protective Order of Elks, Green Ridge Lodge, Independent Order of Odd Fellows, the Patriotic Order Sons of America, and holds the thirty-second degree in the Masonic Order, his lodge being Union, No. 291, F. and A. M., and in this society he belongs to Keystone Consistory, thirty-second degree, Ancient Accepted Scottish Rite, and to Irem Temple, Ancient Arabic Order Nobles of the Mystic Shrine.

Mr. Fenstermacher married, at Lee, Pennsylvania, Alvert A., daughter of William F. McQuown, of Warrior Run, Pennsylvania. Mr. and Mrs. Fenstermacher are the parents of: Marqueeene A., born in 1897; Arline A., twin of Marqueeene A., Edgar A. Jr., born July 11, 1911.

## GEORGE FELTON

A Scrantonian by birth and almost constant residence, Mr. Felton, one of the successful business men of the city, has achieved that success by an energy and ability that stamps him as a citizen of whom his native city may well be proud to acknowledge as one of her sons.

George Felton was born in Scranton, at No. 129 Penn avenue, May 27, 1868, son of Peter Felton, and maternal grandson of George Keller, the latter a native of Alsace-Lorraine, then under French rule. George Keller came to the United States in 1840, located at Utica, New York, where he followed the trade of stone cutter the remainder of his life. He married, in 1842, Margaret Schug, of St. Johnsville, New York, born there in 1826. Children: Mary, who became the wife of Peter Felton; George (2), deceased; Margaret, deceased; Sophia, married N. Albicker; John, a resident of Scranton; Anna, married a Mr. Werthman, of Utica, New York.

Peter Felton, born in Cologne, Germany, in 1831, came to the United States in 1850. Soon after his arrival he learned of the discoveries of precious metal in the West and joined a company of "gold seekers" bound for California. He spent several years in the gold fields with varying success, then joined a government surveying expedition bound for Alaska. He spent ten years in that, then little known, northern land, finally returning to the United States and settling on a farm in the state of Wisconsin. In 1866 he moved to Utica, New York, where he engaged in teaming and draying in partnership with his wife's uncle, Nicholas Schug, and continued there until 1867. In 1868 he came to Scranton, entered into partnership with George Keller and was associated with him for one year, when he returned to Utica and engaged in the same line of business which he conducted successfully up to 1895, when he retired and so lived until his death in 1902. He married Mary, daughter of George Keller, and had issue: George, of whom further; Margaret, married Henry Hoffman, of Utica, New York; Anthony P., a merchant of Madison, Wisconsin; Sophia, a resident of Utica; Gertrude, also a resident of Utica.

George Felton was educated in a private school at Utica, New York, and at the Academy of the Assumption, of the same city, from which latter institution he was graduated in 1882. After completing his studies he came to Scranton, Pennsylvania, where he learned the trade of locksmith, engaged in the cutlery business as clerk, working for George Keller until 1889, when he began business for himself at No. 226 Spruce street, dealing in all kinds of cutlery and sporting goods, also continuing locksmithing. His store became very popular and his trade so large that he sought a location where he could accommodate his rapidly increasing trade. This he found at No. 136 Penn avenue, but eight months after occupying his new and enlarged store, it proved wholly inadequate, and he again sought larger quarters. This he found at the corner of Penn avenue and Spruce street, where he remained until 1899, when he purchased the store and business of George Keller at No. 119 Penn avenue, where he yet remains. While he has been engaged in business since 1889 and has made the several moves in locations noted, his stores have all been in the same city block. George Keller and Peter Felton were in business as partners at the present location from 1868 to 1869, George Keller continuing until succeeded by George Felton. The present business is a most prosperous one, Mr. Felton having made his store wherever located, headquarters for the cutlery and sporting goods trade. Himself an expert lock and gunsmith, this has ever been an important department of his business and one that he has built up to large proportions. He is popular with his trade and by practicing the "square deal" in all things has become a recognized leader in his line of

business. He is a member of the Scranton Bicycle Club; the Scranton Liederkranz; treasurer of Camp No. 63, United Sportsmen of Pennsylvania; member of the congregation of St. Peter's Cathedral (Roman Catholic) and an Independent in politics.

Mr. Felton married, in 1892, Catherine, a daughter of William Servatius, the latter a druggist at Utica, New York, now in his seventy-fourth year. Children: Mary Antoinetta, born April 4, 1893; Theodore G., May 15, 1894, now deceased; William P., February 2, 1897; Ruth Catherine, July 14, 1901; Carl Robert, August 27, 1908.

---

#### PETER STIPP

A story of real attainment, of steady progress from humble circumstances to an important, honorable and commanding position, a height gained not by a meteoric rise, but by gradual, constant advance, is that of Peter Stipp, one of the leading contractors of Scranton. An industrious, hard working Teuton, the secret of his success is an open one, and based upon the gospel of labor, a religion never deserting its followers, but ever leading them on across the Jordan of adversity into the Canaan of reward.

Peter Stipp, son of Ludwig and Mary Anna (Diedrich) Stipp, was born in Rheinpfalz, Germany, September 30, 1858. His father was a contractor, conducting operations in a small way, and Peter Stipp learned the trade of mason and brick-layer, following this while he was a young man. In accordance with the regulations of the German government, he served in the army, attaining the highest rank open to first enlistment men, that of corporal. About 1881 he came to the United States and settled in Oxford, New Jersey, coming to Scranton a year later. Here he established in business for himself, applying himself to his occupation with the undivided concentration that characterizes his race, gradually acquiring larger and more profitable interests. Prosperity seemed to come to him in such an unpretentious manner that to define the different periods in the accumulation of his fortune and the formation of his varied connections is most difficult. Soon after starting upon building operations, he opened a quarry near Olive and Colfax streets, from which he procured much of the stone used in building as well as a large amount of broken stone for use in concrete work, which, in view of its newly demonstrated efficiency, is becoming extremely popular as a building material. He sells part of the quarry's output of local trade, employing about forty-five men in the quarrying of the product. In his different operations throughout the city, Mr. Stipp employs a force of about fifty-five men. Some of the Scranton buildings erected by him are the First Presbyterian Church, the Guernsey Building, the Petersburg Presbyterian Church, the Myrtle Street Methodist Episcopal Church, and the office building of the International Correspondence Schools, generally recognized as one of the most beautiful buildings in the city. In 1910 he purchased the Scranton Vitrified Brick Company, manufacturers of paving brick, a concern employing about sixty people. A trait that has characterized Mr. Stipp's business career is that he has never been contented with the more modest forms of his contracting operations, but has ever reached upward and gained control of the very fountain heads of his business.

Mr. Stipp is prominent in Masonic circles, holding the thirty-second degree, and is a member and past master of Schiller Lodge, Free and Accepted Masons; Lackawanna Chapter, Royal Arch Masons; Melita Commandery, Knights Templar, of which he is captain general; Keystone Consistory, Sovereign Princes of the Royal Secret, and is a noble of Irem Temple, Nobles of the Mystic Shrine. He is also a member of the Krieger-Verein, an organiza-



*John H. King*







Ludwig T. Stepp



tion composed of soldiers who have seen service in the Kaiser's army; the Liederkrantz; the German American National Alliance, of which he is a life member, and of the Lackawanna branch of the German American Alliance, of which he is president. He is a director of the Builder's Exchange. His political allegiance is given to the Republican party, and for six years he has served on the Scranton Select Council, and is now a member of the City Planning Commission. He and his family are all allied with the German Lutheran church.

He married Lena Wehrung, a native of Scranton. His two sons, Harry and Peter Jr., are associated with him in business. Mr. Stipp's career has been one of usefulness to the city of Scranton. With her best interests he has become permanently identified and his part in her growth has been well and manfully borne. His fine social qualities, genial disposition and unswerving loyalty to his friends have gone far towards assisting in placing him among the foremost of Scranton's reputable business men. The courteous manner in which he receives every one, be they strangers or old friends, make it a pleasure to be in his society.

---

#### LUDWIG T. STIPP

Ludwig Theobald Stipp is the third member of the Stipp family who has attained prominence in the field of contracting and building in the city of Scranton, the others being his brothers, Peter and Matthias.

Ludwig T. Stipp, son of Ludwig and Mary Anna (Diedrich) Stipp, was born in Rheinpfalz, Germany, October 23, 1870. His father conducted a small contracting business, and under his preceptorship Ludwig T. laid the foundation for his trade when only a youth. When he was but thirteen years of age he spent eighteen months in England, Ireland and Scotland with the German Band, and in the spring of 1886 came to New York and later to Scranton, Pennsylvania. He came to this country also with the German Band. At Scranton he was employed and finished his trade. Being then seized by a wandering spirit and a desire to see more of the new land to which he had come, he traveled for a time, following his occupation up to twenty years of age, when he was made foreman. In 1890 he returned to Scranton and for fifteen years was foreman and general superintendent in the employ of his brother, Peter Stipp, discontinuing his connection in that capacity in 1905, when he established in independent business. In this enterprise he has met with a great deal of success, and has erected many public buildings as well as private dwellings in the city. Some of the edifices whose construction he supervised are Hyde Park School No. 41, School No. 42 at Colfax and Mulberry streets, the Administration Building, the Pennsylvania Baking Company Building, the Duryea High School Building, the Keystone Bank Building, the city stables, the electric sub-station at Carbondale and the store-house and office building of the Scranton Electrical Company. He now has in process of building the illuminating plant of the Scranton Electrical Company, the large boiler plant of the Electrical Company, the cooling tower plant of the Electrical Company, which is the largest in the state, the Van Dyke Piano factory, the Keller-Dunham Piano factory, and in addition numerous other buildings.

Mr. Stipp is a thirty-second degree Mason, and is past master of Schiller Lodge, Free and Accepted Masons; also belonging to Lackawanna Chapter, Royal Arch Masons; Coeur de Lion Commandery, Knights Templar; Keystone Consistory, Sovereign Princes of the Royal Secret; and is a noble of Irem Temple, Nobles of the Mystic Shrine. He is also a member of the Benevolent and Protective Order of Elks, the German American Alliance, the Builders' Ex-

change, the Scranton Club, the Board of Trade, the Liederkrantz, of which he has for four years been president. With his wife he is a member of the German Lutheran church.

Mr. Stipp married (first) Carrie, daughter of Charles Raffeld, who died in 1900, a daughter, Annie E., surviving her. He married (second) Kathrina, daughter of Heinrich Falk, of Hessen Darmstadt, Germany; children: George L., who died at five years of age; Elizabeth, Louisa.

Ludwig T. Stipp has gained a high position in the society of Scranton, and is honored and respected for his uprightness of character. His success has been through the same medium that characterized the progress of his brothers, intelligently and conscientiously applied effort.

---

### JACOB BESSMER

The earliest ancestor of this branch in America is John D. Bessmer, born in Germany, who came to the United States, landing in New York City, and in 1849 joined the gold-seekers in their California journey. Since then all trace of him is lost.

(II) Christopher D. Bessmer, son of John D. Bessmer, was born in Germany and came to this country when young. He became a contractor and with his uncle contracted the erection of portions of both the Second and Third avenue elevated lines in New York City. Later he located in Scranton, becoming superintendent in charge of the rolling mill of the Lackawanna Iron and Steel Company. He retired from the steel business several years ago and purchased the farm upon which he now resides. He married Charlotte Schmidt, and has issue: John C., Christian B., Jacob, of whom further, Christina C., Frederick D., Anna.

(III) Jacob Bessmer, son of Christopher D. and Charlotte (Schmidt) Bessmer, was born in Scranton, Pennsylvania, November 13, 1882. He obtained his education in Scranton and New York schools. He served a three years' apprenticeship at the trade of machinist, working in Scranton. From here he went to Bridgeport, Connecticut, entering the employ of the Locomobile Company, and spending two years with that company as traveling salesman. Returning to Scranton, he organized the Economy Automobile Company and the Lackawanna Vulcanizing Company, being president of both companies since August, 1907. Mr. Bessmer thoroughly understands his business and has been uniformly successful. He is a member of the Masonic order and of the Independent Order of Odd Fellows. He married, June 12, 1907, Mary Elizabeth, daughter of David Seal. Child, Edward D., born September 22, 1909.

---

### GEORGE HOWELL WINANS

For more than half a century one line of business has been followed by two generations of the Winans family in Scranton, sign-painting, George Green Winans, father of George Howell Winans, being the first artisan in Scranton to follow that craft. Since 1886 that has been the calling of his son, George Howell Winans, the scope of his business a wide one, extending throughout the entire Scranton district. For years the name Winans has appeared as the executor of striking and attractive advertising features, and the business conducted by Mr. Winans at the present time holds prominent position among other concerns engaged in the same line.

(1) New Jersey residence was owned by this family prior to its settlement in Pennsylvania, Elibu Winans, grandfather of George Howell Winans, having been a native of Elizabeth, in that state. He moved to Scranton, there mar-

ried, and for nearly all of his active life was connected with the Delaware, Lackawanna & Western Railroad Company in the capacity of tinsmith. He married Charlotte Randolph, one of his sons being George Green, of whom further.

(II) George Green Winans, son of Elishu and Charlotte (Randolph) Winans, was born at Belvidere, New Jersey, in 1839, died in Scranton, Pennsylvania, in 1907. His occupation was that of sign painter, as has been previously stated, and this he followed for a time in Philadelphia, in 1860 moving to Scranton. He was the first of his calling in the city and in connection with sign painting conducted paper hanging and general painting operations, his working force frequently numbering thirty men. He was the owner of a slate quarry, which was operated under his direction and from which he realized a generous revenue, and became the owner of a tract of land known now as the "Winans Addition," the site of numerous dwellings, the extension of the city limits having included that within Scranton's boundaries. Mr. Winans was of a mechanical and inventive turn of mind, and secured patents upon a ladder and a window jack, both of which he had been perfecting when he found a few leisure moments, free from the press of business. He married Hannah (Hughes) Howell, widow of Thomas Howell, who was, with her brother, owner of the Mount Pleasant mines. By her previous marriage she was the mother of: Henry T., died in Pittsburgh, Pennsylvania, in 1913, married Jessie Frink and had one son, Albert W.; Lizzie, married William H. Schliffer, of Brooklyn, New York. Mr. and Mrs. Winans were the parents of: Minnie, married W. K. Richart, of Scranton, and has two children, Howard and Mary; George Howell, of whom further.

(III) George Howell Winans, son of George Green and Hannah (Hughes-Howell) Winans, was born in Scranton, Pennsylvania, March 26, 1867, and was a student in the public schools of the city of his birth until he was fourteen years of age. He then became employed in the bookkeeping department of the concern maintained by O. S. Johnson, a coal operator of Dunmore, where he remained for one year. The following year he passed with the Scranton Supply and Machine Company, his next employment being with the Hunt and Connell Company, with which he was connected until 1886. In that year Mr. Winans became a sign painter of Scranton, in which he continues with eminent success to the present time, his business being located at No. 430 Lackawanna avenue. During his career in this business sign board advertising has attained high popularity, and because of the excellence of the work performed by his house and the ability of the artists employed Mr. Winans has been awarded a large share of the commissions of this nature given in the Scranton region, work bearing his name greeting the eye of the observer over a wide expanse of territory.

Mr. Winans is a member of the Court Street Methodist Episcopal Church, and affiliates with the Democratic party. As a citizen he has a keen realization of the duties of the word implies, and in sympathy and effort is always allied with projects for the advancement of Scranton's interests along any line. By his business associates he is respected as a man who has accomplished much without ostentation and who has ever adhered to strict and upright principles in dealing with his fellows. He married Sadie E. Ruch and has one son, Reginald, born February 21, 1903.

---

#### HERMAN F. STENDER

The family of Stender is one of comparatively recent arrival in the city of Scranton, founded in this city by Ferdinand John Stender, father of Herman

F. Stender, of the firm of Hower & Stender, lumber merchants of Scranton, in 1886. The family is of German lineage, Schoefliesz, Kreis Bernt Reg. Danzig, West Prussia, having been its home in that country. Ferdinand John Stender was a son of Gottlieb Stender, who married Rahl Karnath and had children: Ferdinand John, of whom further; Wilhelmina, Augusta, Amalia, Frederick.

Ferdinand John Stender was born in Schoefliesz, Kreis Bernt Reg. Danzig, West Prussia, December 27, 1837, and there he was reared to the life of a farmer, in 1866 bringing his family to the United States and settling in Scranton, there obtaining railroad employment. He married Augusta, daughter of Ludwig and Caroline Zielke. Children of Ludwig and Caroline Zielke: Henrietta, Karl, Ferdinand, Amalia, Augusta, of previous mention, married Ferdinand John Stender, and Herman. Children of Ferdinand John and Augusta (Zielke) Stender: Hulda, married William Steinbrugge, and is the mother of Ida, Frederick, Karl, Marie; Herman F., of whom further; Bertha, married Edward J. Freis, and has children, Hilda, John, Albert, Lailas; Ida, married Leverne B. Loyn, and has Mildred, deceased, and Jack Jerome; Augusta, married George Yonker, and is the mother of Marjorie, Dorothy, Robert, deceased; Marie, married Albert Motiska, and has Alice and Ruth; Selma, died on ship-board while journeying from Germany to the United States, aged five years, and was buried at sea; Ferdinand G.; Karl W.

Herman F. Stender, son of Ferdinand John and Augusta (Zielke) Stender, was born in Schoefliesz Kreis Bernt Reg. Danzig, West Prussia, April 17, 1872, and was educated in the schools of his native land, at the age of fourteen years accompanying his parents to the United States. His first six months' employment was as a slate-picker in a breaker, after which he was for one year employed in a glass factory, then accepted a situation as private coachman in the establishment of Herman Werrum, superintendent of the Lackawanna Iron and Steel Company. He subsequently became associated with John D. Kohl, of Scranton, under him learning the trade of carpenter, after three years becoming Mr. Kohl's foreman, a position he retained when the latter gentleman became general superintendent of the Peck Lumber Manufacturing Company. On April 1, 1896, John D. Kohl and Mr. Hower formed a lumber dealing partnership, Mr. Stender being engaged as foreman, and upon Mr. Kohl's death, February 3, 1897, Mr. Stender purchased his interest in the business, under the firm name of Hower & Stender, as general contractors and builders, two years later entered into the general lumber business and manufacturers of building material. The firm's trade is a large and lucrative one, and although competition in that line is keen, the firm has more than retained its share of the business throughout the Eastern states.

Mr. Stender is president of the Builders' Exchange, of Scranton, and is a director of the Anthracite Trust Company and the German Building and Loan Association No. 10. He is a thirty-second degree Mason, belonging to Schiller Lodge, No. 345, F. and A. M., Fairview Lodge, No. 369, K. of P.; and holds membership in the German Alliance and the Liederkrantz. His church is the German Presbyterian, and in matters political he takes an independent stand. Mr. Stender married Wilhelmina, daughter of Peter and Louise (Engel) Schafer, and has children: Bertha, born May 1, 1898; Helen, January 21, 1906; H. Gilbert, August 9, 1910.

---

#### ROBERT C. RUTHVEN

Robert E. Ruthven, who was at one time a member of the Massachusetts state legislature, came to Baltimore from Scotland, the family home, and later settled in Boston. He became well known because of his political achieve-

ments and was a member of the most select social circles of that city. His son, Robert E. Ruthven, was troubled throughout his early life by an extremely weak constitution. Sea air seeming particularly beneficial to him, he spent three years as purser of the mercantile vessel, "Jonathan," one of his several long and perilous voyages being around Cape Horn. Much improved in health by the exposure to natural elements that the life necessitated, he once more took up residence ashore and obtained a position on the engineering staff of the New York Central Railroad. His first home was in Carbondale, but about twenty years before his death he moved to Scranton, spending his later years in the coal department of the Delaware, Lackawanna & Western Railroad Company. With his wife he was a member of the Presbyterian church. He married Sarah, daughter of Parley Goddard, of Worcester, Massachusetts. She was a graduate of Mount Holyoke College, South Hadley, Massachusetts, died 1912, aged eighty-two years.

Robert C. Ruthven, son of Robert E. and Sarah (Goddard) Ruthven, was born in Scranton, Pennsylvania, March 31, 1862. He was educated in the public schools of the city, also attending "Daddy" Merrill's School. The profession of civil engineering was the field that appealed to him more than other callings, and after his technical training was completed he obtained a position on the engineering corps of the Delaware, Lackawanna & Western Railroad, his connection with that company ending with the completion of the Buffalo, Binghamton branch. He was then for twenty years associated with the Barber Asphalt Paving Company, until 1904, when he began independent paving operations. Pennsylvania and New York comprise his territory, and throughout those states he has done a great deal of work which bears mute testimony to the skill of the contractor by the excellent condition of the roads several years after their completion. Mr. Ruthven has become one of the leaders in his chosen occupation, success predicated entirely upon popular approval of the quality of his work. There is probably no line of activity in which the workman is judged more purely upon his merits than his and his attainment there is the result of superiority in the science and practice of road paving. He is secretary and treasurer of the Ariel Sand Company of Scranton, in the organization of which he played an important part. With his wife he is a member of the First Presbyterian Church of Buffalo.

Mr. Ruthven married Anna, daughter of Stephen Hopkins, of Waverly, New York; children: Robert Stanley, an attorney of Buffalo, New York; Henrietta, a graduate of Wellesley College, class of 1913.

---

#### OTTO P. MILLER

The two members of the Miller family, the story of whose lives enters into this chronicle, were both of German birth, Otto P. and his father, C. August Miller, having been born in Leipsic, Saxony, Germany. C. August Miller was born December 28, 1805, and in 1848 he immigrated to the United States with his family, landing on the American shore on October 30. He at once made settlement in Archbald, Pennsylvania, where he resided until his death, April 9, 1878. His trade was that of carpenter, and during the thirty years that he lived in Archbald he gained a deserved reputation as a man of upright life and a citizen strong in all the obligations carried with the word. He married Caroline Muer, and had children: 1. Pauline, married Valentine Gerbig. 2. Herman C., a soldier of the Union army in the Civil War, company color corporal in Company H, Fifty-second Regiment Pennsylvania Volunteer Infantry, serving from 1861 to 1864; secretary and treasurer of the Fifty-second Regimental Association since its organization in 1888; married Anna, daughter

of Captain McLeod, of Carbondale, Pennsylvania, and has sons, Albert, an undertaker of Kingston, Pennsylvania, and Willis, a plumber of the same place. 3. Elizabeth, deceased; married John Ulmer, a veteran of the Civil War, and had a daughter, Annie, married William Morgan, of Carbondale, Pennsylvania. 4. Elvina, married Henry Neymier; children: Charles, an instructor in the Scranton High School, Fred, Helen, Clara, a school teacher. 5. Theodore M., married and had a daughter, Gertrude, who married John, son of Colonel Hitchcock. 6. Otto P., of whom further. 7. Emma, married Charles Millhouse, deceased, of Archbald, Pennsylvania; three children. 8. Amelia, the first American-born daughter of her parents, married Captain C. C. Battenburg. 9. Carrie, married Richard Callaway. 10. August, resides in Stroudsburg, Pennsylvania.

Otto P. Miller, son of C. August and Caroline (Muer) Miller, was born in Leipsic, Saxony, Germany, November 5, 1845, and when five years of age was sent to the United States with friends to his parents who had come in 1848. When he was sixteen years of age he became a trade apprentice in Carbondale, Pennsylvania, after three years moving to Philadelphia, there being employed as a journeyman. In 1865 he moved to Harrisburg, remaining there for a short time, then returned to Philadelphia, and for two years engaged in the barber trade, moving to Scranton in 1867, entering the barber shop of Charles Spiker. Not long after arriving in Scranton he established in that business independently, opening a shop in Providence, where he has been continuously engaged until the present time (1914). Mr. Miller took out his naturalization papers soon after coming to Scranton, these documents bearing the signature of the city clerk, Daniel Ranker, and the date of September, 1868. He has been active in the life of the city, and on November 10, 1868, was one of the organizers of the Liberty Hose Company, a project in which he was encouraged and aided by T. V. Powderly, at that time mayor of the city. Mr. Miller later, under the administration of the later Ezra Ripple, becoming district engineer of the fire department. In the year 1883 he was a member of the school board, and in 1890 became a member of the select council, holding a seat therein for four years. His career has been a busy and a useful one, and in all departments of the municipal life to which he has been called he has rendered willing and efficient service, giving to each position that he has held the best of his ability. He is prominent fraternally, being treasurer of the Improved Order of Heptasophs, and is the only living charter member of Celestial Lodge, Independent Order of Odd Fellows, having held nearly all of the offices of the lodge, now past grand. Through virtue of his long membership he holds the Veteran Jewel of the order, and is a member of the Scranton Encampment of the same order. His political sympathies are Democratic.

Mr. Miller married Jeanetta, daughter of Alexander Bryden, the first mine foreman of Carbondale, and a sister of the late Andrew Bryden. Mr. and Mrs. Miller are the parents of five children: 1. Carrie, married George Pyle, a resident of Yonders, New York. 2. Jessie, married George A. Dickerson; lives on Madison avenue, Scranton; has a daughter, Evelyn. 3. Frank, a resident of Berwick, Pennsylvania. 4. Ernest, associated in business with his father. 5. Harry, engaged in automobile dealing in Chicago, Illinois; married Susie Fisher, and has one daughter, Janet.

---

#### MATTHEW A. COAR

Educated and trained for his business in Philadelphia, Matthew A. Coar has since his independent establishment in stock and bond dealing been a broker

of Scranton, his birthplace. He is a son of John P. Coar and a grandson of Thomas Coar, his grandfather a merchant of Scranton, also for a time employed in the shops of the Delaware, Lackawanna & Western Railroad. He was at one time member of Scranton council from the twenty-first ward, elected as the Democratic candidate, and was a communicant of the Roman Catholic church. John P. Coar was born in Scranton, and there died August 7, 1907, aged forty-two years. He was educated in the public schools of the place of his birth, and in later life was a merchant and hotel proprietor. He married Hannah (O'Connor) Reedy, widow of John Reedy, and had two sons, Matthew A., of whom further, and Stanley F. By her first marriage Hannah O'Connor was the mother of: David J., ex-district attorney of Lackawanna county; Walter M., a physician; John J.; William; Mary E., married M. J. Walsh.

Matthew A. Coar, son of John P. and Hannah (O'Connor-Reedy) Coar, was born in Scranton, Lackawanna county, Pennsylvania, September 20, 1888. He was educated in his native city, his scholastic training including a course in the Scranton Technical High School. After a two-year course in the University of Pennsylvania, Mr. Coar was for six months employed by a commercial paper and a bonding house of Philadelphia. He then returned to Scranton, and in the fall of 1911 opened an office in the Miller Building and began business as M. A. Coar & Company. Stocks and bonds are his line, and since April 1, 1914, he has been located in the Mears Building, where he has extended his operations until his business has attained generous dimensions. Mr. Coar is a member of the younger fraternity of Scranton business men, and has successfully entered upon a career of much promise, his reliability and uprightness being important factors in the confidence he has earned among his numerous clients. Mr. Coar is a member of the Benevolent and Protective Order of Elks, a Democrat in politics, and belongs to the Roman Catholic church.

---

### JOSEPH H. JONES

The establishment on the corner of Adams avenue and Linden street, the pharmacy of Joseph H. Jones, is one of the most generously patronized of the city, and is conducted by a gentleman who is no less favorably regarded in the business fraternity of the city than his store among others catering to the same needs of the people. Mr. Jones, American by birth, is of English descent, England having been the land of his fathers, Leicestershire, in that country, having been the place of birth of his father, John Boals Jones, born September 13, 1821.

John Boals Jones made his home with foster parents, in his youth attending the schools of the shire, whence he was graduated at the age of sixteen years, soon afterward coming to the United States. In this country he was legally adopted by his grandfather, who took him into a business partnership, after which he moved to Wilkes-Barre, Pennsylvania, and engaged in mercantile dealings with W. J. Landmesser, remaining in this place for twelve years. He then received an appointment as superintendent of the Delaware and Hudson Coal Company at Carbondale, his superior in office being Edward Weston, and this office he held until his death from an attack of pneumonia in 1870. He married Elizabeth L., daughter of Philip J. Myers, of Slocum, Luzerne county, Pennsylvania. Philip J. Myers, of German descent, was born in eastern Pennsylvania, and purchased one square mile of land in Luzerne county, upon which has grown up the town of Slocum, a place of about one thousand inhabitants. Children of John Boals and Elizabeth L. (Myers) Jones: 1. William Lewis, a

resident of Buffalo; married and has a son, Franklin, who is associated with the New York Telephone Company, of Albany, New York. 2. Esther S., married E. J. Shepherd, a member of the firm of Matthews Brothers, and has one daughter, Mabel, their son, Frank, deceased. 3. Elmer B., an employee of the Delaware, Lackawanna & Western Railroad; married a Miss Ogden; children: Calendar, George, Harry, Esther, deceased. 4. George S., a druggist of Scranton. 5. Joseph H., of whom further. 6. M. Elizabeth.

Joseph H. Jones, son of John Boals and Elizabeth L. (Myers) Jones, was born in Carbondale, Lackawanna county, Pennsylvania, and obtained his educational training in the public schools. He came to Scranton in 1882 and received his first business experience as a newsboy, later entering the service of the Delaware, Lackawanna & Western Railroad Company. In 1884 he left railroad service, having been convinced that if there were opportunity in such a line his entrance had not been made in the department in which room for advancement was to be found. He was employed in the drug store of Matthews Brothers on Lackawanna avenue, in that year beginning as association that continued for more than twenty years, during which time he came to be known as one of the most popular and obliging members of the sales force of this concern, his courteous and gentlemanly manners making business contact with him a pleasure. Retiring from the service of Matthews Brothers, Mr. Jones abandoned business for two years and took a much needed rest, in 1907 purchasing the drug store on the corner of Adams avenue and Linden street that had formerly been conducted by Frank Beavers, the establishment opening under its new ownership on May 27, of that year. In the seven years that have passed since the business came under the control of Mr. Jones vast improvements and long forward strides have taken place in its condition, the qualities that made Mr. Jones valuable as an employee now bringing their returns to him as the proprietor of this establishment, which ranks among the leading pharmacies of the city. It is thoroughly and excellently equipped, has at its head a gentleman of knowledge and experience in his line, and is a worthy institution in a city boasting many such. Mr. Jones is a member of the Scranton Board of Trade, and holds place on the directory of the Anthracite Trust Company, this latter being his only business connection outside of the ownership of his pharmacy. Mr. Jones is a holder of much valuable real estate.

Mr. Jones married (first) June 18, 1894, Madie J. Ellis, of New Berlin, New York, who died in 1901. He married (second) Anna, daughter of George N. Myers, of Slocum, Luzerne county, Pennsylvania. Her father was an agriculturist and stock raiser, and a director of the People's Bank, of Wilkes-Barre.

---

#### PATRICK JOSEPH CASEY

Long life and prosperity are attending handmaidens of those fortunate enough to be born Casey. In Scranton the name is well known in financial and business circles, while towering high above its surroundings is the Hotel Casey, a monument to the enterprise and public spirit of the Casey Brothers, Patrick J. and Andrew J., also one of the most noted of Pennsylvania hotels.

Timothy Casey, grandfather of Patrick J. Casey, died in Ireland, his lifetime home, aged one hundred years. He left issue: Patrick, John, Lawrence, James T., Mary and Winifred. The line of descent is through James T.

James T. Casey was born in county Sligo, Ireland, died January 10, 1907, aged eighty-five years. He married Catherine Giblin, who died March 1, 1903, aged seventy-nine years. Children: Lawrence, Timothy, Andrew Jo-





*P. J. Casey*







A. J. Casey.

seph, James J., Catherine, (who is Mrs. James J. Fleming, of 337 Jefferson avenue, Scranton, Pennsylvania), Mary, (now Mother Edan, Convent of Mercy, Ballymote, county Sligo, Ireland), Bridget, (who was Mrs. B. Mulligan, died at Scranton, Pennsylvania, October 20, 1909), Wimifred, (who is Mrs. B. Candon, identified with a large export business at Ballaghadereen, county Roscommon, Ireland), Patrick Joseph.

Patrick Joseph Casey was born in county Sligo, Ireland, March 11, 1868. He attended the public schools until 1883, then accompanied his father to the United States, arriving at New York, on the steamship "Urania," on May 30th of that year. His father had made several trips previously and his elder brothers, Lawrence, Timothy, Andrew J. and James J., were established in business in Scranton. After his arrival Patrick J. was employed as office boy by his brothers, advanced rapidly, and on attaining suitable age was admitted to a partnership, the firm trading as Casey Brothers, wholesale liquors, importers, distillers and rectifiers, 214-216 Lackawanna avenue. In 1907 the surviving members, A. J. Casey and P. J. Casey, became an incorporated company, Andrew J. Casey, president, Patrick J. Casey, secretary and treasurer. The firm is a leading one in their line and transacts a large business in all departments. In 1910 they erected the Hotel Casey at a cost of \$1,000,000. The hotel was formally opened, January 21, 1911, by a banquet attended by a large number of invited guests, and was an event long to be remembered. Large and commodious as is this important addition to the hotel enterprises of Pennsylvania, it has proved inadequate to meet the demands of the traveling public in point of size, and will be enlarged during the coming year. In addition to his large interests in Casey Brothers, Patrick J. Casey is president of the Liberty Discount and Savings Bank of Carbondale, Pennsylvania, and manager and director of the Pennsylvania Central Brewing Company. Mr. Casey is a member of the Scranton Club, the Benevolent and Protective Order of Elks, the Royal Arcanum, and the Improved Order of Heptasophs. He is a Democrat in politics, and a member of the congregation of St. Peter's Cathedral (Roman Catholic).

Mr. Casey married Bridget Angela, daughter of O. T. O'Malley, and sister of Rev. D. J. O'Malley, pastor at Honesdale for many years until his death in 1891. O. T. O'Malley was a lifelong resident of Scranton, and a trusted employee of the Delaware, Lackawanna & Western Railroad Company until his death in 1890. Children of Patrick J. and Bridget A. (O'Malley) Casey: Joseph, Eugene, Cyril, Jerome, Aloysius, Lawrence, Adrian, Marian, Angela. The family residence is at No. 330 Clay avenue.

---

#### ANDREW JOSEPH CASEY

Andrew Joseph Casey was born in county Sligo, Ireland, April 25, 1856. He received his education in schools in the vicinity of his birthplace, and at the age of fourteen years emigrated to America, arriving here, June 29, 1872. His elder brothers, Lawrence and Timothy, were already located in Scranton, Pennsylvania, and he joined them there. He found employment in the Cliff Works, running a drill press for the Dickson Manufacturing Company, remaining with this concern one and a half years. He then became associated with his elder brothers, who were conducting a wholesale liquor business on Penn avenue, and after the death of both he took charge of the business alone. After a short time, in 1887, he associated with himself his younger brother, Patrick Joseph, and continued the business a further two years on Penn avenue. He then removed to No. 220 Lackawanna avenue, removing to No. 218 on the same street at the end of three years, and, having improved Nos. 214-216, and

altered them to suit the scope of his business, moved into these quarters at the end of another eighteen months, and is conducting an exclusively wholesale business there at the present time. He is also one of the proprietors of the Hotel Casey, one of the finest hotels in this section of the country. It contains two hundred and fifty bedrooms, and at the present time one hundred more are being added. It is conducted along the most modern and up-to-date style, the service and cuisine are unexceptionable, and it enjoys a well deserved popularity. As a financier Mr. Casey has also shown marked ability and is the treasurer of the Pennsylvania Central Brewing Company; president of the Merchants' and Mechanics' Bank of Scranton; and a stockholder in several other institutions of equal importance. He resides in a palatial mansion at No. 612 Clay avenue, which is furnished in the most sumptuous and luxurious manner. He is a life member of the Benevolent and Protective Order of Elks, the Holy Name Society and the Catholic Club. Mr. Casey married Mary O'Brien, of New York, who died February 22, 1904. They have had children: Pauline, born April 29, 1899; Andrew Joseph Jr., born February 17, 1904.

#### HOMER NICHOLSON

Wayne county, Pennsylvania, was the early home of the family of Nicholson in Pennsylvania, that having been the place of residence of Fitch Nicholson, grandfather of Homer Nicholson, treasurer of the American Brick Company, of Scranton.

(I) Fitch Nicholson was a follower of the carpenter's trade. He married Lucia Saunders and had children: Addison A., of whom further; Homer, a cabinetmaker, enlisted in the Union army in the Civil War and served throughout the greater part of that struggle, his death caused by fever and occurring in the field hospital; Mahlon, a cabinetmaker.

(II) Addison A. Nicholson, son of Fitch and Lucia (Saunders) Nicholson, was born in Wayne county, Pennsylvania, in August, 1848. He is a carpenter by trade and has conducted building operations for the greater part of his life, being also one of the first oil prospectors to operate at Oil City, Pennsylvania. During the last eleven months of the Civil War he was a soldier in the Union army. He married Matilda, daughter of Lee Phillips. The father of Lee Phillips was early a resident of the Scranton district, and was the owner of two hundred acres of land now occupied by the city. Children of Addison A. and Matilda (Phillips) Nicholson: Malvina, deceased; Homer, of whom further; Carrie, unmarried; Lee, a farmer, married Martha Harrison; Edna, a graduate of the Bloomsburg Normal School.

(III) Homer Nicholson, son of Addison A. and Matilda (Phillips) Nicholson, was born in Harveyville, Pennsylvania, June 9, 1871. After a course in the public schools of his native county, Luzerne, he became a student in the Huntingdon Mills Academy. His education completed, in December, 1893, he became associated with the Prudential Life Insurance Company of America in Scranton, afterward accepting a position as manager of agents for northeastern Pennsylvania with the Bankers' Life Insurance Company, of New York City. Mr. Nicholson subsequently became treasurer of the Salem Hill Company, an office he filled for five years, then assumed the duties of the treasurership of the American Brick Company, his present position. His handling of the finances of the two last-named companies has been marked by competent management and unfailing ability, the scrupulous care with which he discharges these duties with the American Brick Company claiming and receiving the appreciation of those associated with him in the direction of the business. Aside from his connection with the American Brick Company, Mr.

Nicholson is interested in the manufacture of culm into bricquettes. He has been for seventeen years a member of James Connell Lodge, Independent Order of Odd Fellows, in which he has held high official position, and belongs to the Elm Park Methodist Episcopal Church. His political party is the Republican. He married Susie, daughter of Rufus Burritt, and has children: Myrtle Edna, Matilda, Rufus, Hazel, Homer, Walter.

---

#### FREDERICK VICTOR HARTZELL

A leader in his line of business, prominent in social and fraternal circles, and well known in the district in which he lives, Frederick Victor Hartzell is distinctively a Pennsylvanian, all of his family having resided in this state since the establishment of the line in America.

Hendrick Hartzell, a native of Switzerland, in 1732 left his homeland and came to America, making his home in the province of Pennsylvania, near Philadelphia. His son, Jonas, was born in 1744, and from him the descent to Frederick Victor is through Solomon, Reuben, and Edward. The spelling of the name, originally Hertzell, was changed by Solomon to Hartzell, which latter form has been used by all succeeding generations. Edward, son of Reuben Hartzell, was born at Wind Gap, Northampton county, Pennsylvania, in 1850, died June 8, 1910. His trade was that of machinist and in this capacity he was employed by the Delaware and Hudson Canal Company for a period of thirty-five years, during which time he became one of the most trusted of the company's employees, on all occasions impressing those above him in office with his fidelity and dependability. He married Louisa Maire, of French descent. They were the parents of: 1. Frederick Victor, of whom further. 2. Daniel Edward, foreman in the shops of the Delaware and Hudson Company. 3. Leona, married A. Ridgeway, and resides in Scranton. 4. Louisa, twin of Leona, married William Clegg, of Green Ridge, Pennsylvania.

Frederick Victor Hartzell, son of Edward and Louisa (Maire) Hartzell, was born in Scranton, Lackawanna county, Pennsylvania, February 21, 1874. He obtained his general education in the public schools, finishing his studies with a practical course at Wood's Business College, whence he was graduated in 1894. He immediately entered the employ of G. R. Clark, a florist, with whom he remained for two and a half years, then pledging his services to George W. Hornbaker, after five years purchasing Mr. Hornbaker's business. Soon after this transaction he contracted a partnership with Emmett Simons, of Green Ridge, Pennsylvania, the dissolution of this association occurring four and a half years later, Mr. Hartzell receiving the appointment of district deputy of the Modern Woodmen of America. In 1902 Mr. Hartzell accepted a position with J. B. Fish, whose offices were in the Auditorium Building at Providence, Pennsylvania, at about the same time beginning in fire insurance and real estate dealing independently, and at the present time conducts his enterprises with lucrative and pleasing results. He became the owner in 1913 of the Auditorium Building in Providence, a desirable office building and a valuable property. Mr. Hartzell is a stockholder in various financial and industrial institutions in Scranton and the Lackawanna Valley, is regarded as a most able financier and business man, and was made treasurer of the Old Home Week Association. Fraternally he is connected with many lodges and orders, holding membership in the Independent Order of Odd Fellows, being past grand of Celestial Lodge, and of Post Grand Association; the Masonic Order, in which he holds the thirty-second degree; the Patriotic Order Sons of America, being financial secretary of Washington Camp, No. 1770, and a member of the Past Presidents Association; the Independent Order of Forest-

ers; the Modern Woodmen of America, in which he is a clerk of Providence Camp, No. 9155. He is also a member of the Underwriters Association, and is one of the members of the advisory committee of the Young Women's Christian Association. The Methodist Episcopal is the faith of which he is a communicant, and he is steward of the organization of that denomination at Providence. Mr. Hartzell's political allegiance has ever been accorded the Republican party, and in 1914 he was the candidate of that party for the state legislature from the second legislative district.

Mr. Hartzell married, November 15, 1898, Alice M., daughter of William and Mary (Meredith) Guest, and has children: Helen L., Edward F., Ruth R., William Edward, and Ruth. He and his two sons are the only living male descendants of Solomon Hartzell, his great-grandfather. The family home is at No. 439 East Market street, Green Ridge, Pennsylvania.

---

#### HENRY WILLIAM MULHOLLAND

That the farm has furnished the city and nations with many of its best citizens and greatest men in business, professional and military life, is a fact no one controverts. The reason may be harder to find, but the fact that country life throws a lad upon his own resources, which develops confidence and self reliance, is one cause. The progenitors of Mr. Mulholland were farmers in Ireland, Canada and Pennsylvania; men of strong body and keen minds developed under conditions that try the soul but make the man.

His father, Bernard Mulholland, was born in county Down, Ireland, January 28, 1834. In the spring of the same year, the family left their native land, settling near Brockville on the St. Lawrence river, in Canada, where the family lived on a farm until 1849, at which time they moved to Archbald, Pennsylvania, thence in 1865 to Jermyn, thence in 1884 to the farm in Scott township, Lackawanna county, which Bernard Mulholland owns and on which he yet resides. He married Ann Gardner, born in county Mayo, Ireland; children, all living: Henry William, of whom further; Catherine, married C. E. Taylor; John B., a farmer of Lackawanna county; Ellen, a school teacher; Edward J.; Susan; Nora; Rosanna; Thomas J.; Margaret, married R. H. Kervin; Martin D.

Henry William Mulholland, son of Bernard and Ann (Gardner) Mulholland, was born in Archbald, Pennsylvania, September 8, 1859. He obtained his education in the public schools of Jermyn. Deciding upon the legal profession he studied under the preceptorship of D. W. Connoly, of Scranton, 1879-82, and in the spring of the latter year was admitted to the Lackawanna county bar. He began practice shortly afterward and in due course has been admitted to all state and federal courts of the district. He has practiced continuously in Scranton for thirty years and is one of the strong men of the Lackawanna bar. He is a member of the bar associations of county and state, and holds the esteem of his professional brethren to a high degree. His practice has kept pace with his growing powers of mind and learning and is of generous proportions. In political faith he is a Democrat.

---

#### PETER FOLEY LALLEY

For ten years an established pharmacist of the city of Scranton and for several years prior to that time connected with the drug business of this city and Rendham, Pennsylvania, Peter F. Lalley holds a position in his profession worthy of a longer record of service and eloquently testifying to his merit and worth.



He is of Irish descent, his grandfather, Patrick Lalley, having been a native of county Mayo, Ireland, a land owner and farmer of Dereveney, where he passed his entire life. He was twice married, having by his first wife one son, Michael, and by his second, Martin, Thomas, Mary, Nora. Michael Lalley, father of Peter Foley Lalley, was born at Dereveney, county Mayo, Ireland, July 4, 1838, and in that country lived until his sixteenth year, at which early age he went to England, later enlisting as a private in the English army. Most of his service was in China, and while in the army he passed through many experiences that were in themselves a liberal education, and provided him with a fund of knowledge and reminiscence that in later years made him an exceedingly interesting conversationalist and raconteur. In 1867 he moved to the United States and settled at Rendham, Pennsylvania, where he engaged in different branches of mining until his death, which occurred April 10, 1906. He married Catherine Foley, and had one daughter, Mary F., and one son Peter Foley, of whom further.

Peter Foley Lalley, only son of Michael and Catherine (Foley) Lalley, was born at Rendham, Pennsylvania, March 11, 1870, and until he was nineteen years of age continuously attended the public schools of Old Forge, Pennsylvania, with the exception of a short time spent in the breaker of a nearby mine. At that age he obtained his first experience in the business in which he is now engaged in the drug store of his uncle, James Foley, proprietor of a pharmacy in Rendham. In 1889 he moved to Scranton and entered the drug store of D. S. Ryan, of Hyde Park, his employer for three months, after which he became employed by Dr. J. A. Manley, proprietor of a drug store now owned and conducted by Andrew Brown. Mr. Lalley, in August, 1892, went to New York City and entered the College of Pharmacy now connected with the University of Columbia, and after a two-years' course was graduated in 1894. He immediately took the examination before the State Pharmaceutical Examining Board and at that time took examination in New York state and successfully passed both examinations and registered under the laws of Pennsylvania and New York states. After receiving his diploma he returned to Rendham and once more entered the drug store of his uncle, after eighteen months purchasing the establishment from its original owner. For the ten following years he conducted the store, for the same length of time holding the office of postmaster of Rendham, and on December 23, 1904, moved to Scranton. Purchasing the property at No. 328 Pittston avenue, he there installed all the equipment of a modern drug store which he has since improved from time to time and now conducts a pharmacy complete in appointment, excellent in reputation, and generously patronized.

An exponent of a delicate profession, one in which the slightest trace of carelessness may spell disaster to some unfortunate, he has so conducted his large business that he holds the confidence of many of the city's physicians who feel that in placing a prescription in his hands they are assured of the watchful care and vigilant caution that the profession demands. His prescription files contain papers given by the most eminent lights of the medical profession in Scranton, and his reputation as a gentleman of honor, one who observes strictly the legal regulations justly imposed upon his business, is known to all. Mr. Lalley is a Democrat, and holds membership in the Knights of Columbus, Sons of St. George, and the Ancient Order of Hibernians.

---

#### JOSEPH FREY GILROY

Although a successful practicing attorney of the Lackawanna county bar, Mr. Gilroy is a native born son of Lycoming county, Pennsylvania, and there

spent his early life. He was born in Williamsport, November 3, 1872, the second son of John G. and Frances Seybert Gilroy. After passing through the public school of his native city, he entered Dickinson College, at Carlisle, Pennsylvania, there completing his classical education, graduating with the class of 1895. He studied law under Henry C. McCormick, of Williamsport, and graduated from the Dickinson Law School, at Carlisle, in 1896; was admitted to the bar of Cumberland county in June, 1896. He entered upon the practice of his profession at Scranton, in September, 1896, having been admitted to the Lackawanna county bar. He has been in active practice of the law at Scranton since that time.

Mr. Gilroy married, September 4, 1902, Virginia T. McIntyre, of Carlisle, and has two children, Elliott Kisner and Eleanor McIntyre. Mr. Gilroy is interested in commercial pursuits and is a director of the Peck Lumber Manufacturing Company, and a director of the First National Bank, of Jessup, Pennsylvania. He resides on Main street, Peckville.

---

#### EDWARD HERBERT DAVIS

The record of this ancient New England family is related to the city of Scranton through Edward Herbert Davis, an architect of the city, who has made Scranton the scene for the practice of his profession and has risen therein to a leading position, his practice firmly founded upon architectural achievements of unusual order. The line of Davis, a Massachusetts family resident in Barnstable, was moved to Gorham, Maine, at about the beginning of the Revolutionary War by Josiah Davis. His son, Silvanus, married Hannah Gorham, a member of the family from whom the afore-mentioned town took its name, and had a son, Abner, born in Buxton, Maine, in March, 1811. Abner Davis was a flour merchant and shipper, a Republican in politics, and a member of the Congregational Church. He was twice married (first) about 1836, to Dorothy Abbott. By his first marriage he was the father of Edward Hotchkiss, of whom further, and Emilie D., born at Stow, Maine, in 1840. The children of his second marriage were: Marshall Wheelock, principal of the Roxbury Latin School at Boston, Massachusetts, and Catherine, married William Skillings, deceased, lumber merchant of Boston.

Edward Hotchkiss Davis, son of Abner and Dorothy (Abbott) Davis, was born in Brownfield, Maine, in 1839. For several years he was connected with the treasury department at Washington, D. C., as deputy sixth auditor, and was also collector of the port of Portland. His political party was the Republican. He married, January 14, 1865, Francena Helen Freeman, born in Windham, Maine, April 14, 1840, daughter of Benjamin, born in Windham, Maine, October 8, 1818, and Martha Anne (Ingersoll) Freeman, born in the same place in 1823. Benjamin was a son of Josiah and Betsy (Webb) Freeman. Edward Hotchkiss and Francena Helen Davis were the parents of one son, Edward Herbert, of whom further.

Edward Herbert Davis, son of Edward Hotchkiss and Francena Helen (Freeman) Davis, was born in Washington, D. C., February 14, 1867, and after attending the high school of that city obtained his professional education in the Washington School of Arts in the same city. His studies completed he passed three years in gaining practical professional experience in the offices of C. A. Didden, Harvey L. Page, and Hornblower and Marshall, of Washington, and for the four following years was associated with M. B. Haupt, of Wilkes-Barre, Pennsylvania. Then fully fitted to cope with the most difficult problems of his profession in competition with the most able, on June 23, 1892, he opened an office in Scranton, speedily gaining prestige in

the fraternity of architects until at the present time he holds a prominent place among the foremost of his profession. A Republican in politics, the desire for office has never been felt by Mr. Davis, and it has been as a private citizen that he has supported his party. He is a stockholder in several financial and industrial institutions in the locality, and affiliates with the Masonic order, belonging to Lodge, Chapter, Commandery, and Shrine. His club is the Scranton, and he holds membership in the Church of the Good Shepherd (Episcopal).

He married, in St. Stephen's Church, Wilkes-Barre, Pennsylvania, June 21, 1888, Regina Amanda, born in Wilkes-Barre, Pennsylvania, June 23, 1867, daughter of Byron and Alice M. Shoemaker. Byron and Alice M. Shoemaker had children: Regina A., of previous mention, married Edward H. Davis; George M., Ethel E., Byron C., William V., and Alice C. Mr. and Mrs. Davis had one son, Edward H. Jr., born August 10, 1891, died October 31, 1898.

---

### JOSEPH J. CURT JR.

The Curt family is of English lineage and traces back many generations in which a son bore the name Joseph, the family in Scranton, father and son, bearing that name as did the two preceding generations here mentioned.

Joseph Curt, great-grandfather of Joseph J. Curt, of Scranton, was an accomplished linguist and skillful musician, brought through these gifts to a close personal friendship with the then ruling monarch, King Emanuel of Italy. His son, Joseph (2) Curt, was manager of the large, fashionable and exclusive catering establishment, Joseph Gunter & Sons, of London, England. Joseph J. Curt, son of Joseph (2) Curt, was born in London, England, in 1853. He married, in 1877, Annie M., daughter of Joseph Smith, a veterinary surgeon of Framlingham, England, and in the same year came to the United States. He was employed for several years in a company store of Jermyn, Pennsylvania, and is now a resident of Scranton, engaged as foreman. Children: Joseph J., of whom further, and Howard, deceased.

Joseph J. (2) Curt, son of Joseph J. (1) and Annie M. (Smith) Curt, was born in Jermyn, Pennsylvania, August 25, 1880. He obtained his education in the public schools of Scranton, and attending school No. 33, and School of Lackawanna, beginning business life in 1897 as supply clerk for the Marion Coal Company, of Pottsville, Pennsylvania, his father being at that time outside superintendent of that company. In 1899, the father having been placed in charge of the Delaware, Lackawanna & Western mine at Taylor, Pennsylvania, the son moved to that place and was appointed supply clerk at the mine, serving as such for two years, then was promoted office clerk and later assistant foreman of the Taylor Mine. He was then selected to oversee the construction of the Taylor Washery, a plant completed and placed in operation during the great coal strike of 1902. He was foreman of the plant after its being placed in commission and was then the youngest foreman in the employ of his company. In 1906, despairing of further advancement, he resigned his position with the Delaware, Lackawanna & Western and formed a partnership with Harry Rheinhart, purchasing a sporting store of George Schlaeger on Washington avenue, Scranton, and nine months later he sold out to his partner and bought an interest in the firm of Robinson & Adams, sporting goods dealers, succeeding Mr. Robinson in the firm. It was at this time that Mr. Curt became identified with the auto business and sold the first Maxwell automobiles in 1906 and 1907. In 1908 he sold out to his partner, Mr. Adams, to accept the management of the Scranton Garage & Motor Car Company, then the largest con-

cern of its kind in the city. This firm was agent for the "Franklin" and "Buick" cars, Mr. Curt continuing until the firm sold out to the Scranton Automobile Company in September, 1908, and with the latter firm until the spring of 1909, when he entered the employ of Edward Conrad, as salesman. In September, 1909, Mr. Curt organized the Anthracite Motor Car Company, with F. A. Clark. They began business as agents for the "Overland" and "Corbin" cars, their garage located at No. 625 Lackawanna avenue. Within a year they found their floor space entirely too small to accommodate their growing business, which fact caused them to take on the adjoining store which was soon remodeled as to form an important addition to their plant. In January, 1913, Mr. Curt purchased the interest of Mr. Clark, and is now sole owner of a very prosperous business. He is agent for the Overland and Willys Utility Truck, the Chase Truck and has a good garage and repair trade. Since November, 1909, he has sold two hundred and twenty-five autos and trucks, and his repair department only receives cars of the make for which he is agent. This feature is unusual, but to the fact that he only sells one car and one truck and devotes his entire repair department to these cars, Mr. Curt attributes his success. He is very fond of out-door life, and is an enthusiastic automobilist. He is a member of the Automobile Association of Scranton, the United Sportsmen of Pennsylvania, the Scranton Rod and Gun Club and the Rotary Club. He is a member of the Protestant Episcopal Church, his mother and her ancestors having been members of the Established Church of England for four centuries. He is a Republican in politics, and while living at Taylor served as councilman, being elected by a plurality of one vote.

Mr. Curt married Edith Allen, daughter of Dr. J. W. and Sophia (Mahoney) Houser, of Taylor, Pennsylvania. Child, Christine Houser, born April 14, 1913.

---

### JOHN ZEIDLER

The foreign-born citizens of this country have ever been noted for the patriotic spirit they display and for the interest they manifest in the development of the communities in which they locate, and these characteristics were fully marked in the case of the Zeidler family, and especially so in the case of the late John Zeidler, who for many years was an honored and respected resident of Scranton.

John Zeidler was born in Selb, Bavaria, January 15, 1828. He was reared and educated in his native place, remaining there until he attained the age of eighteen years, when he emigrated to the United States, believing that the opportunities for advancement and progress were greater in the new than the old world. In 1854, after eight years' residence in Haller, he removed to Scranton, Pennsylvania, and there spent the remainder of his days. He established a bakery business at No. 217 Lackawanna avenue, removing later to Franklin avenue, and this proved a most remunerative means of livelihood, he conducting it in a thoroughly business-like manner, using nothing but the best materials, hence his products were the best. He continued the active management of the business up to the time of his decease, the business then passing to the control of his daughter, Miss Maggie Zeidler, who has since proven herself a competent and efficient manager. In addition to this enterprise, Mr. Zeidler conducted what was known as Zeidler's Restaurant, located in the Germania block on Lackawanna avenue, which was erected by Mr. Zeidler, and subsequently he erected the Zeidler or Valley Home block, also on Lackawanna avenue, which at that time was the most extensive block in the city of Scranton. From these he derived a goodly income, they being conducted along



*John Heidler*



practical lines. Mr. Zeidler went as endorser on many notes, and during the panic of 1873, when so many business men failed, he was compelled to honor these notes, consequently he was obliged to lose the property that he had accumulated by years of hard toil and persistent effort. This calamity, which would have discouraged men of less strength and force of character, only served to make him redouble his efforts, and in due course of time he succeeded in accumulating considerable capital and property, being enabled to leave to his family at his death an extensive and valuable estate, a fact which eloquently testified to the character of the man. Mr. Zeidler was an active and earnest member of Zion Lutheran Church, as was also his wife, contributing generously toward its support and maintenance. He was hospitable, charitable, generous, with a ready sympathy for these in affliction or need.

Mr. Zeidler married, in 1857, at Pittston, Pennsylvania, Mary Bechtold, a native of Hesse-Darmstadt, Germany, her birth occurring in 1834, and in 1848, at the age of fourteen years, she accompanied her parents to this country, they locating in Pittston, Pennsylvania, where they spent the remainder of their days. Mr. and Mrs. Zeidler were the parents of six children, namely: Mrs. Rudolph Bloeser, Mrs. F. G. Diem, John L. Zeidler, Miss Maggie Zeidler, Mrs. Louis Linder, and Mrs. Harry S. Poust.

Mr. Zeidler passed away at his home in Scranton, January 23, 1892, and his widow passed away September 15, 1897. Their funeral services were conducted in Zion Lutheran Church, being attended by representative gatherings, and the interments were in Washington Avenue Cemetery. The pastor of the church, Rev. P. H. Zizelmann, delivered an eloquent tribute to the many excellent characteristics displayed in the life of Mrs. Zeidler, who was an active factor in the work of the various societies connected with the church for many years.

---

#### THOMAS MORTIMER VOYLE

Of an old Olyphant, Lackawanna county family, Mr. Voyle descends from a family of successful merchants. His grandfather, Thomas Voyle, was a highly respected merchant of Carbondale and Olyphant, and was succeeded in business by his son, David M. Voyle, who became owner of the Olyphant store. Thomas Voyle served several terms as mayor of Carbondale, and was a man of influence and high standing, both in the business world and in official life. He married Anna Davenport and had issue: Frances, Louise, Ella, Anna, Uriah, David M.

(II) David M. Voyle, father of Thomas M. Voyle, inherited his father's mercantile ability, and during the lifetime of the latter was his business associate, later his successor. He married Jane, daughter of John Price. Children: Anna, Cora, Thomas Mortimer, Gertrude, David, Jennie.

(III) Thomas Mortimer Voyle was born at Olyphant, Lackawanna county, Pennsylvania, August 13, 1872. He was educated in the public schools of Olyphant, which he attended until 1889, then was a student for one year in a private school in Scranton. He then became associated with the Scranton Supply and Machine Company, continuing until August 1, 1906, when he was promoted to the position of manager to succeed W. S. Boyd, deceased. He still fills this important position, his company being the leading mill and mine supply house of Northeastern Pennsylvania. Mr. Voyle is prominent in the Masonic Order, belonging to Keystone Lodge, Free and Accepted Masons; Lackawanna Chapter, Royal Arch Masons; Coeur de Lion Commandery, Knights Templar; Irem Temple, Ancient Arabic Order Nobles of the Mystic

Shrine. He is a member of St. Luke's Protestant Episcopal Church, Engineers' Society of Northeastern Pennsylvania, and the Scranton Club.

Mr. Voyle married, October 8, 1908, Grace E. Lawrence, daughter of Philip Lawrence, of Philadelphia, Pennsylvania. Children: Two daughters, Jane L. and Grace T. The family residence is at No. 317 Wheeler avenue, Scranton.

---

### FLETCHER C. STACKHOUSE

Inheriting the adventurous blood of his pioneer grandfather and his honored father, who gave up his life on the field of battle, Mr. Stackhouse saw life in its many phases in many states of the Union before coming to Scranton where he is rated one of the capable business men of the city. He is a grandson of Joseph Stackhouse, of New Jersey, who early came to Shickshinny, Luzerne county, Pennsylvania, where he acquired large holdings of timber land, owned two saw mills and became an extensive lumber dealer.

(II) Jesse B. Stackhouse, son of Joseph Stackhouse, was born in New Jersey and came with his parents to Luzerne county, Pennsylvania, at an early day. He became a foundryman, his plants being devoted to the manufacture of cook stoves and plows. Early in the conflicts between the states, he enlisted in the Forty-third Regiment Pennsylvania Volunteer Infantry and met his death at the battle of Hatcher's Run. He married Margaret Hazlett.

(III) Fletcher C. Stackhouse, son of Jesse B. and Margaret (Hazlett) Stackhouse, was born at Shickshinny, Luzerne county, Pennsylvania, October 11, 1856. He was educated in the Hartford School for Soldiers' Orphans, remaining there until he was fifteen years of age, then returned home, finishing his studies at the school of his native town, taking a business course. He then spent several years in the states of Iowa, Illinois, Missouri, Kansas and New Mexico (then a territory), mostly being employed in railroad offices. He remained in the West until 1883 when he returned to his home town in Pennsylvania. He spent two years there in business for himself, coming to Scranton in 1885. He entered the employ of the Hunt & Connell Company as bookkeeper, continuing with them twelve years. In 1897 he came with the Scranton Button Company in the same capacity, and thirteen years later, in 1910, was elected secretary of the company, a position he yet efficiently fills. His experience in the business world, obtained in many states, is a particularly valuable one, and not bound by tradition or precedent he adopts progressive methods and in so doing has kept his department abreast of the modern methods that prevail in the other departments of the company's business.

Mr. Stackhouse married, in Sterling, Kansas, Laura A., daughter of David Seltzer, of that city. Children: Grace Bell, married Joseph E. Elliot Jr.; Elizabeth, married James H. Neele; Helen; David Keith. The family are members of Elm Park Methodist Episcopal Church.

---

### CHRISTIAN SCHILLINGER

A German by birth, and now holding a position in the industrial world of Scranton, Christian Schillinger's residence in the United States is through the course of fortune rather than because of any plans for which he is responsible. Had he remained in the homeland until he had attained mature years it is highly probable that the ambition and desire for improvement that led his father, Christian Schillinger, to immigrate to this country, would have impelled him to seek an American home, but the need of such a decision was



spared him, and he grew to manhood in the place that has since known his activities.

His father, Christian Schillinger, was born in Emmendingen, Baden, Germany, and was there reared and educated. He was the owner of land and there he conducted farming and fruit-growing operations, later adding lumber dealing to his business and so continuing until his immigration in May, 1893. He was accompanied to this country by his entire family, and settled in Scranton, being employed as teamster at the Hampton Colliery until his death in September, 1901, aged about fifty years. A Republican sympathizer, he belonged to the German Presbyterian Church, and for several years was a member of the official board of that organization. He is buried in the Washburn Cemetery, Scranton. Christian Schillinger married Barbara Woehrle, born in Hornberg Black Forest, Germany, daughter of Conrad Woehrle, a native of the same place, a farmer. Children of Christian and Barbara (Woehrle) Schillinger: Christian, of whom further; Otto, Fred, Anna.

Christian (2) Schillinger, son of Christian (1) and Barbara (Woehrle) Schillinger, was born in Baden, Germany, September 10, 1876. His general education completed in his native land, he passed two years in a technical school, and then served a like time as apprentice in a mechanical art. After accompanying his parents to the United States he took courses in English and mechanical engineering in the International Correspondence Schools, and then obtained a position in the Hampton Colliery of the Delaware, Lackawanna & Western Railroad Company. He passed through various grades of service to the position of coal inspector, then to that of gang foreman in construction, foreman of the boiler and power plant, and finally to his present important place, superintendent of the boiler and power plants of the coal department of the road. Capability and efficiency mark his execution of the duties of his position, and his incumbency thereof has been a satisfaction to his employers and a pleasure to those associated with him. While associated with the Delaware, Lackawanna & Western Railroad Company, Mr. Schillinger was active in the formation of the Schillinger Brothers Company, dealers in tile, of which prosperous concern he is president. Schillinger Brothers Company handles tile for all purposes, flooring and interior and exterior decoration, and has built up a flourishing trade in this line, the material used by them of the best. Not active in political circles, Mr. Schillinger yields allegiance to the Republican party, and is a member of the First German Methodist Episcopal Church. He is a thirty-second degree Mason, and belongs to the Engineers' Society of Northeastern Pennsylvania.

Mr. Schillinger married, October 31, 1900, Ella Henrietta, born in Scranton, daughter of Frank and Albertina Heinen, her parents natives of Germany, residents of Scranton during nearly their entire lives. Mr. and Mrs. Schillinger have one son, Harold Otto, born November 28, 1903, attends school.

---

#### JAMES M. POWELL

Representatives of two generations of the family founded the line of Powell in the United States, Reese C. and Howell Powell, father and grandfather of James M. Powell. James M. Powell, the present day representative of his line in the city of Scranton, whither the two pioneers previously mentioned settled after their immigration to this land, has attained prominence and reputation through his activity in many phases of the city life, political, fraternal, industrial, business, and social. As president and later as secretary of the West Scranton Board of Trade he has been at the head of an organization whose object is the fostering of the city's industries and the establish-

ment of trade conditions that will still further increase the advantages of the locality as an industrial center, while through many other connections he is allied with the strongest forces working for the benefit and credit of the city of his birth.

Howell Powell, grandfather of James M. Powell, was born in Wales, and in 1869 came to the United States, becoming a resident of Scranton. After a few years he returned to his native land, where his death occurred. Reese C. Powell, eldest son of Howell Powell, was born in Wales, died in Scranton, Pennsylvania, in 1907. He came to this city in 1869, his father making the journey with him. He was for fifteen years tax collector for the fifteenth ward of the city, and was long a member of the Welsh Calvinistic Methodist Church, in the work of which he was active. He married, in 1869, Mary James, and had children: Anna, married E. M. Eshleman, of Atlantic City, New Jersey; James M., of whom further; Margaret.

James M. Powell, son of Reese C. and Mary (James) Powell, was born in Scranton, Pennsylvania, January 24, 1875. He was a student in the public schools of his native city until he was a lad of thirteen years, when he entered business life in the employ of R. M. Lindsay, a dry goods merchant of Scranton, remaining in his establishment for three years, then spending half of that time with Joseph A. Mears. The following three years he passed in the service of the Rice, Levy Company, and was connected for a like period with Clarke Brothers, beginning his connection with that firm at the time of its organization. In 1897 Mr. Powell became associated with the Scranton Gas and Water Company, a relation that continues to this time, Mr. Powell having been raised to his present position, that of manager of the gas appliances department, in 1901. His name stands high upon the list of the company's trusted employees, and he directs the work of his department with decisive ability.

Mr. Powell is a member of the West Scranton Board of Trade, and in 1911 was its president, and secretary of the same organization since 1912. His fraternal associations are with Hyde Park Lodge, No. 306, K. of P.; Lackawanna Council, Royal Arcanum, to which he has belonged since 1893, Hyde Park Lodge, No. 339, F. and A. M., having been worshipful master in 1906 and secretary since 1907, and holds the Knights Templar degree, being a member of Coeur de Lion Commandery, No. 17, K. T., in 1912 succeeding the late Edward Buck as recorder. In this order he also holds membership in Irem Temple, Ancient Arabic Order Nobles of the Mystic Shrine. His political party is the Republican, and he was the representative of the fourth ward in select council in 1910 and 1911, in the latter year becoming the candidate of his party for county commissioner.

Mr. Powell married, June 12, 1901, Gwennie M., daughter of William M. and Ann Thomas, of West Scranton, Pennsylvania. William M. Thomas was an engineer in the employ of the Lackawanna Iron and Steel Company, and moved from Catasauqua to Scranton, Pennsylvania, in 1865, his wife still living in the latter city, aged eighty-one years. Children of James M. and Gwennie M. (Thomas) Powell: William, died in 1910, aged eight years; Theodore, born May 3, 1903; Marjorie, died in 1912, aged one year.

---

#### WILLIAM LINCOLN NASH

Entering the service of the Delaware, Lackawanna & Western Railroad Company as a boy of ten years, William Lincoln Nash has remained continuously in that employ until the present time. He has truly served but one master, and if the following recital does not show plainly the fidelity, constancy

and whole-heartedness with which he has done this, then it has failed pitifully in its purpose.

He is a descendant of an English family, his grandfather having come from Bilston, Staffordshire, England, to the United States as a young man, settling in Philadelphia, Pennsylvania. In that city he established in the hardware business, continuing in such dealings until his death. He married Mary Ann Morgan, and had children: 1. Ellen, born October 5, 1821, deceased; married George Stephenson; resided in Scranton. 2. Catherine, born September 16, 1823, deceased; married Ephraim Kellam, who after her death married a second time. 3. John, born July 21, 1825, deceased. 4. Thomas, born December 2, 1827, deceased. 5. Sarah A. M., born January 3, 1830, deceased. 6. Mary, born July 16, 1832; married Nathaniel Gray; resides in Worcester, Massachusetts. 7. Joseph, of whom further. 8. Maria C., born February 11, 1837. 9. Martha, born July 28, 1838; second wife of Ephraim Kellam; lives in Hawley, Pennsylvania. 10. Emelina, born November 16, 1840; married Anson Boles, of Scranton.

Joseph Nash, father of William Lincoln Nash, was born in Philadelphia, Pennsylvania, September 15, 1834, died at Hyde Park, Pennsylvania, July 18, 1898. As a young man he engaged in farming, and when war between the North and South broke out he enlisted in Company A, One Hundred and Thirty-seventh Regiment Pennsylvania Volunteer Infantry, his regiment being immediately forwarded to the front. He had been in the service but a short time when he was stricken with typhoid fever, a malady which so sapped his strength that it was necessary for him to return home to recuperate, although he returned to the army long before his physician considered it advisable. In 1864 he became a member of Company H, Fifty-second Regiment Pennsylvania Volunteer Infantry, and was engaged in all the battles of that regiment until peace was declared. Among the battles in which he took part were Antietam and South Mountain, and he fought in all the other campaigns and battles engaging his regiment. Receiving his honorable discharge from the service, he made his home at Hyde Park, Pennsylvania, engaging in carpentering, a trade he followed during his remaining active years. He married Anna E., daughter of Richard Evans, an undertaker and cabinetmaker. Richard Evans was a native of England, and came to the United States from Liverpool when his daughter, Anna E., was a girl of four years. He went to Wayne county about 1853 and nine years later moved to Scranton, where he was a carpenter until his death. Children of Joseph and Anna E. (Evans) Nash: 1. Helen M. 2. Edith J., married A. B. Mayo. 3. William Lincoln, of whom further. 4. Arthur L., a resident of Scranton. 5. Herbert E., an architect, engaged in business in Albany, Georgia. 6. George E., lives in Scranton. 7. Daisy H., married William Bahr.

William Lincoln Nash was born in Salem, Wayne county, Pennsylvania, August 10, 1864, and until he was ten years of age attended what was then known as the Brick School-house, now School No. 14, of Scranton. At that age he obtained employment in the Hampton Breaker, and from that time until the present day has served the Delaware, Lackawanna & Western Railroad Company, passing through various grades of service, each more responsible and more remunerative than the last, to the position of chief clerk in the auditing department. It would be difficult to give to Mr. Nash too great credit for the advance he has made in the confidence of his employers and superiors in office, confidence that has been expressed by the bestowal of more important duties and in entrusting to his care commissions of importance. At the beginning of his career he was handicapped by a lack of educational advantages. Deprived of the pleasures and benefits of even ordinary school

training he resolutely set himself to the task of overcoming these obstacles and made his work his study, applying himself to this task with such persistence and pertinacity that he was steadily raised to his present important place. None of his fellow employees with whom he has been associated during this time grudge him the advance he has made, though he has left many of them far in the rear, for all recognized the sincerity of his purpose and the earnestness with which he has labored. His friends in the company are many, as are those he has made outside of his business connections, and his genial, hearty and affable nature makes him one under whom it is a pleasure to work and with whom social intercourse is a privilege. Mr. Nash holds membership in Peter Williamson Lodge, No. 323, F. and A. M.; Camp No. 8, S. of V., and is secretary and treasurer of the Memorial Association of the Grand Army of the Republic of this city. He and his family belong to the Elm Park Methodist Episcopal Church, of which they are regular attendants, while politically his actions are guided solely by the occasion and the candidate.

Mr. Nash married Emma, daughter of Martin C. Birtley, of Scranton, and has children: Meltha, born April 12, 1893; Carlton, born March 29, 1898; Ronald, born January 2, 1901; Janet, born June 18, 1907.

---

#### WILLIAM OLIVER JENKINS

During the years from April, 1906, to June 1, 1914, as city assessor, Mr. Jenkins proved his ability as a public official and one who in the discharge of a public duty is upright, fearless and just. A resident of Scranton since 1868, he has passed through many forms of employment peculiar to this section and in mill and mine has proved his right to be considered a man of superior mettle. Descendant of an old Welsh family and himself of Welsh birth he possesses the manly characteristics of that race to which has been added the American, that blend so well with the foreign character. He is a son of Jabez and a grandson of Thomas Jenkins, the latter a life-time resident of Cardiff, Wales, never leaving his native land.

Jabez Jenkins was born in Cardiff, Wales, January 11, 1822, there residing until 1867, when he came to the United States, locating in Baltimore, Maryland, locating a year later in Scranton, Pennsylvania. He married in his native city, Ann Evans, born in Carmarthen, Wales, February 14, 1825. Children: Ann, born February 15, 1846, deceased; Elizabeth, February 15, 1848, deceased; Isabella, December 2, 1850, deceased; John D., August 29, 1852, manager of Schaffer Brothers, Erie, Pennsylvania; William Oliver, of whom further; Elvira, August 16, 1856, deceased; Amelia, July 10, 1863, married Paul Scirefligh, of Scranton; Jabez (2), February 13, 1865, of St. Louis, Missouri; Taliesen, February 16, 1867, deceased. Ann (Evans) Jenkins, the mother of these children, was the daughter of John and Ann Evans, of Carmarthen, later of Cardiff, Wales, where both lived and died. On arriving at Baltimore with his family, Jabez Jenkins secured employment as foreman in a copper smelting plant, but in Scranton engaged as a mechanic. He was a member of the Welsh Baptist Church, and in politics a Prohibitionist.

William Oliver Jenkins was born at Merthyr, South Wales, and for two years attended the public schools. At age of nine years he was working in an iron mill, later went to the coal mines as driver boy. In 1867 he came to the United States with his parents, coming to Scranton in 1868. Here he followed coal mining until 1904, advancing to the position of foreman. In 1901 he was elected a member of the Scranton common council and was re-elected successively until 1906 when he was appointed by Mayor J. B. Dimmick city assessor, an office he held until January 1, 1914. In all his dealings Mr. Jenkins

displayed a keen sense of business honor and gained the confidence of his fellowmen. He is a Republican in politics, member of Scranton Board of Trade, and of the the K. of P., Lodge No. 306, of which he is past chancellor commander. He is deacon and trustee of the Jackson Street Baptist Church, also serving as treasurer and superintendent of the Sunday school. Mr. Jenkins is an active member of the Surface Protection Association of Scranton. This organization's efforts have been instrumental in doing much good towards the protection of life and limb and for the safety and benefit of the city at large.

Mr. Jenkins married, February 9, 1878, at Olyphant, Pennsylvania, Elizabeth Davis, born in Swansea, Wales, January 11, 1852, eldest daughter of William S. and Elizabeth (Jones) Davis. She had brothers and sisters: Benjamin, deceased; Margaret, deceased; Mary; Matilda, married W. O. Adair; William, of Scranton; George, of Scranton. Children of William O. and Elizabeth (Davis) Jenkins: 1. Benjamin, educated in public schools, graduate of Wood's Business College, cashier and accountant for the Armour Packing Company, Washington, D. C.; member of the Masonic Order; he married Anna Davis and has a son William Edward. 2. Cora, a teacher. 3. Alfred Arthur, graduate of Harvard University, 1909, Harvard Law School, 1912, LL. B., now a practicing lawyer of Boston, Massachusetts; member of the Masonic Order. 4. Mabel, a stenographer. 5. Alice Elizabeth, a graduate of Goucher College, 1913, a teacher and assistant principal.

---

#### RUDOLPH M. GOLDSMITH

In 1864 there came to Scranton a young Bavarian, Morris Goldsmith, thirty-one years of age, having been a resident of Pennsylvania twelve years. He was seeking a location for a retail shoe store and decided, in spite of the advice of others, to open his store on the south side of Lackawanna avenue. This would now seem to have been a wise selection, when the five-story building that is necessary to house the business of Goldsmith Brothers, which he founded, is considered, and the solidly built business block covering every lot. But in that day that side of the avenue was vacant, save for a lumber yard, a house that stood on the present site of the Scranton House and perhaps a small shop or two. Lackawanna avenue had plank walks, was unpaved and badly lighted. Mr. Goldsmith's store at the corner of the Alley, directly opposite the present Western Union office, was the first store of any consequence on the south side and an early failure was predicted for the young man by the merchants of the north side of the avenue. But he believed that if he had the goods that the people would come to him regardless of which side of the street he was on. In one year he moved to the present location of Goldsmith Brothers, No. 304 Lackawanna avenue, the oldest shoe business in Scranton, soon to celebrate its semi-centennial. Within four years after it started in business, or in 1868, the south side of the avenue was rapidly building up, and the wise ones, who predicted that business could not be diverted from the north side were taught a lesson by the plucky young foreigner to whom the honor of being the pioneer merchant of Lackawanna avenue south side must ever belong. The business he founded in 1864 was carried on as a retail enterprise for several years, later a wholesale department was added and is so continued. The firm name of Goldsmith Brothers is somewhat misleading, as the founder's only living son, Rudolph M. Goldsmith, is sole owner and proprietor.

Morris Goldsmith was born in Bavaria, Germany, in 1833. In 1852 he came to the United States, making his own way to the coast and there embarking for New York, the voyage being of seventy days' duration. Thence

by stage and canal he reached Honesdale, Pennsylvania, and there opened a shoe store. Two years later he married, and for several years continued in business at Honesdale, then for a short time lived in Wilkes-Barre, later returning to Honesdale and in 1864 came to Scranton. Here he won his way to prominence and wealth by industry, perseverance, thorough acquaintance with the shoe business and a wonderful knowledge of human nature. He was a born leader and in a successful business career of over a half a century demonstrated that public support will always be given a courageous and progressive leader. He won where failure was freely predicted and not only obtained the needed patronage, but set an example that was followed even by business rivals. His judgment was sound; his foresight keen; his integrity unquestioned.

Morris Goldsmith married, in 1854, Regina Friend, of Albany, New York, who preceded him to the grave. He died March 8, 1910, the last survivor of a family of three sons and three daughters, only one of whom remained in Bavaria, the land of their birth. He was survived by his son, Rudolph M., and five daughters: Isabella, married J. R. Cohen; Hannah, married T. A. Stein; Minnie, married Alfred Rice; Pauline, a resident of Scranton; Eva, married Felix T. Levy, of Wilkes-Barre. In addition to these, eleven grandchildren were living at the time of Mr. Goldsmith's death.

Rudolph M. Goldsmith, last surviving son of Morris and Regina (Friend) Goldsmith, was born in Scranton, Pennsylvania, June 4, 1866. The building he now occupies as a store, No. 304 Lackawanna avenue, stands on the site of the then Goldsmith home and is especially dear to him, not only as the scene of his father's wonderful business life, but as his own birth-place, business training school and life-long scene of business activity. He was educated in the city schools and at Easthampton, Massachusetts, leaving the latter school at age of sixteen years. He began business life at that age with his father and has literally grown up with the business of which he is now the honored and capable head and sole owner. This oldest shoe business in Scranton was originally a retail one, but grew into a wholesale and retail one, Rudolph M. having charge of the wholesale department, also acting as traveling salesman until 1890, when he took complete charge of both departments. The entire five stories of No. 304 Lackawanna avenue are devoted to the needs of the business which is a very large and prosperous one, capably managed by the younger man, who has not only maintained its high character, but has so extended and broadened it that Goldsmith Brothers ranks not only among the oldest of Scranton's mercantile houses, but as one of the most reliable and prosperous. Inheriting the virtues and business ability of his honored father, he has improved the additional opportunities afforded him until he takes place among the most progressive and successful men of the city.

Mr. Goldsmith married, 1896, Alice, daughter of Raphael Levy, of San Francisco, California. Children: Morris (2); Madeline; Ralph M.

---

#### KENNETH R. BURNETT

The emigrant ancestor of Kenneth R. Burnett, in the Burnett line is Peter Burnett, his grandfather, who was born in Ireland. He came to Pennsylvania at an early day, settled in Wayne county, Pennsylvania, and there engaged in farming.

(II) Dr. John Burnett, son of Peter Burnett, the founder, was born in Canaan, Wayne county, Pennsylvania, May 13, 1849, died in Scranton, September 30, 1898. He was reared on the farm, obtained a good preparatory education, and prepared for the practice of medicine at the College of Physicians



*J. Burnett*





and Surgeons, New York City, now the medical department of Columbia University, whence he was graduated M. D., March 1, 1876. He began practice at Carbondale, Pennsylvania, March 10, 1876, and continued there in successful and lucrative professional work until 1884, when he disposed of his practice. He then spent six months at the Post-Graduate School of Medicine and Surgery, of Bellevue Hospital, after which he located in Scranton, April 1, 1885. He became one of the leading surgeons of the city, held posts of responsibility in the hospitals of the city, and from January 1, 1887, to January 1, 1890, was coroner of Lackawanna county, Pennsylvania. He was held in high esteem by his medical brethren and his fellow citizens generally. Dr. Burnett married Margaret Hart, born in New York City, daughter of Patrick Hart, born in Ireland, later a wagon manufacturer of New York City. Children: Kenneth R., of whom further; Marguerite, Vivian, John.

(III) Kenneth R. Burnett, son of Dr. John and Margaret (Hart) Burnett, was born at Carbondale, Pennsylvania, November 16, 1882. He was educated at Saint Cecelia Academy and Saint Thomas College, beginning business life as messenger in the Merchants' and Mechanics' Bank of Scranton. He received several promotions, finally becoming teller, retaining that position until elected cashier of the Pine Brook Bank, of Scranton, December, 1910, which position he now efficiently fills. He is a member of the Knights of Columbus, and of a number of clubs among which are the Catholic, Scranton, Canoe, American and Institute of Banking.

#### WILLIAM HENRY COLLINS

A descendant of Irish ancestry, Scranton is the birthplace of William Henry Collins of this record; and that city has witnessed all of his business activity, his position being that of district plant chief for the Western Union Telegraph Company.

(I) The American founder of this line was Bernard Collins, born in Queens county, Ireland, who settled in the Scranton district in 1848, where he became well known, taking an active part in the local politics of the day. His faith was the Roman Catholic, while he was a Democrat in politics; his death occurred in 1850. He married Mary Kennedy, and was the father of Thomas, of whom further; Patrick J., Michael M., Bernard M., Margaret, Catherine, Mary, all deceased.

(II) Thomas Collins, son of Bernard and Mary (Kennedy) Collins, was born in Queens county, Ireland, in 1824, and was a resident of Scranton from 1849, and nearly all of his active life was identified with the firm of Hunt Brothers, who were pioneer dealers in hardware, on Lackawanna avenue, at the corner of Washington avenue. Politically he was a Democrat; his religious belief, Roman Catholic. Thomas Collins married Julia Maloney, a native of Ennistymon, Clare county, Ireland. They were married in Scranton, May 28, 1860; Rev. Moses Whitty officiating. Julia Maloney came to Scranton in girlhood and has lived here ever since; her present home being at 733 Quincey avenue. Children of Thomas and Julia (Maloney) Collins: William Henry, of whom further; Edward Bernard, deceased; Thomas Francis; John Michael, deceased; Austin Charles, deceased; Anna L.; John Austin; Joseph, deceased; Mary Agnes; Julia Regina.

(III) William Henry Collins, son of Thomas and Julia (Maloney) Collins was born on Spruce street, Scranton, and he has always lived in the Central City. He was educated in the Scranton high schools. The Western Union Telegraph Company is practically the only employment he has ever known, and he has been associated with that concern since 1877 when he entered their

service as a messenger. He has risen from that position, through the grades of operator, chief operator and manager to his present important office of district plant chief for the Scranton district, a district comprising Northeastern and Western Pennsylvania, extending westward to Clearfield county and a part of New York state. His fidelity to the company has been proved through long years of service, during which his responsibilities have increased rapidly and the thoroughness of his training makes him an employee of value. He is a recognized authority on telegraph electrical work in his district, being an expert electrician and his duties are along the line of telegraph engineering.

Mr. Collins is financially interested in the Scranton Dime and Savings Bank. His political principles are Democratic, and although he is loyal in his support of that party and an active worker for its advancement, he has never sought the rewards of public office. He was one of the organizers of Company A, Engineers' Battalion, National Guard of Pennsylvania, the first engineer company formed in that organization in the state, and for three years served as telegraph engineer. His club is the Morse, of New York City, and he is a member of the National Geographic Society, the Benevolent and Protective Order of Elks, also being a charter member of the local organization of the Knights of Columbus. His church is the Roman Catholic, in which he belongs to the Cathedral Parish.

Mr. Collins married, in Scranton, October 27, 1891, Sarah M. Gorman, born on Scranton West Side, daughter of Charles Gorman, who journeyed to California in 1849, the time of the gold excitement. Mr. and Mrs. Collins are the parents of: Paul Gregory, a graduate of the Central High School, of Scranton, class of 1912, and at present a student at Harvard University; Albert Joseph, and Frances Marie, both students in the Scranton high schools.

---

#### ABRAHAM LINCOLN FRINK

Of New England ancestry, his father a native of Connecticut, but himself a son of Scranton, Abraham Lincoln Frink has ever been a resident of and in business in the city of his birth. His grandfather, Benajah Frink, had among his children four sons, Isaac and Tracy, both farmers at Auburn; Orrin, of whom further; William, for forty years a freight agent in the employ of the Delaware, Lackawanna & Western Railroad. Orrin, father of Abraham Lincoln Frink, was born in Connecticut, in 1807. He and his wife, Edith (Smith) Frink, were the parents of: Harriett, married Jonas Washburne; Mary, married Albert S. Whittaker, of Scranton, Pennsylvania; Cornelia, married George N. Stark; Henry Clay, married Hester Kemmins, of New York; Jessie, married Henry T. Howell; Ida, married (first) Harry G. Fuller, (second) Ellis W. Moore; Luella, married Eugene Grout, of Colorado; Abraham Lincoln, of whom further.

Abraham Lincoln Frink, son of Orrin and Edith (Smith) Frink, was born in Scranton, Lackawanna county, Pennsylvania, September 26, 1864. He obtained his education in this city, attending the public schools, also being a student in the private school of Miss Hattie Slocum, held in a building that stood on the site of the old store of O. P. Clark. One of his teachers in the old brick school house was Professor Hawker, father of James Howell Hawker, a member of the present faculty of the Scranton High School. After the old brick school-house was destroyed by fire, classes, taught by Professor J. Elliott Ross, were held in the Fellow's Building. Mr. Frink began his business career at the age of thirteen years, when he left school and entered the employ of William Watkins, a printer, with whom he learned type-setting and press running, and all the other details of the printer's trade. He gave up his

position with Mr. Watkins to enter the service of H. D. Jones, a grocer with a store on Jackson street, and was next identified with the 99c store of C. B. Nash, at 501 Lackawanna avenue, after which he became associated with Mr. Courtright, a shoe merchant. His next position was with the Delaware, Lackawanna & Western Railroad Company, and after a short term with this road he became connected with I. F. McGargle and J. L. Connell, wholesale grocers, with whom he remained for two years. Timmes & Hecht, manufacturers of railroad spikes and bar iron, then engaged his services, and upon the dissolution of this company he became an accountant in the office of the Goldsmith Bazaar. The year 1905 he passed in the employ of the General Metals Manufacturing Company, and in November, 1906, he was employed as accountant by C. S. Woolworth, of Scranton, and so continued until 1912. A change in the business affairs of that gentleman taking effect on January 1, of that year, Mr. Frink became his private secretary, still continuing in that position. Of Mr. Frink's fitness for the position in which he has been placed it can only be said that his fidelity and loyalty to his employer is unswerving, and that in the administration of the myriad details entrusted to him he has exercised judgment that has brought satisfactory and favorable results to Mr. Woolworth. His wide experience in several lines of business makes him peculiarly valuable in his present place and the arrangement between him and Mr. Woolworth has been eminently gratifying to both of the principals. No political party counts Mr. Frink as a supporter, his action in such matters being entirely independent of such association, based solely upon the merits of candidate for platform. He affiliates with the First Church of Christ, and is a member of the Modern Woodmen of America.

Mr. Frink married (first) in August, 1889, Julia A., daughter of George Herrington; (second) Lillian Hall, daughter of John Morris, of Scranton. By his first marriage he is the father of two children, Dorothy H., born February 7, 1899; James Clayton, born December, 1900.

---

#### HERMAN HAGEN

The Hagen Lumber Company of Scranton, one of the prosperous business concerns of the city, represents the efforts of Herman Hagen, who founded that company in 1906. John P. Hagen, the father of Herman Hagen, was a native of Baden-Baden, Germany, and throughout his entire life was a veterinary surgeon, dying in his native land at the age of seventy-three years. He was a participant in the revolution of 1848, and bore a proud reputation as a brave and valiant soldier. He married Marie Ann, daughter of Nepenick Foster, magistrate in the town of Galmansville, and a prominent man of that locality. They were the parents of: Ferdinand; Carl; Albert, married, in February, 1908, Margaret North, and had children, Albert Jr. and Dorothy M.; Herman, of whom further.

Herman Hagen was born in Baden-Baden, Germany, February 2, 1852, and was there educated in the public schools. After the completion of his studies and his graduation he immigrated to the United States, landing in New York City and proceeding up the river to Hudson, New York, where he engaged in truck gardening. In 1870 he moved to the city of Scranton, Pennsylvania, and for two years he was in the employ of the Iron Coal Company, for the two following years executing contracts with the city for the grading of streets. He then entered upon a sixteen years' relation with the Simon Rice Grocery Company, at the end of that time purchasing land on Washington avenue and beginning work at his early occupation, gardening, in 1880 joining his brother Ferdinand in the lumber business, on the present site

of the Hagen Lumber Company. For eight years he was a director of the German Building and Loan Association, holding the same position in the Harmony Building and Loan Association for twenty years, also with the Schiller Loan Association. Mr. Hagen has conducted several private business ventures, independent of those in which he is interested as a member of the Hagen Lumber Company, and during 1881 and 1882 purchased eleven lots, erecting modern dwellings thereon. In 1866 he purchased four hundred acres of land near Bear Lake, which he cleared, and in 1897 bought one acre of land and built six houses. In 1906 he founded the Hagen Lumber Company, owning an absolutely fire-proof mill, operating the first planing mill in the city, with individual motors on each machine. He manufactures white pine columns, interior finishings, general builders' and contractors' work, and mill work of all kinds, a busy and prosperous concern. He also assisted in organizing the Pine Brook Bank and is director of this. Mr. Hagen holds membership in the Liederkrantz and the German Alliance, beneficial societies, and belongs to the German Catholic Church.

Mr. Hagen married, in 1875, Sophia, daughter of Ferdinand Frey. Children: 1. Frederick C., born September 15, 1878; foreman of the Hagen Lumber Company. 2. Alfred P., born January 25, 1880. 3. George, born July 5, 1882; married, October 14, 1908, Nellie Harte and their children are: Hortense, George Jr., Grace Sophia, Mary and Louise. 4. August. 5. Rosa, married Edward Eisele, city controller for the past fifteen years. 6. Carl. 7. Augusta. 8. Helena.

---

#### WILLIAM EWART NAPIER

Having devoted nearly all of his active career to the insurance business, William Ewart Napier, secretary of the Scranton Life Insurance Company, came to that organization in 1908, recommended by a record of efficient service with the companies of repute, and now holds a responsible position with this institution, and one of corresponding height in the business world of his city.

His father, John Napier, was born in London, England, 1850. For twelve years he was engaged in military service, from sixteen to twenty-eight years of age, and since then until his death in 1914 was engaged in the insurance business. He married Isabella Colyer, likewise a native of England, and had children, among whom was William Ewart, of whom further.

William Ewart Napier, son of John and Isabella (Colyer) Napier, was born in Dulwich, a suburb of London, England, January 17, 1881. As a boy he was brought to Portland, Maine, and there attended the public schools, completing his education in the institutions of London, England, and Berlin, Germany. In his youth he was engaged in journalistic pursuits in New York City, and at the age of sixteen years entered his father's field, life insurance, and has since continued therein, with the exception of the years spent abroad while finishing his education. On December 16, 1908, he completed negotiations with the Scranton Life Insurance Company and accepted a position as actuary, coming to the home office in Scranton. With the recognition of his worth to the company he was advanced to the office of secretary, of which he is the present incumbent. In 1914 he was elected a director of that company, succeeding John R. Williams. He without doubt inherits a large portion of his father's aptitude for the insurance business, and in the six years of his connection with his present company has ably met every difficulty that has arisen in the company's affairs. Mr. Napier for some years found enjoyable relaxation from business cares in chess, and in 1904 held the open and amateur chess championship of Great Britain, so hopelessly beyond the under-

standing of some, but which furnishes recreation to many whose business is of so weighty a character and requiring such great mental activity that lighter amusements fail in effectiveness, and to this class belongs Mr. Napier. He is a fellow of the American Institute of Actuaries, member of the Scranton Club, the Press Club, Canoe Club, New York Press Club, Brooklyn Chess Club, City of London Chess Club, and the Scranton Board of Trade. Mr. Napier married, in 1906, Florence Holley Gillespie. Children: Muriel Victoria and Ruth Alexandra.

---

#### HERBERT ROBERT HIGHAM

Scion of an old English family, seated in Suffolkshire, England, Mr. Higham is the first of his line to settle in the United States, his father and grandfather both dying in England at a ripe age. William Higham, the grandfather, was a farmer on the old Higham homestead, married and had children, Samuel Robert; Edward, a dry goods merchant at Gloucester, England, and later manager of Denton & Holbrook, Gloucester, England, and proprietor of a variety store; John, died in Australia; Thomas; William, of further mention; Isabel; Amy.

(II) William (2) Higham, son of William (1) Higham, was born in Branfield, England, June 1, 1827, died there January 7, 1905. He was a maltster, engaging in that business all his active life. He married (first) a Miss Saunders, who bore him a son, Henry. He married (second) Elizabeth Clow, of Branfield; children: Florence Elizabeth, deceased; Charlotte, married and resides in England; Isabel, married and resides in England; Herbert Robert, of whom further; Richard; Ernest, first engineer in the British navy; George, a resident of Scranton. Elizabeth (Clow) Higham, the mother, died February 11, 1910, aged seventy-two years. She had a sister who died in 1913, aged eighty-one years.

(III) Herbert Robert Higham, son of William (2) Higham, was born in Branfield, county of Suffolk, England, March 9, 1872. He was educated in public schools, and at an early age indentured to a grocer for three years. At the end of his apprenticeship he continued in the same business, but in the town of Lafield, in the employ of Samuel Samson, being then seventeen years of age. At the age of nineteen he was a grocer's clerk at Gloucester, England, remaining until of legal age. Later he decided to come to the United States, and on April 15, 1903, he left Gloucester for Liverpool, sailing from the latter port April 28, on the steamship "Umbria" and arriving at New York, May 5, following. He continued his journey westward, arriving in Buffalo, New York, May 6, there found employment in a grocery store, remaining a month, then on June 7, 1903, came to Scranton. Six days after his arrival in the city he entered the employ of W. H. Pierce, as a clerk, and won his way upward until on the incorporation of The Pierce Company, May 15, 1912, he was chosen secretary of the company, a position he fills most capably. His associates in the company were: W. H. Pierce, president; John Hughes, vice-president; M. M. Bennett, treasurer; and D. S. Stone; the present officials are: M. M. Bennett, president; W. H. Pierce, vice-president; H. R. Higham, secretary and treasurer. Mr. Higham is a member of the Elm Park Methodist Episcopal Church and the Modern Woodmen, and in politics is an Independent. He married Nora L., daughter of George Wellington Sherwood, of Falls, Pennsylvania; child: Bessie Eleanor, born October 26, 1901.

## BENJAMIN L. LATHROP

As secretary of the general contracting corporation, Lathrop, Shea & Henwood Company, and treasurer of The Lathrop & Shea Company, contractors, Mr. Lathrop is in charge of the office business of two of the large contracting corporations of Scranton.

Benjamin L. Lathrop is a descendant of the Rev. John Lathrop, who settled in Scituate, Massachusetts, in the year 1630 A. D. James Lathrop, a descendant of Rev. John Lathrop, was a man of prominence and wealth of Brooklyn, New York, and at one time served as vice-counsel to Canada. Edward Flint Lathrop, son of James Lathrop, was born in South Hadley Falls, Massachusetts, died in October, 1910, aged sixty-one years. He was one of the contractors engaged in the construction of the Lake Ariel Section of the Erie & Wyoming Valley Railroad. He was extensively engaged in railroad and general contracting as a member of the firm of Lathrop & Shea, of New Haven, Connecticut. This firm did a vast amount of heavy work throughout the country, one of their contracts in Pennsylvania being the improvement of the Avoca yards of the Erie & Wyoming Valley Railroad. Mr. Lathrop married Nancy Lane and among their children was Benjamin L., of whom further.

Benjamin L. Lathrop, eldest son of the late Edward Flint and Nancy (Lane) Lathrop, was born at Gravesend, Long Island, New York, December 7, 1877. He was educated in the public schools of Brooklyn, graduating from high school, class of 1896. In that year he began business life, going to Pittsfield, Massachusetts, with his father, and entering the employ of Lathrop & Shea. Later he was with them at East Hampton, Connecticut, and for four years was in charge of the firm's office at New Haven, Connecticut. In 1902 he came to Scranton, Pennsylvania, as secretary of Lathrop, Shea & Henwood Company, a corporation succeeding the firm of Lathrop, Shea & Henwood. He is also treasurer of The Lathrop & Shea Company, contractors. These companies conduct large operations in different parts of the country, one of their present contracts being for a large section of the Erie Canal in New York state, widening and deepening it and building entirely new sections. Their work is varied in character; they have recently completed three buildings and a reservoir for the Farview Hospital for the Criminal Insane, and a filtration plant for Hillside Home. They excavated for and placed the concrete foundations for the new Delaware, Lackawanna & Western Railroad Station in Scranton. They have an extensive plant in constant use and a force of about three thousand men is employed by the two companies. Mr. Lathrop was one of the organizers and the first secretary of the Scranton Playground Association, and is deeply interested in this form of philanthropy. He belongs to Peter Williamson Lodge, Free and Accepted Masons; the Royal Arcanum, and the Improved Order of Heptasophs. He is a member of the Green Ridge Club, the Alpha Sigma and the Scranton Canoe Club. He is a communicant of St. Luke's (Episcopal) Parish. In political faith he is a Republican.

Mr. Lathrop married, June 1, 1909, Elsie Ruth Deubler, daughter of Otto and Frances (Jones) Deubler, of Scranton, Pennsylvania. Mrs. Lathrop is a member of the Century Club and of the Daughters of the American Revolution.

## ANGELO COMINELLI

An artist of recognized ability before coming to the United States, Mr. Cominelli has added to his fame in decorating and beautifying with his art many of the Holy places of his adopted state. As an ecclesiastical artist he has acquired much more than local fame and has also won the patronage of many





*Richard O'Brien*



persons of wealth, who have availed themselves of his artistic excellence to beautify their homes in some especially desired particular. An artist by in-born talent and years of study and with a reputation in his own land as an instructor in art and as an artist, he has maintained studios in Philadelphia, New York and Scranton with successful results. His immediate forbears were not artists, but men of mechanical and business ability. His grandfather, Faustino Cominelli, was manager of a large landed estate in Italy, and had children: Louis, Antonio, John, Catherine, Mary, Leander and Stephano. Louis Cominelli married Annunciate Rossini and had issue: Angelo, of whom further; Mary; Ermenia; Peter, deceased; Gildo; Faustino; Catherine, deceased; Joseph; John; Julia, deceased; Louisa, deceased.

Angelo Cominelli was born in Milzanello, Province of Brescia, Italy, January 21, 1857, and three years afterward was brought by his parents to Manorbio, same province. He attended the public schools and began special study as a student of architecture under Professor Archieno. He did not pursue this course to its end, but abandoning it went to Milan, taking lessons in painting under a capable instructor at the academy of Brera. He continued his art studies until he was of legal age, then in accordance with Italian law he joined the army and rendered his three years of military service. After leaving the army he was appointed professor in the art school of Brescia. Later he opened a private studio in Brescia, and from then until his departure for the United States was engaged in different forms of interior decoration, chiefly the adornment of churches or church institutions. He rose to fame in his art and specimens of his handiwork in his native land are notably, the ceiling of the Feraioli palace at Setigo, the St. Lawrence church, Verolanuorg, and the Church of Saint Gregory at Cané. He was a member of the Artists' Society of Brescia, a city of great antiquity and the former seat of school painting of great merit, to which many eminent artists belonged. From such an art centre and with a reputation well established, Mr. Cominelli came to the United States influenced by the general feeling existing that this was the land of great opportunity. He arrived at New York City, December 24, 1901, and at once proceeded to his intended destination, Philadelphia. He spent two and a half years in that city, then was in New York City two years in the employ of a large contracting firm who utilized his talents as a designer and interior decorator in allegorical painting, relief, figures and purely ornamental work. He came to Scranton in 1905 and at once opened a studio at rooms Nos. 9, 10 and 11, No. 134 Wyoming avenue, devoting himself to different forms of ecclesiastical art, and has successfully established a business and reputation that has brought him fame as well as remuneration. Among the many enduring monuments to his artistic skill, the more notable are: The Mortuary Chapel in Cathedral Cemetery, Scranton; Mount Saint Mary's Chapel, Scranton; Saint Mary's Church, Avoca, Pennsylvania; Poli theatres at Wilkes-Barre, Pennsylvania, and Meridan, Connecticut; Mortuary Chapel in Cathedral Cemetery, Syracuse, New York; Saint Lawrence Church, Old Forge, Pennsylvania; Holy Rosary Church, Wilkes-Barre, and the entire interior decoration of Saint Paul's Convent Chapel, Scranton.

---

#### RICHARD O'BRIEN

Richard O'Brien, assistant superintendent of the Western Union Telegraph Company, has been a prominent citizen of Scranton for many years. Born in Ireland in 1839, he came to Philadelphia in 1852. He has been identified with the telegraph and telephone from the beginning of those great inventions, having worked on Morse's first wire between Philadelphia and Pittsburgh, and on

the Pennsylvania Railroad lines in the same region until the outbreak of the Civil War which found him as division operator of the middle division of that road at Harrisburg.

With Andrew Carnegie and three other young men from the Pennsylvania Railroad, Mr. O'Brien became one of the pioneers in military telegraphy, and as that service for the first time in history demonstrated the strategic importance of the telegraph in war, one of its most successful officers in the field and front was Richard O'Brien. As chief operator, Department of Virginia and North Carolina, he built and managed lines about Fort Monroe, Norfolk and Suffolk before and during McClellan's campaign on the Peninsula, on the James river and in front of Richmond and Petersburg during Grant's campaign, and in North Carolina for Sherman's campaign of the Carolinas. In aiding to connect up these armies by telegraph Mr. O'Brien received the commendation of the War Department and of the commanders of the field, including Generals Sherman and Grant.

At the close of the war Mr. O'Brien was placed in charge of the commercial lines in Virginia and North Carolina by the American Telegraph Company, and after reconstructing and putting them in good order was transferred to New York. When that company was merged in the Western Union, Mr. O'Brien was placed in charge of lines in New Jersey and Pennsylvania on the routes of the Delaware, Lackawanna & Western, the Lehigh Valley, the Central Railroad of New Jersey and other roads, with headquarters at Scranton. Mr. O'Brien constructed the first telephone lines here in 1877, and built up the first telephone system in Northeastern Pennsylvania. He is a director of the Bell Telephone Company of Pennsylvania, a director of the Peoples National Bank, first vice-president of the Scranton Real Estate Company, and has been and still is active in the business life of Scranton.

In 1868, Mr. O'Brien married Sarah Harrison Marks, of Petersburg, Virginia, who was a descendant on the maternal side, of General William Henry Harrison, ninth president. This estimable lady died in Scranton in 1896. They had three sons: Richard Marks O'Brien, John Harrison O'Brien, and Albert Chandler O'Brien, the first of whom alone survives. Richard Marks O'Brien married, January 14, 1891, Mary Agnes O'Malley of Wilkes-Barre, and has an interesting family: Marjorie, who died greatly beloved, in 1898; Helen, Mary; Alice; Grace and Richard.

It would be a very inadequate synopsis of Richard O'Brien's career that would fail to mention the potent influence for good that his life and example have impressed on hundreds of young men and women who have worked and progressed under his direction in military and civil telegraphy and with the telephone; his kindly sympathy, cheerful encouragement and high intelligence have always evoked the steady loyalty and best efficiency of these worthy young people. Few men of Scranton have been more widely known or more highly respected than Richard O'Brien.

---

#### JOHN EMMET O'BRIEN, M. D.

The subject of this sketch was born in Ireland, in 1848, and came with his parents and older brothers, Richard and James, and sisters, Mary and Elizabeth, to Philadelphia, in 1852. His early education was less in the schools than in the telegraph profession, in which he was the youngest operator of his time, in both commercial and military service. With his elder brother Richard he served as operator and cipher-operator in the army of the United States throughout the Civil War.

At the close of the war young O'Brien, yet only seventeen, began the study



*John E. O'Brien, M.D.*



of medicine in the medical department of Georgetown University, continuing his course at Rush Medical College, Chicago, and graduating in 1869. After some practice east and west, he was appointed a lecturer in Rush College, and was in the great Chicago fire in 1871, after which he located in Scranton, Pennsylvania. Dr. O'Brien was one of the first surgeons of Lackawanna Hospital, now the State Hospital, and made the first amputation in it, in 1872. He served on the hospital staff seven years. He was the second health officer of Scranton, was surgeon of the Thirteenth Regiment three years, and is a member of the National, State and County Medical societies, and an ex-president of the latter. Dr. O'Brien has been a contributor to medical and general literature in journals of worldwide circulation, and is the author of "Telegraphing in Battle," a book of reminiscences of the Civil War. The chapter on the medical profession in this "History of Scranton," (Lewis Historical Publishing Company, New York), was prepared and written by him.

In 1877 Dr. O'Brien was married to Miss Clara B. Keves, of Beech Creek, Pennsylvania. They have one daughter, Fannie May O'Brien. Dr. O'Brien is still in active practice.

---

### JAMES JEROME BELDEN

The Spencer Heater Company, of Scranton, Pennsylvania, has as its secretary and treasurer James Jerome Belden, one of the younger members of the industrial and business world of this city. He is a member of a New York family, grandson of Augustus Caldwell Belden, a banker and contractor, who married Roselia Jackson. Children of Augustus Caldwell and Roselia (Jackson) Belden: James Mead; Alvin, married Augusta Pharis; Charles Gilbert, deceased, married Mary Bevan, and had children, Arthur Bevan, Roselia, Charles Gilbert Jr. James Mead Belden, son of Augustus Caldwell and Roselia (Jackson) Belden, was born in Syracuse, New York, married, and has children: 1. Mead Van Zile, born in 1879; associated with the Iroquois Pottery Company, of Syracuse, New York; married Nellie Blanchard, of East Orange, New Jersey, and has children, Augustus Caldwell and Mary Elizabeth. 2. James Jerome, of whom further. 3. Augustus Caldwell, born in 1883; married Ethel Butler, and has children. 4. James Mead Jr. 5. Perry, born in 1885; secretary of the American Legation at Tegucigalpa, Honduras, Central America, formerly private secretary to Charles S. Francis, ambassador to Australia, and secretary to the ambassador to Germany.

James Jerome Belden, son of James Mead Belden, was born at Syracuse, New York, December 5, 1881. His preparatory education was obtained in the public schools of his native city and Preparatory School of Lawrenceville, New Jersey, after which he matriculated at Princeton University, Princeton, New Jersey. In 1907 Mr. Belden received his B. S. from this institution, and after his graduation embarked upon a trip around the world, in the course of which he visited the many places of scenic and historic interest with which the Old World abounds, the tour one of value and enjoyment. After his return from abroad Mr. Belden resided in Troy, New York, for one year, in January, 1908, coming to Scranton to accept the joint office of secretary and treasurer of the Spencer Heating Company. The six years during which he has been the incumbent of this position have been years of prosperity and advancement for his company, the burden of added responsibility and duty that has been laid upon him through this expansion having been assumed in an able manner and welded into his plan of operation easily and with energetic competence. Should Mr. Belden make Scranton the permanent scene of his business life, the years immediately at hand must witness a broader application of his talents, a wider

field for his useful efforts. He is a member of the Scranton, Country and Princeton clubs, and belongs to the Second Presbyterian Church. His political faith is Republican.

Mr. Belden married Helen Elizabeth, daughter of Colonel H. M. Boies, of Scranton, and has one daughter, Elizabeth Boies, born August 12, 1911.

### HUGH JENNINGS

Familiarly known as "Hughey," Mr. Jennings, although educated and trained for the legal profession, is not unknown to fame as the expert ball player and successful manager of the strong Detroit Base Ball Team, thrice champions of the American League. Always an ardent devotee of all athletic sports, he was early led into the ranks of professionals, and himself a living argument, he is also one of the most ardent advocates of their value, and in public gatherings, loses no opportunity to impress upon young men the need of clean living and of trained muscles to supplement and give power to brain and mind.

He is the son of James and Norah (Feehan) Jennings, the former born in Westport, Ireland, coming to the United States when young and locating in Carbondale, Pennsylvania, where he was a mine carpenter. Children: Thomas, Frank, Nellie, Hugh, of whom further; Joseph, a practicing physician of Pittston, Pennsylvania; William A., a lawyer of Scranton; Alice.

Hugh Jennings was born in Pittston, Pennsylvania, April 8, 1870. His early education was obtained in the public schools of Moosic, Lackawanna county, Pennsylvania, Wood's Business College, Scranton, after which he pursued a course of study at Saint Bonaventure College, Allegany, New York. When he decided upon the law as a profession, he entered the law department of Cornell University, whence he was graduated LL. B., class of 1904. He was admitted to the Maryland bar, at Baltimore, in 1905, and in 1907 to the Pennsylvania bar, becoming law partner with his brother, an association that still continues, although it is only between seasons that he engages in the active work of the firm, and then as an assistant to his able brother, William A. Jennings. The offices of the firm are Nos. 703-704 Mears Building, Scranton, where a lucrative law business is transacted. In 1890 Mr. Jennings first became a professional ball player, his first engagements being with the Allentown and Harrisburg clubs. In 1891 he was with the Louisville Club of the American Association, remaining until 1893, when he joined the Baltimore Club, of the then National League. For six years he remained with that club, being one of the number who was conspicuous in its success and who have in other fields gained national fame. From 1899 until 1901 he was a member of the Brooklyn Club of the National League, then with the Philadelphia Club until 1904, becoming in the latter year manager of the Baltimore Club of the Eastern League, remaining until 1907, when he was chosen manager of the Detroit Club of the American League, leading that team to victory as champions in 1907-1908 and 1909. During his professional ball career he has been a member of eight championship and of fourteen second place teams. The Blue Ribbon of the Base Ball world has, however, been as yet denied him, the Detroitis having failed of securing victory in a "World's Series" over their National League opponents, Chicago and Pittsburgh. As a player "Hughey" was one of the most reliable, ranking with the leading men of his generation, as a manager he is most capable and popular with the base ball public, always receiving a royal welcome when appearing at the ball parks of the league cities. He is genial, generous and joyful, fair and honorable in his methods of conducting a game, not cast down by defeat or unduly elated over a victory, a good winner and better still a good loser. During the winter season of 1912-1913 he

filled an engagement in vaudeville over the Keith circuit, presenting a pleasing act in company with an assistant.

It must not be supposed that Mr. Jennings holds the profession of law lightly or that base ball is his ruling passion. Brain and muscle have developed side by side and while known only as the ball player to the world at large, to his friends and acquaintances he is known as the educated lawyer, the fluent and pleasing speaker, and earnest advocate of education and good citizenship. He keeps in close touch with the legal profession and his ultimate ambition is to make for himself a name among the leaders of that profession. He is a member of the Benevolent and Protective Order of Elks, the Knights of Columbus and the Loyal Order of Moose. His college fraternities are Phi Delta Theta, Phi Delta Phi, his college society, Sphinx Head, all of Cornell University.

Mr. Jennings married (first) in 1898, Elizabeth Dixon, of Avoca, Pennsylvania, who died in 1899, leaving a daughter, Grace, born September 4, 1899. He married (second) in 1910, Norah O'Boyle, of Scranton; a daughter died in infancy.

---

#### ALFRED GUTHEINZ

One of the youngest of the business men of Scranton, Alfred Gutheinz has still identified himself with so many of the institutions of that city that he holds a position of more prominence than that of many whose lifelong home has been in Scranton.

Mr. Gutheinz was born in New York City, New York, in 1875, and there attended the public schools. When he was sixteen years of age his parents moved to Scranton and soon after his arrival he entered Wood's Business College in order to prepare for his future career. His first business experience was in the employ of the Wightman Electric Company, with which concern he remained for two years, afterwards being identified with the Scranton Supply and Machinery Company for a period of three years. In 1899 he made his entry into the banking field of the city as bookkeeper in the Scranton Savings Bank, later being promoted to paying teller. This position he held until June 20, 1912, when he was elected cashier of the South Side Bank, resigning his place with the Scranton Savings Bank to enter the service of the former institution. He still serves the South Side Bank in this capacity, his performance of the duties of his office giving satisfaction to all concerned. Mr. Gutheinz is a Democrat in political faith and has always been foremost in the affairs of his party, having been a member of the Democratic county committee, of which he had the honor to be treasurer. He is a trustee of the Scranton Public Library, and played a prominent part in the organization of an association for which Scranton is noted, the Junger Mannerchor, having been president of that body. He also takes great interest in the choir of the First German Presbyterian Church, of which he is a member. Mr. Gutheinz fraternizes with the Masonic Order and the Patriotic Order Sons of America. He is a member of the Associated Board of Charities.

Mr. Gutheinz married, in 1902, Lydia F., daughter of John and Caroline Sailer, of South Scranton. Children of Alfred and Lydia F. Gutheinz: Stephen A., born February 26, 1907; Carl William, born September 29, 1911. The varied natures of Mr. Gutheinz's relations to Scranton's interest stamp him at once as a man of exceptional versatility, as well as one whose sympathy is wide and all-embracing. He is the type of citizen that tends to make the development of a city uniform in all departments, not uneven and disproportionate, and his further activity will surely be productive of good results.

## MAX FREDERICK HENKELMAN

Born in Germany, but a resident of Scranton since 1893, Mr. Henkelman has, through merit and agreeable personality, won both position and friends in this city. He is a son of Frederick and Ernestine (Sonntag) Henkelman. His father died July 1, 1909.

Max F. Henkelman was born at Breslau, Germany, February 28, 1887. At six years of age he was brought to Scranton by his parents and here obtained his education, being graduated from the Scranton High School in the class of 1902. In September of that year he entered the employ of the legal firm of Willard, Warren & Knapp, now Warren, Knapp, O'Malley & Hill, as clerk, and has since continued with them and at the present date (1914) has charge of their title work. He is a director in the Economy Building and Loan Association. Mr. Henkelman is also active in fraternal organizations, and is a member of Schiller Lodge, No. 345, F. and A. M.; Scranton Aerie, No. 314, F. O. E.; Pocono Tribe, No. 230, I. O. R. M.; and the Junger Mannerchor, of Scranton. In politics he is a staunch Republican; is ex-president of the South Side Republican Club, and secretary of the Republican County Committee (1914). In religious faith he is a Presbyterian, belonging to the First German Presbyterian Church.

Mr. Henkelman married, September 3, 1913, Emilie C., daughter of Peter P. and Emilie (Art) Neuls, and granddaughter of Adam Neuls, one of the early settlers in Scranton. One son, Willard Max Henkelman, has been born to them.

---

 ROBERT LEO HUBER

For fourteen years Mr. Huber has been associated with the Jermyn Estate in Scranton, rising from office boy to the position of private secretary to Joseph Jermyn, one of the executors. Mr. Huber has been a worker since his thirteenth year and is untiring in his devotion to the interests of his chief. During the recent mayoralty campaign in Scranton, he acted as manager of important details connected therewith, rendering valuable and well appreciated service in behalf of the successful candidate, Edmund B. Jermyn.

Mr. Huber was born in Scranton, Pennsylvania, March 9, 1884. He obtained his early education in the public schools of the city, supplementing this by several terms in the night school at Scranton Business College. At age of thirteen he became cash boy at the "Globe Store," continuing two years, then attracting the attention of Mr. Jermyn he was offered a position in his office. He began as office boy, and so won the confidence of his employers that he is now secretary to the executors of the estate and private secretary to Joseph Jermyn. Mr. Huber is a thirty-second degree Mason, belonging to all constituent bodies of Keystone Consistory, Ancient Scottish Rite; is a noble of Irem Temple; financial secretary of the Temple Club; member of the Scranton Canoe Club, of which he has been secretary and treasurer. He is well known in this city and held in favorable esteem by his wide circle of friends.

---

 RALPH AMHERST GREGORY

For more than fifteen years connected with financial institutions of the city of Scranton, including the Title Guarantee and Trust Company, the County Savings Bank, and the Third National Bank, of which last he is now credit manager and assistant cashier, Ralph Amherst Gregory had previous business connections in Scranton, associations which were discontinued to form others



in the city of Wilkes-Barre, Pennsylvania. These were broken to permit Mr. Gregory to enlist in the army in the war with Spain, and since the close of that conflict he has resided in Scranton.

He is a member of a family old in Pennsylvania, great-grandson of Israel and Polly (Lindsay) Gregory. His grandfather, Amherst Lindsay Gregory, was born in Bridgewater, Pennsylvania, March 15, 1821, and during his active life was a farmer. He married (first) at Deposit, New York, in January, 1851, Clarissa Mary Hollister, (second) August 31, 1875, Elizabeth Hitchcock.

Marion Albert Gregory, son of Amherst Lindsay Gregory, was born in Hollisterville, Pennsylvania, September 20, 1854, and has always followed the mechanic's trade. His political party is the Republican. He married, October 9, 1876, Lillian, born in Dunmore, Pennsylvania, April 25, 1854, daughter of Harrison and Sarah Ann (Hollister) Stevens. They are the parents of children: Ralph Amherst, of whom further; Leona, born June 15, 1879, married Gustav Dogelsberger.

Ralph Amherst Gregory, son of Marion Albert and Lillian (Stevens) Gregory, was born in Hollisterville, Pennsylvania, August 17, 1877. After attending the public schools of Scranton he became a student in the School of the Lackawanna, where he finished his education. He then began his business career with the stationery firm of Price & Rose, well known in the city, and after three years passed with this concern was employed in the office of Colonel Watres. Moving to Wilkes-Barre, Pennsylvania, he became associated with the Spring Brook Water Supply Company, of that city, and when war with Spain was declared he enlisted in the Thirteenth Regiment Pennsylvania Volunteer Infantry. When his company was mustered out of service in Georgia he held the rank of corporal. Returning to Scranton he was for three and one-half years connected with the Title Guarantee and Trust Company, then entering the County Savings Bank, where he was employed for four years. In 1907 he was appointed to the position of credit manager and later assistant cashier in the Third National Bank of the city, the duties of which he now capably performs. His offices are those of trust and responsibility, and in their administration he has exercised initiative and judgment that have won for him the approval of his superiors in office, his intelligent solving of the problems that daily confront him redounding to the benefit of the institution by which he is employed.

Mr. Gregory has been interested in matters military since his service at the time of the Spanish War, and is now captain of Company D, Thirteenth Regiment National Guard of Pennsylvania, his company the equal of any in the regiment in discipline and training. He fraternizes with the Masonic Order, belonging to Peter Williamson Lodge, No. 323, F. and A. M., and holds membership in the Scranton Canoe Club. His church is the Elm Park Methodist Episcopal, and he is a supporter of the Republican party.

Mr. Gregory married Grace A., daughter of William H. and Arminda (Kyte) Peck, of Scranton. Mr. and Mrs. Peck are the parents of: William J., Nelson, Alice, married a Mr. Kaiser, and Grace A., of previous mention, married Ralph Amherst Gregory.

---

#### ARTHUR CLARK LeMONTE

The three generations of the LeMonte family who find particular mention in this record have divided their activities between New York and Pennsylvania, coming to the latter state from the former. Professional prestige, medical and pedagogical, belongs to the name in the first two generations through the distinguished service of Professor Wellington LeMonte, prominent

in educational circles in Pennsylvania and New York, and Dr. William LeMonte, a physician of New York, member of the state assembly and for many years president of a theological seminary. The Scranton representative of the present day is Arthur Clark LeMonte, chief engineer of the coal department of the Delaware, Lackawanna & Western Railroad, and since 1889 connected with the industrial world of Scranton as an employee of that company.

(I) The American history of the LeMonte family began in the seventeenth century when members thereof fled from France, their native land, at the revocation of the Edict of Nantes, and settlement was made in the American colonies, New York being the home of the branch to which Arthur Clark LeMonte belongs. William LeMonte, grandfather of Arthur Clark LeMonte, was a medical practitioner of Charlotteville, New York, and was called from his practice to serve a term in the New York legislature. He also for many years held the presidency of a theological seminary in that state, a man of wide influence and high standing throughout the state. He married Anna Van Roman and they had twelve children, among them Wellington, of whom further; George, Samuel, Thomas.

(II) Wellington LeMonte, son of William and Anna (Van Roman) LeMonte, was born in Charlotteville, New York, December 20, 1833, and was educated in Union College. After graduating he became professor of mathematics in Wyoming Seminary of Kingston, Pennsylvania, but later resigned from that institution to accept the superintendency of schools in Wyoming county, Pennsylvania, an office he held for two terms. He then became principal of a school in Scranton where he remained one year. Then he retired to his native state where he became the head of Canisteo Academy and there spent the remainder of his life. He was ever a deep student and a scholar of broad culture, and in imparting his knowledge to others was most successful. His ideas and ideals of education were liberal and exalted, but withal practical, and as head of various educational institutions he secured results valuable and far-reaching. He married Frances M., daughter of Stephen Clark, one of the first coal operators in Carbondale, Pennsylvania, promoter of the Bell Mont Coal Mine. Stephen was a brother of Judson Clark, one of the earliest coal operators in Scranton who opened the Clark vein at the "Notch." Children of Wellington and Frances M. (Clark) LeMonte: Bertha, deceased; Anna, deceased; Wellington, secretary of the Tintern Manor Water Supply Company, of Long Branch, New Jersey, married Natalie Kirk; William, deceased, an early employee of the International Correspondence Schools of Scranton; Arthur Clark, of whom further.

(III) Arthur Clark LeMonte, son of Wellington and Frances M. (Clark) LeMonte, was born in East Worcester, New York, October 31, 1869. He was educated in the public schools of Scranton, graduating from the high school in 1888, then becoming attached to the engineering department of the Delaware, Lackawanna & Western Railroad. This corporation has since been his employer, his present rank being that of chief engineer of the coal department. Faithful and competent service has characterized Mr. LeMonte's connection with this concern, the reward of which has been his steady elevation to the important place he now fills. He has left behind him a record of which he may well be proud, and in so doing has gained many firm friends among his fellowworkers, whether they have been his superiors or his inferiors in station. Mr. LeMonte is president of the Railroad Young Men's Christian Association of Scranton, and ex-president of the Engineers' Society of Northeastern Pennsylvania. His church is the First Presbyterian, in which he is a ruling elder, and he fraternizes with the Masonic Order, belonging to



*A. C. La Monte*



Peter Williamson Lodge, No. 323, and the Modern Woodmen of America. His political stand is independent of party alliance. Mr. LeMonte is a gentleman of extensive influence, always justly exercised, and bears among a large circle of friends a reputation for sterling worth and merit.

Mr. LeMonte married, in October, 1899, Luella, daughter of W. S. Frace, postmaster of Clarks Green and Clarks Summit. W. S. Frace died in 1912. Mr. and Mrs. LeMonte have one son, William Frace, born March 9, 1906.

---

#### REV. VICTOR GURISATTI

Educated and trained for the priesthood of the Roman Catholic church in Italy, his native land, Rev. Victor Gurisatti has for the past seven years been identified with the church of his faith in the United States, the last six years of that time as pastor of St. Lucia's Church. He is a son of Dominick Gurisatti, born in Gemona, province of Udine, Italy, about 1813, died in 1871. He married Catherine Lepore, and had children: Anna; Pius, entered the priesthood of the Roman Catholic church and for twenty years has been General Superior; Esther, a sister in a convent at Milan; Antonio, a printer and stationer of Verona, Italy; Victor, of whom further; Adele, a sister in a Verona convent; Eustachio, professor of Belle Art in Florence, Italy.

Victor Gurisatti, son of Dominick and Catherine (Lepore) Gurisatti, was born in Gemona, province of Udine, Italy, July 25, 1866. For eleven years he was a student in the Stimatini Institute of Verona, at the end of that time engaged in business in that city, at the same time studying and performing missionary work in preparation for the priesthood. He was ordained on November 23, 1890, by Cardinal Aloysius Di Cunnosa, and from that time until 1907 was engaged in priestly duties in his native land, in that year immigrating to the United States, arriving in New York City on November 2. For six months he was connected with mission work in Hazleton, Pennsylvania, at the expiration of that time going to North Adams, Massachusetts, and on September 3, 1908, becoming parish priest of St. Lucia's Church, Scranton, Pennsylvania, and has ministered to the needs of that congregation to the present time. On October 24, 1913, work was begun on the foundation of a new house of worship for the St. Lucia congregation, and so rapidly did operations progress that at midnight on Christmas the first mass was celebrated in the new building, the congregation taking formal possession on January 26, 1914. When the finishing touches have been made upon this edifice a house of worship will stand of which the people and the city may well be proud, and especial gratification should come to Rev. Gurisatti for the part of leadership he has been permitted to play. At the present time a mission church, under the care of St. Lucia's, is in the course of construction at No. 621 Janet street, and will be ready for dedication and occupancy by Easter of the present year (1914).

Father Gurisatti is assisted in his work at St. Lucia's by Rev. Joseph Nardon, a native of Lesignago, Trent, Italy. He is a son of Armadio Nardon, who married Eugenia Ferretti, and had children: Jerome, John Baptist, Michael, Joseph, Eugenio, Nicholas, Theresa, Oliva, Rosa, Caroline. Joseph Nardon spent eleven years as a student in the Stimatini Institute of Verona, as did Rev. Gurisatti, and after participating in the missionary work of the church in his native land was ordained into the ministry and came to the United States, June 3, 1907. For a year and a half he engaged in missionary work in Hazleton, Pennsylvania, and for the following fifteen months was in North Adams, Massachusetts, later spending three and a half years in Springfield,

Massachusetts. In August, 1913, he was appointed assistant priest at St. Lucia's Church in Scranton, where he has since remained, ably seconding the work of Rev. Gurisatti.

### JOHN NELSON GARRETT

This name has various forms in the early records of New England, such as Garrad, Garrard, which might indicate German or French origin. The name may have originated from the baptismal name Garret or Gerrit, but its origin is now lost in uncertainty. There were many of the name in early New England. Deacon Richard Garrett, sometimes written Gannett, first town clerk of Scituate, Massachusetts, being located there as early as 1636. James Garrett was in Charlestown, Massachusetts, in 1637, and Hugh and Herman Garrett are found of record the following year.

(I) Daniel Garrett, born in 1612, was one of the original proprietors of Hartford and appears in the records as early as 1640. For many years he was prison keeper there and was living as late as 1687. He had sons, Daniel, born 1647, and Joseph, of whom further.

(II) Joseph Garrett, son of Daniel Garrett, born 1650, was a sergeant in the French War, and was residing in Hartford in 1696. He bought property in Wethersfield, Connecticut, in 1705, possibly in that portion of the town which became Glastonbury as he became a resident of that town in 1729. He married (first) about 1678, Mary, daughter of Edward Elmer, and (second) June 2, 1702, Sarah, daughter of Jacob Johnson. His only child found of record was Prudence, born September 27, 1711, and Francis, of whom further.

(III) Tradition says that Francis Garrett, a resident of the present town of Canton, Connecticut, formerly known as West Simsbury, was of French origin but it seems extremely probable that he was a son of Joseph Garrett, of Hartford and Wethersfield. He married, about 1722, Sarah, daughter of Sarah (Pettibone) Mills and widow of Samuel Tuller, of Simsbury, born 1696, died 1797 in her one hundred and first year. Children: Samuel, born January 22, 1724; Susan, October 2, 1725; John, of whom further; Francis, October 4, 1729; Anna, September 15, 1731; all recorded in Simsbury.

(IV) Major John Garrett, eldest son of Francis and Sarah Garrett, was born August 15, 1727, in Simsbury. He was a soldier in the Revolutionary War, slain by Indians in Pennsylvania, July 3, 1778. His wife and children, having been previously instructed, escaped the Wyoming Massacre, and made their way through the woods into southern New York, where Mrs. Garrett supported her children by working in the harvest fields and finally made her way back to Connecticut. Their sons were: Wait, Mills, John, Francis, the latter born after the return of the mother to Connecticut.

(V) Wait Garrett, probably eldest son of Major John Garrett, resided in Wyoming Valley where he was taxed in 1775-77. Very little can be learned about him except that he had sons: Amasa, born 1778, died in Southbury, Connecticut, June 1, 1792; another child unnamed, died March 25, 1781. He was probably the father of the next mentioned John Samuel, about whom little can be learned.

(VI) John Samuel Garrett, son of Wait Garrett, resided in Indian Orchard, in the township of Berlin, Wayne county, Pennsylvania, where he was a farmer and lumberman. He married Patience Content Albro, a native of Connecticut. Children: John Samuel, mentioned below; Sheppard, died at Beach Lake, 1911; Lyman Raymond, a farmer now residing on the old homestead at Indian Orchard; Eunice, wife of William Noble, deceased; Patience, Mrs. Mark Compton, of Indian Orchard, deceased.

(VII) John Samuel (2) Garrett, son of John Samuel (1) and Patience C. (Albro) Garrett, was born December 19, 1831, at Indian Orchard, died at Indian Orchard, 1894. He was there engaged in farming. He married Elizabeth Braman, born in 1830 in Cooperstown, New York, daughter of Rhodes Braman, who removed from Cooperstown to Indian Orchard about 1842. Children: 1. Catharine Sarah, born March 19, 1862; married William Henry Treverton, of Scranton, and died March 22, 1907, leaving a son, Rexford Eugene. 2. Effie Viola, born February 21, 1864; married William H. Hall, of Indian Orchard, and has children, Nellie and Harold. 3. Henry William, born July 8, 1868; now residing at Pittsburgh, Pennsylvania. 4. Elizabeth Jane, born June 16, 1871; wife of James R. Wrenn, of Hawley, Pennsylvania, and has daughters; Melva and Catharine. 5. John Nelson, of whom further.

(VIII) John Nelson Garrett, youngest child of John Samuel (2) and Elizabeth (Braman) Garrett, was born May 6, 1874, at Indian Orchard, Pennsylvania. He was educated in the public schools at that place and Wood's Business College, Scranton, Pennsylvania. He began his business life as a bookkeeper for the Elkhill Coal & Iron Company, in which capacity he served fifteen years. In 1908 he became associated with the Valley Supply Company of Scranton, which deals in mine, mill and railroad supplies, with offices in the Coal Exchange Building at Scranton. Mr. Garrett fills the responsible position of manager and treasurer for this concern; he is also treasurer and manager for the Impervious Paper Company of Stillwater, Pennsylvania. He is actively identified with the Masonic fraternity, affiliating with Green Ridge Lodge, No. 597, F. and A. M.; Chapter No. 185, R. A. M., of Scranton; Melita Commandery, No. 68, K. T., of the same place. He has taken all the Scottish Rite degrees up to and including the thirty-second. He has served as senior and junior warden of the Green Ridge Lodge; is a member of the Mystic Shrine of Wilkes-Barre and of the Keystone Bodies of the Valley of Scranton. He is also a member of the Green Ridge Lodge, No. 603, I. O. O. F., of Scranton; of the Green Ridge Club; of the New England Society of Northeastern Pennsylvania; and the Green Ridge Baptist Church of Scranton.

Mr. Garrett married, October 20, 1897, Ella, daughter of Andrew B. and Caroline (Ellis) Lidstone.

---

#### ANDREW M. FINE

Prior to 1872 Martin L. Fine, father of Andrew M. Fine, was a resident of New Jersey, the state of his birth. He was born in Hunterdon county, New Jersey, February 26, 1851, died August 1, 1908. He was educated in public and private schools, beginning his business life as clerk in the postoffice at Belvidere, New Jersey. In 1872 he came to Scranton, entering the employ of the Delaware & Hudson Company in the coal sales department, and continuing until his death. In 1891 he was appointed shipping agent, and filled that position during the last seventeen years of his life. In 1873 he married Limella Chambers, of Belvidere, New Jersey. She was born at Polkville, New Jersey, July 31, 1849, died October 7, 1912. During their entire life in Scranton, Mr. and Mrs. Fine resided in the Green Ridge section.

Andrew M. Fine, only child of Martin L. and Limella (Chambers) Fine, was born in Scranton, Pennsylvania, June 27, 1875. He was educated in the city public schools, a graduate of the high school, class of 1891, and of the School of the Lackawanna in 1892. His first position was with the Delaware & Hudson Company in the coal sales department, beginning in August, 1892, his service with the company having been continuous since that date. In May, 1903, he was appointed auditor of the coal sales department. On November 1,

1907, he was appointed to the office of auditor of the coal department. Mr. Fine married, November 2, 1905, Helen, daughter of Valentine Bliss, of Scranton. They have one child, Valentine Luther Fine. The family residence is at No. 1607 Sanderson avenue.

#### GEORGE BECK DIMMICK

The ancestral line of Mr. Dimmick traces to England, whence came Thomas Dimocke, the emigrant ancestor. The name is spelled in New England records Dimocke, Dimmock and Demmock. The present spelling also varies, but the Scranton branch spells, and has for several generations spelled, the name Dimmick. The American records began at Barnstable, Massachusetts, where to Elder Thomas Dimocke and Rev. Joseph Hall was granted a patent of that town in 1639. In his nuncupative will, dated June 4, 1658, recorded in vol. 2, page 75, Probate Records, Plymouth, Massachusetts, Elder Thomas spelled his name Dimocke.

(II) He had but one son who reached years of maturity, Ensign Shuabel Dimocke, who was a man of importance in his town. He married, before he was nineteen years of age, Joanna Bursley, aged seventeen years. "At her death they had lived in the married state sixty-four years." Children: Thomas, born in April, 1664; John, January, 1666; Timothy, March, 1668; Shuabel, February, 1673; Joseph, September, 1675; Mehitabel, 1677; Benjamin, March, 1680; Joanna, March, 1682; Thankful, November, 1684.

(III) Timothy Dimmock, third son of "Ensign" Shuabel Dimocke, married Abigail ———, and had issue, among whom was a son, Shuabel.

(IV) Shuabel (2) Dimmock, son of Timothy Dimmock, was born May 27, 1707. He married, January 25, 1739, Esther Pierce, "daughter of Samuel Pierce, of Mansfield" (Connecticut).

(V) Captain Edward Dimmick (as we shall now write the name), son of Shuabel (2) and Esther (Pierce) Dimmock, was born June 5, 1748. He served in the Revolutionary War and is said to have remained in New York until the very last minute when the American troops evacuated that city, only leaving with the last boat-load of soldiers. He married (first) Peninah Hinckley, whose six children all died in infancy. Her tombstone bears this inscription: "In memory of Mrs. Peninah, wife of Captain Edward Dimock, who departed this life, July 1, 1878, in ye 44 year of her age." Captain Dimmick married (second) Esther, daughter of Joshua Tilden, of the same family from which sprang Governor Samuel J. Tilden, the famous New York statesman and lawyer. By his second wife there were eleven children, including two sets of twins.

(VI) Eber Dimmick, son of Captain Edward Dimmick and his second wife, Esther (Tilden) Dimmick, was born December 31, 1792. He married Roxy Mumford, and had eight children.

(VII) Eber (2) Dimmick, youngest son of Eber (1) and Roxy (Mumford) Dimmick, was born May 25, 1834. He married, October 10, 1861, Eleanor Mary, daughter of George Beck, and they had the following children: George Beck, of whom further; Eugene Eber, born September 3, 1864, died October 28, 1870; James Orville, born December 19, 1866; Sarah Amelia, born May 30, 1869; Jesse, born October 15, 1871; Edgar Allen, born November 6, 1873; Henry Laurens, born August 1, 1876; Eleanor Lorencie, born January 2, 1880. During the Civil War Eber Dimmick, father of the above children, enlisted in Company D, Thirtieth Regiment Pennsylvania Militia, as a second lieutenant, and was honorably discharged and mustered out, June 15, 1863.

(VIII) George Beck Dimmick, eldest son of Eber (2) and Eleanor Mary



(Beck) Dimmick, was born at Clarks Green (then Luzerne county), Pennsylvania, August 10, 1862. His childhood was spent in various Pennsylvania towns in which his father resided, and his education was obtained in the public schools. About 1877 the family moved to a large plantation in Virginia, where they resided until the autumn of 1879, then returned to Pennsylvania, locating in Scranton. In December, 1887, George B. Dimmick entered the employ of the First National Bank of Scranton, has passed through various promotions, and is now (1913) teller. He is a member of the Free and Accepted Masons, a Republican in politics, and a man of both ability and character.

Mr. Dimmick married, September 15, 1903, Elizabeth Fuller, daughter of Colonel Frederick L. Hitchcock, of Scranton. Children: Caroline Eleanor, born August 28, 1904; George Beck (2), born March 1, 1906; Elizabeth Kingsbury, born August 6, 1913.

---

### EDWARD JAMES CONNERTON

A native of the city of Scranton, son of a father who was for thirty-five years identified with the steel industry in this city, and himself a product of the educational institutions thereof, Edward J. Connerton has been connected with Sauquoitt Silk Mills, of Scranton, throughout his entire business career, and at the present time serves that organization in the capacity of cashier.

His father, Edward Connerton, was born in county Sligo, Ireland, in 1845, and when twenty-three years of age left that land and came to the United States, immediately upon his arrival settling in Scranton where he was employed in the Scranton Steel Works until his retirement in 1903. He married Ann, daughter of James and Elizabeth (Larkin) Morrow, of Dublin, Ireland, and had children: Patrick, deceased; Sarah, married a Mr. Farrell and lives in Scranton, Pennsylvania; Michael, engaged in steel manufacturing in Buffalo, New York; Edward James, of whom further; Anna J., entered educational fields and is now principal of Scranton public school No. 37. Edward Connerton was the second of his line to come to the United States, his father, Bartholomew Connerton, a native of Ireland, having come thither in 1870, dying in Scranton, Pennsylvania, in 1885. He was the father of Michael and Edward, the latter of previous mention.

Edward James Connerton, son of Edward and Ann (Morrow) Connerton, was born in Scranton, Lackawanna county, Pennsylvania, May 31, 1876. He completed the course in the public schools, graduating from the high school in the class of 1891, immediately entering Wood's Business College, from which he received a diploma in the following year. A position as bookkeeper being offered him in the Sauquoitt Silk Mills, he accepted the same and has since been associated with that concern, in 1899 being promoted to the office of cashier, and as such now serves the company. His scrupulously careful habits and his high sense of personal integrity make him a trusted employee, and the fidelity of his services have been a complete vindication of the judgment exercised in his choice. He is competent in the discharge of his duties, loyal to his employers, an energetic worker for the welfare of the company, and the lists of those connected with the Sauquoitt Silk Mills contain no name that embodies greater capacity or willingness for service than that of Mr. Connerton. A Democrat in politics, he is a member of St. Mary's Club of Dunmore and the Knights of Columbus. Mr. Connerton married, June 4, 1913, Ella G. Connell, of Scranton, Pennsylvania.

## ARTHUR W. CORNELL

Identified with Scranton's business interests since 1908, Arthur W. Cornell has, since 1911, been known as the secretary of the Nicholson Lumber Company, one of the thriving and substantial concerns of the city. His father, Jerome B. Cornell, was born, in Lemon township, Wyoming county, Pennsylvania, July 15, 1855. His grandfather, George, was a native of Lemon, Pennsylvania, and there married a Miss Sterling, and their children were: Jerome B., of whom further, Calvin, Sterling, and Lou, all deceased. Jerome B. Cornell was a farmer and for fifteen years the well known driver of a stage between Nicholson and Tunkhannock. In October, 1906, he came to Scranton, and there lived retired until his death, which occurred November 14, 1912. He married Eunice, daughter of Francis Patterson, her father an early settler of Lemon township, Wyoming county, who died aged ninety-two years. Jerome B. and Eunice (Patterson) Cornell were the parents of the following children: 1. Frank C., a railroad employee at Allentown, Pennsylvania, married Stella Welch and is the father of: Rhoda, Jerome, Arthur, Bernard, and Ellis. 2. Harlan P., a farmer of Lemon township, Wyoming county, married Alice Hunt. They have one daughter, Eunice. 3. Emery A., a clerk in the employ of the Delaware, Lackawanna & Western Railroad, married Helen Gilpin. 4. Benjamin H., a locomotive engineer. 5. Arthur W., of whom further. 6. Leo M., married Harriet Reynolds, and resides in Scranton. They have one son, Robert. 7. Lou Emma, a teacher in the New York public schools. 8. Niles J., deceased. 9. Bernard James, deceased. 10. Ruth, deceased.

Arthur W. Cornell, son of Jerome B. and Eunice (Patterson) Cornell, was born in Nicholson, Wyoming county, Pennsylvania, April 16, 1889. After spending eleven years in the public schools of Nicholson, he became a student in the Scranton Business College. His studies completed, for the following fifteen months he was employed by the American Locomotive Works, then came to Scranton passing the four following months in the employ of the Scranton Stove Works. On August 6, 1906 he became identified with the Nicholson Lumber Company, and upon the incorporation of this concern in 1911, with William W. LeRoy as president, Mr. Cornell became a member of the firm, holding the office of secretary. This is the position he has since held in the company's organization, its affairs at the present time being in a most prosperous and flourishing condition, due to the careful and conservative management of those at its head and responsible for its successful continuance.

Mr. Cornell's political belief is Republican, and he is a member of the Fraternal Order of Eagles.

---

 DUDLEY RAY ATHERTON

Atherton is a name early connected with the history of Luzerne county, Pennsylvania, particularly in that part now Lackawanna county. The family was a large and important one, having many branches and is yet numerous and prominent in the state.

Dudley R. Atherton was born in South Montrose, Pennsylvania, December 3, 1878, son of Bicknell B. and grandson of Jonathan Atherton. Bicknell B. Atherton was born in Hyde Park, Scranton, May 30, 1842. He was connected with the Delaware and Hudson Coal Company all his active years, and is a veteran of the Civil War. He enlisted in Company H, One Hundred and Forty-first Regiment Pennsylvania Infantry, as a private. He rose to the rank of first lieutenant and after a service of three and a half years was honorably discharged. He is a member of Griffin Post, Grand Army of the





*P. F. Carlucci*

Republic. He married Amanda Safford, of Lathrop, Pennsylvania, and has children: Dudley R., mentioned further; Grace, married J. E. Adamson Jr.; Fred B.

Dudley Ray Atherton was educated in the public schools and in 1895 began business life as bookkeeper for the Providence Gas and Water Company, continuing until May 1, 1898, when he resigned his position. He then entered the employ of the Third National Bank of Scranton as bookkeeper, remaining with that bank until 1905, advancing and for the last three years being credit clerk. In 1905 he became associated with the brokerage firm of Hollingshead and Campbell of New York City, dealers in commercial paper. He remained in the employ of the latter firm until July 1, 1908, when he was appointed to his present position, cashier of the North Scranton Bank. His years of experience have given him a knowledge and confidence in his own powers of judgment, and in each position he has filled, it will be noted, he has advanced to one of greater responsibility. He is well regarded in business and banking circles and is held in high esteem by his many friends. He is also secretary and treasurer of Group 3, Pennsylvania Bankers Association. He was formerly trustee and treasurer of the Providence Presbyterian Church, but is now connected in membership with the Green Ridge Presbyterian.

Mr. Atherton married, April 21, 1906, Annie, daughter of Edwin F. and Barbara Miscally, of Charleston, South Carolina; child: Dudley Ray (2), born July 22, 1908.

---

#### PETER FELIX CARLUCCI, M. D.

Highly educated for the medical profession, trained by hospital service and six years of general practice, Dr. Peter Felix Carlucci, one of the younger of Scranton's medical fraternity, holds high position and is rapidly rising to still greater honors in his profession. He is of Italian birth and parentage, Italy having been the home of the previous generations of his family. His grandfather was John Angelo Carlucci, a stone-cutter, who passed his entire life in Italy. His children: Mary, still living in Italy at an advanced age; Vincenzo, deceased; Antonetta, lives in South America; Carlo, of whom further; Peter, a resident of New York City.

Carlo Carlucci, son of John Angelo Carlucci, was born in Italy in 1832, removed to Scranton 1888, died there in May, 1909. He became a contracting builder and so continued until a few years before his death. He married Grace, daughter of Frank Napoliello, and had children: Frank, a contractor of Scranton; Mary, married Joseph Calabrese, and resides in Scranton; Nicholas, a contractor of Scranton; Rose, married J. Cassesse, and lived in Scranton until his death, December, 1913; Pasqualena, deceased; John, a sculptor; Antonetta, a resident of Detroit, Michigan; Ermenia, married Mr. Chevalier, Italian Consul at Detroit, Michigan; Peter Felix, of whom further.

Dr. Peter Felix Carlucci, son of Carlo and Grace (Napoliello) Carlucci, was born at Santomenna, province of Salerno, Italy, January 15, 1883, and when five years old was brought to the United States, attending parochial schools for six years, then entering the public schools of Scranton, and was graduated from the high school in the class of 1903. Strongly attracted by the medical profession, he entered the medical department of the University of Pennsylvania to prepare therefor, being awarded his M. D. in 1907. For one year after his graduation he was connected with St. Francis Hospital, in Pittsburgh, then came to Scranton, and in July, 1908, established as a practitioner in that city. During his connection with the medical profession of Scranton he has received several appointments significant of the trust and confidence placed

in him as a physician, and is examiner for the New England Mutual Life Insurance Company, medical inspector of public schools of the city, member of the medical staff of the West Side Hospital, and on January 5, 1914, was appointed police surgeon for the city of Scranton, all testimonials to his eminence in surgery and medicine. He is a member of the County, State and American Medical associations, the West Side Republican Club, and Christopher Columbus Lodge, No. 1160, I. O. O. F. His religion is the Roman Catholic, and he is a communicant of St. Lucia Catholic Church.

Dr. Carlucci's career may only be termed brilliant, for his attainments would well grace one who had grown old in the practice of medicine. His opportunities are practically boundless and the most conservative judgment would counsel that his attainments will press hard against their limits.

### JOHN ROE ATHERTON

The residence of this branch of the Atherton family in Pennsylvania dates from 1835, although it is one of the oldest of New England family names and one long settled in Massachusetts as colony and state. Through his mother, Abbie Foster (Roe) Atherton, daughter of John F. Roe, of a New York family, he traces through colonial forbears to the "Mayflower," she being eligible in maternal and paternal lines to membership in the following patriotic and colonial societies: General Society of Colonial Wars, the Daughters of the Revolution and the American Revolution, the Society of Mayflower Descendants, and that of Descendants of Colonial Governors, and the National Society of Colonial Dames.

Born at Bernardston, Massachusetts, July 30, 1834, Henry F. Atherton was brought by his parents to the Wyoming Valley in 1835, when only one year old, the long journey being made by team and in a covered wagon. In 1838 the family moved to Hyde Park. After finishing his education Mr. Atherton engaged in business in Montrose, and Honesdale where he remained until March, 1864, when he came to Scranton as accountant and assistant paymaster with the Delaware & Hudson Canal Company. In 1869 he was made paymaster of the company and this position he filled with greatest efficiency until his death in 1899. He married Abbie Foster, daughter of John F. Roe, of Honesdale, and to them were born the following children: Caroline F., Annie R., John Roe, of further mention; Thomas S., assistant paymaster of the Delaware & Hudson Company, and Henry F. Jr., treasurer of the United Traction Lines, in Albany, New York.

John Roe Atherton was born in Providence, Pennsylvania, January 14, 1872. He was educated in the public schools of Scranton and under private instruction, beginning his long term of service with the Delaware & Hudson Company in 1889 as clerk in the office of his father, then paymaster of the road. He so won the regard of his superiors in office that he was promoted to the position of assistant paymaster, and continued as such until the death of his father, April 3, 1899, when he was elected to the office of paymaster of the road. This position he most ably and honorably filled for a quarter of a century, and in addition has been a leading spirit in the management of the North Scranton Bank, since he first became interested in its organization, in 1901. He was chosen a member of the first board of directors, was for several years vice-president, and in 1910 became its honored president. His long years of training in financial operations as paymaster of a great corporation eminently fitted him for the responsible position he now holds, while his years of attentive service on the board of bank directors gave him the special knowledge of the laws governing banks and banking. Hardly yet in the prime

of his manhood, Mr. Atherton has in every field of endeavor entered proved his sterling ability and life holds for him only promise of a still more successful future. He is a member of the Scranton Club, Country Club, and Presbyterian church.

---

#### ERNEST W. DOLPH

Coming to Pennsylvania from New York, the family of which Ernest W. Dolph is a member is one of French origin, the present form and spelling being a contraction of the name de Wolf. Isaac Dolph, a native of New York state, was the Pennsylvania founder of the line, settling at Dunmore and becoming the owner of a vast tract of land including a section upon which the present borough of Dunmore is located and extending well toward Providence. He was the first justice of the peace. Isaac Dolph married a Miss Griffin and had children: William, a soldier of the Union army during the Civil War, serving throughout the entire four years of the conflict and participating in numerous of the most important battles of the war, his death occurring soon after its close; Hiram, deceased, lived at Lake Winola, married and had two daughters, one married W. J. Northrop, of Scranton; Samuel, of whom further.

(II) Samuel Dolph, son of Isaac and ——— (Griffin) Dolph, was born in Scranton, Pennsylvania, in 1829, died in 1905. He was for several years engaged in lumber dealings in his native city and was afterward in charge of the lumber department of the Lackawanna Iron and Coal Company. In 1865 he caused a house to be erected on Clay avenue, near Linden street, the first structure to be reared on Clay avenue, having previously dwelt opposite the present station of the Laurel Line Railroad and on the site of the Spruks Brothers Lumber yard. He married Mindwell, daughter of Daniel Ward, her father being one of the early settlers of this locality, having moved here from New York state. Children: Ella, married Wickham Jackson, of Utica, New York, and has Herbert, Eva, Lulu, Frank; Ada, married E. O. Voris, of Northumberland county, Pennsylvania, and has Roy, Anna, Charlotte, Marjory, E. Oakley; Richard, died aged fifteen years; Berlingame, died in infancy, Charlotte, married A. C. Angel, of New York City, and has May Belle and Amy; Mary, married Marshall E. Everett, of Scranton, and has Adeline and Lois; Ernest W., of whom further.

(III) Ernest W. Dolph, son of Samuel and Mindwell (Ward) Dolph, was born in Scranton, Pennsylvania, June 28, 1873. He was a student in the public schools of Scranton until he was seventeen years of age, in the fall of 1890 becoming librarian of the Young Men's Christian Association, the building of that organization being then located on the present site of the Peli Theatre. In December, 1891, Mr. Dolph became messenger for the Traders' National Bank, then located on Lackawanna avenue, and has been in the service of that institution since that time, being now employed as assistant cashier, to which office he was raised in 1902. For nearly a quarter of a century this bank has received his devoted service, during which time he has gained the trusting confidence of his superiors in office and has become known as an employee of the Traders' National than whom none is more conversant with the intricate details of its business. Mr. Dolph is a Republican in political conviction, and a member of the First Presbyterian Church of Scranton, Pennsylvania. He married Myrtle Bolton, daughter of Jesse and Augusta Thankful (Coon) Hughes. Mr. and Mrs. Hughes have children: Harry J., James Percy, Myrtle Bolton, of previous mention. Child of Ernest W. and Myrtle Bolton (Hughes) Dolph: Kenneth Wilson, born April 9, 1898.

## WALTER LIDDELL HILL

Walter Liddell Hill was born in Lewisburg, Pennsylvania, August 7, 1875. He was admitted to practice law in North Carolina in 1898, but returned to Pennsylvania and settled in Scranton where he was admitted to practice in 1900, and where he has resided ever since. He is now a member of the firm of Warren, Knapp, O'Malley & Hill.

---

M. J. MURPHY

The city of Scranton has many representative citizens and the foremost of these is M. J. Murphy, who was elected, August 11, 1914, one of the three Class A directors of the Philadelphia Federal Reserve Bank.

Mr. Murphy was born on a farm near Towanda, Bradford county, Pennsylvania, June 18, 1868. After proper preparatory study at the district schools, he entered the Susquehanna Collegiate Institute at Towanda, from which he was graduated in the class of 1888. He became a teacher, for which position he was well qualified, and in 1891 was appointed principal in the schools of Ulster, Bradford county, Pennsylvania. In the spring of 1891 he accepted a position as messenger and bookkeeper in the First National Bank of Towanda, serving for a period of two years, and then accepted the position of teller in the Citizens National Bank of Towanda, where he served until 1899. At that time the Athens National Bank, of Athens, was organized, and Mr. Murphy was tendered the cashiership, which position he accepted, and notwithstanding the fact that the new bank had well established competition, Mr. Murphy succeeded in raising it to such a standard that he was tendered the cashiership of the Keystone Bank of Scranton, which was organized at that time. In April, 1907, Mr. Murphy was tendered the cashiership of the Traders' National Bank of Scranton, whose deposits at that time were less than two million dollars, and they now average about three and a half millions. The directors of this bank ascribe this very satisfactory result, in a great measure, to the personal efforts of Mr. Murphy, and freely give him credit for it. During the years of his connection with banking institutions, he has been active in the interest of the same in every direction and in every class. He has served as chairman of the local Group of the Pennsylvania Bankers' Association, and has performed effective work in the legal and educational phases.

Scranton's position as the financial metropolis of the anthracite coal region and the entire northeastern section of Pennsylvania was never more clearly indicated than when two of her citizens, W. H. Peck and M. J. Murphy, were elected Class A directors of the Philadelphia Federal Reserve Bank. So far as known Scranton now occupies the unique position of being the only city in the country, outside of the headquarters of a regional bank, to produce from its banks two Class A directors.

---

CYRUS O. SUTTON

Cyrus O. Sutton is one of the comparatively few residents of Scranton whose family boasts of an American ancestry of worthy length, the Suttons being of English descent and early settlers of Connecticut, whence came George Sutton, who settled in Bradford county, on Towanda creek, and was drowned in its waters a few years later. He was the father of Silas S. Sutton, who purchased a tract of land in Newton township and conducted thereon farming operations, his son, Peter, and grandson, Cyrus O., both owning that as their birth-place. He married Harriett Gardner. Children of Silas S. and Har-



riet Sutton: 1. Peter, of whom further. 2. Lydia, married George Beisicker; they were the parents of a daughter, Anna, who married Davis Nafus. 3. Eliza, married William Callender; she is still living, the mother of Hattie. 4. Ira G., deceased; was a soldier of the Civil War; married Elmira Hetteshammer; children: Bruce S., Sarah, Victor. 5. Ann S., married John Shelley; their son, Richard, is an employee of the International Correspondence Schools, of Scranton.

Peter Sutton was born in Newton township, Lackawanna county, Pennsylvania, in 1831. He attended the public schools, and has followed agriculture throughout his entire life, making the raising of fine grades of fruit and vegetables his especial field of endeavor. He is still living, aged eighty-three years. He married Caroline, daughter of John and Catherine Bumgardner. Children: 1. Cyrus O., of whom further. 2. Ida, married Joseph E. Marcy. 3. Harry John, auditor of the Connell Anthracite Mining Company; married Minnie, daughter of James Sutton, of West Pittston, Pennsylvania.

Cyrus O. Sutton was born in Newton township, Lackawanna county, Pennsylvania, October 10, 1858. He obtained his early education in the public schools, later supplementing this with a course at Bloomsburg State Normal School. For one year thereafter he attended Union Seminary, discontinuing his studies at that institution in 1878 to enroll as a student in the Bryant and Stratton Commercial College, Utica, New York, the following year becoming a teacher in the Institution. He spent the next three years as a teacher in Newark, New Jersey. His next position was as a teacher in Johnstown, and with his wife he was a resident of that city when the breaking of the Cone-maugh dam brought upon the inhabitants of that place the flood that made thousands homeless and claimed as many more in the terrible toll of death. After the disaster, from which he and his wife were saved, he made his home in Scranton and has since been a resident of that city. His first business venture in Scranton was in partnership with Augustus M. Atherton, the enterprise being a general store. So successful was this business that soon after they opened a branch store in Olyphant. About the end of the 1902 coal strike the Olyphant store was destroyed by fire and Mr. Sutton retired from the business. On April 20, 1903, he entered the employ of W. L. Connell as bookkeeper and paymaster for the Connell Anthracite Mining Company, a position he held for eight years. Since May, 1911, he has been engaged in the capacity of auditor for the following companies, in all of which Mr. Connell holds interests: Connell Anthracite Mining Company, Lackawanna Coal and Lumber Company, Paint Creek Collieries Company, Mucklow Supply Company, Coal Lands Securities Company and Highland Lumber Company. He is also treasurer of the Bernice Stone Company.

Mr. Sutton married, October 26, 1886, Ida May, daughter of Thomas L. and Mary Jane (Millard) Hughes. He is a member of Providence Conclave, Independent Order of Heptasophs, and in politics supports the Republican party. His religious belief is Methodist and he is a member of the Asbury Methodist Episcopal Church, holding a position upon its official board.

---

#### EVAN S. JONES JR.

There is little in the career of Evan S. Jones but is worthy of imitation by the young of to-day. Born in far away England, and early bred to habits of industry and thrift, Mr. Jones has seized every opportunity for advancement offered by his adopted country and stands to-day, at the head of one of Scranton's successful industrial corporations, The Washburn Williams Company, leading lumber dealers and contractors.

Evan S. Jones Sr. was born in 1838, in Brecon, Wales, and there grew to manhood. After a residence in England, he and his brother, Thomas H., came to the United States in 1869, locating in Scranton, where as Jones Brothers they established the first cut stone business in the city. They were both practical stone cutters and continued in successful business until 1888, when Evan S. retired. He was a member of Hyde Park Lodge, No. 339, F. and A. M., and a man of high standing in his community.

He married (first) Deborah Powell, January 25, 1859, in Lanely, Wales, Evan S. Jr. being the only surviving child of that marriage. On December 8, 1875, in the city of Scranton, he married (second) Catherine Harrison, born in September, 1838, in the city of Carbondale, and had two sons: William G., of Hutchinson, Kansas, and Robert D., of Scranton. The family in Scranton were members of the Simpson Methodist Episcopal Church.

Evan S. Jones Jr. was born in Liverpool, England, July 17, 1862, and at the age of seven years was brought to this country by his parents. He was educated in the public schools and Wyoming Seminary, whence he was graduated class of 1886. He began business life as an apprentice with his honored father, continuing until he was master of the stone cutter's trade. Later he abandoned his trade and became bookkeeper for John Benore & Company, continuing with that firm for twelve years. He then became a member of The Washburn Williams Company, which was incorporated in 1898 with Frank W. Washburn, president, William R. Williams, treasurer, Evan S. Jones, secretary and general manager. This company began business by purchasing the lumber yard and business of Washburn & Zearfoss, established in Scranton about the year 1880. The business in 1898 was a small one but with the infusion of the Williams-Jones blood a change was at once apparent. New avenues of trade were opened, branch yards established, a continuous period of prosperity following the well timed energetic activities of the company. The yards, mill and office of The Washburn Williams Company are located at Nos. 119-131 Meridian avenue, where a lumber, contracting and manufacturing business, amounting to one-half million dollars annually, is transacted. The manufacturing of interior finish, show cases and store fixtures, is a specialty of their business, while in the lumber department all kinds of builders' lumber and fancy veneers are carried in plentiful supply. Glass of the highest grades, domestic and imported, in an endless variety, now used in building and decorating, is carried in quantity. The working force employed by the company numbers about one hundred and fifty people, their product going to all parts of the Middle and Eastern States. A reorganization of the executive staff was effected, Mr. Jones being elected president and general manager; William R. Williams, treasurer; Robert D. Jones, secretary. While all these gentlemen are business men of high standing, the success of the company has been rendered doubly sure through the wise management of Evan S. Jones, the general manager since incorporation and present executive head of the company. He has employed every approved modern method and mechanical device in the manufacturing department, while in the selling and operating departments efficiency and true economy are everywhere apparent. Now in the prime of life, the ambition and enthusiasm of Mr. Jones carry him along at full speed and greater distinction in the business world surely awaits him. Already he has been called to other responsibilities of importance, being the present honored vice-president of the Electric City Bank of Scranton.

Mr. Jones is prominent in the Masonic Order, belonging to Hyde Park Lodge, Free and Accepted Masons; Nobles of the Mystic Shrine; Keystone Lodge of Perfection, fourteenth degree; Keystone Council, Princes of Jerusalem, sixteenth degree; Keystone Chapter of Rose Croix, eighteenth degree;

Keystone Consistory, Sovereign Princes of the Royal Secret, thirty-second degree; Ancient Accepted Scottish Rite, Northern Jurisdiction United States of America.

Evan S. Jones, married, August 11, 1890, Myra, daughter of Clark Harrison, of Scranton. His two sons: Warren H. and Marshall C., are both associated with their father in business.

---

#### FLOYD D. BEEMER

Four generations of Beemers have been residents of what is now Scranton, the pioneer coming earlier than the men who first gave Slocum's Hollow its importance. The first saw mill in the section was built, owned and operated by Henry Beemer, who came from New Jersey to Slocum's Hollow in 1819, and for many years carried on farming and lumbering. He was a son of John Beemer, of New Jersey, a soldier of the Revolution. Henry Beemer was an ardent Whig and his house was the rallying point for those of that party who came in later. He had married and had ten children.

(II) Elias Beemer, son of Henry Beemer, was born in Beemersville, New Jersey, in 1806. He came to what is now Scranton with his father in 1819, and became a successful farmer. He married Phoebe Allbright and had issue: Allen, a veteran of the Civil War, a member of the state Republican committee, later settling in the state of Nebraska; Jennie, married O. D. Hollister; George, of further mention; Horace D., now a banker of the state of Wyoming; Ella, married W. H. Hollister; Samuel and Oakley, both merchants.

(III) George Beemer, son of Elias and Phoebe (Allbright) Beemer, was born in Luzerne, now Lackawanna county, Pennsylvania, April 14, 1848, and is now superintendent of Hillside park. His life has covered the period of Scranton's entire existence as a municipality, and in the growth and development of the city he has had a part. He was educated in public schools and Madison Academy, his earlier life being spent on the farm. In 1878 he gave up farming to accept an appointment as steward of the Lake View poor district, continuing until 1883, when he resigned, having been appointed to his present position, superintendent of Hillside. He is a prominent member of the Masonic Order; past master of Waverly Lodge, No. 301, F. and A. M., and a thirty-second degree Mason of the Scottish Rite. He is also a past noble grand of the Independent Order of Odd Fellows and a Knight of Malta. He married, in 1876, Jennie Young, of Ulster county, New York; children: Horace, born in 1878, died 1879; Floyd D.

(IV) Floyd D. Beemer, youngest and only living son of George and Jennie (Young) Beemer, was born in Newton township, Lackawanna county, Pennsylvania, August 5, 1888. His early and preparatory education was obtained in the public schools, Keystone and Mercersburg academies. He next entered Bucknell University, whence he was graduated class of 1910. He began business life as a lumber dealer at Clarks Summit, Pennsylvania, continuing until January 1, 1911, when he became associated with the Providence Bank, Scranton, as clerk. He continued as such until March 1, 1913, when he was appointed cashier, which responsible position he now holds. Although a young man, Mr. Beemer is highly regarded in financial circles, has fully gratified the wisdom of his appointment, and with a career but fairly begun, future biographers will surely have higher and greater deeds to chronicle concerning him. He is a thirty-second degree Mason and Shriner.

## HON. WILLIAM CONNELL

It is characteristic of our twentieth century era that no matter how indisputable a statement, or how clear a result, the desire for the reason is continually uppermost in the minds of every one. To this quality of our people we owe our extremely intricate knowledge of chemical and physical properties, since in all lines of scientific research nothing is accepted as a fact until all the causes contributing to the effect are known, and an invariable rule established. Nor do we confine our inquisitiveness and love of fundamentals to our professions and sciences, but in considering the lives of our most prominent and important citizens, we closely scan the generations that have gone before to find here and there evidences of certain traits that characterize the present generation.

To define the causes that have participated in making the life of William Connell one of such glorious usefulness, one must, after searching the pages of history, conclude that the success and honor crowning his years of labor are due, more than to anything else, to splendidly balanced intellect and personality, the outgrowth of the conditions in which he was placed and the adversities with which he had to contend. But, lest we seem to scorn heredity and to ignore ancestry, it must be admitted that many of his personal traits are shared in common with other descendants of the races from which he sprang. From his Scotch forefathers he inherited his habits of economy and frugality in the days when every dollar was needed, and his calm and clear foresight, while from his warmer blooded Irish forbears came his quick and friendly sympathy, and charming geniality, and to the strain of French blood in his veins he undoubtedly owes his sensitive emotion, so easily touched by misfortune, yet so tempered by his less impulsive Scotch blood that in his various charities there was no sentimental and indiscriminate giving, but only relief and aid for the really worthy. Yet it is indisputable that the very nature of the man himself so entwined and welded his different characteristics that to his closest and most familiar friends no strain appeared more strong than another, all uniting in William Connell, than whom there was no citizen of Scranton held in more sincere respect and regard, or none whose absence from the place he had filled so long could cause more genuine regret and sorrow.

James Connell, father of William Connell, was born in Aberdeenshire, Scotland, and there lived until the death of his father. His mother's second husband being a person entirely uncongenial to him, he decided to leave a home from which, for him, most of the happiness and joy had departed, and to seek his fortunes under different skies. He shipped as cabin boy upon an English merchant vessel, and sailed for many years, visiting nearly every foreign country on the seacoast and traversing every sea. At length he settled in Nova Scotia, where he entered the employ of a farmer, and where he married. In 1844 he and his wife, with their family, moved to Luzerne county, Pennsylvania, and late in life made Scranton their home, in which city their deaths occurred.

From the foregoing paragraph it is plain that William Connell was, at birth, neither fed with a silver spoon, nor rocked in the lap of luxury. From his father he received nothing but the example of an honest and upright character. He was placed at the foot of the ladder of achievement, blessed with two strong hands and a clean and healthy mind. A glance of the dizzy heights above did not impress him with the futility of an attempt to ascend, but nerved him to place his foot upon the bottom rung and begin the climb which he never ceased to do until, reaching upward for the next step, he





*J. M. Cornell*



*Archieonni*





found that he occupied the topmost position, that from below had seemed so unattainable.

William Connell was born at Cape Breton, Nova Scotia, September 10, 1827, son of James and Susan (Melville) Connell. Nearly all of his early life, after his school-days, was spent in the employ of companies engaged in mining of coal, one of the natural resources of the section which seemed practically inexhaustible. Throughout his youth, as indeed in later life, he was an indefatigable worker, bending his every energy to the task at hand, and brightening the most commonplace of occupations by the active manner in which it was dispatched. Imbued with the desire for better things and realizing that the opportunity for the gratification of such desire lay only in improving his financial condition, he lived frugally and saved a large part of his weekly wage. The first material advancement came to him in 1856, when he was placed in charge of a mine at Scranton, owned by the Susquehanna and Wyoming Valley Railroad and Coal Company. His nominal position was as mine foreman, but as his exceptional ability became more and more apparent, added details of the business were placed upon his shoulders until, in 1872, when the charter of the corporation expired, Mr. Connell had entire supervision of the operation of the mine and was the trusted advisor of the directors in all matters relating to the practical side of the business. Although he did not realize it at the time, Mr. Connell's change of fortune began with his entrance into the employ of this company. While many times during his continuation in its service he was offered salaries greatly in advance of the four thousand dollars he was then receiving, to go with other companies, he steadfastly refused them all. Asked for his reasons for so doing, he replied, "In the light of subsequent development, I am inclined to attribute it to Providence. At the time, my reasons were that my employers, the Susquehanna and Wyoming Valley Company had always treated me fairly, that I had faith in their promises of continued fair treatment, and that I then foresaw and desired to participate in the marvelous growth which has since come to the city of Scranton." At the expiration of the company's charter in 1872 he, with his savings, purchased the property. For the greater part of the purchase price he was compelled to give his note, which was willingly accepted by the directors of the former company, an eloquent tribute to the years of service in their employ. Their confidence was entirely justified, inasmuch as, within a few years, he was enabled to pay off his entire debt and had placed moreover the firm of William Connell & Company upon a solid and substantial working basis.

The first business transaction in which Mr. Connell ever engaged whereby he received recompense not in the form of wages or interest was in the case of the Nay Aug Colliery. Just previous to the Civil War a company composed of eight of Scranton's business men, of which Mr. Connell was one, purchased the Nay Aug Colliery for a sum amounting to about fifty thousand dollars. Mr. Connell's share was his savings of the years before. The wisdom of the venture was soon apparent, for with the outbreak of the war the price of coal soared as did likewise the price of many other commodities. A syndicate of capitalists with funds to enlarge the colliery and largely increase its earning capacity offered the company a sum greatly in advance of the original price paid for the colliery, a proposition which was accepted. Mr. Connell's share of the profits from this deal amounted to thirteen thousand dollars. This formed the nucleus about which he constructed his subsequently generous fortune and was the first of the many wise and carefully planned investments, of which he made so many in later years.

To give an exhaustive account of Mr. Connell's varied business activities

would carry one into many of the large concerns of Scranton. In 1872 he assisted in the organization of the Third National Bank of Scranton, which he first served as director and of which he was chosen president in 1879, which office he held for twenty-five consecutive years, and in 1887 he was active in the formation of the Scranton Safe Deposit and Trust Company capitalized at two hundred and fifty thousand dollars, of which he became director. In 1890 he organized the Connell Coal Company, purchasing and leasing large holdings of coal land in Lackawanna, Old Forge and Ransom township. The daily capacity of the two model breakers erected upon this tract was three thousand tons. Besides his connection with these organizations, Mr. Connell was president of the Lackawanna Knitting Mills Company; president of the Scranton Button Manufacturing Company; president of the Weston Mill Company and president of the Meadowbrook Land Company. His name also appeared upon the directorates of the Lackawanna Iron and Steel Company; Dickson Manufacturing Company; Clark & Snover Company; Scranton Bolt and Nut Company; Scranton Packing Company; Scranton Forging Company; Lackawanna Lumber Company; Consumers Ice Company and the Scranton Tribune. In the many institutions in which he was not publicly interested, being only a stockholder, his advice and counsel was frequently sought and as frequently accepted, his wide experience and recognized superior financial sense giving him great prestige even among the ablest of Scranton's financiers. In the countless business transactions he has backed and in the long list of companies where his name has appeared in a responsible position, there is not to be found a single instance in which the results did not live up to the expectations and no name in Scranton's financial history is more free from contamination by "wild-cat" schemes and from the curse of cheated investors, than that of William Connell. His figure stood out clear and strong, no matter what the difficulty or how frenzied the gathering around about him, inspiring in others the thought that here, at least, was one to whom the lure of gold and the greed of gain could make no appeal and to whom they might with safety entrust their all.

With his prominence in Scranton and in the northeastern part of the commonwealth of Pennsylvania, it was almost impossible that he should not be led into the public service. Although a long while before accepting office, he had been a constant advisor and confidant of the leaders of the Republican party in his section and had, in large measure, dominated political affairs in the locality. His name as a candidate for public political preference was first presented in 1896, when in November he was elected to Congress. For three terms following he was returned to this august legislative assembly, ably representing his district and proving his worth among the best American statesmen. His popularity was shown by his large plurality in the election, eight thousand, four times as large as that accorded any previous candidate of the party in that district.

Still another phase of Mr. Connell's extremely versatile personality is shown in his deeply interested activity in the Methodist Episcopal church, his connection with that denomination being with the Elm Park congregation. The chimes in Elm Park Church: ten bells with names of Mr. Connell and wife, and two oldest children on large bell, and each of the other bells is named for each of the children; they are called the Connell Memorial Chimes, the best in the country, and invalids and others wrote him their appreciation; he gave them in 1894. Although the church was burned twice the chimes were not injured either time. As proof of his work in the church organization is the fact of his delegation to the Methodist Episcopal conference, held at Philadelphia in 1884, at which gathering he represented his

home church. In the educational institutions of the denomination he was also numbered as an enthusiastic supporter and sympathizer, as he was a trustee of Syracuse and Wesleyan universities, Drew Theological Seminary and Wyoming Seminary.

To his innermost circle of friends Mr. Connell was known as a close student, enjoying to the full an evening's communion with the best of classic and modern authors. Possessing a fine discriminating taste, he would have been a masterly scholar had the opportunity for higher education come to him early in life. From his literary likes he obtained much of the pleasurable relaxation that came to him in the course of an exceedingly busy life.

To the city of Scranton, Mr. Connell has left two lasting memorials of his name, one of the Connell Building, a stately office structure in the heart of the business section, the other, Connell Park, which will in the greater expansion of the city, certain to come, prove to be a valuable addition to the municipal property and a spot which will delight lovers of natural beauty.

But the real medium through which the name of William Connell will be preserved in the region to which he dedicated so much of his toil and talents is not the building or the park which bears his name, but in the high place accorded to social, financial and industrial Scranton among the other cities of the state. Much of the best and finest in Scranton's history has been the result of his patient and earnest labors in its behalf, his civic pride and his untiring zeal for the advancement of the city, the scene of his success-crowned struggle.

Mr. Connell married, January 2, 1852, Annie Lawrence, of Llewellyn, Schuylkill county, Pennsylvania, born August 4, 1835. To this union was born eleven children, of whom six are living: 1. Emma, born October 5, 1852, died in infancy. 2. Mattie, born April 25, 1854; married Samuel W. Edgar; died April 10, 1888. 3. James L., of whom further. 4. Mary E., born August 4, 1858; married Edward J. Dimmick; died June 15, 1891. 5. William A., born September 9, 1860, died November 21, 1899. 6. Jessie A., born July 18, 1862; married J. S. McAnulty. 7. Charles R., of whom further. 8. Alfred E., of whom further. 9. Annie A., born May 29, 1869; married C. W. Fulton. 10. Theodore E., born July 8, 1871, died June 15, 1903. 11. Ezra Hoyt, of whom further.

Mr. and Mrs. Connell, rising by prudence and thrift from poverty to affluence, were not forgetful of their early days and associations, but bore their prosperity with becoming gentleness and kindness. They were ever considerate and benevolent though to the last degree unostentatious. Few knew of the amount or character of their large benevolencies. The home life of Mr. and Mrs. Connell was ideal. Never were husband and wife more devoted and until her death, their home was a rendezvous for hosts of their admiring friends. On January 2, 1902, they celebrated their golden wedding, an occasion without ostentation, yet memorable for the multitude which included practically all the city, besides a host from other places, who came to present their congratulations. Mrs. Connell passed away June 24, 1902. Mr. Connell, March 21, 1909.

---

### JAMES L. CONNELL

James L. Connell, son of William Connell, was born at Crystal Ridge, Pennsylvania, April 17, 1856. He obtained his early education in the public schools of Minooka, whither his parents had moved when he was but a youth, also attending the Wyoming Seminary. When he was sixteen years of age his parents moved to Scranton and it was here he obtained his first employ-

ment in the wholesale grocery business of A. G. Gilmore, later engaging in the retail grocery business for two years with F. P. Price under the firm name of Price & Connell. Withdrawing from this partnership in 1877, Mr. Connell formed another with I. F. Megargel, and journeying to Des Moines, Iowa, established a tea, coffee and spice business. The following year they returned to Scranton and admitted Alexander Connell into the firm, changing the name to Megargel, Connell & Company, and engaging in wholesale grocery dealing until 1882, when upon the death of Alexander Connell, his interest was purchased by the other two partners, the firm continuing operations as Megargel & Connell. About 1899 Mr. Connell purchased his partner's interest and admitted William Connell to the firm, the name becoming J. L. Connell & Company. In 1902 their place of business was burned out and the business closed. Mr. Connell then devoted his entire time to his other business relations as vice-president of the Clark & Snover Company, as treasurer and director of the Cherry River Boom and Lumber Company, and as vice-president and director of the Third National Bank. He is also a director of the Richwood Store Company, the Hebard Cypress Company, the Hebardville Store Company, the Lackawanna Mills, Scranton Button Company and the Wyoming Shovel Works.

Mr. Connell is a member of the Masonic Order, belonging to Peter Williamson Lodge, Free and Accepted Masons; Lackawanna Chapter, Royal Arch Masons; Coeur de Lion Commandery, Knights Templar; Keystone Consistory, Sovereign Princes of the Royal Secret; and Irem Temple, Nobles of the Mystic Shrine. He also holds membership in the Scranton Club, the Country Club and the Waverly Club. With his wife he is a member of the Elm Park Methodist Episcopal Church, in which he is a trustee and a member of the official board. He married Leonora Pratt and has three children: Lawrence M., Carleton A., Mary Lucile.

---

#### CHARLES R. CONNELL

Charles R. Connell, son of William Connell, was born in Scranton, Pennsylvania, September 22, 1864. He obtained his education in the public and private schools of Scranton, completing his studies in Williston Seminary at Easthampton, Massachusetts. Since 1888 he has had complete charge of the Scranton Button Company, and the Lackawanna Mills, both of Scranton, positions he filled after preliminary instruction in the varied details of both processes. The Lackawanna mills is a corporation capitalized at five hundred thousand dollars, with an annual output valued at one million dollars, employs eight hundred persons and is one of the most prosperous of the city's industries; while the Scranton Button Company, capitalized at three hundred thousand dollars, employs five hundred persons, and is likewise numbered among the best paying of Scranton's many manufactories. In the responsible positions he fills, Mr. Connell shows much native ability, and so wisely governs the large number of employees under his direct supervision that strikes are unheard of. Various attractions, such as an annual excursion, are furnished for the enjoyment of the employees, while many devices for their comfort and safety are installed in both plants. Mr. Connell, besides his immediate business attachments, is a director of the Third National Bank, the South Side Bank of Scranton, and the United Button Company, of New York.

His fraternal connection is with the Masonic Order, in which society he belongs to Peter Williamson Lodge, Free and Accepted Masons; Lackawanna Chapter, Royal Arch Masons; Coeur de Lion Commandery, Knights Templar; Keystone Consistory, Sovereign Princes of the Royal Secret; and Irem Tem-

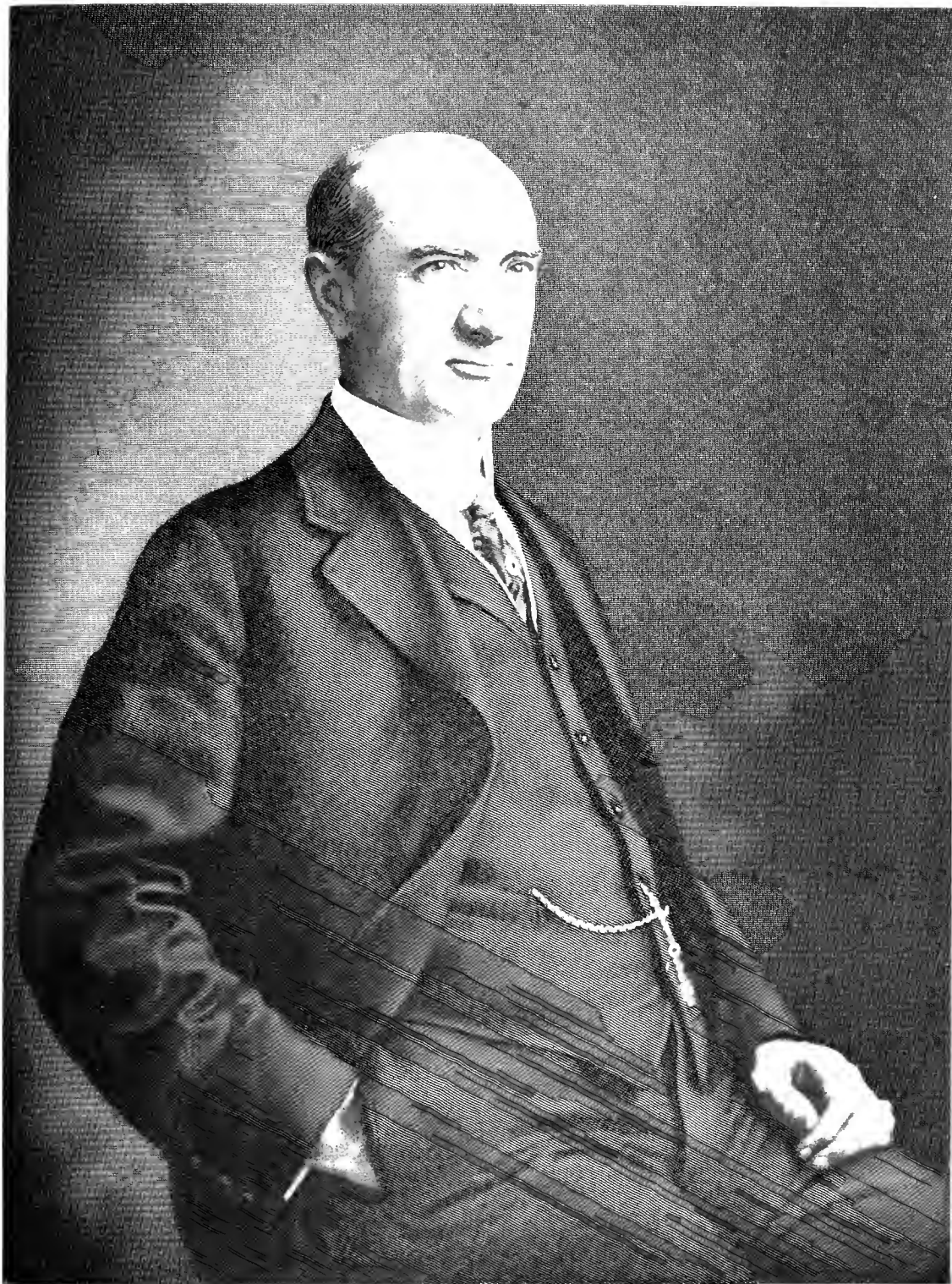

*Charles A. Connelley*







Alfred E. Arnold



ple, Ancient Order Nobles of the Mystic Shrine. He also belongs to the Benevolent and Protective Order of Elks, the Scranton Club, and the Manufacturers' Club of Philadelphia. He married Elizabeth, daughter of Charles Shafer, of Scranton, and has two children: Gladys S. and Bernard L.

---

#### ALFRED E. CONNELL

Alfred E. Connell, son of William Connell, was born in Scranton, Pennsylvania, June 24, 1867. He obtained his early education in the public schools of his native city and later attended the School of Lackawanna. His first position was held with the Hunt & Connell Company in the hardware business, a line in which he continued for five years, later entering the office of the Scranton Button Company, where he remained for several years. Until 1905 he was a store manager for a coal company, then entering the Meadow Brook Land Company, as general manager, an office he held from 1906 to 1909, in which latter year he became president. His other business interests are as director in the Scranton Button Company, the Lackawanna Mills and the Anthracite Trust Company. His public service is testified by his presence upon the board of trustees of the Pennsylvania Oral School for the Deaf, as well as his presidency of the Board of Charities and Humane Society of Lackawanna Company. In the Masonic Order he is past master of Peter Williamson Lodge, Free and Accepted Masons; Lackawanna Chapter, Royal Arch Masons; Scranton Council, Royal and Select Masters; past eminent commander of Coeur de Lion Commandery, Knights Templar; Irem Temple Nobles of the Mystic Shrine; Keystone Consistory, Sovereign Princes of the Royal Secret, Ancient Accepted Scottish Rite. He is also a member of the Scranton Club and the Country Club.

Mr. Connell married Jane, daughter of Job and Ann Harris, of Scranton; children: Edwin, a student at Yale University; Janet, attends the Emma Willard School at Troy, New York; Eleanor and Alfred H., Mr. Connell and his wife are members of the Elm Park Methodist Episcopal Church.

---

#### EZRA HOYT CONNELL

Youngest of the eleven children of William Connell, Ezra Hoyt is the only one born in the old historic Connell mansion on the corner of Clay avenue and Vine street. He was born May 9, 1873, and obtained his early education at the kindergarten then located in the old Jermyn residence on the corner of Jefferson avenue and Vine street. He later attended the School of the Lackawanna, the school of H. H. Merrill, and during the years 1888-90 was a student at Pennington Seminary, at Pennington, New Jersey. He entered Yale University in the fall of 1890, and in the spring of 1895 was thence graduated with the degree of A. B., having lost one year at the university through the typhoid epidemic. In 1895 he entered the law department of the University of Pennsylvania, whence he was graduated LL. B., class of 1898. Returning to Scranton he was admitted to the Lackawanna bar in 1899, and at once established in general practice with offices in the Connell Building. The same year he was admitted to the state Supreme Court and since then to all state and federal courts of the district, to all of which his practice extends. He is a member of the American, Pennsylvania State, and Lackawanna County Bar associations, and is a lawyer of ability, a man of high standing, and a good citizen. He is a member of the Elm Park Methodist Episcopal Church, and a Republican in politics.

Mr. Connell married, February 18, 1892, Elizabeth, daughter of Llewellyn Thomas, and resides at No. 436 Clay avenue.

## JAMES SHAFFER McANULTY

James Shaffer McAnulty, a well known business man of the city of Scranton, Pennsylvania, is the son of James and Anna (Shaffer) McAnulty. Both were born in Berks county, Pennsylvania, where they were married, and came to Scranton in 1854. Mr. McAnulty was in the employ of the Delaware, Lackawanna & Western Railroad Company, and was killed near Henryville, in 1856, on the first excursion given to the employes of this road. He was thirty-three years of age at the time. Mrs. McAnulty went to the McAnulty farm near Reading, where her mother-in-law lived, and there James Shaffer McAnulty was born, January 7, 1857, and when he was three months old his mother returned to Scranton, where she died in 1907 at the age of eighty-two years. She was a remarkable woman in many respects, and was a member of the First Methodist Episcopal Church, to which denomination both belonged.

James Shaffer McAnulty received a substantial education in public and private schools of Scranton, and in 1872 entered the employ of the Scranton Trust Company and Savings Bank as a clerk, and remained there until 1879 when the bank liquidated. In 1881 he entered into a partnership with L. J. Williams, under the firm name of Williams & McAnulty, dealers in stationery and wall papers, on Lackawanna avenue. At the end of one year they removed to Wyoming avenue, discontinued the stationery, and added carpets and furniture, and made this the largest store in the city. Mr. McAnulty is president of the Scranton Life Insurance Company, organized in 1907; secretary and treasurer of the Connell Anthracite Mining Company; president of the National Limestone Company; and a director in the Lackawanna Mills and other corporations. He was elected a member of the Scranton school board in 1903, and served a period of six years. He is a Republican in political opinion, and a member of the Scranton Club, Country Club, Art Club of Philadelphia, the Masonic Fraternity, having attained the thirty-second degree, and of Irem Temple, Ancient Arabic Order Nobles of the Mystic Shrine, and of the Independent Order of Odd Fellows.

Mr. McAnulty married, February 14, 1883, Jessie, daughter of William and Annie E. Connell, and they have one daughter, Anna, who married, April 11, 1912, Walter Phelps Stevens, and resides in Scranton.

---

 HON. JOHN R. FARR

Whenever the question of the fitness for public position of the Hon. John R. Farr has been left for the decision at the polls, the verdict has invariably been in his favor. On numerous occasions and under varied circumstances has this verdict been rendered, each time with greater enthusiasm, and the positions of honor and responsibility to which he has been elected have been equally numerous and varied. He is a true son of the Scranton district, and his identification of himself with the interests of this section has been a most thorough one. Ever the firm friend of progress and development in every direction, he has been a foremost factor in the passage of a number of bills in the legislature, which have benefited the city and state immeasurably.

Hon. John R. Farr was born in Scranton, Pennsylvania. He acquired a sound, practical education in the public schools of Scranton, School of Lackawanna, Keystone Academy, Phillips Academy and Lafayette College. Upon the completion of his early studies he was apprenticed to learn the type setting trade. From his earliest years he had displayed literary ability, and upon leaving college he entered the field of journalism, and rose through successive



*J. S. M. M. M.*



grades until he had attained the position of the city editor of the Scranton Republican. In 1890 he was the successful nominee of the Republican party for representative in the legislature, was re-elected to that office five times, serving during the sessions of 1891, 1893, 1895, 1897 and 1899. He was chosen speaker of the house, January 3, 1899. Among the bills which he was the author of while in the legislature were the following: For free text books for the public school, 1893; compulsory education, 1895, this bill having been presented in 1890 and 1891 by Mr. Farr. Later he was called to a still higher position in the service of his state, being elected to Congress from the tenth congressional district, an office he still holds by re-election, and for which he was re-nominated, May 19, 1914. While in Congress he has pursued a continuation of his services. During his first term he secured a public building for Olyphant, established rural free deliveries in various parts of the county, and was heard on the house floor on all important measures. In his first year he served on the committee of education and on the claims and mining committee; in his second term he had the honor of being placed on the naval committee. He brought about the legislation which restored the revenue district to Scranton. Mr. Farr has always been a forceful factor in the advancement of city improvements. He established the West Side Hospital and West Side Board of Trade.

---

#### ROBERT VANDENBERG WHITE, M. D.

In order to be successful in the medical profession a man must possess, in addition to a good general and professional education, tact, and a training which comes through knowledge of human nature. It is hardly necessary to say that this is applicable to Dr. Robert Vandenberg White, whose name introduces this article, and who has made a reputation for himself in the city of Scranton, Pennsylvania.

(I) Dr. Stephen White, his great-grandfather, was a physician and surgeon in Ireland, his native land. He came to Prattsville, New York, where he lived for a quarter of a century. He married in Ireland, and was the father of two sons and one daughter.

(II) James B. White, son of Dr. Stephen White, was born in Ireland, and was a young man when he came to this country with his father and made his home in the state of New York, where it is probable that he completed his education. He was a tanner by trade, and the owner of the White Hotel at Wymark, New York, which he conducted until his death at the age of seventy-three years. He married Julia Vandenberg, of Dutch descent, born in Lexington, New York, died at the age of fifty-three years, and they are both buried at Lexington. They had children: Arthur, Robert Emmet, of further mention; John, Charles.

(III) Robert Emmet White, son of James B. and Julia (Vandenberg) White, was born in Prattsville, New York, died at the age of sixty years. He attended school at Wymark, New York, until he was fifteen years of age, then entered the employ of the Delaware & Hudson Gravity Road, was advanced to the position of operator, and then became station agent at Scranton, a position he held thirty-nine years. He was a Republican in his political opinions, and a devout member of the Episcopal church. His remains are interred in the Dunmore Cemetery, which is in the suburbs of Scranton. Mr. White married, at Scranton, Mary Bell Talley, now living with her son, Dr. Robert V. White, a daughter of Blythe and Mary (Heilner) Talley, who were among the early settlers of Scranton. Mr. and Mrs. White had children:

Robert Vandenberg, of further mention; Blythe R., a dentist, residing and practicing in Pittston.

(IV) Dr. Robert Vandenberg White, son of Robert Emmet and Mary Bell (Talley) White, was born in Scranton, Pennsylvania, August 28, 1876. He acquired his elementary and preparatory education in the public schools of Scranton and the Lackawanna School of that city. He then matriculated at the Hahnemann Medical College, in Philadelphia, from which he was graduated with honor in the class of 1900. He spent some time in general practice in the St. Luke's Children's and Hahnemann hospitals, of Philadelphia, after which he returned to Scranton, in November, 1902, and opened offices for the practice of his profession at No. 212 South Main avenue, where he is still located, and where he now has an excellent patronage. He was assistant surgeon at the Hahnemann Hospital for a period of two years, became surgeon of this institution in 1906, and has discharged the duties of this office since that time. He has been consulting surgeon of the Wyoming Homeopathic Hospital of Wilkes-Barre, Pennsylvania, for the past five years. He is a member of the Graduates' Council of the Hahnemann Medical College of Philadelphia; a member of the State Institution; of the American Institute of Homeopathy; of the County Medical Society; has been president and secretary of the local medical society; and chairman of the Surgical Bureau of the State Medical Society. He is a staunch supporter of the Republican party, and a member of the Episcopal church. Dr. White married, December 7, 1904, Ella Emily Walter, born in Scranton, a daughter of Michael and Rosine (Steinele) Walter, who were Germans by birth and settled in Scranton at an early date. Children of Dr. and Mrs. White: Robert E., Eleanor Elizabeth, Walter Kent.

---

#### GUY WEBSTER OSTERHOUT

Of ancient Holland lineage, Mr. Osterhout descends from that branch of the family long settled in Wyoming county, Pennsylvania, Nicholson being the family seat. There Webster Osterhout, a well known and prosperous farmer, lived and died, leaving issue, including a son, Milo D.

Milo D. Osterhout was born in Nicholson, Pennsylvania, in 1840, and spent his early life on the paternal farm. On attaining manhood he became a merchant, settling in Providence (now Scranton), a partner in a general store business, but later becoming sole owner, continuing in successful operation until his death in 1890. He married Janet, daughter of Charles Gillespie, who came to this country from Dumfriesshire, Scotland. Children: Joseph G.; Guy W., of whom further; Meta Remington; Alice, married Herbert W. Goodridge; Burton, tax agent for the real estate department of the Delaware & Hudson Company.

Guy W. Osterhout was born in Scranton, February 16, 1876. His early and preparatory education was obtained in the School of the Lackawanna, and Rugby Academy, Philadelphia, he being a member of the class graduated from the latter institution in 1893. He then entered the University of Pennsylvania, class of 1899, and after completing his course, began active work in the profession in which he is now so firmly established. He spent one year with Mr. Corcoran, the well known Philadelphia architect, then went to Wilkes-Barre, Pennsylvania, with A. H. Kipp, remaining with him two years. The next year he spent with McCormick & French, then for nine years was with E. H. Davis, of Scranton, as draughtsman. All these years, preparatory to establishing in business for himself, gave him needed experience and perfected him in the detail of design and construction, the latter now a

most important part of an architect's business. On January 1, 1911, Mr. Osterhout formed a partnership with C. P. Krieg, and worked in association with him until October, 1912, when they dissolved, Mr. Osterhout continuing the business under his own name, with offices at 519 Connell Building. He has had a successful professional career and has designed and supervised the erection of many fine residences and buildings. Among these may be named the store and apartment building of A. M. Storr; store and apartment building of T. A. Eynon; residence of Mrs. Mina Robinson; residence of Otto B. Robinson; residence of C. H. Miller, on Webster avenue; residence of John H. Williams; and the moving picture theatre and apartment building for Dr. J. J. Brennan at Wilkes-Barre. Mr. Osterhout is a member of the Engineers' Society of Northeastern Pennsylvania, the Scranton Board of Trade, Providence Presbyterian Church, and in political faith is a Republican. His college fraternity is Alpha Tau Omega (University of Pennsylvania).

Mr. Osterhout married Phoebe E., daughter of David Smith, of Scranton. Children: Ronald, born January 11, 1902; Charles Gillespie, born October 4, 1906.

---

#### CHARLES G. ROSAR

The story of the immigration of the first American resident of the German family of Rosar, Peter Rosar, is one filled with interest because of its unusual features. Peter Rosar, son of George and Elizabeth (Hartmann) Rosar, and grandson of George Rosar, a farmer of Prussia, was born in Trannenweir, Prussia, October 5, 1835. The eldest child of his parents, he was offered every advantage within their power, and obtained an excellent education in the German schools. When he was about seventeen years of age he journeyed to London, England, there engaging passage on an American-bound sailing vessel. Through unfavorable weather the vessel was so delayed that the voyage consumed seventy-eight days, during the latter part of which time there was intense suffering among both passengers and crew through the failure of provisions and water, an accident that at first caused discomfort and afterward the most severe distress. When Peter Rosar arrived at the home of an uncle in Scranton he was in such a weakened condition because of insufficient nourishment that for a time his recovery was despaired of, but a constitution naturally vigorous and expert medical care and nursing restored him to health within two months. Peter Rosar was followed to the United States within the year by his father, George Rosar, who settled in Scranton and there resided until his death. George and Elizabeth (Hartmann) Rosar were the parents of eight children, four sons and four daughters, all of whom lived in the city of Scranton with the exception of one daughter, Anna Elizabeth, who lived in Elmira, New York.

As soon as he was physically fit for labor after his recovery from his illness, Peter Rosar obtained employment in the mines of the Lackawanna Coal and Iron Company, where he remained for three years, the ten following years finding him associated with the Delaware, Lackawanna & Western Railroad in the boiler shops. He was then for one year employed in the yards of the Lackawanna Coal and Iron Company, becoming foreman of the outside works, a position he held for ten years. His long and satisfactory association with this company was terminated by his resignation, and after its acceptance he established in independent business dealings. In 1866 he had started a grocery store, which his wife managed for a few years, when its growing dimensions brought to Mr. Rosar an appreciation of the possibilities that were contained in that line of trade, to which he afterward devoted all

of his time and attention. His first stock was, by the limits of his resources, small, but he immediately inaugurated a policy of expansion and found little difficulty in securing trade to warrant this course, building up at No. 724-726 Cedar avenue a grocery business large and remunerative. To his line of groceries he added coal, wood, hay, straw and feed, becoming one of the city's prosperous merchants, also acquiring title to the Washington Hotel, on Cedar avenue, Scranton, which he maintained as a first-class house of entertainment. The material prosperity that became his and the prominence that he acquired were the results of deep-seated determination, tireless application, and adherence to principles of honesty and uprightness that never knew a more devoted disciple. Mr. Rosar was a Democrat in matters of national concern, but in local affairs used his influence and cast his vote for the man with representative qualifications and honorable reputation. His only political office was as the representative of the eleventh ward in common council, after which he steadfastly refused nomination for any position. His church was St. Mary's Roman Catholic, in which he was identified with St. Joseph's Society, his fraternal connections being with the Deutsches Selskof.

Peter Rosar married Caroline Zang, born in Altenbach, Prussia, and had children: 1. Elizabeth, at home. 2. Charles G., of whom further. 3. Joseph, a contractor of Scranton, married Mary Phillips, and is the father of: Joseph M.; Frances, cashier in Woolworth's Scranton store; Alma, employed in a Scranton woolen mill; Louise, and the following attending school, Otto, Edna, Mary, Carl, Esther, Ruth. 4. Lena, married Andrew J. Best, proprietor of the Best Hotel on Cedar avenue, and has one son, Andrew J. Jr. 5. William, married Catherine Gard, and is the father of: Romaine, Caroline, and Peter, he is associated in business with his brother, Charles G. 6. Peter J., assistant chief of the Scranton Fire Department; married Charlotte Phillips and has children, Howard and Elsie.

Charles G. Rosar, son of Peter and Caroline (Zang) Rosar, was born in Scranton, Pennsylvania, December 22, 1866. He was educated in the public schools and St. Mary's Parochial School. After leaving school he gained his first business experience as conductor on the street cars, when the South Scranton lines were first opened, after which he spent one year as clerk in the office of the recorder of deeds, three years in the office of the city comptroller, under Edwin J. Robinson, and three years in charge of marriage licenses in the office of the register of wills. After leaving the city comptroller's office Mr. Rosar was elected to the city council from the eleventh ward, on the Democratic ticket, that being the party with which he is affiliated, and at the expiration of his term was re-elected, making four years altogether. He was nominated for recorder of deeds, but was defeated, and about one year later, in 1904, was appointed deputy county treasurer under P. F. Connor, an office he retained for five years, to the eminent satisfaction of all concerned. In 1909 Mr. Rosar was a prominent candidate for the nomination for county treasurer, and made a good run, meeting defeat by only a small margin. He is now, 1914, engaged in the grocery business, with which he has been successfully occupied for several years. He is a director of the South Side Bank, and has other financial interests, including a large coffee company of Buffalo, New York. His fraternal orders are: Scranton Lodge, No. 123, B. P. O. E.; South Scranton Lodge, No. 1145, R. A. He also belongs to the Retail Merchants' Association; Younger Mannechoir and Scranton Sanger Bunde; Scranton Athletic Club; Knights of St. George; and St. Mary's Bund. He is a member of St. Mary's Catholic Church.

Mr. Rosar married, September 6, 1905, Clara Ross, daughter of Peter and Elizabeth (Hailstone) Ross, of No. 902 West Lackawanna avenue, Scranton. The residence of Mr. and Mrs. Rosar is at No. 726 Cedar avenue, Scranton.



## J. NORMAN WHITE, M. D.

Dr. J. Norman White, a physician and surgeon of ability and skill, of Scranton, Pennsylvania, where he enjoys the patronage of a large number of the most select families, is descended from good old New England stock in paternal and maternal lines, his great-grandfather in the paternal line having come from Connecticut.

(I) Sidney White, grandfather of Dr. J. Norman White, married Bessie Scutt, and they had children: 1. Charity, married Henry Rivenberg, of Clifford, Pennsylvania, and has children: Professor Romaine Rivenberg, of Heightstown, New Jersey; Mrs. Dr. Evans, of Crozier Theological Seminary; Dr. S. T. Rivenberg, a missionary to India. 2. Josephine, married Madison Watson, and had children: Dr. S. S. Watson, of Moosic, Pennsylvania; Bessie, married Nathan Slator; Dr. Evelyn Watson, now deceased. 3. Lyman, married Elizabeth Rivenberg, and has one child: Peter. 4. Sidney, married Elizabeth Mackey and has children: Luthur S., of New York; Mark White, of New York; Bessie; Ida; Sidney Jr.; George. 5. Joseph, of further mention.

(II) Joseph White, son of Sidney and Bessie (Scutt) White, was born in Albany, New York, in 1838. He was a farmer. He was a member of the Baptist church. He married Sarah, a daughter of Norman Ford, also of New England stock, and they had children: 1. Augusta, married B. C. Hagadon; children: Ford, Ferris, Raymond. 2. Lillian, married S. M. Stratton, of Los Angeles, California. 3. Elizabeth, now deceased, married B. D. Arnold. 4. Dr. J. Norman, of further mention. 5. Sarah, married George Hamden, of Long Island.

(III) Dr. J. Norman White, son of Joseph and Sarah (Ford) White, was born at Albany, New York, April 12, 1877. He received his elementary education in the public schools of New York state. After graduating from the State Normal School, he was engaged in the profession of teaching for a period of five years, and then matriculated at the Jefferson Medical College, in Philadelphia, from which institution he graduated in the class of 1904, with the degree of Doctor of Medicine. One year was spent as an interne in the State Hospital at Scranton, and he then opened an office for the general practice of medicine in Scranton, and has since been located there. In the short period of ten years he has won high commendation for his ability and for his conscientious devotion to his patients. He has made a specialty of surgical research work, and is visiting surgeon to the West Side Hospital and the Taylor Hospital; and consulting surgeon to the Mid Valley Hospital and the State Hospital for the Criminally Insane. He is Republican in his political opinions, and a member of the First Welsh Baptist Church. His affiliation with various organizations is as follows: County, State and American Medical societies; Hyde Park Lodge, Free and Accepted Masons; Keystone Consistory, Ancient and Accepted Scottish Rite; Independent Order of Odd Fellows. In 1912 Dr. White was appointed deputy county coroner. He married Margaret, daughter of Thomas Jones, of Scranton.

---

 REV. PETER C. WINTERS, LL. D.

Prominent and influential in the ministry of the Roman Catholic church in the city of Scranton is Rev. Peter C. Winters, LL. D., rector of St. Paul's Roman Catholic Church, the congregation of which he has served since January 1, 1910, having previously been connected with religious work in the city of Scranton as assistant rector at St. Peter's Cathedral, a position to

which he was appointed immediately after his ordination. His parentage and ancestry are Irish, that country having been the birthplace of his grandfather, Peter Winters, who had two children: Robert, of whom further, and Mary, deceased, who married William Crawford.

Robert Winters, son of Peter Winters and father of Rev. Dr. Peter C. Winters, was born in Ireland. During his youth he attended school, and later was a clerk in a store in Strabane, county Tyrone, Ireland. He came to the United States when he was twenty-one years of age, and entered mercantile life in Binghamton, New York, in the capacity of clerk, later establishing independently in the same line in Friendsville, Pennsylvania, where for three terms he held the office of postmaster, and where his death occurred August 3, 1889. Friendsville was named by Caleb Carmalt, who in the early days of the nineteenth century brought a number of Quakers from Philadelphia, establishing a Quaker settlement in Susquehanna county. About the same time there came to the place several Catholic families, all well-to-do people who purchased farms in the neighborhood. Mr. Winters married Mary, daughter of Christopher Heavey, of Edenderry, Kings county, Ireland, the ceremony being performed in Narrowsburg, New York. Children of Mr. and Mrs. Winters, eight of whom are living at the present time (1914): 1. Mary, became the wife of William O'Keefe, of Endicott, New York. 2. Robert, deceased. 3. Ellen, became the wife of Patrick Kinney, of St. Joseph, Pennsylvania, and has children: Frank, John, Annie, Margaret, Thomas. 4. James F., deceased. 5. John, a merchant of Binghamton, New York. 6. Rev. Dr. Peter C., of whom further. 7. Joseph, residing near Binghamton, New York. 8. Julia, deceased. 9. James C., engaged in military work, and became sergeant of Battery C, Fifth Artillery United States army; died at Fort Hamilton, January 29, 1900. 10. Sarah, now Sister Superior Anastasia in St. Andrew's Convent, Portland, Oregon. 11. Thomas, resides in Binghamton, New York. 12. Cecelia, married Thomas F. Mangan, of Hawley, Pennsylvania.

Rev. Dr. Peter C. Winters was born in Friendsville, Susquehanna county, Pennsylvania, March 30, 1863. He obtained a general education in the public schools of that locality. His early studies completed, he became a clerk in his father's mercantile establishment, and later taught school at Apolacon and Forest Lake, Pennsylvania. He then entered the Binghamton High School, completing his studies there in 1883, after which he matriculated at Niagara University, and three years later he was graduated with the degree of Bachelor of Arts, receiving the degree of Master of Arts from the same institution in 1904. Immediately after graduation he enrolled in St. Mary's Seminary, at Baltimore, Maryland, as a student of theology, and there received the minor orders and deacon and sub-deacon from Cardinal Gibbons in 1888. He completed the prescribed course in three years, and was ordained into the priesthood of the Roman Catholic church, July 25, 1889, at St. Peter's Cathedral, Scranton, by the late Right Rev. William O'Hara, D. D., Father Coffey, of Carbondale, and Father Connelly, of Scranton, assisting at the ordination. Father Winters was assigned to the Cathedral parish, in Scranton, where he immediately won distinction as a speaker, and he fulfilled the duties of this office for about two years. He next served St. Vincent's congregation, at Plymouth, Pennsylvania, for eight years, being assistant to Rev. T. J. Donohoe. He then became rector of St. Philomena's Church, at Hawley, Pennsylvania, and immediately began to raise funds for a new church. The old church had been erected in 1850 and was dedicated by the late Bishop Neuman, of Philadelphia. The new church was erected at a cost of \$50,000, which sum had nearly all been paid to the contractors when the dedication services were held on June 30, 1901, Bishop Hoban conducting the exercises.



*Rev. P. C. Winter, R.R.D.*



Father Winters was a faithful pastor in Hawley for eleven years, and on January 1, 1910, he was appointed rector of St. Paul's Church, of Scranton, to take the place of Rev. P. J. McManus, founder of the parish. If the institutions within its borders are considered no parish, in or outside the Catholic church, has grown faster, so wealthy and so influential is St. Paul's. The work done in St. Paul's parish the past twenty-seven years is phenomenal, a wonder in church development. The first was a tabernacle, near the corner of Penn and Marion streets, where for a time the few Catholics worshiped; the next was the church edifice with a parochial school on the second story; the next was St. Joseph's Foundling Home; the next St. Paul's Convent; the next Mt. St. Mary's Seminary; the next the Maloney Home, and the latest, the rectory of St. Paul's, the work of Father Winters, which stands as a credit to the parish, the cost of which was \$30,000, a building fit for the church to which it belongs, comparing favorably with the other church property of the city and now entirely free of debt.

Father Winters is the second rector to have served St. Paul's since the creation of the parish in 1887, the parish having been made up of portions of St. Peter's Cathedral, Dummore and Providence. His predecessor in office, Rev. P. J. McManus, is now rector of St. Mary's Church, Wilkes-Barre; he ministered to St. Paul's congregation for a period of twenty-three years. Rev. Dr. Winters is faithful to his duties, constant to the trust placed in him, devoted to the welfare of his parishioners. During his career as a priest he has baptized fifteen hundred persons, married four hundred couples, and officiated at the burial of seven hundred. He is best known by his works, which speak eloquently in his praise, and he is a gentleman of scholarly talents and erudite training, so constituted that, confronted with stern realities and obstacles, he rises to the height of his strength and power in their conquest, a valuable attribute for a leader in the army of Christianity.

In recognition of his scholarship and notable career of twenty-five years in the ministry, his alma mater, Niagara University, at the commencement exercises, June 16, 1914, conferred upon him the honorary degree of "Doctor of Laws." The silver jubilee of Rev. Dr. Winters' ordination to the priesthood was also elaborately commemorated by the Sisters and children of the Parochial School, by the members of his congregation and by his fellow priests, Right Rev. Bishop Hoban, D. D., extending the felicitations of the occasion and Rev. T. J. Comerford, of Archbald, preaching the sermon at the celebration of the event in St. Paul's Church, Sunday, July 26, 1914.

---

#### FRANCIS MATTHEW MONAGHAN

Among the numerous attorneys of Scranton, Francis M. Monaghan is well known by his legal associations and respected for the ability and prowess he has displayed in his profession, with the respect accorded one able man by another. In his ancestry there is much that is interesting, the salient features of which follow.

He is the son of Richard Monaghan, who was born in county Westmeath, province of Leinster, Ireland, a wholesale cattle dealer, who came to the United States in 1846, settling in Honesdale, Wayne county, Pennsylvania. He married Elizabeth Kelley, daughter of James and Elizabeth (McCourt) Kelley. James Kelley, who was a highly skillful weaver of fancy linens, was a son of John Kelley, born in Kilmore Parish, county Monaghan, Ireland. James Kelley came to this country late in life, and died at Honesdale at an advanced age. The children of James and Elizabeth (McCourt) Kelley were: 1. John, married Ann Hazel, and had two children. 2. Frank, married Bridget Jones,

and had one son, James. 3. James. 4. Mary, married Felix Connolly. 5. Margaret, deceased. 6. Owen, married Isabel Brown; their daughter, Ann Jane, married Thomas Canivan; these are the parents of Rev. Francis J. Canivan, deceased, late of the Scranton diocese; Rev. Charles J. Canivan, at present pastor of Saint Dominic's Church, Oyster Bay, New York, in the diocese of Brooklyn; Thomas, John, Eugene and Ann Canivan, of Honesdale. 7. Elizabeth, of previous mention. 8. Grace. 9. Ellen, deceased. Elizabeth came to this country in 1845, married Richard Monaghan. Children of Richard and Elizabeth (Kelley) Monaghan: Daniel, of Scranton, Thomas, of Carbondale, and Francis Matthew, of whom further.

Francis Matthew Monaghan was born at Honesdale, Wayne county, Pennsylvania, May 10, 1857. He attended the public schools of his native town and was graduated from the Honesdale High School, later pursuing his studies under a private tutor for a period of three years and upwards. He then began teaching school at Honesdale, which he continued for six years, at the expiration of that time engaging in the study of law. His preceptor was Hon. William H. Dimmick, and in the four years that he studied in this office he gained a knowledge of the law wide and comprehensive and at the same time accurate and exact. He was admitted to the Wayne county bar in October, 1882, and attained such prominence that two years later he was elected district attorney of Wayne county, serving for three years. In 1901 he opened an office in Carbondale and four years later came to Scranton, where he could more conveniently handle his wide and growing practice. A large practice is the result of the diligent and careful service rendered his clients, and he bears a reputation untainted by any suspicion of irregular or unfair dealings.

Mr. Monaghan married, in 1883, Ellen A., daughter of Richard and Esther (Fitzsimmons) Harnan. Children: Daniel; Ruth; Richard Harnan, married Mary Trager, to whom has been born a daughter, Ruth; Francis; Robert; Marcella. Mr. Monaghan and his family are communicants of St. Peter's Cathedral.

---

#### MICHAEL J. COSTELLO

Both of the two generations of the Costello family of Ireland, who have made the United States their field of labor, have made educational pursuits their life work, and in the case of the junior generation literary distinction and scholarly attainment has been added to that of the teacher. John J. Costello was born in Ireland, and in 1866 came to the United States, settling in Scranton, there following the teacher's profession until the present time. He married Mary, daughter of John Aulker; children: Michael J., of whom further; Mary, married Charles Robinson, of Scranton; Catherine, Rose, Florence, Anna.

Michael J. Costello was born in Scranton, Pennsylvania, March 12, 1880. He obtained his early education in the public schools of Scranton, later attending St. Thomas' College. He then matriculated at Holy Cross College, Worcester, Massachusetts, receiving the degree of A. B. at his graduation in 1900, the same institution honoring him with his Master's degree in 1911. He began his relations with educational work as vice-principal of the Dunmore School, a position he held for five years, resigning to become professor of English in the School of Technology. From 1907 to 1908 he was principal of the Carbondale High School, in the latter year accepting the vice-principalship of the Scranton Technical High School, a position which, by education, training and experience, he was eminently qualified to fill. He still serves that institution in that capacity and has played no unimportant part in the develop-

ment, improvement and progress of that institution, which now holds high rank among schools of a similar nature and in points of equipment and faculty lowers its colors to none in its class.

Mr. Costello has not, however, become so deeply immersed in his work that he has neglected the exercise of the other liberal talents with which he has been endowed. The possessor of a magnificent education, the result of studious application in his college years and indefatigable study and research after academic instruction had ceased, has made him a scholar of breadth of knowledge and depth of appreciation. Literature and its history, its causes and effects, have been prominent features of his study, and as a result of his clear insight into and understanding of this subject he has published several essays instructive for their content and delightful for the purity of their expression, among his best known compositions being, "Minor Poets of the Nineteenth Century," "Poetry of Tennyson," "Women of Shakespeare," "Pennsylvania in Literature," and "The Irish in Literature." Mr. Costello does not confine the expression of the results of his studies to written compositions, but is a lecturer of fluency and eloquence, possessing the indescribable quality that enables a public speaker to throw not only his sentences, but his personality, from the platform whereon he speaks. A quick thinker and ready speaker, the nature of his audience rarely troubles him, and he adapts himself to circumstances with an ease and grace wholly natural.

Mr. Costello married, in 1905, Mary Dunleavy, and with his wife is a member of St. John's Church. He is a member of the Teachers' Mutual Benefit Association, of Scranton, and is vice-president of the Teachers' Retirement Board. His residence is No. 1418 Pittston avenue, Scranton.

---

### WILLIAM HAGGERTY

There is always respect accorded the man who, unprepared by experience and untaught, enters a strange field of endeavor and there carves out a worthy record. Impractical in business, impossible in professions, such a performance is almost as difficult in public life and politics, so that the achievements of William Haggerty as a member of the lower house of the state legislature, to which he was elected from the ranks of private citizenship, assume more striking dimensions than those created by consideration of their conspicuous merits.

Mr. Haggerty is a public servant of four years' standing, having advanced to such station from practical mining, pharmaceutical pursuits, and scientific work in connection with the department of bacteriology of Scranton. He was placed in the state legislature in 1910 and re-elected to the same office two years later, and during that time has championed valiantly legislation of estimable value designed to serve excellent ends, a more particular account of his activities as a legislator following.

His ancestry is Irish, his father, Daniel Haggerty, son of James and Mary Haggerty, having been born in Ireland, where he passed his youth. His immigration to the United States was in company with his mother, the family home being in Dunmore, where Daniel Haggerty was employed in the mines. While following this calling, at the age of forty-six years, he met an accidental death, being crushed by a heavy fall of slate. He married Ann, daughter of Richard and Catherine Walsh, a native of Ireland, and was the father of ten children, seven surviving to this time (1914). He was a Republican in politics, and with his wife belonged to St. Mary's Roman Catholic Church.

William Haggerty, son of Daniel and Ann (Walsh) Haggerty, was born in Dunmore, Pennsylvania, October 16, 1870. After attending the public schools

of his birth-place he completed his studies with a course in the Scranton Business College. He was for a few years a miner, in 1899 studying pharmacy in connection with hospital work, later passing the examinations of the State Board in that profession. On April 1, 1907, he was made assistant bacteriologist of the city of Scranton, an office he held until January, 1914, when he retired from his relations with that department. Mr. Haggerty's public career began in 1910, when he was the successful Republican candidate from his district for the legislature, to which he was returned the following election, and on November 3, 1914, he was again elected to the same position. That the fourth district chose well its representative his record shows, for not only did he staunchly support measures of deserving aspects, but was responsible for the introduction of eleven bills, eight of which, receiving the approval of both houses of the legislature, were signed by the governor and became laws of the state of Pennsylvania. These laws cover a wide range of responsibility, the diversity of their nature showing their author to be a man recognizing the obligations of the state to her people as well as one in whom the elements of human sympathy, love of fellow-men, and desire for justice hold strong sway. Among the legislation of which he might justly be called the father were the following bills: To require fire drills in public schools; to require fire drills in factories, and industrial establishments where women or girls are employed; fixing the width of public highways, where such highways are crossed above or below grade by the tracks of any railroad, except in cities or boroughs; providing a system whereby boroughs may build sewers; grade and sub-grade, and pave streets and alleys; pay the costs thereof by the issue of bonds, and collect the same from the property benefited, by installments; making an appropriation to the West Mountain Sanatorium (Consumptive Hospital) of Scranton, Pennsylvania, the sum of five thousand dollars (\$5,000.); making an appropriation to the Home for the Friendless, of Dunmore, Pennsylvania, the sum of ten thousand dollars (\$10,000.); making an appropriation to the St. Joseph's Home and Maternity Hospital, of Dunmore, Pennsylvania, the sum of ten thousand dollars (\$10,000.); making an appropriation to the Mid-Hospital, of twelve thousand dollars (\$12,000.); providing for the election of a borough controller in all boroughs of this commonwealth; Mine Cave Bill passed the house on March 25, 1913.

Able in defence of any measure for which he stands sponsor, Mr. Haggerty has always been willing to invite and quick to overcome opposition to the causes he has supported, and has so gained the respectful regard of his colleagues. So runs the record of his four years of public service, marked by zealous attention to duty and activities wisely directed and forcefully completed. His ambitions have never been above the service of his constituents, and in his fulfillment of the trust reposed in him by them he has found pleasure and satisfaction.

---

#### AUGUSTUS CHARLES NETTLETON

Descended from an old New England family, Augustus Charles Nettleton is a native of New York, whither his parents, Edward and Harriet (Clark) Nettleton, came from Milford, Connecticut, the former named born in Old Milford, Connecticut, March 17, 1804, died in Fulton, New York, February 19, 1864, buried in Fulton, New York, and the latter named born in Woodbury, Connecticut, July 28, 1808, died in Put-in-Bay, August 23, 1878, buried in Mt. Adner Cemetery, Fulton, New York. They were married September 18, 1833.

After the marriage of Mr. and Mrs. Nettleton they resided at Milford.



Connecticut, and removed thence to Plymouth, Connecticut, where two children were born, Catherine and Martha, both now deceased. They then removed to Fulton, New York, where four children were born: Franklyn Edward, of whom further; Samuel Wesley; Augustus Charles, of whom further; Albert Eugene, all four sons being now engaged in shoe manufacturing and dealing, the Nettleton shoes being known throughout the United States and the world.

Franklyn Edward Nettleton was born in Fulton, New York, December 29, 1838. He attended the schools of Fulton and Williams College, Williamstown, Massachusetts, and then engaged in the boot and shoe business with his father, the business eventually coming under the control of the four sons, as aforementioned. From Fulton, New York, Mr. Nettleton removed to Pittsburgh, Pennsylvania, where he remained for one year, and in 1867 took up his residence in Scranton and has been a resident of that city since that time with the exception of every winter for the past twenty-nine years which he has spent in Florida. In 1886 he disposed of his shoe business in Scranton, and since then has lived retired from active business pursuits. He has served as president of the State Sunday School Association of Florida, which he organized, also as president of the Christian Endeavor Association. Served as president of the Grace Nettleton Home and School, now known as the Grace Nettleton Foundation of Lincoln Memorial University, of which he is now the financial secretary. This home is situated on the hillside overlooking a magnificent view of one of the most beautiful and fertile valleys in this country, at Harrogate, Tennessee, on the great and only highway for many miles, leading from the states of Tennessee and Virginia into Kentucky, through Cumberland Gap, the scene of seven of the most important conflicts of the great Civil War. It was opened in December, 1899, by Miss Emily Winters, of Springfield, Massachusetts, as a home and school for the training and education of the destitute and homeless mountain girls of that neglected section of this country. Three hundred and fifty girls have thus been cared for in the past fourteen years, and in addition over four hundred boys and girls in that neighborhood have been taught in the day and Sunday schools. This home was named in memory of Grace, the deceased daughter of Mr. Nettleton. For a number of years Mr. Nettleton was secretary and manager of the Tri-State Association of Sunday Schools; he was the originator of the Pennsylvania State Sunday School Association and an ex-committeeman; organized four Sunday schools and served as superintendent of five, opening Sunday schools in four different states. He called the first meeting for the organization of the Young Men's Christian Association in Scranton. He is a trustee of Lincoln Memorial University in Tennessee, also director of Rollins College, of Florida, and president of Yellow Cliff Land & Improvement Company.

Mr. Nettleton married, May 1, 1865, Marion F. Smith, a native of Fulton, New York, died January 13, 1913, buried in Forest Hill Cemetery. Child, Grace, born May 16, 1870, died February 13, 1883, buried in Forest Hill Cemetery.

Augustus Charles Nettleton was born in Fulton, New York, August 23, 1844. He was there reared and educated, pursuing his advanced studies in Falley Seminary, of that place. After discontinuing his scholastic activities, he was for three years a shoe merchant of Fulton, New York, purchasing the business of his brother, Samuel W. Nettleton, and in 1871 removed to Scranton, Pennsylvania, where he has since resided, and where he has attained not only success in his operations but reputation as a business man of uprightness and principle. Since taking up his residence in Scranton Mr. Nettleton has

had several business locations, having been for twelve years at No. 314 Lackawanna avenue, three years at No. 228 Lackawanna avenue, eight years at No. 411 Lackawanna avenue, nine years in the Commonwealth Building on Lackawanna avenue, seven years in the Burr Building, then moving to his present place of business, No. 223 Spruce street. He has associated with him his son, Edward F. Nettleton; he has a large business in the mining districts of east central and northeastern Pennsylvania. The prosperity and success that have come to him have been directly attributable to his close application to his business, the wise judgment that has actuated his every dealing, and the fairness that has governed all of his relations with his fellows. He is a communicant of the Green Ridge Presbyterian Church. He is a Republican in political preference.

Mr. Nettleton married, at Syracuse, New York, Emma Chase, born in that city. Children: Marie, Catherine, Edward F. and Albert, living, Charles and Cyrus, deceased.

---

#### JAMES L. CRAWFORD

James L. Crawford, deceased, for many years president of the Peoples' Coal Company, Scranton, and one of the widely known coal operators in the anthracite region, was a striking feature among the truly remarkable men who have been conspicuous in the coal industry of Pennsylvania during the past quarter of a century. Of great force of character, broad sympathy and public-spirited, he was an American of the highest type, in thought, word, deed and ambition. Without favoritism to aid him, he carved out his own career, beginning in the humblest walks of severe manual labor, and lifting himself to a position of wealth and commanding influence quite notable even in these days of great accomplishments. Through all and to the last he was unashamed of his beginning, and his own experiences but warmed his sympathy for working men and made him their friend. He died in the prime of life, at a time when he might have determined, had he seen fit, to retire from active occupation and rest in the enjoyment of the fruits of his labors. His life in his later years was a contribution to the comfort and happiness of all about him, and the narrative of his unvaried success and the uses to which he put his effort and means should serve as an encouragement and inspiration to the unaided toiler in all this region.

Mr. Crawford was born in Noxen, Wyoming county, Pennsylvania, in 1851, a son of the late Ira and Elizabeth Crawford, both natives of the same county, and a grandson of Benjamin Crawford, who during his boyhood days removed with his parents from Connecticut to Pennsylvania, in which state he resided until his death at the extreme old age of ninety-six years. Ira and Elizabeth Crawford were the parents of four children.

Early thrown upon his own resources, James L. Crawford was afforded little in the way of school education. Of such opportunities for self information as came to him he made the best possible use, and when he entered upon an independent career his mental equipment proved amply sufficient for his every need, enabling him to successfully cope with men whose advantages at the outset, in training and means, far exceeded his own. He was but a boy when he secured employment in the old Seneca mine of the Pittston and Elmira Coal Company in Pittston, and he continued to work here for some years, passing through the various gradations of door-tender, laborer and miner, at each step demonstrating his efficiency and his capability for more important tasks. His preparation was so complete that he was called to the superintendency of the Wyoming Valley Coal Company, which he also served

in the capacity of civil engineer. In 1876 and for two years thereafter he was a contractor for the building of breakers, and there are many of these structures in the anthracite region to-day which stand as monuments to his ability in that line. Later he removed to Bradford, where he built derricks and speculated in oil. In the spring of 1879 he returned to the anthracite coal belt and for four years served as mine foreman for the Charles Hutchings collieries. In 1883 he entered the employ of J. H. Swoyer & Company, and three years later took up his residence in Jermy, where he remained for eight years.

In 1884 Mr. Crawford became identified with the collieries in which Simpson and Watkins were interested, and while serving as superintendent he had charge of the opening and development of the following collieries: The Edgerton, Northwest, Grassy Island, Sterrick Creek, Lackawanna, Babylon, Mount Lookout, Forty Fort and Harry E. He was financially interested in these collieries and remained as general superintendent of the company until 1899, when Simpson and Watkins sold their interests to the Temple Iron Company. Mr. Crawford was superintendent of the last named company for one year, when he resigned on account of ill health.

In 1901 Mr. Crawford became the principal owner of the People's Coal Company, of which he was also president, with his step-son, James G. Shepherd, as secretary and treasurer. It was during this period that Mr. Crawford became a prominent figure in the public view, his management of the Oxford mine being marked by two distinct successes—a quick accumulation of great wealth, and his marked victory over the Miners' Union during the great strike of 1902. During the six months' duration of this great contest the Oxford was the only mine in the entire region which was kept in operation, and his conduct gave exhibition of his strongest traits of character. His determination to keep the colliery in operation was not due to a spirit of defiance. As he stated at the time, he held to the conviction that a man possessed the unrestricted right to work or not to work, at his own election, without regard to the mandates of any organized body, especially when he was personally satisfied with his wages and condition. He maintained that the Oxford miners were satisfied, and were not demanding either increase of wages or adjustment of any differences, and that under these conditions if the workmen were content to continue their labor, he was determined that they should do so without molestation and with full protection. Many of his friends considered the conditions confronting him as unsurmountable, but his courage and determination seemed to increase as the obstacles grew, and he was soon engaged in one of the most gigantic struggles which marked the great strike. He first gathered about him his old and trusted employees, who trusted in him so implicitly that they expressed their determination to stand by him to the last. Keeping the mine at work to its accustomed capacity, he provided for the safety and comfort of the men by erecting eating and sleeping quarters at the colliery. He also organized an armed force for patrol duty about the premises, which he enclosed with a strong barricade, and operated a large searchlight for the discovery of an attacking force. His preparations were so complete that the plans of the would-be attackers were set at naught, and the Oxford mines remained in operation throughout the strike period, while numerous other collieries were obliged to close down and ultimately yield to the demands of the Union. As a reward Mr. Crawford made a large fortune as a result of his continuing mining during these fateful times, and in recognition of the fidelity of his employees he distributed among them some thirty thousand dollars prorated according to their respective earnings. The giving of this bonus was remarkable in view of the fact that no mine in the

region, or probably in the entire country, paid out such large sums in wages to their miners, one miner earning as much as \$2,800 in one year. Mr. Crawford frequently explained, when questioned, that his bonus to his men was in recognition of their fidelity to him during the strike. His relations with them were the happiest that could be conceived. One of his friends related that when the strike was at its height he went with Mr. Crawford to every chamber in the mine. In each instance Mr. Crawford addressed the miners by name, and their manner in responding was full assurance that they were prepared to go much further than they did to aid him in conquering success. It is further a notable fact that as a result of his effort and success, the Oxford mine is the only one in the anthracite region where there is no local branch of the United Mine Worker's Union.

While Mr. Crawford was a large stockholder in various corporations, he was only identified with one in an official way, the Spring Brook Water Supply Company, in which he was a director. In all others he was represented by his step-son, James G. Shepherd. He never sought or held a public office, being entirely averse to official distinction. He was, however, broadly public-spirited, and liberally aided every movement tending to benefit the community. Few if any could estimate the extent of his philanthropy. He rejoiced in giving without display and frequently made it a condition that his donation should not be given publicity. Scarcely a church of the Methodist denomination in the Wyoming Valley but was materially assisted by him, and in some instances where a new church building had been erected, he contributed the greater portion of the expense, and asked that his contribution be unnamed. He was one of the best friends of the Florence Mission, the Hahnemann Hospital, and other local charitable and humanitarian institutions which never appealed to him in vain. He was a man with a remarkable sympathetic heart, afforded aid with counsel and means to many young men, and rejoiced in their success, while he studiously refrained from displaying the fact that their good fortune was grounded upon aid which he had extended to them. He was in all things a practical Christian and an exemplary member of the Elm Park Methodist Episcopal Church of Scranton.

In 1882 Mr. Crawford married Hulda A. Wilcox, daughter of James and Sarah Wilcox. Of this marriage were born two children, Byron and Norma, both of whom are deceased. Mr. Crawford died February 19, 1905, at Indianola, Florida, from heart failure. His sudden demise was a great shock to the community, to which it was also an irreparable loss. The remains were interred in the family plot at Dunmore Cemetery, Scranton, Pennsylvania. The tributes to his memory were many and fervent. It is said of him that his gospel of work was annotated by a large measure of human interest in everything that concerned the moral and physical welfare of the community. He never forgot that he rose from the lowest round of the industrial ladder, and those who worked under him he regarded and treated as co-laborers. He earned the gratitude of everyone, who was sufficiently just to see in his example the promptings of a kindly heart. Mrs. Crawford, who survives her husband, possesses in a marked degree the characteristics of a Christian woman, and in the various capacities of daughter, wife and mother has ever faithfully and earnestly performed all duties and responsibilities devolving upon her. She is among the foremost of the charitable and generous women of Scranton, constantly performing some deed of charity, and all philanthropic and humane institutions, also private demands, and, in fact everything calculated to uplift mankind and elevate humanity, ever receive from her a prompt and generous response. She is dispensing her ample means with the same generous hand which characterized the action of her late husband

during the latter years of his useful life and in every way possible is endeavoring to fulfill his wishes and intentions. She is greatly beloved by all who enjoy a close and intimate acquaintance, and highly respected by all classes in the community.

---

### REV. JOHN JOSEPH LOUGHAN

The Catholic diocese of Scranton has within its borders no priest better prepared, by years of unceasing study and earnest consecration, to give his life's services to the Roman Catholic church, nor does it boast of one within its limits more faithful in his devotion to the members of his parish or more disinterested in his efforts in their behalf. Trained and educated for his calling in the leading institutions of the church, as the rector of the Church of the Nativity of Scranton, he is the leader of a congregation among whom he unselfishly labors and whose demands upon him are met in a cheering and cordial manner that has endeared him to their hearts.

Rev. John Joseph Loughran is a son of Patrick Loughran, who was born in Ireland, died in Pennsylvania, 1902. He married, Mary O'Hare, who died in Scranton, 1910, daughter of Anthony O'Hare, who died in Pennsylvania in 1893. Children of Patrick and Mary (O'Hare) Loughran: 1. Elizabeth, married Charles O'Boyle, of Olyphant, Pennsylvania. 2. Rev. John Joseph, of whom further. 3. Catherine, a stenographer, resides in Scranton. 4. James, a mechanic, resides in Scranton. 5. Thomas, a salesman. 6. Mary, a bookkeeper, resides in New York. 7. Francis, deceased. 8. Lucy, a teacher in school No. 42, of Scranton, Pennsylvania. 9. Theresa, a teacher in School No. 3, of Scranton, Pennsylvania. 10. Helen.

Among the other members of the Loughran family who entered the priesthood were Father John Loughran, rector of St. Joseph's Parish, of Minooka, Pennsylvania, who died in 1899, and Father James Loughran, who died in Great Bend, Pennsylvania, in 1883, both of whom were cousins of Rev. John Joseph Loughran.

Rev. John Joseph Loughran was born at Archbald, Pennsylvania, September 26, 1871. He began acquiring his exceptionally fine education in the public schools of Archbald, and when seventeen years of age entered St. Bonaventure College, Allegany, Cattaraugus county, New York, whence he was graduated in 1890. He was then adopted as a clerical student to the diocese of Scranton by Bishop O'Hara, and was afterward enrolled in St. Mary's Theological Seminary, at Baltimore, whence he was graduated with the degree of S. T. B. in 1895, this making three degrees conferred upon him by this same institution, that of B. S. being conferred in 1891, and his master's degree in 1892. On June 20, 1895, he was ordained into the priesthood in the cathedral at Baltimore, and his first charge after his ordination was assistant at Carbondale, where he spent his summer vacation in 1895. In the fall of that year he entered the Catholic University at Washington, Pennsylvania, and after two years of hard and unremitting application to his studies was given the degree of S. T. L., having spent the summer of 1896 as assistant pastor of Overton, Bradford county, Pennsylvania, thus adding to his practical acquaintance with, as well as his theoretical knowledge of, the priesthood. After completing his course at the Washington University he was appointed assistant to Father O'Donnell, rector of the Holy Cross Church of Scranton, serving in that capacity until his selection by Bishop Hoban to act as his secretary and as chancellor of the diocese of Scranton. Bishop Hoban granted him a leave of absence in 1900 and Rev. Dr. Loughran sailed for Rome, there to enter the world famous Gregorian University, this institution dignifying

him with the degree S. T. D. in June, 1902. Returning to the United States to the Scranton diocese immediately after receiving his degree he was re-appointed by Bishop Hoban to his former position, as secretary and chancellor of the diocese. He remained in the cathedral until August, 1907, when he succeeded the late Rev. James A. O'Reilly, in the rectorship of the Nativity Parish.

In the practical life of church work his fine training has borne much fruit and his parish has been enriched and strengthened by the noble service he has rendered. The first building on the site of the present Church of the Nativity was but a small structure, erected in 1844, and was at that time the only Catholic church in Scranton. Twelve years later a larger and more handsome edifice was built in the central city. In 1904 Father O'Reilly began operations on the present church and carried the basement chapel through to completion, also raising the stone superstructure, but at this point funds failed and interest languished. When the Rev. Dr. Loughran succeeded to the rectorship he took up the loose ends of this uncompleted task, injected fresh vigor into the work, roused the congregation to renewed efforts, and September 13, 1914, brought the project to a happy and successful conclusion, at an aggregate cost of \$225,000.00. Nor is this the only constructive work of which he has been the moving spirit, for a beautiful and imposing stone rectory has been built at a cost of \$40,000, the church now possessing buildings surpassing any others of a like character in the city. It is this spirit of accomplishment and the impetus to forward steps that makes Rev. Dr. Loughran the ideal organizer. Nor does his ability to organize thoroughly, efficiently and effectively comprise his only talent, for he has also the gift of cementing a congregation into more perfect fellowship and of sustaining interest once aroused.

To turn from his work to the man, he is found genial, cultured and educated in the highest sense of the word. His manner is charmingly courteous, his conversation pleasant and interesting and his whole personality one to which many are attracted and held. He would grace a college professorship as ably and as naturally as the priestly habiliments, so thorough and extensive has been his magnificent education, yet a friend less favored would find no embarrassment in the presence of such extraordinary learning. His is the gift, so indispensable to those thrown much with people, of mingling with all, his bearing marking him always a scholar and as constantly a gentleman. He is a member of the Knights of Columbus, the Catholic Mutual Beneficial Association, and at the present time holds the diocesan office of "Defensor Matrimonii" (Defender of the Marriage Tie).

The Church of the Nativity of our Lord was begun in the year 1904 by Rev. James A. O'Reilly, who was appointed first rector of the newly established parish on November 1, 1903. The basement chapel was opened for worship in the early part of the year 1905 and continued to be used for that purpose until November 29, 1914, on which day the completed church was dedicated with great solemnity by Archbishop Prendergast, of Philadelphia, in the presence of His Eminence, James Cardinal Gibbons, and of a large gathering of bishops and priests who represented many dioceses in the eastern states.

The new Church of the Nativity awakens many interesting and pleasant recollections, especially among the oldest residents of Scranton. A few still survive who can recall the erection of the first Catholic church in this city in the year 1848 and quite a number remember the days when they frequented that simple, primitive place of worship. It stood on the ground which is now graced by the imposing and beautiful structure of Nativity Church. As far back as 1844 Nativity Place was hallowed by the offering of the Holy Sacri-



*Rectory and Church of The Nativity of Our Lord*





fice of the Mass. Father Cullen of the diocese of Philadelphia was the first priest to minister to the needs of the faithful in the little hamlet then known as Slocum Hollow. An humble company house, an adjunct to the Scranton Iron Works, was the scene of his ministrations.

Owing to the development of the Scranton Iron Works and to the constantly increasing number of Catholic immigrants a regular place of worship became an urgent necessity. In consequence a plain unpretentious chapel, but splendid in the sacrifices it involved, was erected by the small Catholic population under the direction of Father Cullen. In 1852 the Rev. Moses Whitty became pastor of this church and during the incumbency of this pious and zealous priest the Catholic contingent increased very rapidly both in number and in fervor.

The pioneer chapel had served its time and its purpose. It responded well to the humble beginnings of Catholicity in this city but after a few years a more spacious and more convenient church was demanded by the large and scattered Catholic population. The church which once occupied the corner of Franklin avenue and Spruce street was the result. This church in its turn, owing to inadequacy, gave way to the present Cathedral of this city.

The Cathedral parish grew and expanded with the city of Scranton. It became unwieldy owing to the number and territory it comprised. Hence the Rt. Rev. M. J. Hoban, in his zealous and watchful care of the children committed to his charge, thought it advisable and opportune to cut off the south section of the Cathedral parish and give to the Catholics of that quarter another church and another pastor. This he did in 1903 placing in charge the zealous and beloved Father James A. O'Reilly, then rector of the Cathedral.

"History repeats itself," and Father O'Reilly, looking upon the establishment of the new parish as a happy coincidence and a restoration to primitive prestige, set out at once to erect a church which would be a fitting monument to the birthplace of Catholicity in this city and named it "The Nativity." By his efforts also and the kind co-operation of the city council the locality was called "Nativity Place." Although Father O'Reilly did not live to see the church, the cherished object of his heart, brought to completion, yet he impressed upon the walls reared by him a dignity and a majesty which served as a norm or standard to his worthy successor, Rev. J. J. Loughran, D. D., who had the honor of perfecting the work so well begun by his revered and lamented predecessor. Nativity Church stands to-day a noble and artistic monument to Catholic faith, the pride of Nativity parish and the boast of the city of Scranton.

---

#### FRED B. ATHERTON

The Atherton family of Lackawanna county, Pennsylvania, founded in that locality from the original American home in New England, needs here no introduction. Its members are known in this vicinity by the lasting monuments of useful lives, activity well-ordered, and service willingly and efficiently rendered. (A complete line of the Atherton family is found elsewhere in this work.)

Fred B. Atherton, son of Bicknell B. Atherton and grandson of Jonathan Atherton, was born in Providence, Scranton, August 11, 1885. His father was reared in this city, and when the Civil War broke out he enlisted as a private in the One Hundred and Forty-first Regiment Pennsylvania Volunteer Infantry, was advanced steadily, finally receiving his commission as first lieutenant in Company H of that regiment. During the course of this conflict he was thrice wounded, at Gettysburg, Chancellorsville and Spottsylvania,

participated in eighteen important battles and numberless skirmishes and encounters with small detachments of the enemy. His honorable discharge from the service came at the end of four years of service in the field, during which time he displayed qualities of the truest manhood, inspired by patriotism and supported by gallant bravery. He is a Republican in political sympathy, an original companion of the first class of the Military Order Loyal Legion of the United States, Commandery of the State of Pennsylvania, and a member of the Providence Presbyterian Church, of which he was once a trustee. His Grand Army of the Republic Post is Ezra Griffin Post, No. 139. Bicknell B. Atherton married Amanda, daughter of J. D. and Jane (Rockwell) Safford, of Lathrop, Susquehanna county, Pennsylvania, who was reared and educated in that locality, and who died in 1907, aged forty-eight years. Children of Bicknell B. and Amanda (Safford) Atherton: Dudley R., cashier of the North Scranton Bank; Grace, married J. E. Adamson, of Sayre, Pennsylvania; Fred B., of whom further.

Fred B. Atherton passed his youthful years in the city of his birth, and there completed courses in the grammar and high schools. After graduating from Scranton High School he was assistant in chemistry there from 1901 to 1905, afterward matriculating at Lafayette College, where he completed the course in chemistry in the class of 1909. After leaving college Mr. Atherton formed his first business association with the Third National Bank in a clerical capacity, resigning his position in this institution to enter the employ of Brooks & Company. After a year's connection with this concern in the position of chief clerk, Mr. Atherton was, in 1910, appointed manager, his present office in the employ of Brooks & Company. His relation to the business has been one most satisfactory in every manner, satisfaction created by his able discharge of his important duties. Mr. Atherton is a devotee of outdoor recreation, indulging his liking in this direction through membership in the Scranton Country Club and Scranton Tennis Club. While a student at Lafayette he lightened the work of college life by his activity in numerous social, musical and fraternal societies, among them being elected a member of the Phi Delta Theta National Fraternity, the Knights of the Round Table, the Upper Classmen's Society, the Chemical Society, and the Glee and Mandolin clubs. He is a member of the Second Presbyterian Church, and a strong Republican supporter. Mr. Atherton is a member of the Pennsylvania Society Sons of the Revolution, and the New England Society of Pennsylvania. He is treasurer of the Scranton Chemical Laboratory Company and assistant treasurer of the Central Realty Company.

Mr. Atherton married, October 29, 1912, Ruth Lansing, of Scranton, daughter of James A. and Fannie (Waters) Lansing, and has one son, James Lansing.

---

#### MICHAEL E. McDONALD

A resident of Dunmore from 1864 until 1892 and from the latter year a resident of Scranton, Mr. McDonald has in the character of lawyer, statesman, business man and editor added to the material prosperity of the districts named and in his public career been of inestimable value. The legislation which he introduced or aided valiantly while a legislator was most practical and far-reaching in its benefits, while his work in committee and on the floor of house and senate was disinterested and peculiarly valuable to those striving to enact needed legislation.

Mr. McDonald was born in Hawley, Wayne county, Pennsylvania, September 26, 1858. He was six years of age when his parents moved to Dunmore, where he obtained his education in the public schools, finishing his

academic study at Wyoming Seminary. He chose the profession of law and in 1881 registered as a student with Lemuel Ammerman under whose able preceptorship he qualified, obtaining admission to the Lackawanna county bar at the October term of 1883. He at once established an office and began practice in Scranton, was admitted to the Supreme Court in 1886, and later to all state and federal courts in the district. He has since conducted a general law practice, and has obtained high rank as a learned, able, upright lawyer and counselor. While the law and its pursuits has ever been his ruling passion, he has not allowed it to absorb his attention to the exclusion of the claim the state has upon its loyal sons. From early life he was interested in public affairs and early assumed the responsibilities of a public official. When barely of legal age he was elected auditor of the borough of Dunmore, and for three years served in that capacity, developing those traits of character and devotion to the public interest that characterized his later career. In 1884 he was elected school director, served for three years as such, two of these years being president of the board. In 1886 he was the nominee of the Democratic county convention of Luzerne to represent the eighth district in the state legislature, an office to which he was elected the following November by a most gratifying majority. In 1888 he was elected from the fourth legislative district of Lackawanna county, which was formed under the appointment act of 1887. In the house his course had been carefully watched by his constituents and so closely was he associated with important legislation and so ably had he demonstrated his value as a legislator that in 1890 he was chosen as the Democratic standard bearer of the twentieth senatorial district. After a hard-fought campaign he was returned the successful candidate for a term of four years, and in the state senate continued the valuable work begun in the lower body of the legislature. During the four sessions of the legislature in which he sat as representative and senator he served with ability and zeal on important committees and was able to influence much valuable legislation. As a member of committees, appropriations, railroads, mines and mining, judiciary, general and special corporations, municipal corporations and elections, his work was tireless and persistent. Valuable as was his work in committee it was equalled by his personal work on the floor in debate and forcing passage of bills. He was particularly active in securing the passage of a bill increasing the number of law judges in Lackawanna county from two to three; in securing appropriations for Lackawanna Hospital, the Oral School for Deaf Mutes, Carbondale Hospital, the Miners Hospital at Pittston and for the public schools of the state. Largely the result of his personal effort was the passage of the "Mechanics Lien Law" that placed the mechanic and laborer on an equality with those furnishing material in the collection of claims against a building. He twice introduced an employers' liability bill and several laws of benefit to the boroughs of Pennsylvania were introduced and championed to a successful issue. While these were the higher attitudes reached by Mr. McDonald in his public career there are many other features that show the esteem in which he is held and of his strength in the councils of his party. In 1882 he was a delegate to the state convention that nominated Robert E. Pattison as the Democratic candidate for governor. The following year he was chosen a member of the state central committee and later served many years on the Lackawanna county committee. In 1883 he was appointed by the court auditor of the Scranton poor district, serving three years. He was also for six years solicitor of the borough of Dunmore, filling all offices with equal zeal and devotion to the public interest. Nor does his professional and official life show the full measure of his activity. He has been identified with the industrial development of Scranton, and with many charitable and philanthropic

institutions of the city. He is the publisher and editor of the Lackawanna Jurist, the official legal publication for several courts of the county, and director in the Laurel Line (Lackawanna & Wyoming Valley Railroad Company) and many other industrial enterprises. So, from whatever angle he be viewed, the value of Mr. McDonald as a citizen is strongly apparent. He is still "in the harness," conducts a lucrative law practice, and has interest in all that pertains to the public good.

Mr. McDonald married, in Scranton, November 23, 1892, Martha L., daughter of Edward Mellson. Children: Randall, Maurice, Janet, Martha.

---

#### ARTHUR DUNN

Dating back to a Scotch-Irish pregenitor, John Dunn, a Revolutionary soldier from the state of Connecticut, Arthur Dunn rightfully inherits the qualities that have contributed to his present leadership in Lackawanna county. The Dunn family were intermarried with the Rob Roy family of Scotland. John Dunn had a son, William Dunn, who also served in the Revolutionary War from Connecticut, later settling in Elmira, New York, where he lived on Water street, east of Sullivan, there being now no trace of his residence. John Dunn had four sons killed in the Wyoming massacre. William Dunn first engaged in merchandising, and later was for several years proprietor of the "Black Horse" tavern in Elmira, at the corner of Lake and Water streets. He lived for a time in Bath, Stueben county, New York, where some of his children were born. Later he settled in Chemung Valley, New York, where he built the first grist mill in association with Judge Payne. He lived to be ninety years of age. His widow married (second) John Davis, although very much his senior. William Dunn was made a Mason in August, 1793. He had several sons, all of whom became politically prominent. Charles W., the eldest, is said to have been the first white child born in Bath, but passed most of his eighty-five years in Chemung county, a merchant and landlord, proprietor for many years of the Franklin House at Horseheads, New York. Thomas, another son, was a merchant, and married a daughter of Dr. Elias Satterlee.

William (2) Dunn, another son, was an unusually brilliant young man and one of the finest of public speakers. He was an ardent Whig and a great admirer of Henry Clay, whom he greatly resembled in face and figure. He was born in 1802; married, in February, 1825, Murilla Hulburt, of Cornwall, Connecticut, and died December, 1856, as result of an injury from a piece of falling cornice at a fire in Elmira, near the Lake street bridge. He was collector of customs, and at one time held a department position in Washington.

Judge James Dunn, the youngest son of William Dunn, gave promise from early manhood of becoming one of the notable men of the county. He was educated in the public school and about 1822 began the study of law with Aaron Konkle. He was admitted to the bar of Chemung county in 1825 and was subsequently a member of the law firms, North & Dunn, Dunn & Hathaway and Dunn & Patterson. He was the second elected "First Judge" of Chemung county, serving from 1844 to 1846. In his prime he was looked upon as possessing a strong legal mind, and was numbered with the ablest men of his profession. He measured swords with many of the brightest lawyers of his day and won many notable legal battles. In 1840 he was the candidate of the Whig party for Congress, but the district being strongly Democratic, he was defeated. For many years he was the acknowledged leader of the Whigs in Chemung county, having for his trusted friends such men as

Seward, Weed, Greeley, Charles Cook, John C. Clark and others. In 1848 Judge Dunn supported the candidacy of his old time antagonist, Martin Van Buren, for the presidency, "bolting" his own party ticket in favor of the Free Soil Democrat. In 1852 he supported General Scott and became an earnest, active Republican, holding extremely radical views on the slavery question. During the stormy reconstruction days he acted with the Democratic party, although his last vote was for President Hayes. He died May 1, 1877. The resolutions of respect from the Chemung county bar tell of the high esteem in which he was held. Said Ariel Thurston at a meeting of the bar held May 3, 1877, "At the time of his death Judge Dunn was with one exception the oldest member of the bar within the limits of the old county of Tioga. He was too, I believe, the oldest native born citizen of the city, Elmira, residing within its limits. He was most genial and companionable in his manners, somewhat sarcastic; a man of broad humor and quick repartee; always enjoying a joke and with his friend, James Robinson, was often wont to set the table in a roar. In the argument of a legal proposition, he was by no means an antagonist to be trifled with."

Judge Dunn married, April 28, 1827, Eliza Thompson, of Goshen, Connecticut. Just three days prior to the death of Judge Dunn, they celebrated their golden wedding. Eliza Thompson, Arthur Dunn's grandmother, was a daughter of General David Thompson, of the War of 1812, a lineal descendant of Anthony Thompson, who commanded the "Good Ship Hector" which landed at New Haven in 1637. Anthony Thompson was a son of Henry Thompson, Gentleman, married to Bertha Honeywood, sister of Sir Robert Honeywood, who left her by his will Lenham Manor, Kent, England. This branch of the Thompson family traces its lineage back directly to William the Conqueror and Charlemagne. Among the Thompson Connecticut ancestors were a chief justice of the state of Connecticut and a chief justice of the United States. Judge James Dunn was survived by his widow and sons, D. Thompson, Henry and Isaac B., the two former then residents of the state of Georgia. He also left two daughters, wives of Frank H. Atkinson, of Elmira, and Thomas Root, of Philadelphia.

Isaac B. Dunn, son of Judge James Dunn, was born in Elmira, New York, in 1846. He was educated in the public schools. He entered the public service of his country, was examiner of pensions and remained in government position until his death. He was a member of the Presbyterian church, and fraternally a member of the Masonic Order. He married Georgianna Frances Tatham, daughter of John Tatham, of English ancestry, his family being early settlers in Virginia. Three children grew to years of maturity: 1. John T., born July 10, 1869, graduate of Princeton University, class of 1892, graduate of Princeton Theological Seminary, class of 1896; he subsequently read law with his brother, Arthur Dunn, and was admitted to the bar of Lackawanna county in March, 1900; he is now partner of the law firm, Dunn & Dunn, vice-president and secretary of the Scranton Real Estate Company and vice-president of the Fidelity Mortgage and Securities Company. 2. Eliza, married Dr. William Carver Williams, of Chicago. 3. Arthur, of whom further.

Arthur Dunn, youngest son of Isaac B. and Georgianna Frances (Tatham) Dunn, was born in Elmira, New York, March 7, 1873. He grew to youthful manhood in Elmira, obtaining his preparatory education in the public schools. He then entered Princeton University, whence he was graduated, class of 1895. He then came to Scranton, where for one year he taught school, having also registered as a law student in the office of Judge Alfred Hand. He was admitted to the Lackawanna county bar in September, 1897, and has

attained high position as a lawyer of learning and skill. For three years he practiced in Scranton alone, but in 1900 admitted his brother, John T. Dunn, under the firm name, Dunn & Dunn, with offices in the Scranton Real Estate Building. Arthur Dunn was counsel in the noted case of Bishop Hoban versus The Greek Catholic Church, and has participated in many important legal controversies. The firm made a specialty of corporation law, and it has been instrumental in the organizing and financing of eleven important corporations of Scranton and its vicinity, also ten other large corporations in other localities. These include the People's National Bank, the Anthracite Trust Company, the Providence Bank, the First National Bank of Factoryville, the Luzerne National Bank, the Black Diamond Silk Company, the Scranton Real Estate Company, the Fidelity Mortgage and Securities Company and others outside of Scranton. He is also president of both the Scranton Real Estate Company and of the Fidelity Securities Company, both institutions of high standing and great usefulness. In addition to his large legal practice and financial activities, Mr. Dunn has given much time to the duties of a good citizen. A Republican in politics, he has ever been a leader of the progressive thought of his party, and an earnest advocate of good government regardless of party preference. In 1911 he was chairman of the citizen's committee of fifty, formed to effect needed reforms in the city government. He earnestly advocated the election of Theodore Roosevelt in 1912, took active part in the primaries, and was one of the most effective orators of that famous primary campaign. He sat as a delegate in the Progressive convention at Chicago that nominated Colonel Roosevelt for the presidency, and in the following campaign rendered valiant effective service to the "Bull Moose" cause, as treasurer of the state committee, and "on the stump," being one of the chief orators of that memorable campaign that swung Pennsylvania from her ancient moorings in the Republican haven, and fanned into a fierce flame the spark of independence that had long smoldered in Pennsylvania politics. His advocacy of the Progressive cause was from purely patriotic, unselfish reasons, as Mr. Dunn has never sought or accepted office for himself, although he has been repeatedly urged to accept nominations for both mayor of Scranton and for Congress. He is an active advocate of the cause of woman suffrage, and lent his best effort to secure the passage of an act of legislature, submitting the question to the voters of Pennsylvania.

In the active campaign made by the Scranton Board of Trade, Mr. Dunn was a member and chairman of the committee on membership that increased the roll of members from 267 to 750. Mr. Dunn, as chairman of a committee of Progressives, helped finance and establish the Scranton Daily News. The Progressives of Northeastern Pennsylvania had reason to believe that the editor of the Tribune-Republican was discriminated against in a financial way on account of his Progressive politics resulting in the loss of the Tribune-Republican to its editor and the Progressive party. Mr. Dunn, in conjunction with close friends of Theodore Roosevelt, led a movement of the Progressives to found another newspaper with the same editor at its head. After a bitter and spectacular fight lasting over a year with the financial interests and machine politics on one side and Mr. Dunn and the Progressives on the other, aided by the powerful moral support of Theodore Roosevelt, the paper was successfully financed and established. At the conclusion of the fight which lasted almost a year Mr. Dunn was given a vote of thanks by the Progressive convention at Harrisburg in the spring of 1914.

In addition to his numerous activities Mr. Dunn has found time to do a great deal of traveling and hunting. He has traveled throughout the United States, Canada, West Indies, and has made two trips to Europe. He has canoed, fished and hunted throughout the Maine wilderness and parts of

Canada. He has fished and hunted extensively in the Rocky Mountains, and has at his home many trophies of the chase. He has also presented the Scranton Club, Young Men's Christian Association and others with mounted moose and elk heads. In religious faith Mr. Dunn is a Presbyterian, belonging to the Green Ridge congregation, his family also being communicants of that church.

Arthur Dunn married, December 21, 1897, Augusta Pratt, daughter of Dr. Jeremiah L. Fordham, of Scranton; children: Arthur Jr., John Fordham, Adelaide Augusta, Walter Bruce, Virginia Frances. The family city home is at the Hotel Casey; their country residence includes a beautiful farm of eighty acres in Waverly, devoted to fruit culture and poultry raising.

---

### EUGENE SCHIMPPFF

A lifelong resident of Scranton, although temporarily residing in other cities, Mr. Schimpff has since 1886 been one of the active merchants of his native city, where he is now located at No. 428 Spruce street, one of the prosperous jewelers of the city. His father, Jacob Schimpff, established the second bakery in the city in 1860, on then Ward street, now Cedar avenue.

(II) Jacob Schimpff, son of Philip Schimpff, was born in Landau, Germany, in 1806, there was educated, learned the baking business, in which he was engaged until 1860, then immigrated to the United States. He settled in Scranton the same year and at once established a bakery, continuing in business until his death. He married Caroline, daughter of Phillip Robinson, and had issue: Leopold, died in 1888; Mina, married Phillip Robinson, of Scranton; Mary, married Peter Gunster, of Scranton, Mr. Gunster now deceased, Mrs. Gunster now living in Los Angeles, California; Robert, died in 1888; Eugene, of whom further; Caroline, married George Lohmann, of Wilkes-Barre, Pennsylvania; Elizabeth, deceased; Jacob, deceased; August, resides in Scranton; Carl, living in Scranton.

(III) Eugene Schimpff, third son of Jacob and Caroline (Robinson) Schimpff, was born in Lauterecken, Germany, November 27, 1853. He was seven years of age when the family came to the United States. He was educated in the public schools and after finishing his studies became his father's assistant in the bakery. After the death of his mother he entered the employ of Phillip Robinson, his uncle. During this period Mr. Schimpff worked endlessly, using every effort to advance himself, and after many hard struggles, thrown upon his own resources, he started to learn the trade of watchmaker and jeweler, working without pay for thirteen months, when he went to New York City and there entered the employ of M. L. Sheehan, jeweler and watchmaker; he continued with Mr. Sheehan for a period of four years, becoming a master in his line, and after another two years in New York, owing to failing health, Mr. Schimpff returned to Pennsylvania, locating at Wilkes-Barre, where in partnership, he conducted a restaurant for two years, under the firm name Schimpff & Lohmann. In 1880 he again returned to Scranton and began his long connection with the jewelry business in this city. He opened his first store on Wyoming avenue, near the present Jermyn Hotel. He next moved to No. 319 Lackawanna avenue. He was not satisfied with the location, however, and moved to No. 313 Lackawanna avenue. Here he prospered exceedingly, and finding his quarters too small moved to his present location, No. 428 Spruce street, where he has built up a large and prosperous business along general jewelry store lines. He has been successful in an unusual degree, conducting his business personally, dealing with fairness to all, and holding to the strictest principles of integrity. He has attained honorable

position in the business world, not by special favor, but by his own energy, ability, progressiveness, and thorough knowledge of his business. He owns a farm of eighty acres where he raises Ayrshire cows imported from Scotland, also Chester white pigs, and fruits at Mt. Cobb on Moosic Mountain. He is interested in Soroco Mining and Milling Company, mines located in New Mexico, owning and operating the Little Fanny Mine, the Pacific Mine, the Johnson group of claims, and several others which are now in successful operation, yielding excellent return.

Mr. Schimpff married Margaret, daughter of Casper Tanler. Children: Leopold, Martha, Eugene, Laura, Walter, Robert, Helen.

---

#### FRED C. HANYEN

A lawyer of recognized standing in the city of Scranton, prominent in fraternal relations throughout the state, and identified in close connection with religious work in this city, Fred C. Hanyen is a gentleman of widely varied interests and far-reaching influence. He came to Scranton after an extensive experience in educational work, and in that city has conducted his legal practice to which he devotes his entire time. A member of the Independent Order of Odd Fellows, that order has honored him with many of the distinctions within the gift of the society, and in deed and reputation he is an ornament to Odd Fellowship, with whose principles he is in such entire accord.

Mr. Hanyen is a native of New York state, and is a son of Cornelius and Jennie E. (Reynolds) Hanyen. Cornelius Hanyen was born December 8, 1834, died September 23, 1913. His early boyhood was spent upon a farm. At the age of nine years he began work upon the Delaware & Hudson canal where he remained for several years. Leaving the canal, he learned the carpenter's trade, at which he worked until 1855, when he purchased and operated a boat on the Morris canal between Penn Haven and New York City. In 1856 he sold this interest in the canal boat and secured a position as master carpenter in the Chicago and Rock Island Railroad. Later entering the business of contractor and builder in the middle west, he subsequently returned east, and after serving as clerk in the store of B. Turner & Company, of Eddyville, Ulster county, New York, and later in the store of R. C. Lockwood, of Wellsburg, New York, he opened a grocery store in the city of Elmira. Subsequently he formed a partnership with Charles Frear under the firm name of Hanyen & Frear, later the firm became Hevener & Hanyen, and finally Mr. Hanyen became sole proprietor. His business here flourished to such an extent that he became the leading grocer of the place. Failing health caused him to move to Mosherville, Pennsylvania, where, purchasing a general store, he conducted the same for one year, the following year moving to Rutland, and there in 1880 acquiring title to a general store which he conducted until his death. Mr. Hanyen prospered as a merchant, despite the fact that twice during his business career his establishment was burned with a total loss. He was a justice of the peace and for twenty years held the office of postmaster at Rutland. His church was the Methodist Episcopal, in whose works he was always active. He held membership in the Independent Order of Odd Fellows, and was also a thirty-second degree Mason. Children of Cornelius and Jennie E. (Reynolds) Hanyen: Fred C., of whom further; Louise, a teacher in the public schools of Elmira, New York; Cole B., supervising principal of the public schools of Dorranceton, Pennsylvania; J. Blanche, married Louis M. Parker, assistant cashier of the First National Bank of Mansfield, Pennsylvania, and has one daughter, Harriet Louis.

Fred C. Hanyen was born in Elmira, New York, December 15, 1864. He



was given opportunities for a generous education, which he embraced, graduating from the Mansfield State Normal School in 1886. He also became a student in New York University, later attending the Post-Graduate College. After teaching in Rutland and Jobs Corners, he became in 1888 principal of the public school at Clarks Green, Pennsylvania, holding that position for two years and then returning home and entering business with his father. He was subsequently appointed to the principalship of the Waverly High School, then Madison Academy, and remained at its head until April 30, 1901. During the time he was teaching at Waverly he studied law, registering in the office of Hueslander & Vosburg, of Scranton, and was admitted to the bar of Lackawanna county in September, 1897, since which time he has been in constant practice in all of the state and federal courts of his district, the superior and supreme courts. His professional brethren recognize him as an attorney of honor and integrity, and of ability that has been tested in opposition at the bar, through which respect for his legal talents has been engendered. Mr. Hanyen has business as well as professional relations, and is a director of the Abington National Bank and a director and secretary of the Abington Electric Company.

Mr. Hanyen's fraternal affiliation is with but two orders: The Masonic and the Odd Fellows. In the former he belongs to Peter Williamson Lodge, No. 323, F. and A. M., while in the latter society he has won high station. He is a member of Electric Star Lodge, No. 490, I. O. O. F., and has passed the chairs of the subordinate lodges as well as those of the Grand Lodge, and is now a past grand master of the Grand Lodge of Pennsylvania, Independent Order of Odd Fellows. All activities of the order have benefited by his interest and participation therein, and the honors that have come to him are the rewards of service, the mark of the esteem of his fellows. For many years he was the representative of the Grand Lodge to the Odd Fellows' Orphanage, several miles east of Sunbury, and at the present time he fills the office of first vice-president of the Home. At this place one hundred and fifty boys and girls are trained and schooled for honorable station in life, and Mr. Hanyen's active part in the management of this institution shows the deep sympathy of the humanitarian. His church is the Elm Park Methodist Episcopal, and for twelve years he has been teacher of an adult Bible class in the Sunday school of this church, in which capacity he has strengthened his stand as a champion and supporter of all the best influences and forces whose aim is to create and maintain a higher plane of civil morals. Mr. Hanyen is a gentleman in whom the realization of the duties of citizenship is keenly awake, and in that line his value to the city of Scranton lies.

Mr. Hanyen married Minnie E., daughter of M. S. and Priscilla (Lee) Roberts. Mr. and Mrs. Hanyen are the parents of: Mildred L., Jennie M., Howard Ray.

---

#### DR. ALEXANDER J. CONNELL

Through Dr. Alexander J. Connell, the name has become prominent in the medical profession of Pennsylvania, as through his cousins, uncle, and father, it has become synonymous with honor, integrity and ability in the industrial and financial world of the commonwealth.

James Connell, father of Dr. Alexander J. Connell, was born in Prince Edward Island, a province of Canada, lying in the Gulf of St. Lawrence. He died in 1877, aged fifty-six years. James Connell, when a young man, was employed in the mines at Hazelton, Pennsylvania; in 1855 he came to Scranton and was there placed in charge of the Davis Colliery. Forming a partnership with his brother William, they purchased the Meadowbrook mines, later

acquiring the National and Minooka properties. Throughout his entire life he engaged in mining operations and while the meed of prosperity granted his brother was withheld from him, he was nevertheless moderately successful. Being an experienced miner, his duties were always connected with the practical and not the financial side of the business. He married Jessie, daughter of John English, and had ten children, of whom four are living.

Dr. Alexander J. Connell, born in Scranton, Pennsylvania, September 18, 1856, was one of the first students in old "Daddy Merrill's" school, and later attended Scranton High School. His academic studies were completed at Wyoming Seminary, whence he was graduated in 1873. His professional education was obtained at the Bellevue Hospital Medical College, New York, where he obtained his degree of M. D. in 1877. He then served for a time in Bellevue Hospital. He began the practice of his profession, locating in Scranton, where his learning and ability received their just reward in the wide practice which his early efforts attracted. In 1909, feeling that his continued close attention to the manifold duties of his calling had earned a much needed vacation, he spent several months touring Europe, visiting the most famous educational seats of his profession, including Berlin, Paris, Vienna and London.

Besides his influential and lucrative private practice he has been the consulting surgeon of the Moses Taylor Hospital ever since its organization, and for twenty-five years, until his resignation, was surgeon of the Lackawanna Hospital, later became consulting surgeon and on the board of directors. He served as trustee of the State Asylum for the Insane at Danville. Dr. Connell's skill in surgical matters equals his knowledge of medical properties and their administration; his every action in the operating room suggests a clear and decisive purpose, and inspires confidence in all his assistants. In the most critical periods of a trying operation his nerves are as steady as when he is treating a patient for the slightest ailment, while at the side of a sick bed his very presence lends hope and comfort to the anxious watchers. He has been president of the County Medical Association, and a member of the State and American Medical associations. Dr. Connell is also prominently associated with many of Scranton's most successful business organizations, being president of the Northern Electric Railway, vice-president and medical director of the Scranton Life Insurance Company, director of the Enterprise Coal Company, director of the Green Ridge Coal Company, and director of the National Limestone Company.

He joined Company K, Thirteenth Regiment Pennsylvania National Guard, at the time of its organization and was a member of the same for ten years, five of which were spent in the medical corps, where he gained the rank of first lieutenant. Fraternally Dr. Connell is affiliated with the Masonic Order, belonging to Peter Williamson Lodge, Free and Accepted Masons, Coeur de Lion Commandery, Knights Templar; Keystone Consistory, Sovereign Princes of the Royal Secret, thirty-second degree, Ancient Accepted Scottish Rite, and Irem Temple, Nobles of the Mystic Shrine. Socially and in the club life of Scranton, Dr. Connell is active and prominent, being president of the Scranton Club and a member of the Country Club and of the Scranton Bicycle Club. With his wife he is a member of the Elm Park Methodist Episcopal Church.

Dr. Connell is a decidedly representative type of our modern physician, entirely professional, but not to the exclusion of all other interests and activities. Aside from the fame he has achieved in the healer's art, he would, among business men, be considered a success, and did his station in life demand nothing but a pleasant passing of time, his social attributes would en-



*- G. L. Small -*



able him to do that very enjoyably. He is, however, the alert and forceful man of affairs, the quietly dignified professional light, and the attractively graceful clubman, the whole forming a most likeable and engaging American gentleman.

Dr. Connell married Fannie M., daughter of Norman Norton, of Scranton. Children: Edgar W., superintendent of the Enterprise Coal Company of Shamokin, and Margaret E., married Benjamin H. Throop.

---

### JOHN IRA RIEGEL

The Riegels, who trace their lineage back to the collapse of the empire of Charlemagne, when an ancestor from the ancient Saxon duchy of Westphalia redeemed Rothenburg on the Tauber, Bavaria, from the house of Hohenlohe and was given that city as an hereditary fief, date in Pennsylvania from September 23, 1732, when Matthias Riegel emigrated from the Palatinate to Philadelphia and settled at Germantown. Philadelphia remained the family seat for several generations, through the Revolutionary War, in which his son Benjamin gave most of his means derived from his estate "Good Intent" in Bucks county to the colonial army at Valley Forge, and on December 1, 1778, gave his life in the cause of American liberty.

The grandson of the latter, Samuel Riegel, who was the grandfather of John Ira Riegel, after a time spent as a merchant in Philadelphia, moved to Easton, Pennsylvania, where he resided until his death. His wife was Mary, daughter of Major Isaac Stout, a veteran of the War of 1812, whose father served as major in the American army of the Revolution, and whose son was a surgeon in the Civil War. Children: Isaac M., of further mention; Eliza, Anna, Dorsey G., Emma, deceased; George S., of Bethlehem; Ada, Charles H., Kate, of Easton.

Isaac M. Riegel was born in Easton, Pennsylvania, April, 1844. He spent a large portion of his business life engaged in lumbering and iron-mining, operating in Pennsylvania and northern Indiana. After retiring from that business he entered the employ of the Bethlehem Iron Company (now Bethlehem Steel Company) under John Fritz as superintendent of construction forces on the plant. He is yet a resident of Bethlehem. He married Sarah E., daughter of Peter Hager and Margaret Rapp, the latter a great-granddaughter of George Rapp, of Wurtemberg, Germany, founder with his brother Frederick of the religious sect of "Harmonists," properly the "Economite Society." Children: John Ira, of whom further; Samuel Stewart, the mechanical engineer of the motive department of the Delaware, Lackawanna & Western Railroad; Susan M., married Alvin S. Gruver, principal of the Bethlehem High School; Marie V., married W. D. Hemmerly, efficiency engineer for the Acme Wire Company of New Haven, Connecticut.

John Ira Riegel was born at Bethlehem, Pennsylvania, July 1, 1871. He was educated in the public schools of Bethlehem, Riegelsville Academy, Bethlehem Preparatory School and Lehigh University, being a graduate of the latter, class of 1892, receiving the degree of Civil Engineer. After leaving the University he spent one year as statistician for the Lehigh Valley Coal Company, and then was appointed to the engineering department of the Lehigh Valley Railroad Company, where in 1897 he was appointed chief designing engineer in charge of all new construction on the lines. In 1899 he severed his connection with the Lehigh to become chief designing engineer for the New York Central Railroad Company, later being promoted to engineer of construction for all reconstruction and new work on the New York Central lines between New York and Albany. In 1901 he resigned his position to

become division engineer upon half the mileage of the Delaware, Lackawanna & Western Railroad, originating there many of the plans for the improvement of that road which have since characterized the "Lackawanna;" and following that made plans and estimates for the Northern Electric Railway, now the Scranton & Binghamton Railway Company, a road designed to connect by interurban railroad the cities of Scranton, Pennsylvania, and Binghamton, New York. In 1903 he became assistant chief engineer of the Delaware & Hudson Company, holding that position until 1909, and during that incumbency four-tracked the line between Scranton and Carbondale, practically rebuilding the entire line, and constructed the new connection with the Pennsylvania Railroad in South Wilkes-Barre for the former company. He then entered the employ of the General Electric Company as chief civil engineer, planning and beginning construction of the new plant at Erie, Pennsylvania, ultimately to cost \$25,000,000. He then retired from active connection with all corporations and established in Scranton as manager and consulting engineer for the Scranton Engineering Company, doing work for individuals, municipalities and corporations. The work he has adopted as his specialty Mr. Riegel is eminently qualified for, and there is no detail of constructive engineering, estimating, appraising, or planning he is not prepared to satisfactorily perform, whether it be corporate, municipal or private. In sanitary engineering he is a specialist, and all phases of modern city needs, sewage disposal, water supply, parks, streets and town planning, have been the object of special study and experience. In his capacity as consulting engineer to the Mine Cave Commission of Scranton he prepared maps showing in complete detail the conditions beneath the city, and giving a perfect basis upon which the Commission could report reliably. In 1912 Mr. Riegel was appointed assistant engineer in the State Highway Department with offices in Scranton, and in that capacity has supervised the betterment of seven hundred miles of miserable roads, placing them in commendable condition; and has also surveyed, planned and built many miles of new roads. He resigned that position in 1914 to resume his private practice, and now is engaged, among other important work, as consulting and designing engineer for the Delaware & Hudson Company on the elimination of the grade crossings of that company in Scranton.

Fairly at the head of his profession, Mr. Riegel, still a young man, has many years of usefulness before him, and it is hoped, abundant opportunity to exercise his peculiar fitness in the public behalf. As a constructive engineer he has no superiors in his own field, and in point of actual achievement he has many monuments extant to his engineering ability. He is a member of the Western Railroad Club, the American Road Builders' Association, the Engineering Society of Northeastern Pennsylvania, the North Eastern Pennsylvania Lehigh Club, and the Scranton Board of Trade. Coming of a family of politicians, preachers and teachers, and knowing the vicissitudes of parties, he is strictly independent in political action for the common good. For the past twenty years he has devoted his leisure in searching out the political history comprising most of the New Testament writings and, with a scholarly Scrantonian as collaborator, has nearly ready for publication a book identifying the makers of that history.

Mr. Riegel married, June 10, 1896, Nellie M., daughter of William B. Ivins, of Princeton, New Jersey, and since 1901 has made Scranton his residence. Children: John Kenneth, born in 1898, and Leda Pauline, born in 1903.

## J. FOSTER HILL

It has been in pursuance of its unchanging policy of securing none but the best and most able of instructors in its different departments that the International Correspondence Schools, of Scranton, secured the services of J. Foster Hill, who for the past six years has been identified with that institution, three years of that time in his present position. A teacher trained for the calling, rendered efficient by several years of practical experience in the school room, his capacity enlarged and usefulness heightened by an art and science course in Harvard University, and after that associated with a number of leading educational enterprises, Mr. Hill was accompanied to the post he now occupies by a record of successful educational endeavor, the results of his work showing plainly the thoroughness and ability with which he wrought.

(I) The Hill family was settled in Pennsylvania by natives of Maryland, representatives thereof settling on Broad Top Mountain, Bedford county. In 1844 Jacob Hill, grandfather of J. Foster Hill, moved to Indiana county, Pennsylvania, there purchasing a tract of wooded land, clearing the same and conducting farming operations during the remainder of his active life. The homestead has remained in the possession of the family. Jacob Hill married Rebecca Kelley, of Broad Top Mountain, Pennsylvania. They had children: Susanna, died in 1913, married William Fleming, of Creek Side, Pennsylvania; Barbara, married Jacob Blough, of Johnstown, Pennsylvania, her husband deceased; Mary, married Jefferson Palmer, of Indiana county, Pennsylvania; Martha, married Finley Carney, of Indiana, Pennsylvania; David, married Elizabeth Fleming, both deceased; John, died in 1909; Andrew Jackson, of whom further.

(II) Andrew Jackson Hill, son of Jacob and Rebecca (Kelley) Hill, was born November 12, 1833, died January 18, 1887. He married Elizabeth, daughter of Frederick Stuller, of German descent, and had children: Mary Magdalene, married John Hancock, of Pittsburgh, Pennsylvania, and is the mother of one child, Geraldine; Rebecca Ann, deceased; J. Foster, of whom further; Frederick Austin, married Mary Pierce, and has children, Elizabeth, Mary, Foster, Geraldine, Burrell, George Milligan, John Martin.

(III) J. Foster Hill, son of Andrew Jackson and Elizabeth (Stuller) Hill, was born at Creek Side, Indiana county, Pennsylvania, November 25, 1864. His public school education was obtained in White township School No. 5, and West Pike School near Indiana, after which he attended the Indiana State Normal School, in 1890 entering Clark's Business College, whence he was graduated, valedictorian of his class. For the four following years Mr. Hill taught the commercial branches in the same school, one year and a half of that time holding the principalship of the commercial department, and in the fall of 1895 matriculated at Harvard University. Although he was unable to continue his course uninterruptedly, being absent from the university for two years, he received his A. B. degree in 1902. While a student of Harvard Mr. Hill organized the night school in the Cambridge Young Men's Christian Association, and after this enterprise had been successfully inaugurated remained in the Association as director of the educational department for eight years, in April, 1903, coming to Scranton. Here he repeated his Cambridge performance in the organization of a night school in the Young Men's Christian Association, remaining in the school as educational director for three years after the inception of the undertaking. From 1905 to 1908 Mr. Hill was instructor in science and mathematics in the School of the Lackawanna, in October of the latter year accepting the principalship of the School of Mathematics and Mechanics in the International Correspondence Schools of this

city. His services as the head of this branch of the International system were eminently satisfactory, and on January 1, 1911, a broader field for his talents and natural endowments opened before him in his appointment to the principalship of the Department for the Encouragement and Assistance of Students of the institution. The value to a Correspondence School of such a department, whose name explains its mission, when directed by a man such as Mr. Hill, who has been the familiar friend and adviser of hundreds of students, cannot be over-estimated.

Mr. Hill married, June 22, 1898, Margaret Elizabeth Frater, of Erie, Pennsylvania, daughter of Robert William and Anna (Baxter) Frater, of Crewe, England. Mr. and Mrs. Hill are the parents of: Gladys Frater, deceased; Eliot Russell, born October 3, 1900; Mildred Elizabeth, born July 23, 1903; Eleanor Anna, born November 23, 1906. Mr. Hill holds membership in the Scranton Board of Trade. Politically he is a Prohibitionist, and he is a member of the Second Presbyterian Church of Scranton.

---

#### GEORGE R. CLARK

For considerably more than a century the Clarks have been residents of the Abington section of this part of Pennsylvania, and as farmers, horticulturists and florists have made the soil respond to their skillful manipulation. One of the benefits resulting from the coming of this, one of the oldest New England families to Pennsylvania, was the propagation of the Clark apple, which began with a seed planted near the log cabin of William Clark. This seed he brought with him from Connecticut in 1798. From it sprang the tree from which the Clark apple was propagated and which survived storm and sunshine until 1910, after furnishing fruit and shade for over a century. The scions which were obtained from this mother tree have been grafted on trees throughout northeastern Pennsylvania, and as a result thousands of bushels of these Clark apples have been grown. The variety is still greatly sought after and is very popular with fruit growers. William Clark, after a visit to this section of Pennsylvania in 1792 and choosing a location, came in 1798 from his Connecticut home and settled at Abington, one of the original pioneers. He was then a married man with a family whom he housed in a log cabin. They passed through all the trials and privations ever the lot of the pioneer, but true to their New England traditions plowed, sowed and reaped, made maple sugar in the big iron kettle brought from Connecticut, and started an orchard from the apple seeds brought from the old home. They were of the true Puritan stock and the first religious meeting held north of the mountains was at the house of Deacon William Clark, who was a member of the Baptist church.

(II) George Clark, son of Deacon William Clark, was born in Connecticut, and came with the family to Abington in 1798. He grew to manhood near Clarks Green, named in honor of the family, lived at what became later South Abington, but in comparatively early life moved to Waverly. He was engaged in the business of an agriculturist all his life, a prosperous man and respected citizen.

(III) James R. Clark, son of George Clark, was born in Abington township in 1826, and died in Scranton aged eighty-two years. He was a farmer for many years until 1880, then moved to Scranton, that city ever afterward being his home. He was a member of Waverly Lodge, Free and Accepted Masons, and of the Methodist Episcopal church. He married Parma La Bar.

(IV) George R. Clark, son of James R. and Parma (La Bar) Clark, was born at Waverly, Abington township, September 7, 1854. He was educated



in the public school and Madison Academy, the latter a school of high character in that day. He grew to manhood at the home farm and became thoroughly imbued with a love of nature and a true spirit of admiration, even veneration, for the wonders the seasons accomplished on bush, tree, plant and flower. He was passionately fond of flowers and gave a great deal of time to their culture and to a study of their individual characteristics. In 1878 he gave himself up entirely to floriculture, forming a partnership with Judson Tinkham, as Tinkham & Clark, the first florists to do business in this section of Pennsylvania. Later Mr. Clark bought his partner out and has since conducted the business under his own name at No. 124 Washington avenue, Scranton, the oldest florist in the city. For many years he raised on his own farm the flowers, nursery stock and seeds he sold, but as trade expanded until it now covers northeastern Pennsylvania, he was obliged to increase his sources of supply. His seed department added in 1898, is an important one, as is his trade in commercial fertilizers. He has also an aviary and aquarium, singing canaries and fancy gold fish, being his specialties. He is an artistic and much sought for decorator, while the quality of his nursery stock has long been acknowledged by fruit growers. Most successful as a business man and fully immersed in its cares, Mr. Clark is still the lover of nature and her works and sentimentally is fonder of the flowers, plants and trees he handles than of the gain they may bring him. He is a director of the Scranton Young Men's Christian Association, director of the City Rescue Mission, member, trustee and school superintendent of the Court Street Methodist Episcopal Church, a loyal worker and a man in whom perfect confidence is reposed. He has taken high degree in the Masonic Order, belonging to Peter Williamson Lodge, Free and Accepted Masons; Lackawanna Chapter, Royal Arch Masons; Coeur de Lion Commandery, Knights Templar; Irem Temple, Nobles of the Mystic Shrine and to the various bodies of Keystone Consistory, Ancient Accepted Scottish Rite, in which he holds the thirty-second degree.

Mr. Clark married (first) Clara K. Kennedy, who died, leaving two children: Ethel G., wife of Clinton W. Tylee, of Worcester, Massachusetts, and G. Ronald, formerly of Hartford, Connecticut, now of Portland, Maine. He married (second) Elizabeth G. Mumford. Children: Francis Gerold and La Bar Hastings.

---

#### HARRY VAN NUYS LOGAN, M. D.

Harry Van Nuys Logan, M. D., eldest son of Rev. Samuel C. Logan, D. D., LL. D., was born in Constantine, Michigan, May 21, 1853. He graduated from Lafayette College and studied medicine and surgery at the University of Pennsylvania, graduating with the degree of M. D. He began the practice of medicine in Scranton, Pennsylvania, and achieved immediate distinction and marked success. He joined the Scranton City Guard at its organization in 1877, and in 1880 was appointed assistant surgeon of the Thirteenth Regiment National Guard of Pennsylvania with the rank of first lieutenant. In 1883 he was promoted to be surgeon of that regiment with the rank of major, which position he held with distinction until 1886, when the demands of his private practice compelled his resignation.

He married Mary Olmstead, daughter of Richard W. and Sarah S. Olmstead, December 29, 1881. There were born to them the following children. May W., Harry A., Lucie L., Richard W.

Dr. Harry Logan, as he was popularly known, came to Scranton with his father's family, in 1868, when his father was called to the pastorate of the First Presbyterian Church. He was a lad in his teens at that time and prac

tically grew up with our young city. As a boy and young man he was justly popular with all classes. His professional attainments were acknowledged by a large clientele, and he gave freely of his skill and time to hospital work and attendance among the suffering poor. He was an indefatigable worker, a slave to his profession, which finally undermined a vigorous constitution and caused his much lamented demise, while still a young man. He passed away July 13, 1911.

---

#### GUSTAV FRANK RENNER

Gustav F. Renner, superintendent of the weaving department of the Sauquoit Silk Mills of Scranton, Pennsylvania, after a varied career, has become the incumbent of a responsible office in that organization, a position for which he is fitted by inherent talent, specialized education, diverse experience and natural attraction, his part in the practical management and supervision of these mills being an important factor in their present prosperity and local prestige. He is German in descent and in birth, Schoeneck, Saxony, Germany, having been the place of birth of his father in 1826.

Frank William Renner, father of Gustav F. Renner, was educated in Germany and there learned the weaver's trade, becoming expert in his chosen art, and when past middle age immigrated to the United States, ten years after his son had come, and for a time resided in Wilkes-Barre, Pennsylvania; he then came to Scranton where he obtained employment in the Sauquoit Silk Mills, remaining with that concern until his retirement in 1903, his death occurring ten years later. He married Wilhemina Keil, and had one child, Gustav Frank, of whom further.

Gustav Frank Renner, son of Frank William and Wilhemina (Keil) Renner, was born at Schoeneck, Saxony, Germany, August 12, 1859, and obtained a general education in the public and high school of his native city. He then entered the Textile School at Glauchau, Germany, and in the two years that he was a student in that institution became a learned and skilled operator, and accepted employment in the textile mills in Germany, there being employed until his determination to come to the United States, whither he preceded his father, taking passage on the North German Lloyd liner, "Donau." After landing in New York he obtained work in a blacksmith shop. After a short time he continued his journey and stopped in Philadelphia, Pennsylvania, where he was employed in a grocery store for four months at a wage of one dollar a week. During this time he saved, in some extraordinary manner, fourteen of the sixteen dollars he received, in 1882 being engaged as a weaver in a Philadelphia mill. On March 1, 1883, he left Philadelphia and went to Scranton, there finding employment as a loom fixer in the Sauquoit Silk Mills, and there remaining for three years. At the end of that time he purchased a horse and wagon and went into the produce business, buying his truck from the farmers in the outlying country and disposing of them on the day of purchase, so that his customers, the list of whom steadily increased, were assured of fresh goods. After a year passed in this manner he sold his business and returned to Philadelphia, being there engaged in sewing machine repair work. Still further retracing his steps, he went to New York, and was there a loom fixer for a short time, soon crossing over into New Jersey and becoming a weaver in the mills of Paterson, the center of the silk manufacturing industry in the United States. Then, after a short term of employment in Wilkes-Barre with Mr. Goldsmith, he came to Scranton in December, 1889, once more entering the Sauquoit Silk Mills, with which he has since been connected, having entire charge of the weaving department of the mills, where his authority is absolute.

To his practical and technical knowledge and experience Mr. Renner has added an innate ability in dealing with men, and the lubricity apparent in the department of which he is head shows that the utmost harmony and satisfaction pervade that division of the business. Outside of the path of his business interests he is accepted in many circles as a genial companion, having an attractive personality, and a gentleman whose presence adds to any gathering. Fraternally he is a member of Shiller Lodge, No. 345, F. and A. M., also holding the Knights Templar degree in the Masonic Order, and a member of the Benevolent and Protective Order of Elks. He is also a member of Scranton Liederkrantz, the Junger Mannerchor, and the German Alliance, his political stand being an independent one.

Mr. Renner married, in 1887, Emma Mursch, of Scranton. Children: William and Carl, employees of the silk mills in which their father is engaged; Minnie; Gustav, an employee of the Sauquoit Silk Mills; Fritz, a student in a military school; Amelia, deceased.

#### ASA EVERETT KIEFER

Northampton county, Pennsylvania, has been the home of several generations of the family of Kiefer claiming Asa Everett Kiefer, of Scranton, as a member. Casper Kiefer, the American progenitor of this branch of the Kiefer family, was born in Strassburg, Germany, in 1710, emigrated to America, and arrived at Philadelphia, September 15, 1748. He came with his brother, Abram Kiefer Jr., in the ship "Two Brothers," Captain Thomas Arnott, from Portsmouth, England, having originally started from Rotterdam, Holland. He removed to Saucon township, Northampton county, Pennsylvania, where he died.

(II) Peter Kiefer, son of Casper Kiefer, was born in Saucon township, in 1756, died in Lower Mount Bethel township, November 2, 1846. He served in the American army during the Revolutionary War. He married Catherine Engleman, and had child, Samuel, of further mention.

(III) Samuel Kiefer, son of Peter and Catherine (Engleman) Kiefer, was born in Saucon township, in 1790, died in February, 1865. He became a farmer at Lower Mount Bethel, and followed this calling all his life. In the second war with Great Britain he became a member of the Northampton Light Guards, and remained with that company until it was mustered out of service. His remains are interred near his home at Three Churches. Mr. Kiefer married Sarah Everett, born at Upper Mount Bethel, Pennsylvania, died at the age of fifty-five years, a daughter of William Everett, whose father was an officer in the American army during the Revolutionary War. Children: 1. Catherine Ann, married Azariah Stocker, and had children: i. Sarah, married Theodore Ackerman, and had children: Eulalie, married Rev. W. H. Wells, had one child, Esther; Eugene, married Martha Rosenberg, had a child, Anna; Lina Stocker. ii. Mary, married John Pursell, and had one child, William, now a physician. iii. Eliza, married Edmund Steven Dana, and has children: Herbert Stocker and Edna Kiefer. iv. Herbert. v. Susan, married Preston Billheimer. vi. Lina. 2. Margaret, married George Rodenbough, and had children: i. Margaret, married William Bachman, and had children: Walter Ellsworth, Bertram Rodenbough and Lina C. Kiefer. ii. George. iii. Walter Scott, married Clara Hill. iv. Samuel. v. Elmer Ellsworth, married Elizabeth McChan, and had one child, Margaret McChan. 3. William Everett, born in 1825, married Susan Martin, and had children: i. Sarah Elizabeth. ii. Margaret Rodenbough, married Dr. Frederick Sterling Hewitt, and had one child, Robert Sterling. iii. Joseph Martin,

married Rena E. Van Meter, and had children: William Everett Jr.; Isabel; Ralph Van Meter; Marie. iv. Charles Everett. 4. Caroline, never married. 5. Angeline, twin of Caroline, married Amos Schoonover, of Stroudsburg, Pennsylvania, and had children: i. Laura Goforth, married Oscar E. Peltzer, and had children: Oscar Wesley and Laura. ii. Ethel Caroline, married Arthur Briggs, and has one child, Clifford. 6. Asa Everett, of further mention.

(IV) Asa Everett Kiefer, son of Samuel and Sarah (Everett) Kiefer, was born at Martin's Creek, Northampton county, Pennsylvania, August 10, 1848. After attending the public schools of the place of his birth, and Freeland's Institute, at Collegeville, Pennsylvania, he completed his general studies at Carversville Institute, in Bucks county. For two years he was a school teacher, and after being graduated from the Bryant and Stratton Business College in Philadelphia, he entered the service of the Central Railroad of New Jersey, and was stationed in the office of that road at Elizabethport, New Jersey. Two years later he resigned his position and became associated with the Adams Express Company as extra messenger, remaining with this corporation in different capacities and in different localities for seven and a half years. Coming to Scranton, he was for two years connected with the Bittenbender Company, then spent eleven years in the employ of the Green Ridge Iron Works as bookkeeper and timekeeper. In April, 1892, Mr. Kiefer accepted a position with the Scranton Lace Curtain Company, with which concern he is now associated, his present position being that of superintendent of supplies. His office is one of importance because its administration determines to such a great extent the expense of maintenance of the business, and in this modern day of the highest efficiency in every department of business, sources of direct expenditure are those that are most closely observed. Mr. Kiefer has, for a period of twenty-two years, rendered faithful and competent service to his employers, his activity in his present capacity being no exception to this reputation of long standing.

He is a Republican in politics, and from 1896 to 1902 served as auditor of Laekawanna county, and for two years was a member of the Scranton common council. During these two years he rendered important and beneficial service to the community. He was the first to introduce an ordinance into the common council calling for the placing of gates at all grade crossings, and after a hard and prolonged fight he succeeded in having it put in operation. He was also largely instrumental in having the city hall placed upon its present site, several others having been strongly advocated, and the contention over this point lasted more than a year. He is a charter member of Green Ridge Lodge, No. 603, I. O. O. F., and has been secretary of the lodge. He is a member of the Second Presbyterian Church of Green Ridge.

Mr. Kiefer married Emma B., a daughter of Charles and Malinda (Colbath) Younkin, the former a conductor for the Central Railroad of New Jersey, and a resident of Easton, Pennsylvania. The only child of Mr. and Mrs. Kiefer is Marilla Kemmerer, who was graduated from the Scranton High School in 1897, and married Dr. Ralph H. Spangler, of Philadelphia, and has children: Huston Kiefer, born in 1908; Ralph Dixon, born in April, 1913.

---

#### CHARLES WHITEHEAD KIRKPATRICK

Watties Neach, Dumfriesshire, Scotland, was the birthplace of the American ancestor of Charles Whitehead Kirkpatrick, of Scranton, Alexander Kirkpatrick, who about 1725 emigrated from his native land and found residence in Ireland. In the spring of 1739 he came to this country, taking up land at the



*Asa Everett Kiefer*



place now known as Mine Brook, New Jersey, and there making his home, his death occurring in that locality, June 3, 1758. He was the father of Andrew, David, of whom further; Alexander, Jeannette, Mary.

(II) David Kirkpatrick, son of Alexander Kirkpatrick, was born at Watties Neach, Dumfriesshire, Scotland, February 17, 1724, died at Mine Brook, New Jersey, March 19, 1814. He married, March 31, 1748, Mary McEwen, and they had children: Elizabeth, Alexander, of whom further; Hugh, Andrew, David, Mary, Anne, Jeannette.

(III) Alexander (2) Kirkpatrick, son of David and Mary (McEwen) Kirkpatrick, was born September 3, 1751, died September 24, 1827. He married Sarah, daughter of Judge John Carle, of Long Hill, Morris county, New Jersey. Of their children these attained mature age: David, Mary, John, Jacob, of whom further; Sarah, Elizabeth, Lydia, Ann, Rebecca, Martha, Jane, Alexander, Robert Finley.

(IV) Rev. Jacob Kirkpatrick, son of Alexander (2) and Sarah (Carle) Kirkpatrick, was born August 8, 1785, died at Ringos, New Jersey, May 2, 1866. He was for many years a distinguished minister of the Presbyterian church. He married Mary Burroughs Howell, daughter of John Sutvan. They had children: John, Alexander, David Bishop, Henry Augustus, a physician; Calvin, Newton, Lydia, Sarah, Charles Whitehead, of whom further; Rev. Jacob, Francis J., Anna F., Elizabeth, Mary.

(V) Charles Whitehead Kirkpatrick, son of Rev. Jacob and Mary Burroughs Howell (Sutvan) Kirkpatrick, was born at Ringos, New Jersey, in 1827, died in Scranton, Pennsylvania, in December, 1912. In early life he engaged in harness making and carriage manufacturing, afterwards moving to Trenton, New Jersey, and there entered the dry goods business. In 1867 he came to Scranton and started in business as a manufacturer of spices and dealer in teas and coffees. For twenty years or more he continued this business under the firm name of C. W. Kirkpatrick & Company, in this city, and built up a strong and popular business. Retiring from this, he became agent for the Aetna Life Insurance Company, and continued in this until his death, when it was taken up by his sons, Jacob and Charles Lessey, as Kirkpatrick Brothers. Mr. Kirkpatrick was a strong Christian business man, and during his long and active career he held the universal regard of his fellows for the principles of high honor that guided his entire life. He was a devoted member of the Presbyterian denomination, and upon the organization of the Second Presbyterian Church in 1874, he was elected a ruling elder, an office he held until his death, a period of thirty-eight years. Mr. Kirkpatrick married Martha Bishop, a daughter of Bishop Skillman, of Pennington, New Jersey, and they had children: 1. Augusta, married George B. Foster, and is the mother of Charles K., Fannie and Marie. 2. Jacob S., associated in business with his brother, Charles Lessey; married Mary S. Lewers, and has children: Dixon and Margaret. 3. Clara, married R. B. Cissel, of Elizabeth, New Jersey. 4. Charles Lessey, of whom further. 5. Henry S., an employe of the County Savings Bank; married Margaret Hanley, and they had one son, Donald. 6. Willis B., a resident of Baltimore, Maryland; married Elizabeth Torrey, and has children: Catherine, Elizabeth, James B.

(VI) Charles Lessey Kirkpatrick, son of Charles Whitehead and Martha Bishop (Skillman) Kirkpatrick, was born at Trenton, New Jersey, November 4, 1863. After twenty years in various occupations, Mr. Kirkpatrick, with his brother Jacob S., succeeded his father in the spice, tea and coffee business in this city. The high reputation of the father is capably continued by the sons, the same policy of strict integrity bringing prosperity to the latter that gave the former prominence and success. Mr. Kirkpatrick married

Myrtle E., daughter of I. H. Burns, of Scranton. They have children: Evetyln F. and Eleanor S.

---

### JOHN J. TOOHEY

A descendant from an Irish family, John J. Toohey is numbered among the more recent arrivals in Scranton. In the comparatively short time that he has made that city his residence, he has, however, established himself firmly in the legal profession, and has identified himself with all the progressive movements, social and political, that have been inaugurated since his adoption of Scranton.

Thomas Toohey, father of John J. Toohey, was born in county Clare, Ireland, and when but a child was brought to the United States in the family of an uncle, his own parents electing to remain in the homeland, but realizing, with complete unselfishness of mother and father love, the advantages that would be open to their son in the United States, and heroically suffering themselves to be separated from their boy. His uncle located at Salem, Washington county, New York, and he there attended the public schools. For a time he was proprietor of a general store at Schuylerville, New York, where he became prominent in public affairs and held numerous public offices. He still lives in this town, retired from business, and spending his later years in quiet rest, after an active, well-lived life. He married Mary Mulvihill.

John J. Toohey was born in Schuylerville, Saratoga county, New York, June 23, 1874. His education was obtained in the public schools of his native place and later at Fordham University. Desiring and deciding to ally himself with the legal fraternity, he entered the office of the Schuylerville firm of Ostrander & Salisbury as student at law, completing his legal studies in Scranton, his preceptors in that city being Patterson and Wilcox. Passing a satisfactory examination he was admitted to practice at the Lackawanna county bar, March 17, 1901, engaging in general practice for three years, during which time he gained much valuable experience in the practical side of his profession, which, coupled with a deep and extensive knowledge of its finer points, makes him an attorney of no mean ability and one who in a legal battle may be considered a worthy adversary for the best of his contemporaries. In 1904 he received the election as county solicitor for a term of three years, and at the expiration of this was elected his own successor for a term of like length. He now is the incumbent of no public office and devotes his entire time and attention to his general practice, which is of large proportions and includes some of the city's proudest families. A forceful and convincing speaker, Mr. Toohey is a strong advocate. His defences and attacks are masterpieces of the orator's art, logically planned and masterfully executed. He is a worthy addition to Scranton's legal fraternity which includes as members many of the legal lights of the state, and not a few of the country's best. He is a member of the Benevolent and Protective Order of Elks, the Knights of Columbus and the Ancient Order of Hibernians.

Mr. Toohey married a daughter of the late Thomas Maloney, ex-mayor of Pittston, Pennsylvania. Children: Thomas M., Alice, Mary, Helen.

---

### T. ARCHER MORGAN

The course of the Morgan family is traced from the parish of Llangattoc, Carmarthenshire, Wales, to the parish of Llandefeilog in the same shire, where the pursuit of farming was followed on an estate which passed out of the family on the death of John Morgan, great-grandfather of T. Archer Morgan.



(I) John Morgan, born in 1777, lived his entire life on the farm of Pen-y-fedw where he died in 1857. He held various offices in the parish, married and among his children was David Thomas.

(II) David Thomas Morgan, born January 19, 1812, received an extended education in the town of Carmarthen where he fitted himself for the vocation of civil and mining engineering. His first work of any importance consisted of superintending a road-building project with headquarters at St. Clears. There he met and married Mary Saer, daughter of James Saer. His business as mining engineer subsequently took him to the counties of Pembroke and Monmouth where the greater part of his life was spent prior to coming to America. In September, 1869, he came, with his wife, to America and settled in Providence, Pennsylvania, where they had been preceded by their four children, Martha, William Saer, David Saer and Thomas Saer. The three sons had been trained by their father in mining engineering and thus the anthracite coal fields of Pennsylvania were the family's natural objective.

(III) Thomas Saer Morgan was born in Pembrokeshire, Wales, October 13, 1849. He had scarcely started his pursuit of mine surveying and engineering, under the direction of his father, when he came to America in January, 1869. He at once took a position at Providence with the Delaware & Hudson Canal Company, in the mining engineering department. His connection with this company, now the Delaware & Hudson Company, and in the same department has been continuous from 1869 to the present time, a term of service, the efficiency and faithfulness of which is proportionate to its extensive duration. He married, April 29, 1880, Emma, daughter of Alfred and Elinor (Jevons) Pitt, in Scranton. The Pitt family, though for many years residents of Scranton, are of English extraction. The children of this marriage are: 1. Eleanor Jevons, married William A. Edgar, of Ashley, Pennsylvania, parents of one son, Russell William. 2. Thomas Archer, of whom further.

(IV) T. Archer Morgan was born in Scranton, Pennsylvania, August 19, 1882. He received his early education in the public schools of this place and in the School of the Lackawanna and then entered Lehigh University whence he was graduated A. B., with the class of 1904. A course in the law school at Harvard followed, with the degree in 1907 of LL. B. After a period of study in Scranton under the preceptorship of Thomas F. Wells, Esq., he was admitted in February, 1908, to the bar of Lackawanna county. Commencing in 1909 he served as title officer with the Title Guaranty & Surety Company until July, 1913, when he became affiliated with the Scranton Trust Company in the capacity of trust officer. On October 15, 1910, he married Ruth, elder daughter of Dr. Frederick Charles and Georgia (Post) Johnson, of Wilkes-Barre, Pennsylvania. Ruth (Johnson) Morgan is a great-great-granddaughter of Rev. Jacob Johnson, missionary to the Indians, and first settled minister in Wilkes-Barre. He was a survivor of the battle of Wyoming, known in history as the "Wyoming Massacre" of July 3, 1778, and drew up the articles of capitulation. Mr. Morgan is an officer in the Thirteenth Regiment of the National Guard of Pennsylvania, a member of Peter Williamson Lodge, No. 323, F. and A. M., and of the Phi Beta Kappa fraternity.

---

#### WILLIAM H. CHANDLER

The emigrant ancestor of this line of the Chandler family, of which William H. Chandler is the representative in the business and mercantile world of Scranton, was George Chandler, who set sail from his English home at Greathodge, in Wiltshire, in the latter part of the seventeenth century. Historians of that period disagree as to whether George Chandler ever reached

the American shore, some claiming that he did and others asserting that he died of the smallpox on the high seas, and because of the deadly nature of his malady and the length of time that would elapse before land was reached, was given a sea burial. Be that as it may, his wife or widow, Jane, with several children, Jane, George, Swithin, William, Thomas, Charity and Ann, reached America, and founded one branch of that numerous family, which in 1882 celebrated at Brandywine Springs, Pennsylvania, the two hundredth anniversary of the landing of the American emigrant.

(I) William Chandler, the grandfather of William H. Chandler, was born at Wilmington, Delaware, January 14, 1787, died at the Chandler homestead, in New Garden township, Chester county, Pennsylvania, March 5, 1878. When but a child he was taken by his parents to Kentucky, where he spent his youth and grew to manhood. In the earlier years of his life he engaged in the manufacture of hats, retiring from active business life in his later years and devoting his time, care and attention to the management of the home estate, which he superintended with the same thorough methods that had characterized his business career. He married Ruth Anna Davis, born August 11, 1801, died March 22, 1846, daughter of Samuel and Sarah Davis. Children of William and Ruth Anna Chandler: Sarah D., born August 22, 1819; Mary M., November 18, 1820; Josephus, November 21, 1822; Edwin A., May 10, 1824; William P., October 22, 1825; John L., August 29, 1827; Anna, October 26, 1829; Esther L., July 4, 1831; Samuel D., September 26, 1835; Louis B., of whom further.

(II) Louis B. Chandler, son of William Chandler, was born at Kennett Square, Pennsylvania, in 1841, died in 1908. He was a regularly licensed druggist and conducted a pharmacy, at the same time being proprietor of a hardware store, both profitable businesses and well-patronized. He married Mary Elizabeth, daughter of William Hazzard, of Milton, Delaware. Her grandfather, David Hazzard, was at one time chief justice and governor of the state of Delaware. The two children of Louis B. and Mary Elizabeth (Hazzard) Chandler: Louis B., of New York, and William H., of whom further.

(III) William H. Chandler, son of Louis B. and Mary Elizabeth (Hazzard) Chandler, was born at Milton, Delaware, December 1, 1866. He attended the public schools of his birthplace and completed his studies at Swarthmore, Pennsylvania. For ten years after leaving school he was engaged in the fruit business in Delaware, a business that he still continues. He came to Scranton, Pennsylvania, where in 1897 he established in the wholesale fruit, grocery and general produce line, and in connection with the jobbing business he also conducts large orchard interests, located near Scranton at Lake Winola. Uniform success has marked his business career, resulting from the honorable and open methods he has pursued in all transactions. There is none of his business associates who does not have the most secure reliance in his integrity, and never once has this confidence been abused by a breach of probity. It is about principles of this nature that he has built up a business at once flourishing and lucrative and strong and vigorous in its growth. He affiliates with the Masonic Order and the Scranton Bicycle Club. His church is the Methodist Episcopal, while in political action he is entirely independent of party ties. Mr. Chandler married, in 1888, Sarah R., daughter of William Russel, of Milton, Delaware. They are the parents of two children, William and Sara, both of whom reside in Scranton, Pennsylvania.

## CHARLES CONNELL

A descendant of one of the old families of Cape Breton, Nova Scotia, Mr. Connell is of the second generation of this branch in Scranton. He is a grandson of James and a son of Alexander Connell, the latter born June 30, 1840, in Nova Scotia, at Cape Breton, coming to Pennsylvania when a young man. He was a man of high business quality and until his death, January 6, 1883, was an active member of William McConnell and Company, coal operators, and manager of the company's stores. He was a member of the Masonic fraternity and of the Methodist Episcopal church. He married Elizabeth Campbell of Scotch ancestry; children: Charles, of whom further; Victoria, married Dr. Charles B. Noecker, a practicing physician of Scranton, No. 213 Connell Building.

Charles Connell, only son of Alexander Connell, was born at Minooka, Pennsylvania, November 12, 1879. After a preparatory course in the public schools he entered the law department of the University of Pennsylvania, whence he was graduated class of 1902. He also read law under Ira H. Burns, of Scranton, and was admitted to the bar of Lackawanna county, December 15, 1902, and at once began practice in Scranton. He is a member of the Lackawanna County Bar Association, and in political faith is a Republican. His fraternal relations are with the Masonic Order.

Mr. Connell married, November 15, 1905, Teresa C., daughter of John Nallin. Children: Charles A., born August 24, 1911; Robert J., October 17, 1912. The family residence is at No. 738 Webster avenue, Scranton.

---

 J. NELSON DOUGLAS, M. D.

A graduate of Hahnemann Medical College of Philadelphia, J. Nelson Douglas, M. D., has been identified with his profession in the city of Scranton for nearly ten years, holding at the end of this time a position strong and assured, presenting a future view of further conquest and still more lofty station. The career of Dr. Douglas has been unusual in that prior to beginning the study of medicine he prepared himself thoroughly for an artisan's life by mastering the machinist's trade, going from the machine shop to the class room and from a position of experience and knowledge to a novitiate in medical science.

(I) His ancestry is Irish, the North of Ireland having been the birthplace of his father, Samuel Wark Douglas, and his grandfather, James Douglas, the former the founder of the line in the United States and a minister of the Presbyterian Reformed church. Children of James Douglas: James, a farmer of Ireland; Samuel Wark, see next paragraph; Emma, married William Quigg, and they had children, Nelson, Emily and Edna; Margaret, married (first) James Alcorn, and they had one daughter, Emma, (second) Robert Lowther, and was the mother of Robert, Maggie, Edwin, Bessie; Bessie, married (first) Dr. Kuhn, of New York, (second) Robert Wark, a native of Ireland; Mary, married Richard Steele, a native of the North of Ireland.

(II) Samuel Wark Douglas, son of James Douglas, was born in the North of Ireland in 1847. He was there educated and grew to manhood, remaining in that country until 1870 when he immigrated to the United States, and was for a time employed at the trade of carpenter, afterward becoming a student of theology at the Philadelphia Theological Seminary of the Reformed Presbyterian Church. He was graduated from this seminary and was ordained into the ministry of the Reformed Presbyterian church, later entering the educational work of the denomination, and being at the present time corresponding

secretary of the Worcester University of Ohio. He married (first) Susan McCandless; (second) Sarah Smith. By his first marriage he had: Emma, married William Quigg Jr., son of William Quigg, who married Emma, sister of Samuel Wark Douglas; Samuel, died in infancy; J. Nelson, see next paragraph. By his second marriage he was the father of Edward, William, Richard and Jean Smith. Edward graduated from the Western University of Pennsylvania, and is now practicing medicine at Connellsville, Pennsylvania. William is with the Davy Free Export as a foreman, or to be more explicit, the tree surgery business, that of properly trimming and sawing trees, which is located at Mountain Lake, Maryland. Richard graduated from the Worcester University of Ohio, and is now studying law at Western University Law School, Pittsburgh, Pennsylvania; he was for several years professor of English at the Worcester University. Jean Smith graduated with the degree of M. D. from the same University, and is now practicing at Worcester, Ohio.

(III) Dr. J. Nelson Douglas, son of Samuel Wark and Susan (McCandless) Douglas, was born in Philadelphia, Pennsylvania, January 3, 1875. He was educated in the public schools of Allegheny City, and in 1893 graduated from the West Middlesex High School. Soon after his graduation he began to learn the trade of machinist in the Pittsburgh Locomotive Car Works, of Allegheny City, and was there employed for four years. In 1901 he abandoned this occupation and entered Hahnemann Medical College, of Philadelphia, and four years later graduated M. D., the college also conferring upon him the special degree of Doctor of Homoeopathic Medicine. He then came to Scranton where he spent a year internship in the Hahnemann Hospital, the first to fill this position in the new Hahnemann Hospital. Dr. Douglas established in the practice of his profession, and from October, 1906, until June, 1908, he resided in Dunmore, at the latter date moving to Providence, where he continues in the profession to the present time. Dr. Douglas is a member of the Northeastern Homoeopathic Society, the Lackawanna Homoeopathic Society, and the Alumni Association of Northeastern Pennsylvania of the Hahnemann Medical College. He holds a position on the visiting staff of the Hahnemann Hospital of Scranton. His political party is the Republican. He is a member of the Independent Order of Odd Fellows, the Independent Order of America, and with his wife belongs to the First Presbyterian Church of Scranton.

Dr. Douglas married Gertrude Elizabeth, daughter of Rev. George E. Guild, D. D., who was for thirty-two years pastor of the Providence Presbyterian Church. Rev. George E. Guild, D. D., is the father of: George Clark, one of the managers of the Trust Fertilizer Company, of New York, married Mary Phelps, of Northampton, Massachusetts, and had one child, deceased; Burnham E., cashier of the First National Bank of Walton, Delaware county, New York, married Frances Hurlburt; Gertrude Elizabeth, of previous mention, married Dr. J. Nelson Douglas. Children of Dr. J. Nelson and Gertrude Elizabeth (Guild) Douglas: J. Nelson Jr., deceased; Malcolm Guild, born in February, 1911.

---

### JOHN LENTES

John Lentès was a fine example of that best type of German character which contributed so largely to the composite citizenship of the United States, and provided a leaven for the mass of those virtues peculiarly the possession of the great Germanic peoples, unswerving pursuit of the practical objective, painstaking industry, and a strong aesthetic sense, nowhere more clearly shown than in the wellnigh universal cultivation of the art of music. These characteristics not inaptly described Mr. Lentès' own personality, who was successful



*Thelmont Douglas M.D.*



alike in the realms of teaching, business and of the art of music to which he devoted himself. His father, Peter Lentes, was a native of Germany, where he spent his youth also the greater part of his active life, only coming to the United States in later life. He was a carpenter by trade while in Germany, following that occupation successfully. He married Christina Schuessler, who died before his removal to the "New World." His emigration took place in the year 1890, about nine years after his son, the pioneer of the family had reached these shores. Mr. and Mrs. Lentes Sr. were the parents of two children, John, of whom further, and a daughter, now deceased.

John Lentes, eldest child and only son of Peter and Christina (Schuessler) Lentes, was born August 7, 1856, in Germany, died November 15, 1913. He received the elementary portion of his education in the local volkschule, and from the start displayed a great aptitude for his studies, insomuch that at the age of fifteen years he became an assistant teacher in one of them. To this profession he concluded to devote his life, and to further himself in his determination he entered the Strasburg Academy, from which he graduated with distinction in the year 1877, at the age of twenty-one. He then became the recipient of a certificate from the government constituting him a government teacher, and returning to his chosen work he engaged in it for some time in his native land with a high degree of success. The time was one, however, when a great tide of migration was setting from Germany to the western republic, tales of whose democratic institutions, with opportunities open to all, fired the imaginations of the more enterprising in the "Old World." Mr. Lentes was one of those who heard the call and heeded it. In the month of March, 1881, he arrived in this country, and made his way at once to the state of Pennsylvania, where he settled in the city of Scranton. Turning at once to the profession with which he was already familiar, he opened a German school in the First German Presbyterian Church of Scranton, the location of which was on Hickory street. This school, under the skilled management of Mr. Lentes, made an excellent beginning, and would doubtless have become a well established institution had it not been for an occurrence which diverted his life from its intended course into another channel. It was a time when the industries of Pennsylvania were in a very rapid state of development, to the extent that an almost irresistible demand was made by them for the service of men of capacity. Ability of any kind within reaching distance was quickly recognized and absorbed by the growing leviathan, and it thus happened that its notice was quickly directed to Mr. Lentes. His services were sought by the Scranton Steel Company no later than September of the year of his arrival in this country, and an offer made him which he did not see his way to refuse. This was before the actual opening of their great mill, and in the meantime he was employed as a draughtsman. When the plant was finally in operation, Mr. Lentes became the first weighmaster of the concern, a position which he held for about two years and a half. He was then appointed by Mr. W. W. Scranton to be timekeeper for the railmill, carpentry and foundry departments of the South Works. After remaining at this work about two years longer, he was promoted to be assistant superintendent of the South Works, the position directly under Mr. John O. Scranton, then superintendent of that portion of the company's establishment. Desirable as such a position was in the great Scranton Steel Works, Mr. Lentes' heart was set upon an independent business, whereof he would be the master, and accordingly, after filling his responsible post for a number of years, he withdrew in 1895, and engaged in an insurance business of his own, becoming the representative of only the best and most firmly established companies, in

both the life and fire branches of the business. His enterprise was exceedingly successful and was prospering and developing at the time of his death.

Besides the insurance business, Mr. Lentz formed a number of other associations, financial, social and artistic, which brought him into constant touch with the life of the community in its various aspects. He was a stockholder in the South Side Bank, a member of the K. of P., Cornet Lodge, No. 431, of Scranton, of the Mutual Aid Society of the Delaware, Lackawanna & Western Shop, and of the Arbeiter Benevolent Association. He was a staunch member of the Democrat party, always took a keen interest in all questions of broad significance, and an active part in local politics and the conduct of the community's affairs. He was elected on his party's ticket as alderman of the eleventh ward of Scranton, and held that office a number of terms, to the great satisfaction of his fellow citizens. He was also a member of the sinking fund commission, and in 1897 was appointed a notary public by Governor Hastings, of Pennsylvania.

One of the most characteristic facts about Mr. Lentz was his great love of music, in the matter of which he was extremely active in Scranton, both in the case of secular music and in connection with the German Presbyterian Church, of which he was a member. He had been instrumental in encouraging the love of his art throughout his community, and had organized the "Junger Maennerchor" and the singing section of the Arbeiter Benevolent Association. He held for eight years the position of organist in the German Presbyterian Church and during that time officiated at the laying of the corner stone of the new church, the dedication of the structure, the dedication of the chimes and the dedication of the new organ, as well as on many other important and memorable occasions in the history of the church. The new organ, mentioned above, was very largely the result of Mr. Lentz's exertions, as it was chiefly due to him that the three thousand dollars necessary for its purchase was raised. He was also instrumental in organizing a chorus in connection with the church, which has devoted itself to the giving of concerts at which the works of the great choral composers are performed for the public. Mr. Lentz's association with the German Presbyterian Church was not confined to its musical activity, however. He was an earnest worker for its interests in all matters, and served for three years as superintendent of the Sunday school.

Mr. Lentz married, June 4, 1881, Magdalene Hampel, born in Germany. To them were born four children, three of whom are now living. They are as follows: Frederick C. W., a patternmaker by trade, leader of the orchestra in the Presbyterian church, and a member of the Symphony Society and of the Patriotic Order Sons of America; Magdalene and George W. All of Mr. Lentz's children inherit their father's musical gifts. Mr. Lentz was one of the most public-spirited of citizens and gave generously of his time and energy in the interest of the community of which he was a member. He was a conspicuous figure in the life of the town and none deserved more the universal respect and honor in which he was held.

---

#### CHESTER CRAIG SAMPSON

In connection with the multifarious affairs of the Scranton Life Insurance Company, the secretarial position is necessarily an important one, and more so that of superintendent of agencies, which is occupied at the present time by Chester Craig Sampson.

He was born in Peckville, Lackawanna county, Pennsylvania, November 20, 1888. He obtained his education in the Blakely High School. His



business experience has been obtained as agency director for the Northeastern Pennsylvania Railroad, covering nine counties; as secretary for six years for A. G. Thomson, manager of the Northeastern Pennsylvania Car Demurrage Bureau; in the real estate business for nearly two years in Scranton; and with the Scranton Life Insurance Company, of which he is assistant secretary and superintendent of agencies, having entire charge of the agency organization of the company. One of the youngest of Scranton's business men, the creditable manner in which he discharges the duties of his office, and the initiative and the self reliance he has displayed, mark him as one of a rising generation to whom the city and state must look for the perpetuation of its institutions, and the furtherance of its social and political ideals. He is a man of unusual business capacity and sterling personal qualities, and in the incredibly brief space of three years, by sheer force of industry and intelligent application of his talents, he has risen, step by step, from clerical work in the home office of the Scranton Life Insurance Company to a position, in point of importance, second to none in the gift of the company. Mr. Sampson's clubs are the Press and Temple, of Scranton; and he also holds membership in the fraternal orders, the Independent Order of Odd Fellows and the Free and Accepted Masons.

---

#### THOMAS AMBROSE DONAHOE

Thomas A. Donahoe was born in Scranton, Pennsylvania, January 31, 1878. His mother, Mary Donahoe, is living at the present time (1914) and he resides with her. He obtained his early and preparatory education in the public schools, being a graduate of the high school, class of 1894. His professional education was obtained at Dickinson College Law School, whence he was graduated LL. B., in 1902. He at once secured admission to the Lackawanna county bar and began practice in Scranton. He has a well established practice in all state and federal courts of the district, and stands high in the legal profession. In 1907 he was appointed second assistant district attorney of Lackawanna county by the able and upright incumbent of the office of district attorney, Joseph O'Brien. On January 1, 1912, he was advanced to first assistant, which position he filled until January 1, 1914. At the fall convention of the Democratic party of Lackawanna county, he was nominated for the office of district attorney.

For six years Mr. Donahoe was connected with journalism, being on the staff of the Scranton Truth. Also prior to his admission to the bar, he served in the capacity of court reporter and assistant city editor. He is a member of the Scranton Board of Trade and director of the South Side Bank. He is a member of St. John's Roman Catholic Church; Knights of Columbus; Scranton Lodge, of which he is dictator; Loyal Order of Moose; the Benevolent and Protective Order of Elks; the Junior Maennerchor; Scranton Country Club; and the Young Men's Institute, serving several terms on the board of directors.

---

#### CHARLES A. MASUCCI

Two generations of the Masucci family of Italy are now represented in the city of Scranton in the persons of Peter and Charles A. Masucci. Peter Masucci, the father, was born near Naples, Italy, in 1845, and was for many years a policeman in his native land. In 1908 he immigrated to the United States and resides in Scranton at the present time. He married Jennie De Matteo, and has children: Charles A., of whom further; Lawrence, a resi-

dent of New York, married Antonetta De Matteo and has one daughter, Clara; Antonetta, married Rocco Nicolo, of Scranton; John, a tailor of Scranton; Mary, married Paul Caruso, and has Frank, David, and Mary; Anthony J., unmarried, lives in New York; Rocco, unmarried, resides in Scranton.

Charles A. Masucci, son of Peter and Jennie (De Matteo) Masucci, was born near Naples, Italy, October 16, 1872. He obtained his education through attendance in the public schools of his native land, where he lived until 1896. In that year he came to the United States, landing in New York, and immediately proceeded to Scranton, where he was employed as a shoemaker until 1905. In that year he opened a shoe store at No. 201 South Main avenue, where he has since continued in profitable business. Mr. Masucci belongs to the Independent Order of Odd Fellows, the Victor Emmanuel Society, the St. Angelo Society, and the Progressive Club. His church is St. Lucia's Roman Catholic, and in politics he is an Independent. He is chairman of the United Italian Societies Hall Association.

Mr. Masucci married Josephine D'Ettoire, and has children: Jennie, born April 3, 1901; Albert, May 30, 1902; Marguerite, May 12, 1904; Emma, January 1, 1906; Edward, December 18, 1907; Flora, June 25, 1909; Louise, March 27, 1911.

---

### JAMES LAURENCE GAYNOR

As general manager of the Gaynor Contracting Company, Mr. Gaynor is the head of one of the most important firms of its kind in Scranton, and as its head has placed himself high in the estimation of his fellow workers, an able and competent business man. He is of Irish descent, son of Patrick J. and Mary (Hawley) Gaynor.

Patrick J. Gaynor was born in county Tipperary, Ireland, and Mrs. Gaynor was born at Silver Lake, Susquehanna county, Pennsylvania. At the age of fourteen years Mr. Gaynor came to the United States. About 1852 he entered the employ of the Delaware, Lackawanna & Western Railroad and later became purchasing agent of the ties and lumber for the Leggett's Gap Road. He piloted the first engine run on this road, the "Spitfire," on her trial trip, and was afterward employed for many years as passenger conductor on the Delaware, Lackawanna & Western, retiring from active service a few years before his death in 1890, aged fifty-five years. He was prominent in local political affairs, and active as well in those of national concern. During the Hayes-Tilden campaign he took the stump in behalf of the former. While a full blooded American in the truest sense of the word, he was prevented from taking up arms in defence of the Union cause during the Civil War by severe injuries received in a railroad wreck in the early part of 1861. His wife, Mary (Hawley) Gaynor, had twin brothers in the war, one of whom, Michael, was a captain in the Federal army, while the other, Thomas, held the same commission in the Confederate forces, he having located and married in the south several years before the war.

James Laurence Gaynor, third son and sixth child of Patrick J. and Mary (Hawley) Gaynor, was born in Scranton, Pennsylvania, April 21, 1872. He attended the public schools until he was fifteen years of age, and then entered the employ of the Bell Telephone Company, in whose service he progressed through the various grades until he was appointed assistant chief engineer. Desiring knowledge that would serve as equipment for a position of greater trust, responsibility and remuneration, he used a great deal of his spare time and his evenings in study, also arranging for and completing a special course in highway engineering at Columbia University. So well were his efforts



*J. L. Gaynor*



directed and so confident was he of his improved and increased ability that in 1907 he resigned from the employ of the Bell Company and entered the field of road contracting and city paving. His success in this line is eloquently expressed by the awarding to his firm of the contract for twenty-six miles of road, extending from the Luzerne county line to that of Susquehanna county, the largest road contract ever given in that section. The reputation of the Gaynor Contracting Company throughout the Lackawanna and Wyoming valleys is such that the name has become synonymous with reliability and fair dealing. Specification clauses of contracts are always scrupulously observed and the best of material used in all construction work.

Mr. Gaynor is a member of Benevolent and Protective Order of Elks, the American Society of Civil Engineers, the Engineers' Club of North-eastern Pennsylvania, the American Road Builders' Association, the Permanent International Association of Road Congresses of France, and the Scranton Board of Trade. He married Katherine Mitchell, daughter of James J. Mitchell, of Scranton; children: James Laurence Jr., Robert, Paul.

In direct proportion to the increasing importance of the Gaynor Contracting Company among the other firms of its kind has been the rise of Mr. Gaynor, the moving spirit and acting head of the concern, among his business associates. A fine business man, with a strong intellect and a comprehension easily grasping big propositions, he has an accurate prophetic vision and the dynamic force to carry out large projects. Filling a responsible position and daily confronted by stupendous problems in his chosen line of work, he has proven himself the master of them all, the right man in the right place, capably directing the company's projects. He is, moreover, the type of man with whom daily relations are a pleasure. Polite and courteous, he is not only a business man, but a business gentleman.

---

#### JOHN LOHMANN

Although not a native born Scrantonian, John Lohmann has spent the greater part of his life in this city, coming in 1865 and with the exception of one year and five months spent in Wilkes-Barre, has been a constant resident since that date. His father, George Lohmann, was born in the Kingdom of Bavaria, Germany, April 28, 1812; came to the United States in 1850 and fifteen years later to Scranton, where he died in March, 1907. He married Katherine Kleinlin, also a Bavarian, and had issue: George A., deceased; Philip, deceased; John, of further mention; Mary, deceased; Louis, deceased; Margaret, deceased; Philomenia, married George J. Schautz.

John Lohmann was born at Honesdale, Pennsylvania, August 25, 1854. He attended the German Lutheran School of Honesdale until he was eleven years of age, then in 1865 came to Scranton with his parents. He here became a slate picker at the Oxford breaker of the Delaware, Lackawanna & Western Railroad Company, working there until 1868, when he began working for Charles Tropp, the proprietor of the Lackawanna House. He continued in Mr. Tropp's employ until 1885, then spent seventeen months in Wilkes-Barre in the employ of his brother George A. He then returned to Scranton, and on May 1, 1886, became proprietor of a restaurant and cafe at No. 219 Lackawanna avenue, where he still continues in prosperous business. He is a member of the Hickory Street German Presbyterian Church, the Scranton Liederkrantz, treasurer of the German Building Association No. 10, an office he has filled since June, 1886. In politics he is an Independent.

Mr. Lohmann married, Mary A., daughter of Antone Klotz, of Clifton, Pennsylvania, and has children: Louise, married George C. Schuyer, clerk of

the United States district court in Scranton; Mabel, deceased; John A., and Robert G.

---

### MEREDITH JONES

In this record Wales is once more the country whence came the immigrant of the line, that land having been the home of the generations of the family prior to Thomas M., father of Meredith Jones, who came from there in 1850. Thomas M. Jones was born in 1825, and when twenty-five years of age came to the United States, settling at Tamaqua, Schuylkill county, Pennsylvania, where he was engaged in mining until his death in 1899. He became a loyal Republican, and was a charter member of the Scranton West Side Welsh Congregationalist Church. One of his brothers, Thomas, also immigrated to this country and enlisted in the Union army when war between the states was declared, serving in the army for the four years during which the war continued, in that time participating in all the engagements of his regiment without serious mishap. Thomas M. Jones married Gwennie Powell and had fourteen children, among whom were: John P., deceased; Benjamin L., connected with the postal service at Hyde Park, Scranton, Pennsylvania; Meredith, of whom further; Robert P., of whom further; Mary Jane, married Tullie S. Morgan, and resides in Ocean Grove, New Jersey; Elizabeth, deceased.

Meredith Jones, son of Thomas M. and Gwennie (Powell) Jones, was born at Tamaqua, Schuylkill county, Pennsylvania, April 9, 1858, and until he was seven years of age attended the public schools. At this youthful age he obtained employment in the mines of the locality as a slate picker, remaining in the mines in different capacities until he was twenty-seven years of age. He became a resident of the city of Scranton in 1862, and after forsaking mine employment established in milk and ice cream dealing which he continued for twelve years, after which he bought and sold second-hand furniture until 1913 with profitable success, in which latter year he retired, his two sons assuming the management of the business he had founded and nurtured to its present generous dimensions. In 1910, while so engaged, he built and opened the Park Theatre at No. 201 Main avenue, relinquishing the direction of its affairs in 1914, his son-in-law succeeding to his position. This venture also met with success, the theatre being a popular one and one of the favorite places of amusement in the city, with a seating capacity of seven hundred. Since his retirement Mr. Jones has found ample time to devote to study and reading, both of which possess a great attraction for him and both of which he has indulged to the utmost of his opportunities. This has been a desire and an instinct purely natural, for his tendencies in that direction had little opportunity for growth and expansion during his brief school days, so unfortunately curtailed by the necessities of life. He has the best of the world's literature stored in his capacious mind, and has the real student's love of the possession of favorite volumes, his library containing the works of classic and modern authors in which he finds the most enjoyment, irrespective of the judgment of critics and savants. Politics has been a field into which Mr. Jones has never ventured except as a loyal champion of temperance and an untiring toiler for the cause of temperance, the Prohibition party receiving the benefit of his influence as well as of his vote.

Mr. Jones married Letitia, daughter of Daniel Hughes. Her father, who died aged twenty-seven years, was an engineer in the Diamond Mines, and held membership in the Masonic Order. Children of Meredith and Letitia (Hughes) Jones: Frank, born in 1879, and Wesley, born in 1880, conduct the second-hand furniture business established by their father; Jessie, married

Horatio Vallance Jones, and has one daughter, Dorothy, born in 1912; Elizabeth, married Arthur Luce, and resides in Scranton.

---

### ROBERT P. JONES

Robert P. Jones, tenth of the fourteen children of Thomas M. (q v.) and Gwennie (Powell) Jones, was born on West Side, Scranton, Pennsylvania, May 17, 1866. As a youth he attended the public schools, and then became a slate picker in a nearby colliery, when a lad of seventeen years becoming associated with the Scranton Stove Works. His first position was in an unimportant capacity, but such eagerness to master the business and such tireless industry as he displayed could not be long denied their just reward, and he was raised through successive promotions to his present important post, superintendent of the foundry department. Length of service with any one concern is an unfailing sign of satisfactory and congenial relations between superiors and subordinates, and in the case of Mr. Jones it holds true in all force. His other business connections are as a stockholder in the Corno Silk Mills and in association with Sweeney Brothers, paving and sewer contractors, this last-named concern having just fulfilled a municipal contract at Forest City involving twenty-five thousand dollars.

Mr. Jones is a Republican politically, and for nine years was elected assessor of the sixth ward on the ticket of that party. He was the fusion candidate for the borough council, and was largely instrumental in securing the passing of the resolution for paving the sidewalks and installing sewers in the borough, two improvements that have added much to the beauty of the borough and to its desirability as a place of residence. Mr. Jones is a thirty-second degree Mason, and a member of Westminster Presbyterian Church, being president of its board of trustees.

Mr. Jones married Margaret, daughter of John H. and Rachel (Davis) Jones, and after their marriage they resided for a time in Hyde Park, Mrs. Jones' girlhood home, then moving to Dunmore, their present home being at No. 1369 Jefferson avenue. Children of Robert P. and Margaret (Jones) Jones: Thomas M., John H., Robert P. Jr.

---

### CHARLES E. TOBEY

The Tobey family is an ancient and reputable one in England. The earliest mention of the name in this country is found in the records of the Massachusetts Bay Colony, in the year 1634. The Tobey family of which Charles E. Tobey, of Scranton, Pennsylvania, is a representative, were resident in Otsego county, New York, but their first American settlement was in Connecticut, where they were early a prominent family. The paternal grandmother of Mr. Tobey was Celestia Grant, born May 24, 1809, a cousin of General Ulysses S. Grant, and her line of descent is as follows: Matthew Grant, born October 27, 1601, embarked from Plymouth, England, March 20, 1630, on the "Mary and John," and landed at Boston, Massachusetts, May 30, 1630; John, son of Matthew Grant, was born September 30, 1642; Josiah, son of John Grant, was born May 28, 1682; Ebenezer, son of Josiah Grant, was born March 2, 1723; Isaac, son of Ebenezer Grant, was born April 3, 1760; Isaac, son of Isaac Grant, was born February 3, 1785; Celestia, daughter of Isaac Grant, was married to Edward Tobey.

(II) Albert B. Tobey, son of Edward and Celestia (Grant) Tobey, was born in Otsego county, New York, September 22, 1831, was there educated, and learned the carpenter's trade. He was engaged in business as a con-

tractor and builder until his death at the age of seventy-five years. He married Helen Osborn, who preceded him in death many years.

(III) Charles E. Tobey, son of Albert B. and Helen (Osborn) Tobey, was born in Morris, Otsego county, New York, March 22, 1863. He attended the public schools of his native town until he was fifteen years of age, after which he attended school at Susquehanna, Pennsylvania, for two years. In February, 1880, he entered the employ of the Erie Railroad Company in the department of motive power, continuing until 1899, but in various departments, including ten years in the main office in New York City. On June 15, 1899, he located in Scranton, as chief clerk under Superintendent E. E. Loomis, head of the coal mining department of the Delaware, Lackawanna & Western Railroad Company. Two years later, Mr. Loomis having been promoted to the position of general manager, Mr. Tobey was advanced to the post of assistant superintendent. In 1911 further promotions were made, Mr. Phillips becoming general manager, Mr. Tobey advancing to superintendent, a responsible position he now holds with the same company with which he began as clerk in 1899. His rise has been a steady one and predicated in each stage on merit of so high an order that it could not be over-looked. He has been able to give most excellent reports of his stewardship during the years he has been superintendent of that department. He is a director of the Anthracite Trust Company, was one of the organizers of that company and is a member of the executive board.

Mr. Tobey is a man of varied tastes and disposition. Thoroughly a business man, he also is a lover of animals and poultry, and is so well known in this light that in 1912 he was chosen president of the Scranton Poultry and Pet Stock Association, and also president of the International Rose Comb Black Minorca Club. He is interested in Young Men's Christian Association work and is a director of the Railroad Branch. Fond of the fellowship of his friends and neighbors he has three times been chosen by them as president of the Green Ridge Club, and takes a solid enjoyment in the social life of the club. He served two years as president of the Scranton District Mining Institute; is a member of the Royal Arcanum, the Modern Woodmen of America, the Engineers' Society of Northeastern Pennsylvania and of the Scranton Board of Trade.

Mr. Tobey married, October 30, 1884, Annie E. Bartram, daughter of Charles T. Bartram, of Susquehanna, Pennsylvania. Children: Charles B., now connected with the Delaware, Lackawanna & Western Railroad Company; Hazel Dell, married Warren L. Fuller, of Scranton; Albert T., now with the Kresge Five and Ten Cent Store Company, at Harrisburg, Pennsylvania; Clarence L., attending Bellefonte Academy; Anna E., attending school at Scranton.

---

#### WILLIAM F. MCGEE

In the life of a city, such as Scranton, which sprang rapidly from a country hamlet into a thriving manufacturing center, there is no way to give a man place among his fellows except by his achievement, although in an older city, with long established institutions and firmly seated traditions, the importance of an individual may be predicted upon the deeds of his ancestors or the position held by his family. It is, therefore, the organizers, builders and promoters of Scranton who form the aristocracy of the municipality, and it is of one of this class, William F. McGee, with whom this narrative deals.

The ancestry of William F. McGee traces to Ireland, whence came his grandfather and settled in Carbondale in the early days of that place. Here





C. E. Tobey.



Patrick McGee, father of William F. McGee, was born and here spent all his life in the coal mines of the immediate vicinity. The unhealthfulness of his employment speedily undermined his strength and his life was cut off in its prime in 1897. He married Mary, daughter of Michael Devine, of English descent, and had seven children who attained maturity: William, Thomas, Patrick, Mary, Elizabeth, Frances, Jane. Mary (Devine) McGee died in 1910, aged sixty years.

William F. McGee, son of Patrick and Mary (Devine) McGee, was born in Scranton, Pennsylvania, February 22, 1872. He attended the public schools of his native city and here his entire school education was obtained. His first position was in the employ of Rice, Levy & Company, where he remained for five years, leaving to begin an association with the Maloney Oil Company, which continued pleasantly and profitably for eighteen years, during which time he acted as manager of the works. In 1903 he was the principal organizer of a company to promote slag roofing, a roof covering now much in use, and since that time has been treasurer of the company. The concern is the only one of its kind in Scranton and employs about forty persons. Contracts are made for roofing, which include the laying of the material, and a flourishing business is done by the company, the durability of this compound gaining many users. The Diamond Oil and Paint Company, as yet an infant industry, was organized in 1911 and at the present time covers territory within a radius of seventy-five miles of the Scranton headquarters. The officers, which are the same as at the time of incorporation, are: E. J. Lynett, president, John H. Foy, secretary, and William F. McGee, treasurer. Mr. McGee's thoroughness and scrupulousness in financial dealings make him an excellent choice for treasurer, his reports being clear, definite and comprehensive. He is actively interested in politics, although never accepting public office, and strongly sympathizes with the Democratic party. He is a member of the Knights of Columbus and has been a delegate to the National convention of the order, also belonging to the Catholic Club and to the Old Guard.

Mr. McGee married Mary E., daughter of Patrick Mitchell, of Scranton, and has four children, Thomas, William, Robert, Marion. Mr. McGee is the active type of business man, always on the alert for opportunity, not content to sit passively by and to wait for fortune, but ever seeking better and larger fields. He owes his present position entirely to his own efforts and as he is but a young man, his part in the future of his city, from the promise of his past record, should be one of prominence and honor.

---

### JOHN JENKINS OWENS

This branch of the Owens family was planted on American soil by John Jenkins Owens, who was born in Wales, July 29, 1834, and came to the United States in 1869. He located in Providence (Scranton) which was his home until his death in 1912. He was a miner by occupation and worked continuously at that business until his retirement in 1900. He married Louise, daughter of John Prosser, and had issue: David, Jenkins, Mary Ann, Lilly, Annette, Sarah, Jennie, John Jenkins, of whom further.

John Jenkins Owens Jr. was born in Scranton, Pennsylvania, November 23, 1876. He obtained all of the public school advantages of the city and pursued courses of study at Bucknell Academy, later entering Bucknell College. In 1906, being then thirty years of age, he completed a course of legal study at the University of Michigan, receiving his degree, LL. B., with the class of that year. After passing the Pennsylvania state board of examiners, in 1907 was appointed secretary of the civil service board in that city. During

the war with Spain in 1898 Mr. Owens enlisted in Company A, Thirteenth Regiment Pennsylvania Volunteers, and spent eleven months in the service, principally in the south, being mustered out in Georgia. He is a member of Colonel T. D. Lewis Council, Junior Order of United American Mechanics; Rescue Lodge, Knights of Pythias; Lincoln Lodge, Independent Order of Odd Fellows, and Green Ridge Camp, Modern Woodmen of America. In politics he is a Republican, and in religious faith a Methodist.

Mr. Owens married Lou, daughter of John Wesley Young, of Rochester, Michigan, her mother, who was a Miss Brewster, a lineal descendant of the Pilgrim, Elder William Brewster, of the pioneer Plymouth colony, of which he was a leading spirit. Children: J. Alton, born April 3, 1908; Jack, born February 11, 1911; Brewster, born March 27, 1913.

---

### JOHN R. JONES

Welsh in descent and birth, John R. Jones is American in every other respect, having been brought by his parents to the United States in his infancy. He is well and favorably known as a druggist of Providence, Pennsylvania, a calling he has followed throughout his entire life, his father, William R. Jones, having been connected with mining in his new home.

John R. Jones is a grandson of John Jones, a native and life-long resident of Wales, where were born two sons, William R., of whom further, and John. William R., son of John Jones, was born in Wales in 1839, died in 1894. After his immigration to the United States in 1869 he engaged in mining until his death. He married Esther Edwards, a native of Wales, and had children: 1. Mary, married Daniel Bevan, of Miners Mills, Pennsylvania. 2. William D., an engineer of Wilkes-Barre, Pennsylvania; married Emily Littlefield, and has one son, Gomar C. 3. Hannah, married Thomas H. Price, of Wilkes-Barre, formerly a mine inspector and at the present time general manager of a mine at that place; children: William, Thomas, Richard, Earl. 4. John R., of whom further. 5. Sarah, deceased. 6. Gomar C., manager of the Knoepf-fell Drug Store at No. 650 Adams avenue; married Pearl Loveland, and has one daughter, Esther. 7. Elvira, deceased.

John R. Jones, son of William R. and Esther (Edwards) Jones, was born in Wales, December 11, 1868, and the following year was brought to the United States by his parents. He attended the public schools and graduated from the high school at Plains, Pennsylvania. When he was fifteen years of age he became employed in the drug store owned by Charles Maher, at Miners Mills, Pennsylvania, and afterward established in the same line independently in that place. Moving to Jermyn, Pennsylvania, in 1892, he was for three years employed with Dr. Davis, proprietor of a drug store in that place, Mr. Jones in 1895 severing his relations with Dr. Davis and opening a drug store under his own name. Upon the destruction of this store by fire in 1904, Mr. Jones established in business at No. 2431 North Main avenue, his present location. His well appointed pharmacy and the excellent service there received gives his establishment the popularity it deserves. In line with his professional interests, Mr. Jones is a member of the Lackawanna County Druggists' Association and the Pennsylvania Pharmaceutical Society. He affiliates with the Improved Order of Heptasophs, and belongs to Celestial Lodge and Electric City Encampment, Independent Order of Odd Fellows. His political party is the Progressive.

Mr. Jones married Jeannette, daughter of Thomas Reese, of Miners Mills, Pennsylvania, and has one son, Willard, born in 1891, a graduate of the Scranton High School.

## HARRY J. JONES

Founder and proprietor of the Woodlawn Farm Dairy, Harry J. Jones has added to the business interests of Scranton a line that has well demonstrated its worth and strength and is at the present time known and listed as one of the substantial and flourishing businesses of the city. A native of Wales and there educated, Mr. Jones is a descendant of Welsh ancestors, that country having been the birthplace of his grandfather, Daniel Jones, who there died in 1884. He was the father of: John, of whom further; Daniel and Isaac, residing in Wales; Morris, met his death in a mine accident; David, came to the United States in 1913, now lives in Edwardsville, Pennsylvania; Jennie, married a Mr. Griffiths, of Edwardsville; Jane, deceased.

(II) John Jones, son of Daniel Jones, was born in Wales, in 1854, and came to the United States in 1892, settling at Elk Mountain, Pennsylvania, and there engaging in farming. He married Frances Vallance, and has children: Harry J., of whom further; George W., employed by the Pittsburgh Steel Company, married May Carpenter, and has one son, Chester W.; Horatio Vallance, married Jessie Jones, and is the father of one child, Dorothy; Jane Frances, married Howard Wells, of Elkdale, and has a daughter, Elna; Frank F., married Blanche Churchill, has one daughter, Frances, and lives at Elk Mountain, Pennsylvania.

(III) Harry J. Jones, son of John and Frances (Vallance) Jones, was born at Cardiff, Wales, April 23, 1878. He attended the grammar and high schools of his native land for nine years, at the end of that time becoming a salesman in the employ of his father, at that time engaged in business in the homeland. This he soon abandoned to come to the United States, which he did in 1892, arriving in Scranton on the Saturday following Thanksgiving Day in that year, his first position in that city being with the Ansley Lumber Company, where he remained for eighteen months. His father having rented the farm of Isaac Hair in Rush township, Mr. Jones for two years assisted him in its cultivation, the elder Jones at the end of that time moving to the property of T. J. Davis, of Elk Mountain, which they rented for two years before purchasing. Here Mr. Jones resided, engaged in agricultural operations, until the beginning of the war with Spain, when he enlisted in Company M, Eleventh Regiment United States Infantry. This company was forwarded to Fort McPherson and then to Tampa, Florida, where under General Miles it embarked for Porto Rico, and after the regiment landed at Ponce then proceeded to Yaucoco where they mobilized and then marched to Sabe Grande, and on to San Germane, then to Homequiras, where they were engaged with the enemy for three hours on August 13. The following day the regiment, which was almost full strength, numbering twelve hundred men, proceeded to Mayaguez, and after here performing patrol duty for a time once more set out on the march. Hostilities having ceased pending arbitration, the regiment returned to Mayaguez, and here Mr. Jones' company remained until October 15, the greater part of the members thereof being upon the sick list. Receiving orders to proceed the company went to San Juan, arriving in that place on October 21, the day on which the Spaniards evacuated the city. The company being disbanded and its members discharged from the service, Mr. Jones returned to Scranton, having during his enlistment been raised to the rank of corporal. In 1900, after his marriage, he made his home on the T. J. Davis farm in New Milford township, one year later moving to Scranton and for three years holding the position of yard foreman with the Ansley Lumber Company, a relation filled with satisfaction to employers and employee.

He left this concern to establish a business of his own, the result of a plan that had been forming in his mind for some time, and opened the Woodlawn Farm Dairy at No. 315 North Main avenue. This dairy plant is equipped thoroughly with the most modern appliances and machinery for the pasteurizing, bottling and capping of milk and for the manufacture of butter. One of the most pleasing features of the plant is the complete sanitary arrangement, all possibilities and opportunities for the pollution of the products in the slightest degree being lowered to a practically irreducible minimum. Mr. Jones' dairy is a striking illustration of the changing usages and customs of the times, for it has been but a few years since when the idea of such an establishment would have been roundly scoffed. At this place he conducts a business whose growth has exceeded even the most sanguine hopes of its founder, his establishment having sprung into instant favor which has steadily increased with the passing of the years. Mr. Jones also has creameries and receiving stations at Herrick Center and Lake Winola. Mr. Jones is a Republican in politics. He worships with the Welsh Baptist Church, and is a member of Hyde Park Lodge, Free and Accepted Masons, and the Knights of Pythias.

Mr. Jones married, April 18, 1900, Jessie, daughter of William and Mary (Williams) Wicks, of Scranton. Mr. Wicks is a native of England, his wife born in Wales, the former coming to the United States in young manhood, the latter when she was twenty-one years of age. Their children: Hattie, married John H. Phillips; Agnes, married T. D. Morgan, of Scranton; Albert, married Mary Sullivan; Jessie, of previous mention, married Harry J. Jones; Thomas, married Mary Schultz. Mr. and Mrs. Jones are the parents of one daughter, Agnes, born May 24, 1901.

---

#### HARRY T. MADDEN

Harry T. Madden, proprietor of the Nash and Holland Hotels, one of the most popular hosts of Scranton, is well known, not only in business circles, but in social and musical coteries as well. He is a son of Thomas C. Madden, born in 1839, a farmer of Wayne county, Pennsylvania, which district he served for two terms as commissioner. For thirty years he held the office of justice of the peace and for more than that length of time was one of the representative and prominent men of his locality, being among the leaders in all projects for the public benefit, ever ready and willing to bear his share of the labor and responsibility entailed. That patriotism was not the least of his passions was shown by his early enlistment in the Union army, after the president's call for volunteers, and for three years and nine months, until the conclusion of hostilities, he was at the front with his regiment. He married Mary E. Wolf, and had: Bert; William, a resident of Scranton; Anna, married William Salattie; Harry T., of whom further; Frank.

Harry T. Madden, son of Thomas O. and Mary E. (Wolf) Madden, was born in Wayne county, Pennsylvania, January 27, 1878. In his youth he attended the public schools, completing his education in the Scranton-Laekawanna Business College. His first employment in Scranton was with the Quackenbush company, wholesalers, with whom he remained about six months, and in 1903 he received a call from Rev. Rogers Israel, of St. Luke's Episcopal Church, asking him to take charge of the work at the Scranton Boys' Industrial Association, a position he held until 1907, and according to the boys who knew Mr. Madden when he was in charge, there was not a more popular man in the association. Athletics thrived during his administration, he always had championship baseball, football, basketball, running and wrest-

ling teams. He was the advocate of clean sport, and while he was in charge the boys all knew that everything had to be on the square. Later he became proprietor of the Nash Hotel, which he conducted until 1911, in which year he added to his possessions the Holland Hotel, at the present time operating both houses of entertainment. In addition to his hotel business, Mr. Madden maintains a modern catering establishment, with accommodations capable of providing for large numbers, and in this line he holds a reputation that equals his renown as a host.

Mr. Madden is a lover of music and has been endowed with talent of an exceptional order, holding membership and taking an active part in the leading musical organizations of the city. For a number of years he has belonged to the Junger Mannerchor and Elm Park Choral Society, and for nine years has been a member of the Anthracite Male Quartette. He takes part in all the important musical entertainments and fetes in the city, and whenever Scranton is represented in like events in other sections of the country. He is a member of the body delegated by the city to uphold its musical honor in competition with the other cities of the world, having been a member of the chorus that was awarded the first prize at the Louisiana Purchase Exposition at St. Louis, and he went to Pittsburgh with the choir under John T. Watkins. He has recently been selected as chorister of the Anderson evangelistic party, being thoroughly qualified for the position, owing to the fact that nearly all his life he has been a gospel singer, excelling in chorus leading. During the recent revival campaign in Scranton, Mr. Madden had charge of the overflow meetings in Elm Park Church, and his pleasing personality and the excellent manner in which he handled the crowds left a deep impression. Not only in Elm Park Church did Mr. Madden lead singing, but every Sunday afternoon he would have charge of the singing at the Young Men's Christian Association, where nearly one thousand men gathered to worship and hear good speakers. For five years Mr. Madden was in charge of that part of the program for the association, and therefore is fully equal to take charge of the music at Coatesville with Dr. Anderson. Mr. Madden has a wonderfully rich voice, and can make himself heard no matter how many are singing.

Raised by strong Christian parents, Mr. Madden himself has been a true Christian the greater part of his life, holding membership in the Methodist Episcopal church, to the affairs of which he has devoted much of his time, especially to the musical part, and for three years he has led the singing in the primary department of the Elm Park Sunday school. Mr. Madden's fraternal connections are with the Independent Order of Odd Fellows, the Knights of Malta, the Patriotic Order Sons of America, and the Masonic Order, in which he holds the Knights Templar degree and belongs to the Nobles of the Mystic Shrine.

Mr. Madden married, June 14, 1910, Grace, daughter of Walter W. and Susie E. Brown. She is a graduate of the Scranton Conservatory of Music. She has always been a great help and inspiration to Mr. Madden in his work. Children: Ralph Clarke, born December 25, 1911, and Ruth Lucelia, born July 8, 1913.

---

#### SEYMOUR EDMUND JONES

Three generations of the Jones family of Wales have been connected with Scranton in business dealings, two as merchant tailors, the present as a pharmacist. William Jones, grandfather of Seymour Edmund Jones, was a native of Wales, and was at one time a member of that select body, the pride and envy of the English army, the Queen's Guards, composed of the most finely

formed soldiers in the service. After coming to the United States he settled on the West Side of Scranton, and there conducted a tailoring business. He married and had children: Randolph, of whom further; William, a merchant of Hyde Park; Matilda, married George T. Morgan, and resides at Nanticoke, the mother of Matilda and Jennie.

(II) Randolph Jones, son of William Jones, was born in Cardiff, Wales, in 1842, and when seven years of age was brought by his parents to the United States, attending the public schools of this city. When he had attained sufficient years he became his father's assistant, later being proprietor of a tailoring establishment, continuing in this line of business for a period of forty years, during which time he gained a wide reputation as a careful and skillful workman, the demands of his many customers keeping him constantly busy. His death occurred in October, 1904. He married Lulu, daughter of Frederick Nichols, a hardware merchant of Scranton, and had children: Frederick R., born in July, 1879, resides in New York City; Seymour Edmund, of whom further.

(III) Seymour Edmund Jones, son of Randolph and Lulu (Nichols) Jones, was born in Scranton, Pennsylvania, January 15, 1881. He attended the public schools of his native city, his course including high school instruction. In young manhood he was for four years employed in the pharmacy of W. H. McGarrah, of Scranton, there obtaining practical and useful knowledge of the profession he later took up in the Buffalo College of Pharmacy. In his sophomore year in this institution he satisfactorily passed the state board examinations, and after his graduation was for six years employed as prescription clerk in the Sanderson Pharmacy in Scranton, later purchasing the business from Norman Stuart, H. C. Sanderson's successor. Mr. Jones has since continued the business with marked success, his pharmacy possessing all the departments characteristic of the modern drug store, an institution differing so widely from that from which it sprang. Up-to-date equipment and reliable service constitute the keynote of the pharmacy's popularity, Mr. Jones exacting most scrupulous care from all connected with his business. He holds membership in Peter Williamson Lodge, No. 323, F. and A. M., and the Scranton Board of Trade. His church is the Immanuel Baptist, and politically he is a Republican.

Mr. Jones married Bessie L., daughter of William G. Daniels, her father a native of Wales, who came to Scranton as a young man, for several years being a clerk of courts and recorder of deeds in the city. Mr. and Mrs. Jones are the parents of one son, Randolph W., born December 11, 1906.

---

### JOHN MASUCCI

After a youth and early manhood spent under the blue skies of Italy, John Masucci, with his youth, vigor, tailoring skill and artistic temperament came to the United States where he has gained an honorable position as one of the leading designers of women's fine tailored costumes. He is the son of Pietro Masucci, a soldier of the army of Italy, twice honored by medals for bravery, a blacksmith by trade, a general merchant, and for twenty-five years an officer in the police service of Italy. In 1907 he disposed of all his possessions and came to the United States, locating in Scranton where he now resides. He married, in Italy, Jane Dematteo, daughter of a merchant of Guardia; children: Angelo, Lorenzo, Antonia, John, of whom further; Maria, Rocco. All of these came to the United States except Antonia, and all reside in Scranton except Maria.

John Masucci was born in Guardia, Lombardy, province of Avellino,



Italy, December 10, 1881. He was well educated in the public schools, and after two years at a leading gymnasium (college) began learning tailoring and designing. He became an expert worker in cloth and as a designer of women's costumes, continued until 1898 when he engaged on the German steamship "Kaiser Wilhelm Der Grosse" and came to the United States, locating in New York City. There, for two years, he was employed by some of the best women's tailoring firms of the city, and during the same period attended high schools, acquiring a knowledge of the English language and increasing his store of general learning. In 1904 he came to Scranton where in partnership with his brother Lorenzo, and Gaetano, he opened a tailoring shop at No. 107 Wyoming avenue, but only continued one year. In 1910, having worked for others during the intervening period and obtained a complete understanding of the requirements and conditions, Mr. Masucci opened a high class ladies' tailoring shop at No. 401 Traders' National Bank Building. Here his artistic designs and finished workmanship have attracted a liberal patronage, his customers numbering many of the leading families of the city. His success in Scranton encouraged him to broaden his field of operations, and in September, 1913, he opened a similar shop in Wilkes-Barre, Pennsylvania. He is highly regarded among his countrymen and by all who know him, is a naturalized citizen and progressive Republican in his political affiliation. He is a member of Hyde Park Lodge, No. 339, F. and A. M., Christopher Columbus Lodge, No. 1160, I. O. O. F., and of several distinctive Italian societies and orders. He married, in 1904, Antonetta, daughter of Nunzio Razzano. Children: Helen, Laura, Peter, John (2), Astera.

---

#### WINFIELD SCOTT HAINES

After an interesting career, confined largely to railroad work and touching many departments thereof, Winfield Scott Haines, descendant of Scotch and English ancestry of New England residence, remains in that calling as master mechanic in the Dunmore shops of the Wyoming Division of the Erie Railroad, with which road he has been connected for a period of twelve years in Pennsylvania and New Jersey. Mechanic, fireman and engineer are three of the grades of service he has filled as a railroad employe, and there is little in that line with which he has not become thoroughly familiar during his long career.

Philips, Maine, was the home of Reuben Haines, of English descent, that having been his chosen residence upon coming to Maine, and there he passed the greater part of his life. His wife, a Miss Ridley, was a member of a Scotch family, and among their children was Alonzo, a native of Maine, who early in life acquainted himself with the trade of millwright. His residence was unsettled, his home having been at various times in La Crosse, Wisconsin, Onalaska, Wisconsin, and Janesville, in the same state. He was for three years a farmer near Palatine, Illinois, afterward moving to Oshkosh, Wisconsin, returning to work at his trade, millwrighting. He afterward, in partnership with a brother, established in business as bridge builders and contractors, their business becoming one of the largest of its kind in the country, their operations as bridge builders extending over a wide area. In 1863 he went to Nashville, Tennessee, to execute a contract with the United States government, and there, in March of the following year, his death occurred, when he was forty-three years of age. He married, in Rockland, Maine, Lavina Brown, who died at Enderlin, North Dakota, in 1894, aged seventy-four years, her father a sea captain. Both were members of the

Methodist Episcopal church, and were the parents of four children, of whom Winfield Scott is the only survivor.

Winfield Scott Haines, second child of Alonzo and Lavina (Brown) Haines, was born in Strong, Maine, May 19, 1850, and when three years of age was taken by his parents to Janesville, Wisconsin, thereafter accompanying them in their numerous changes of residence, attending school in each place. After the death of his father Mr. Haines began the work of life, his first position being as a fireman in a match factory owned by J. C. Clark, of Oshkosh, Wisconsin, after which he was employed in the machine shop operated by Morris & Page. In 1868 he became a fireman on the Chicago & Northwestern Railroad, in the following year moving to Lowell, Massachusetts, and entering the Lowell Machine Shops under John E. Downs, contracting foreman. Four years later he left the Lowell shops and became a fireman on the Boston, Lowell & Nashua Railroad, afterward becoming engineer on a switch engine in the Lowell yards of the road. The Wamesitt Steam Mill Company, of Lowell, Massachusetts, next commanded his services in the position of engineer, and in 1878 he moved west as the employee of the Northern Pacific Railroad, his duties those of machinist, while at times he served as engineer. In February, 1880, he resigned from this employ and for one year was a machinist in the shops of the Chicago, Milwaukee & St. Paul Railroad, at Sanborn, Iowa, subsequently becoming an engineer on the same road. Until 1886 he filled the position of general foreman in the Sanborn works, and in June of that year engaged in construction work on the projected Minneapolis & Pacific Railroad, at the direction of F. D. Underwood, division superintendent. In August, 1886, he became master mechanic in the same employ, remaining thus until the completion of the road, after which work was begun on the road now known as the Minneapolis, St. Paul & Sault Ste. Marie.

Mr. Haines felt, in 1888, the restless desire that often comes to those who have once held the throttle of a locomotive, and he returned to his old calling, that of engineer, for four years having a passenger run between Gladstone and Sault Ste. Marie, at the end of that time once more assuming the duties of master mechanic. The Baltimore & Ohio Railroad became his master in November, 1898, his rank the same as formerly, and until 1902 he was located at Newark, Ohio. In the latter year he entered the service of the Erie Railroad at Jersey City, New Jersey, and in March, 1904, was transferred to the Wyoming Division of that road, and has since been a master mechanic in the shops of Dunmore.

Although not appearing in its proper place in the above narrative, Mr. Haines has been, as well as a stationary and railroad engineer, a marine engineer, bringing the "Evangeline" from tidewater to Lowell, Massachusetts, she being the first and only steamboat to make that voyage. He also ran an excursion boat from Lowell to Nashua, New Hampshire, the excursion line having been a part of a carefully planned piece of political strategy on the part of the well known politician, "Ben" Butler, who was then working on a waterways appropriation from Congress.

Mr. Haines is as thoroughly proficient in his calling as knowledge and mature experience can make one. His record contains naught but satisfactory service, and in the positions of responsibility he has held, whether at the locomotive throttle, in construction work, or in the shops, he has risen to emergencies with prompt initiative that marks the man of resourcefulness, courage and confidence. Mr. Haines is a member of the Dunmore Methodist Episcopal Church, the Masonic Order, and the Scranton Engineers' Club.

Mr. Haines married Fannie Presho, born in Running Water, South Dakota,



Winfield S. Hansen



daughter of Nathaniel Presho, her father a cattle raiser of South Dakota, his ranch located about four miles from Running Water. Children of Winfield Scott and Fannie (Presho) Haines: Genevieve, married James McKesson, district manager of the firm of Corrigan & McKinney, proprietors of an iron foundry in Pittsburgh; Jane.

---

#### HOWLEY BROTHERS

The brothers, Peter F. and Michael T. Howley, are sons of Michael and Mary (Brown) Howley, both parents born in county Mayo, Ireland. Michael Howley came to the United States about 1854 with his wife and two children, proceeding to Scranton immediately after his arrival in New York. He secured employment at once, first aiding in the construction of the Delaware, Lackawanna & Western Railroad, later in the coal mines. He died in 1871. He was a member of the Ancient Order of Hibernians, the Loyal Sons of Saint Patrick, and a communicant of the Roman Catholic church. Children who grew to years of maturity: John, Anthony, Peter F., of whom further; Ellen, married James J. Duffy, of Scranton; Michael T., of whom further.

Peter F. Howley was born in Scranton, June 17, 1863. He attended public school in his boyhood, but at an early age began business life, beginning as a cash boy in the old Boston Store. He advanced rapidly and ten years later, when he left that employ, was cashier and confidential clerk to the proprietor, R. M. Lindsay. On leaving Mr. Lindsay in 1894, he became a partner of the hardware and plumbing firm of Howley Brothers, consisting of John, Peter T. and Michael T. The firm continued until August, 1894, when the two younger brothers formed the firm of P. F. and Michael T. Howley. The firm started in a small way, employing but one man besides the partners. They have prospered and expanded, the firm now consisting of the two younger brothers and employing from twenty to thirty men, principally on contracts in Scranton and the Lackawanna Valley. Their line covers all kinds of plumbing, heating, tinning, sheet metal and ventilating work. Their place of business is at No. 233 Wyoming avenue. Peter F. conducts the office business, Michael T. being the outside member of the firm. Peter F. Howley is a member of the Knights of Columbus, the Catholic Club and of several of the societies of the Catholic church. He married Mary Duffy, who died in 1903.

Michael T. Howley was born in Scranton, Pennsylvania, December 18, 1867. He was educated in public schools in Scranton, learned the plumber's trade and as noted above entered the firm with which he has continued until the present time. He is a member of the Catholic church, the Knights of Columbus, Catholic Club, and Benevolent and Protective Order of Elks. He married Mary Duff, who died in 1906, three sons, Peter F., Thomas J. and Maurice.

---

#### BARTLEY FULLER

Bartley Fuller is a member of a family planted in Pennsylvania from New Jersey by Peter Fuller, grandfather of Bartley Fuller, a native of the latter state, who made his home in South Cauaan, Wayne county, Pennsylvania. He married Mahala Myers and had children: 1. Hiram, a farmer of Pennsylvania, married and had six children: Jacob, Maria, Amanda, Zielphia, Thomas, Chancy. 2. Dennis, married and had two children, John P., Sarah Jane. 3. Collins, of whom further. 4. Susan, married Samuel Spangenberg. 5. Pierson, married Susan Stevens, and had three children: Joseph, Annie, Frederick.

(II) Collins Fuller, son of Peter and Mahala (Myers) Fuller, was born in New Jersey, November 24, 1830, died in Scranton, Pennsylvania, February 16, 1913. When he was twenty years of age his father took his family to South Canaan, Wayne county, Pennsylvania, where Collins Fuller learned the trade of carpenter, afterward assisting his father on the home farm. He was for a time a resident of Lackawanna county, at that time Luzerne county, soon returning to South Canaan, and living there until 1887 when he moved to Scranton and there remained until his death. He married (first) Louise Schumard, (second) Nancy Spangenberg. Children of first marriage: 1. and 2. George and John, both deceased. Children of second marriage: 3. Bartley, of whom further. 4. Emma, married E. E. Berry, of Scranton, and has children, Marguerite, Maud, deceased, Mabel, Meredith, Emma, George, Elmer. 5. Susan, married A. H. Kresge, and is the mother of Ralph, Pearl, Luther. 6. Ella, died aged eighteen years. 7. George, married a widow, Catherine (Hobbs) Sloss, and is the father of Anthony, Elmer, Winfield.

(III) Bartley Fuller, son of Collins and Nancy (Spangenberg) Fuller, was born at Salem, Wayne county, Pennsylvania, September 9, 1864. Until he was twenty years of age he attended the public schools of South Canaan. For two years after leaving school he was employed on a farm, and on April 1, 1887, he moved to Scranton, and for twenty-two years was engaged in the Delaware, Lackawanna & Western Railroad car shops. At the end of that long term of service he became engineer in the power plant of the Northern Electric Company at Dalton, Pennsylvania, remaining in that capacity for four years. His present position is that of caretaker of Scranton Public School No. 42. Mr. Fuller is a member of Dunmore Lodge, Independent Order of Odd Fellows, the Patriotic Order Sons of America, the Royal Arcanum and the Junior Order of United American Mechanics. His church is the Myrtle Street Methodist Episcopal, and his politics are Republican.

Mr. Fuller married Laura E., daughter of Miles and Sarah (Burleigh) Swingle, of South Canaan, Wayne county, Pennsylvania, and his children: 1. Howard, born January 2, 1890, deceased. 2. Jennie, born January 6, 1892. 3. Cora, born September 28, 1893.

---

#### MICHAEL NORTON

Michael Norton was the first "newsboy" who ever shouted the sale of a newspaper on the streets of Scranton. On the opening of the southern division of the Lackawanna Railroad in 1857, "Mike" Norton came to Scranton with a bundle of New York papers under his arm. His first work in this neighborhood was on the trains of the Lackawanna, stopping over a day or two each week to peddle papers in this young borough of Scranton. His energy was so attractive that he soon made a host of friends. He seemed to be always on the run, expending his last minute to reach another customer. His shrill call of "All the New York papers" was a novelty then in the village, and was in the latest form of the metropolitan "Newsies." His quick nervous step—a half run—acquired during these news hustling days, remained a characteristic of him through all his after years. He never appeared to have a moment's leisure. He came to Scranton when eight years of age. In 1875 he was a prosperous bookstore merchant at Nos. 106-108 Lackawanna avenue. Later he acquired a property in the block between Wyoming and Penn avenues, on the south side. He continued in the book business for more than forty years, during which time he had the misfortune to be burned out twice by conflagrations in adjoining buildings.

Michael Norton was born in Ireland, December 6, 1842. He came to

America with his parents in 1848. He married Mary E. Jones, of Brooklyn, New York, by whom he had children, Edith M., Harold R., Grace A. He joined the First Presbyterian Church during the pastorate of Rev. Dr. Logan, and was among those who left the First Church to organize the Second Presbyterian Church in 1874, and he continued an active member and supporter of the Second Presbyterian Church until his death, January 17, 1910. Mr. Norton was a remarkable man in many respects, born in the poverty of the humblest of Ireland, he by energy and sobriety, and intelligence in business, worked his way well up in the world towards affluence. He was self-educated and practically a self-made man.

---

### JOHN B. RADER

Rader has been a common and familiar name in Lackawanna county since the days of the first founding of the city of Scranton, the grandfather of John B. Rader having been an early settler in that region. The family is of German descent, the father and grandfather of John B. Rader having been born in Bavaria. Philip Rader, father of John B. Rader, was born in Durkheim, Bavaria, Germany, in 1844, and as a lad came to the United States, making his home at East Mauch Chunk, Pennsylvania, establishing in the undertaking and furniture business. In 1891 he sold his property and business interests and moved to Scranton, operating, in partnership with his son, John B., a hotel at No. 522 Lackawanna avenue, and so continued until his death, May 29, 1901. He married Ellen, daughter of Patrick and Ellen McFadden, her father dying in Ireland, his birthplace, she and her mother making the voyage to the United States. Philip and Ellen (McFadden) Rader were the parents of: James, a resident of Buffalo, New York; William, deceased; Mary, deceased; Kate, deceased; Philip, deceased; Kate, deceased; Edward, resides in East Mauch Chunk, Pennsylvania; John B., of whom further; Anna, married John Rink, and resides in Scranton, Pennsylvania; Joseph, resides in Scranton; Philip, a resident of Scranton.

John B. Rader, son of Philip and Ellen (McFadden) Rader, was born in East Mauch Chunk, Pennsylvania, December 14, 1870. He was educated in the parochial schools of that place, later serving an apprenticeship at the carpenter's trade and pursuing that occupation until 1900. In that year, upon the death of his brother, William, he with his father assumed the management of the former's hotel at No. 522 Lackawanna avenue, and conducted this house until April 1, 1912. On that date he moved to his present excellent location at No. 406 Spruce street, where he purchased the building and business of the Arrow Cafe and Hotel, of which business he is the present successful proprietor. Mr. Rader holds membership in the Knights of St. George, St. Mary's Bund, the Junger Mannerchor, the Liederkranz, St. Peter's Society, the Old Guard, the Fraternal Order of Eagles, the Benevolent and Protective Order of Elks, and with his family belongs to St. Mary's Roman Catholic Church. Politically he is an ardent Democrat. Mr. Rader married Anna Sachwender, daughter of Frank Sachwender, and is the father of three sons, Philip, Frank, John.

---

### ROBERT FERRIS POST

The life story of Robert Ferris Post, at the time of his death the leading drayman of Scranton, is the tale of the triumph of perseverance and the victory of determined and unswerving integrity. And it is not surprising that in the exercise of these virtues their concomitants should be prosperity,

happiness, prominence and respect, both of self and of others, while added to these were the true-hearted affection of his many friends and the blessing of the devoted love of his family. For if such be true of a man, nothing is wanting to make his life complete and his happiness sublime, and for such a one to be called from his activities while in the prime of life, in the height of his usefulness, leaves a riddle that naught but the inscrutable will of the Master can fathom.

Robert Ferris Post was a descendant of the old New England family whose home was in Connecticut, where many of the name have gained fame in all branches of human endeavor, and whence branches have sprung that have reached to all parts of the country.

Jacob Post, father of Robert Ferris Post, passed the greater part of his life in Leslie, Pennsylvania, where his death occurred in 1875. He married Electa Bell, daughter of Colonel Bell, who gained his rank in the Northern service during the war of the Rebellion. Jacob and Electa (Bell) Post had children: Maggie, married a George Haddon, and resides in Minneapolis, Minnesota; Robert Ferris, of whom further; Bell, deceased; Ordie J., a resident of Forest Lake, Minnesota.

Robert Ferris Post was born in Leslie, Pennsylvania, March 29, 1867, died in Scranton, Pennsylvania, September 8, 1913. He was educated in the public schools of the place of his birth, and for several years lived on a farm, later moving to New York state and making his home with an uncle, Robert Bell. His connection with Scranton began in 1887, when he journeyed thither and entered the employ of J. D. Williams. He soon formed an association with Mr. Brown, a well known Scranton drayman. He was constitutionally so constructed that he derived no pleasure in being an employee, and although realizing that his beginning must be humble, he decided to establish an independent business, choosing draying as his line. His funds were sufficient to allow of the purchase of but one horse and wagon, and with this team as his entire stock in trade he began business, his stout heart and rugged decision having far more value in assuring his future success than his meager possessions. In the beginning of his career no commission was so small to deserve and receive a full share of his personal attention, and on this principle he constructed the massive business that at his death, in 1913, surpassed any other in the city. Into the fabric of his daily work he wove the strength and vigor of his powerful personality and received his returns in material prosperity. By his fellows he was accepted at his true value of earnestness, sincerity and sterling worth, and so conducted his business career that no one, competitors or confederates, could connect him with any associations not honorable and above-board, and none, realizing his desert, envied him his fortune. At his death his absence was regretted as the loss of a man who had learned the true secret of success, one whose cheery presence lightened the dreary burden of business life, and one whose companionship was beneficial and uplifting. His home life held the sacredness and sanctity engendered by pure devotion, and his wife and those of his blood only know the tenderness of his love and the deep sympathy of his nature. Mr. Post's popularity among those with whom he came into contact in business life is shown by his presidency of the Team Owners Association, and he was a member of the Scranton Board of Trade, the P. O. S. of A., No. 178, and the Masonic Order, in which he held the thirty-second degree. The part that he took in politics was always as a loyal Republican.

Mr. Post married, February 17, 1891, Carrie L., daughter of John F. and Mary E. (Dunsten) Sayer, of Moscow, Pennsylvania. John F. Sayer is a son of Horatio A. and Elizabeth (Fry) Sayer, who were residents of Frytown, a place named from the family of Elizabeth Fry. John F. Sayer is a veteran



of the Civil War, having enlisted in the Union ranks soon after Fort Sumter was fired upon and served throughout the entire four years, receiving, when peace was declared, an honorable discharge, leaving the army with the rank of sergeant. He is still living, aged eighty-one years, his wife, Mary E., a member of the English family of Dunsten and a descendant of Lord Dunsten. Children of John F. and Mary E. (Dunsten) Sayer: Eva, married G. F. Kramer, of Scranton; Carrie I., of previous mention, married Robert Ferris Post; Louise, married Albert Saunders, of Scranton; Cassie, married C. W. North, and lives in Stroudsburg, Pennsylvania; Florence, married Alton Chase; Lena, married Bert Stover, also married B. Roselle, all of Scranton; Chester, died in 1902; Harrison, a resident of Moscow, Pennsylvania. Children of Robert Ferris and Carrie I. (Sayer) Post: Bell M., born 1892; Mary S., 1894; Robert J., November, 1897.

---

### PHILIP HENRY WARREN

Originally an English family, the Warrens of this branch settled in Wales, whence in 1887 came Philip H. Warren, now an honored citizen and merchant of Scranton. By marriage the Warrens are connected with the Davis family of Wales, Anna Davis, maternal grandmother of Philip H. Warren, having been born in Breckinshire, Wales, daughter of a well-to-do lumber merchant. Harry Davis, a first cousin of Mr. Warren, was a colonel in the English army, served ten years in India, and witnessed the horrors of the Great Mutiny. Henry George Warren was born in England in 1839, moving to Wales when a young man. For the past forty-four years he has been employed at the Glamorgan Woolen Mills. He married Mary Ann, daughter of John Carter, of Wales, and had issue: Frances, deceased; Philip Henry, of whom further; Samuel Uriah, David Jeremiah, William John, deceased; Arthur Sidney, Mary Ann, Elizabeth Jane.

Philip Henry Warren was born at Merthyr-Tydfil, South Wales, October 22, 1865. He was educated in the public schools and remained in his native land until he had attained his majority. In 1887 he came to the United States, arriving on the steamship "Alaska" at New York City, the first day of May. He immediately came to Scranton, which has ever since been his home. His first position was as clerk in a grocery store at Providence, his next with Clark Brothers, the well known Scranton merchants, with whom he remained eight years. He then was with Jermyn & Duffy until Mr. Wentz purchased Mr. Jermyn's interest, next with the new firm, Wentz & Duffy, and then with Mr. Wentz, who purchased the Wentz & Duffy interest and continued the business as C. P. Wentz Company. After long years of service Mr. Warren purchased an interest and became a partner of Wentz, Warren & Company, on August 8, 1907. The firm continued in business until December, 1907, when Mr. Warren became president and treasurer of the Warren, Moran, Harper Company, wholesale confectionery, tobacco, and school supply dealers, one of Scranton's most successful and prosperous concerns. Mr. Warren is a lover of music and as a member of the Scranton Choral Society sang with the picked representatives of the Society at the Festival held in Pittsburgh, July 4, 1913, the Scranton delegation winning the \$5,000 prize. This was the second time the Choral Society had won first prize at a national singing contest, the other victory having been won in competition at the Louisiana Purchase Exposition, held at St. Louis. At that time Mr. Warren was vice-president of the Society and was one of the singers in both contests. He is also a member of the well known Schubert Quartette, the Liederkrantz, the Junger Mannerchor, the Doctor Parry Society, all of Scranton, and for the

past fourteen years has been soloist of the Elm Park Methodist Episcopal Church choir. For five years before coming to the latter church he had been soloist at St. Luke's. He is also prominent in the Masonic Order, belonging to Peter Williamson Lodge, No. 323, F. and A. M.; Lackawanna Chapter, No. 185, R. A. M.; Coeur de Lion Commandery, No. 17, K. T., and Irem Temple, Nobles of the Mystic Shrine. He is a member of the Heptasophs and of the Commercial Travelers Association, of Utica. In politics he is a Republican, and in religious faith a communicant of the Elm Park Methodist Episcopal Church. He married Annie, daughter of John Roberts, of Doulais, South Wales.

---

#### HENRY C. MANCHESTER

The career of Henry C. Manchester embraces a life time of service in transportation work in connection with railroads. The various grades of road services, from water boy to engineer, have been filled by him with a fidelity and steadfastness of purpose that have marked as well his services in supervisory positions.

His father, Albert B. Manchester, and his grandfather, Dr. John Manchester, were both residents of Vermont, their occupations and professions being those of carpenter and physician, respectively. In Randolph, of that state, Henry C. Manchester was born on April 28, 1865. He attended the public schools of Randolph and later the State Normal School. His first employment was with the Central Vermont Railroad, in the capacity of water boy, and later as freight brakeman. He then accepted a position as passenger brakeman on the Boston & Lowell Railroad in Massachusetts, being promoted to fireman and remaining as such for three years. His next advance was to engineer and in this highest department of road service he was engaged for twelve years, in that time creating a reputation for dependability and caution that made him one of the most valued engineers of the road. The custodian of hundreds of lives throughout that time, his first thought was ever for their safety and in the many trying crises of railroad life he acquitted himself with credit. Never a reckless driver of his massive steed, he yet obtained from it every ounce of power and all possible speed, no engineer on his division running more closely to schedule than he. After his long term as engineer he was made road foreman of engineers, leaving the employ of the Boston & Lowell Railroad to identify himself with the Boston & Maine Road as master mechanic, with headquarters at Worcester, Massachusetts. In 1901, when the Boston & Maine absorbed the Fitchburg Railroad Company, he was made master mechanic with headquarters at Mechanicsville, New York, so continuing for five and a half years. Resigning from the employ of this company he accepted a position with the Maine Central Railroad as assistant superintendent of motor power at Portland, Maine, and after five years was promoted to assistant superintendent of transportation, having five division superintendents under his direction. A year later he located at Scranton as superintendent of motor power and equipment for the Delaware, Lackawanna & Western Railroad, and there still resides, holding the same position in the company's employ. Because of his steady advance in railroad work and the vast fund of knowledge and experience he has acquired in his contact with the different departments of a system, Mr. Manchester is ideally qualified for the post of trust and responsibility he now occupies. Ever watchful in the road's interest, his division of the system is constantly keyed up to the highest pitch of efficiency, and the fortune and prosperity of the road, as far as his department is concerned, is safely guarded. An

important link of the vast chain, the strength of the whole is great, if no part is weaker than that over which he has supervision. Mr. Manchester affiliates with the Masonic Order, belonging to Lodge, Chapter, Commandery and Shrine.

Mr. Manchester married, June 17, 1888, Ella, daughter of Nicholas Jeannot, of Nashua, New Hampshire. Children: Bernice S., and Florence E. The family home is at No. 33 Quincy avenue.

---

### JOHN U. SCHWENKER

Wurttemberg, Germany, a prosperous province of that land, has furnished Pennsylvania a vast number of citizens who have contributed to the prosperity of that commonwealth as their fathers and ancestors strove for that of the homeland. The Schwenkers, represented in Scranton by John U. Schwenker, alderman from the nineteenth ward of the city, are a family who conform to this description and take their place in this category.

John George Schwenker, father of John U. Schwenker, was born in Zavelstein, Wurttemberg, Germany, January 8, 1832. Learning the baker's trade he remained in his native land until 1885, in that year coming to the United States, where he engaged in the business he had learned in Germany, working actively until his death, January 12, 1904. His father, Michael Schwenker, was a farmer, owning land near Zavelstein, which he cultivated, and where he reared his three children, Anna, Ulrich and John George, to maturity. John George Schwenker married Rosie, daughter of Gottlieb Mussle, and had children: George F.; John U., of whom further; Rosie, married a Mr. Hohman; Margaret, married a Mr. Getz, a resident of Scranton; Catharine, married a Mr. Holderle, a resident of Colden, New York; William, a baker established in business in Buffalo, New York; George G., a baker of Honesdale, Pennsylvania.

John U. Schwenker, son of John George and Rosie (Mussle) Schwenker, was born in Zavelstein, Wurttemberg, Germany, August 9, 1864, and for eight years attended the high school of his native city, a worthy institution offering high educational advantages. When the time arrived for him to choose a trade he expressed a preference for that of tailor and was thus employed until he was sixteen years of age, when he journeyed to the United States, taking passage on the German Lloyd Line steamer "America." The vessel left its German harbor on April 19, 1882, but did not arrive in New York until the 12th of the following month, the "America" having been partially disabled by a collision with an iceberg which had drifted southward into the path of navigation, fortunately with no such disastrous results as attended a similar accident thirty years later to the ill-fated "Titanic." On February 17, 1885, Mr. Schwenker retraced the route he had traveled three years before, hastening to the deathbed of his mother, who died after a lingering illness, her son returning to the United States. Obtaining employment with the leading tailor of Scranton he remained with him until 1886, when the association was discontinued by the death of the owner. Mr. Schwenker then purchased the business, which was located at No. 319 Center street, from the heirs of the estate, and moved his store to No. 311 Lackawanna avenue. Here he continued in successful operation until 1907, in February of which year he was elected alderman of the nineteenth ward, and re-elected November, 1913, nominated by the Republicans and endorsed by the Democrats; term expires in 1920. Subsequently he again changed his place of business to its present location at No. 625-27 Pittston avenue, where he performs with eminent satisfaction the duties of his civil office. Socially and

fraternally Mr. Schwenker has prominent position, holding membership in Schiller Lodge, No. 345, F. and A. M.; the Knights of Malta; the Knights of the Golden Eagle; the Modern Brotherhood; the Workmen's Society; the German Order of Haru Gari; the Koelsch Century Club; the Schwaben Verein, of which he has been president for twelve years; the Junger Mannerchor, to which he has belonged since 1900; also the Scranton Sangerbunde, of which he is president at the present time. He is a member of the Church of Peace, and politically is in accord with the principles of Republicanism.

Mr. Schwenker married, June 28, 1886, Mary, daughter of Ulerick Schwenker. Children: Charles W., Frederick L., Clara, Edward, Marie.

---

#### PAUL SILAS WALTER

Michael Walter, grandfather of Paul Silas Walter, was born in Germany, and emigrated to the United States in 1857. He came directly to Scranton, where he made his home until his death in 1905. He married Brigetta Hemmeler, and had children: Elizabeth, Brigetta, Michael, John, George. Michael Walter Jr. was employed as a machinist by the Delaware, Lackawanna & Western Railroad Company until his death in December, 1901. He married Rose, a daughter of Christopher Steinle, and they had children: Charles Wesley, deceased; Paul Silas, of whom further; George A., Arthur A., Ella E.

Paul Silas Walter was born in Scranton, Pennsylvania, June 26, 1877. His elementary education was acquired in the public schools of his native city, which he attended until he reached the age of twelve years, when he decided to go to work. In 1892 he entered the employ of attorneys, Milton W. Lowry and C. H. Von Storch, where he remained for a period of four years. Having decided upon the study of the law he registered, in 1896, as a student with the law firm of Watson & Zimmerman. One year later he accepted a position with the International Salt Company, and has been connected with this company in various capacities since that time. When Mr. Walter first joined this company, he came under the direct supervision of the president, the late Edward L. Fuller, who was not slow to appreciate the industry and integrity of his young employee and advanced him from one position to another, making him his private secretary, and the assistant treasurer of the related companies. Mr. Walter also became private secretary to Mr. Mortimer B. Fuller who, upon the death of his father, became president of the salt companies.

Mr. Walter has always taken a personal and enthusiastic interest in local and state politics, and is a young man of forceful personality and recognized political sagacity. For two years, 1901-03, Mr. Walter was corresponding secretary of the Pennsylvania State League of Republican Clubs. For several years he was secretary of the Lackawanna Hospital in Scranton, and when this institution was taken over by the state, Mr. Walter was continued as secretary of the State Hospital. Upon the death of the late W. F. Halstead, he was appointed a member of the board of trustees, and holds this office at the present time. He was appointed civil service commissioner by Mayor John Von Bergen, but resigned this office in 1912 because of political differences, the mayor espousing the cause of the Progressive Republicans. He is a member of the Order of Free and Accepted Masons, and his religious affiliation is with the Second Presbyterian Church, and he takes an active interest in all matters affecting the progress and welfare of the community. He is also a member of the Scranton Club.

Mr. Walter married, December 31, 1902, Jessica, a daughter of Dr. Eman-

uel and Matilda (Hammer) Betterly, of Wilkes-Barre, Pennsylvania, and has children: Helen M., born October 14, 1903; Paul Silas Jr., born December 30, 1909.

---

GEORGE L. JONES

This line of the Welsh family of Jones was founded in the United States by Daniel Jones, born in Wales in 1799, who came to this country subsequent to the death of his wife, here finding employment in the mines. He was a son of William Jones, a life-long resident of the homeland, who had children: 1. Thomas, immigrated to the United States, passed a few years in the city of Scranton and then returned to his native land. 2. Daniel, of previous mention. 3. Ann. 4. Henry, a resident of Carbondale, Pennsylvania, died from injuries received at mine labor; married Martha Fox and had children. 5. James, came to the United States, remained for a time in Scranton, Pennsylvania, and then returned to his home in Wales; married and had children. 6. Benjamin, met an accidental death while working in the mines; married Elizabeth Jones, who now lives in Wales. 7. William, married Phoebe Harris; he was a soldier of the Union army in the Civil War, belonging to the One Hundred and Thirty-seventh Regiment Pennsylvania Volunteers, of which his brother, Benjamin, was also a member, and died in a Soldiers' Home in Virginia. Daniel Jones married (second) Elizabeth Phillips and had children: 1. William P., a moulder, resides in Scranton, retired; married Elizabeth Havard and has children, James, Edgar, William; he enlisted in Company I, Fifty-second Regiment Pennsylvania Volunteers, and fought in McClellan's army, being wounded and sent home to recover; health and strength regained he again enlisted in the Union army, this time in the Seventy-seventh Regiment Pennsylvania Volunteer Infantry, and after seeing considerable service was again disabled and sent home from New Orleans. 2. Henry D., for several years an employee of Richards & Howell, merchants of Scranton, later establishing in the grocery business independently and afterward retiring; married Mary Lewis and had children, Lewis and Walter. 3. Ann, married David Jones, and has one son, Daniel. 4. ———, a tinner of Hyde Park; enlisted in the Seventy-seventh Regiment Pennsylvania Volunteers, and after eight months' service was discharged for physical disability and sent home with his brother, William P., from New Orleans, his death occurring eight months after his arrival, caused by illness contracted in the army. 5. Ebenezer, a graduate of the Scranton High School; married Martha Jones. 6. Roderick, of whom further.

(III) Roderick Jones, son of Daniel and Elizabeth (Phillips) Jones, was born at St. Clair, Schuylkill county, Pennsylvania, January 14, 1839. Until he was ten years of age he was a student in the public schools of Carbondale. For the three following years he was employed on a farm, then for two years performed mine labor, at the end of that time accompanying his father to Scranton, and there entering the mines of the Lackawanna Iron and Coal Company. After two years he became driver boss in the mines, and was subsequently placed in charge of the pumping engine. In August, 1862, he became a member of Company I, One Hundred and Thirty-second Regiment Pennsylvania Volunteers, enlisting under the nine months' call, and was at once plunged into active service. On December 10, 1862, while engaged with the enemy, Mr. Jones was struck in the arm by a Minie ball, the bullet entering his arm just below the shoulder. Amputation was necessary to save his life, and after the operation he was sent to his home. Recovering from the ill effects of this accident, Mr. Jones secured a position as watchman at

the Diamond Mine, and after holding this place for three and one-half years became steam pump operator at the Hampton Mines, where he remained for one and one-half years. Receiving an appointment as constable for ward five, he was so employed for twenty years, resigning therefrom to enter fire insurance dealing in the employ of the Phillips & Holmes Company. This is the line in which he now continues, having in 1912 formed alliances with the Ohio Farmers', the Williamsburg City (New York), and a Chicago insurance company. He married Elizabeth, daughter of George and Mary (Williams) Lewis, and has one son, George L., of whom further.

(IV) George L. Jones, son of Roderick and Elizabeth (Lewis) Jones, was born in Scranton, Pennsylvania, June 7, 1874. Until he was fifteen years of age he attended the public schools of Scranton. His business life began as his father's associate in the insurance business, after which, in 1891, he became connected with Williams & Company, No. 702 South Main avenue, with which concern he is still identified. Two years after entering the employ of Williams & Company he took a business course at Factoryville, Pennsylvania, then returned to his duties. That these, in the various capacities in which he has served this company, have been thoroughly and capably performed is assured by the present important position he now holds in the company's organization, that of manager. He is an alert, progressive and energetic business man, ever striving with all of his effort for the preservation of the interests of his employers. Mr. Jones is a thirty-second degree Mason, his lodge, Hiram, No. 251, F. and A. M., and he also belongs to Irem Temple, Ancient Arabic Order Nobles of the Mystic Shrine. His political party is the Republican, his church the Bethania Welsh Presbyterian.

Mr. Jones married Margaret, daughter of the late Edward James, mine foreman of the Dodge Colliery Company. Among the children of the late Edward James are Hon. Edward James Jr.; John R. James, assistant superintendent of the Delaware, Lackawanna & Western Railroad; Mrs. Thomas G. Collins; Gwen James.

---

#### CHARLES HAMPEL

It has been almost uniformly true that in the growth of a city, the class of men whose profits are most reliable and who are reasonably certain of a prosperous continuance in business are the merchants. Real estate dealers may lose their all by the city's growth extending in another direction; manufacturers may be handicapped by inadequate transportation facilities; climatic conditions may hinder the work of contractors; but under all and any conditions, people must be clothed and must be supplied with household commodities. One of Scranton's most prosperous merchants, whose career has been molded entirely in the city, is Charles Hampel, president of the Finley Company. The necessity for merchants was the only favor granted him by fortune, his position in the mercantile world being the result of extraordinary application to duty and unusual energy, coupled with a sharp ambition not to be satisfied except by a position of superior station.

Peter Hampel, the emigrant of the name, came to the United States from Germany. He was equipped with the usual German training, a deep knowledge of military discipline and tactics in case of war involving the Fatherland, and a knowledge of a trade just as deep, so that he might never be a dependent upon the government. When he came to Scranton, in 1857, he brought with him his wife and daughter, and there was constantly employed until his death, first with the Iron and Coal Company, and next with the Delaware, Lackawanna & Western. Both he and his wife were members of the German Pres-

byterian Church, and he belonged to Alliance Lodge, Independent Order of Odd Fellows. He married Charlotta, daughter of John Weyand, a native of the same part of Germany whence he came. Children: Lena, married John Lentes, of Scranton; Charles, of whom further.

Charles Hampel was born in Scranton, Pennsylvania, April 22, 1861. He obtained his education in the public schools, and when he was only fourteen years of age began his long and successful career in the mercantile business as cash boy in the employ of Moore & Finley, at the time the most important of the city's mercantile houses, and has been connected with this firm in divers capacities until the present time. Originally established by Thomas Moore, the firm was enlarged by the admission of Mr. P. B. Finley, and when the partnership of Moore & Finley was dissolved, Mr. Finley opened a store at the location now occupied by Michael Bosak. During all this time, Mr. Hampel continued in the employ of the different firms, and in 1906, when the corporation, the Finley Company, was formed, he and Thomas A. Lavin, besides the officers, P. B. Finley, president, T. D. Shiver, vice-president, H. J. Cooper, secretary and treasurer, were partners incorporating the business. The present officers are Charles Hampel, president, T. D. Shiver, vice-president, and Thomas A. Lavin, secretary and treasurer.

Mr. Hampel married Elizabeth, daughter of Henry Bosley, of Jeffersonville, Sullivan county, New York. Both he and his wife attend the Presbyterian church. The rise of Mr. Hampel in his chosen occupation is one upon which he deserves hearty congratulation. The period of time from 1875 to 1913 has seen him progress from cash boy to the presidency of the firm he served in the first named capacity. Thirty-eight years of toil, of constant striving for a goal far ahead, often in the face of discouragement and seemingly insurmountable barriers, are years full of memories when looked upon from the height of the once-distant pinnacle. It is the old, old story of the success that meets persistent and intelligent effort, one as new as it is old, and as wonderful as common-place.

---

#### THOMAS DAVID JAMES

Thomas David James, alderman of the second ward of the city of Scranton, descends paternally and maternally, from Welsh ancestors, the first of his paternal line coming to the United States in 1865. Though fifty years covers the period spent in this land by this branch of the James family, that length of time has given birth to Thomas David James, American in birth, thought and in every aspect of his nature, a worthy representative of his district upon the board of aldermen. His grandfather was David James, who spent his entire life in Wales and was the father of: Theodore D., Reese, John, Griffith, Thomas David, of whom further, Zachariah, Eli, Jane.

(11) Thomas David James, son of David James, was born in Wales and came to the United States in 1865, settling first at Hyde Park, Pennsylvania, later moving to Taylor, where he became fire boss in a mine. He afterward became a miner and was the first man to enter the Taylor shaft after its completion, his son, David, being the first driver to take a team into the great shaft. In 1894 Mr. James moved with his family to Providence, Pennsylvania, where he spent his latter years, his death occurring in 1900. He married Margaret, daughter of William T. Jones. Her father was a native of Wales, and after coming to the United States resided in Taylor, Pennsylvania. He was a far-sighted and practical man, realizing full well the advantages he enjoyed in this country, and yet was filled with a tender sentiment for the land of his birth, which he visited on four different occasions after leaving it for the

first time. Children of Thomas David and Margaret (Jones) James: Sarah, David, Margaret, Mary Ann, Elizabeth, married Hon. Lewis H. John, member of Congress, Jane, Edith, Ida, Thomas David, of whom further; Gertrude.

(III) Thomas David (2) James, son of Thomas David (1) and Margaret (Jones) James, was born at Taylor, Lackawanna county, Pennsylvania, April 22, 1877, and was a student in the public schools of his birthplace, completing the high school course, and receiving a diploma of graduation; he then entered Wood's Business College, from which institution he was graduated in 1896. Leaving school he accepted a position as bookkeeper in the quarry at Hyde Park, and had been employed in this place but six months when he was promoted to the office of general manager. This position he held until failing health compelled entrance into some less strenuous occupation, and for the next four years he taught school in various parts of the county. Strengthened in body by the outdoor exercise in which this occupation gave him time to indulge, he entered one of the Scranton mines as breaker boss, and after two years was appointed mine inspector, of which office he was the incumbent until 1912. In this latter year, as a Republican he was elected alderman for the second ward of Scranton, the largest ward in the commonwealth of Pennsylvania outside of the cities of Pittsburgh and Philadelphia.

Mr. James, during his term of office, has shown himself a magistrate of wisdom and sound judgment, and has won the approbation and commendation of those familiar with his official career. He is known as a man of honorable principles, to which he constantly adheres, and is a public servant whole hearted in his devotion to the trust placed in him. Mr. James is a communicant of the Memorial Baptist Church, and holds membership in the Junior Order of United American Mechanics.

---

#### WILLIAM H. HAGEN

Henry Hagen was born in Hagen, Germany, and when eight years of age came with his parents to the United States, settling at Honesdale, Pennsylvania, where he attended the public schools. As a young man he learned the trades of blacksmith and carriage builder, and was employed, soon after completing his apprenticeship, by the Delaware, Lackawanna & Western Railroad as tool dresser. He became a resident of Scranton, and was one of the first to enlist in the Thirteenth Regiment Pennsylvania National Guard, of which he was for many years a member. He affiliated with the Masonic fraternity. He married Marion, daughter of William Walsh, of Honesdale. Children: Louise, married George B. Carson, of Scranton; William H., of whom further; Frank; Gillam, married Andrew Wicks, a resident of Scranton. Mr. and Mrs. Hagen were members of the Simpson Methodist Episcopal Church.

William H. Hagen, son of Henry and Marion (Walsh) Hagen, was born in Scranton, Pennsylvania, September 27, 1861. He obtained his early education in the public schools of Scranton, and when a lad spent several years in Newark Valley, New York, whither his family had moved and where they remained until 1873, when they returned to Scranton. In Scranton Mr. Hagen entered the employ of Moore & Finley, merchants, and obtained much valuable experience in and knowledge of the mercantile business, training of the greatest benefit to him in his later life. In 1894 he and Joseph A. Mears established the business which has since become the Hagen & Wagner Company, as Mears & Hagen, their line being then, as now, dry goods and men's and women's furnishings. From a concern employing six persons, their sales force now numbers seventy-five, and in September, 1914, they moved into their newly







W. P. Loring

remodeled store on Washington avenue, now occupied by the Prendergast firm and the Jones' Tea Company. Mr. Hagen serves the Asbury Methodist Episcopal Church as a member of the official board and as trustee, also superintendent of the Sunday school. He is a director of the local branch of the Young Men's Christian Association. His only fraternal connection is with the Masonic Order, in which he holds the thirty-second degree, and is a member of Irem Temple, Nobles of the Mystic Shrine.

Mr. Hagen married Carrie, daughter of William Munson. Children: Helen, married Beland Marsh, a resident of Scranton; Hoadley, a graduate of the University of Pennsylvania, class of 1913.

---

#### WILLIAM S. LIMING

Descendant of an old Pennsylvania family long seated in Philadelphia, Mr. Liming is thoroughly Pennsylvanian, although a resident of Scranton for only a decade. He has, however, completely absorbed the Scranton spirit and as one of the foremost workers in the world of electricity gained a solid footing among the men of progress in the city. He is a grandson of William and Annie Liming, of Philadelphia, and a son of John Liming, who was born in Philadelphia, where he was engaged until his retirement in the wholesale and retail oyster and game business. He married Myra T. Schurman; children: Ridie, Belle, Annie, Lizzie, John, William S.

William S. Liming was born in Philadelphia, Pennsylvania, April 27, 1865. He was educated in the public schools of the city, obtaining a good preparatory training, then entered the University of Pennsylvania, where for three years he pursued a regular scientific course. Leaving the university he became an electrical worker, beginning as a helper, but rising through the grades of promotion in that business until he was superintendent of the plant in which he began, having general supervision over all departments, continuing until 1902. In that year he came to Scranton as electrical engineer for the Scranton Electric Company, and in 1913 succeeded D. C. Schain as general superintendent, which position he most efficiently fills. He is a member of Lodge, Chapter, Council and Commandery of the Masonic Order, and a communicant of the Protestant Episcopal Church.

Mr. Liming married, May 18, 1886, Ella M., daughter of William Barelay, of Philadelphia. Children: Gertrude and Grace, twins, born August 2, 1888; William B., September 3, 1891; Charles R., October 4, 1897.

---

#### EDWARD G. SIMONS

The connection of Mr. Simons with the city of Scranton, which began in 1906 as district manager of the Bell Telephone Company, was a fortunate one for the city, as from his coming dates an era of greater efficiency, a largely extended and greatly improved service. This result is one not surprising to his friends nor to those who are familiar with the fact that his entire business life has been spent in the service of the Bell Company and that he can qualify as an expert in any department of the company's business.

Mr. Simons is a son of Edward Fletcher and Isabella (Gillespie) Simons, and is a descendant of the emigrant from the North of Ireland, who was one of the log cabin pioneer settlers of Beach Grove, Wayne county, Pennsylvania, in 1806. Edward F. Simons was a merchant all his active life, which ended May 23, 1912, at the age of seventy-five years.

Edward G. Simons was born in Plymouth, Pennsylvania, April 8, 1872. He was educated in the public schools and at Wyoming Seminary. On

finishing his years of study he entered the employ of the Bell Telephone Company as a collector in Wilkes-Barre. Proving his ability in that field Lackawanna, Wayne, Pike and Monroe, with headquarters' office at Scranton as local manager. After three years in the latter position he was still further advanced and made district manager, his territory covering the counties of Lackawanna, Wayne, Pike and Montrose with headquarters' office at Scranton. This position he fills not only to the complete satisfaction of his company, but to the greater benefit of the telephone users of the district. He is a member of the Scranton Board of Trade, serving on the publicity committee.

Mr. Simons married Mrs. Isabella Bradley, of Detroit, Michigan. Mr. Simons is president of the Simons family reunion and has letters dating back over one hundred years showing the landing of the family in this country, coming from the northern part of Ireland. They located in Wilmington, Delaware, and later removed to Pike county, Pennsylvania, where they were among the first pioneers, living in the rude log huts of those primeval days.

---

#### HENRY HESSINGER

In a list of the merchants of Scranton of a quarter of a century ago would be found in a prominent place the name of Henry Hessinger, deceased, furniture dealer and proprietor of an undertaking establishment. He was a son of Theodore Hessinger, born in Germany, May 11, 1823, where he grew to maturity and was married. Immigrating to the United States with his wife and family, he was for a time a resident of Brooklyn, New York, later moving West and engaging in work at his trade, that of cabinet-maker. Moving to Scranton, Pennsylvania, he obtained a position in the car works, performing the fine carpentering work on the interior of the passenger coaches, and was thus engaged for the remainder of his active life. His first wife died and for his second wife he married, in Brooklyn, New York, Caroline Engleskirscher, born February 22, 1833, and had children: 1. Louise, deceased. 2. Henry, of whom further. 3. George, a cigar-maker of Meadville, Pennsylvania. 4. Theodore, a boiler-maker of Cleveland, Ohio. 5. William, a harness-maker of Red Bank, New Jersey. 6. Susan, married Henry J. Fenne, of Scranton, and has children: Archibald, Carrie, Albert, Leroy, Merine, Elma. 7. Minnie, married Frank Washburn, formerly of the firm of Washburn, Williams & Company, now of Denver, Colorado. 8. Annie, deceased. 9. Carrie, deceased. 10. Adam, deceased. 11. Christina, deceased. 12. Louise, deceased. 13. Kate, deceased.

Henry Hessinger, son of Theodore and Caroline (Engleskirscher) Hessinger, was born in Sheboygan, Wisconsin, December 29, 1855, died in Scranton, Pennsylvania, September 28, 1890. He was four years of age when his parents moved from Wisconsin to Scranton, and he was educated in the public schools of that city, learning his father's trade after finishing his studies. He was afterward employed with the elder Hessinger in the car works, finishing the interior of the coaches, and in 1885 established in the furniture and undertaking business, continuing so for five years until his death. He was a singer of talent, possessing a voice of rare quality and sweetness, and long sang in the choir of the German Presbyterian Church, of which he was a member. He was a member of the Scranton Saengerbunde, and was identified with the Independent Order of Odd Fellows and the Patriotic Order Sons of America. Mr. Hessinger was well-liked among his business associates and was prospering in business, his early death cutting short what promised

to be not only a business career of unusual success but a life of usefulness and service.

He married, in 1879, Margaret, born in 1855, daughter of Charles Kiefer, born April 15, 1827, and Barbara (Kaufman) Kiefer, born January 27, 1833. Her parents were both natives of Germany, coming to the United States unmarried in 1850, having been unacquainted in the homeland. They were married in Honesdale, Pennsylvania, in 1853, she a daughter of Frederick Kaufman, who came to Honesdale from Germany, meeting his death in a railroad accident. Children of Charles and Barbara (Kaufman) Kiefer: 1. Margaret, of previous mention, married Henry Hessinger. 2. Anna Mary, born in 1861; married Frederick New, deceased, and had children: Frederick and Charles. 3. William C., deceased. 4. Charles Jr., deceased; married Kate Miller, and had children: Charles, Margaret, Madeline. 5. John, a drayman of Scranton; married Mary Schunk, and had children: Anna, Mamie, Carrie, Fred, Matilda, Mildred, Henry, John. 6. Henry, married Louise Eberhardt, of Honesdale, Pennsylvania. Children of Henry and Margaret (Kiefer) Hessinger: 1. William C., born August 21, 1881; secretary of the Citizens' Building and Loan Association; married Carrie Naher, and has one son, Paul, born September 1, 1908. 2. Frank T., born March 24, 1883; married Katie, daughter of Philip Kirst, a former street commissioner, and a sister of William Kirst, the present city commissioner, and has children, Henry P., born August 2, 1906, and Caroline M., born July 17, 1909. 3. Edward R., born July 27, 1889; a clerk in the Globe Warehouse; married Louise Scheuer, and has children: Edna, born June 22, 1911, and Robert, born September 23, 1912.

---

#### FRANK ZIVATAS

There are probably few citizens of the United States of foreign origin, particularly of the younger generation, who retain such deep devotion for uplifting their own people and the land that gave them birth, or devote themselves so whole-heartedly to keeping fresh its memory and traditions and to paying it due honor, as Frank Zivatas, president of the Lithuanian Alliance of America. He is a son of a Lithuanian farmer who married Lenora Barauski, and died in 1904. They were the parents of: Victoria, Elizabeth, Petronnel, Frank, of whom further, Isidor, and Mary, all residents of Lithuania with the exception of Frank.

Frank Zivatas was born in the village of Lataku, county Raseiniu, province of Kanno, Lithuania, December 10, 1874, and attended the public schools of his native land. Realizing the superior possibilities to be found in the United States, in 1893 he set sail for that land, arriving in New York City on April 14, proceeding westward to Chicago, Illinois, he remained in that city for three months. He then came to Scranton and until 1909 was there employed in the mines, in March of that year establishing in the wholesale liquor trade at No. 110 West Market street, in which location he has since conducted an extensive business. Mr. Zivatas, strong in the desire for self-improvement, has taken advantage of the excellent educational facilities of the city, having for one year attended St. Mary's private school, and was for eight years, from 1894 to 1902, a student in the night school of the Young Men's Christian Association, where he studied the English language and electricity, supplementing this instruction with a course in the International Correspondence Schools of this city. In 1909 he was elected president of the Lithuanian Alliance of the United States, and was re-elected in 1911. This society was organized in Plymouth, chartered in Luzerne county in 1886,

and in 1909 re-organized and its scope and influence widened. As president of this organization Mr. Zivatas has traveled considerably throughout the United States, visiting its constituent bodies and lecturing on its aims and purposes, as well as organizing new associations. In the latter work he has met with praiseworthy success, and is an interesting, forceful speaker. The headquarters of the Alliance are at No. 307 West Thirtieth street, New York City. Mr. Zivatas is also a member of the Lithuanian Benevolent Society and the Lovers of Fatherland Society. His political views are independent.

---

#### JOHN WAKEMAN DUSENBURY

A resident of Scranton since 1889, Mr. Dusenbury has a large acquaintance among the business men of the central city having been the local agent of the Travelers Insurance Company of Hartford, Connecticut, handling life and casualty lines. Occupying the same office for over twenty years indicates the stability of both company and agency.

Born at Great Bend, Susquehanna county, in 1860, where he represented the same company, he is now considered "one of the old guard" by "The Travelers," having a continuous agency connection of over thirty years.

Only child of John H., son of George Dusenbury, of Windsor, New York, and Caroline, daughter of Bradley Wakeman, of Laceyville, Pennsylvania. Mr. Dusenbury is a member of the Scranton Club, the Scranton Bicycle Club, local Masonic organizations, and is a vestryman of St. Luke's Protestant Episcopal Church. He has a large acquaintance throughout the country owing to many years' attendance at the meetings of the American Whist League and participation in many whist tournaments, and has assisted in winning two American championships in that sport.

Mr. Dusenbury married Nellie, a daughter of Jeremiah Hosford, of Friendsville, Pennsylvania, in 1888. Mrs. Dusenbury died at Scranton in 1896.

---

#### HERBERT E. BRADER

Herbert E. Brader, superintendent of the Scranton Pump Company, born in Scranton, Pennsylvania, January 25, 1858, is a son of Samuel Brader, who was one of a family of seven, consisting of: William, deceased; Simon, deceased, married and had children, Laura, Eudora, Howard, George, Bertha; George, deceased, married and had a son William, and daughter Eudora; Daniel, deceased, married and had children, Clarence, Ida, George; John, served in the Union army in the Civil War, a member of the company in which his brother Samuel fought, married and had children, Elmer and Edith; James, lives in Nebraska. The father of the above-named children was a pattern-maker and carpenter by trade, later in life retiring to the farm on which he died.

Samuel Brader was a resident of the city of Scranton, and enlisted in the Union army from that locality, participating in many of the most bloody conflicts of the war. He married Lydia, daughter of Jacob Smethers, of Scotch-Irish descent, and had children: 1. Luella, married John Washburn, of Wilkes-Barre, Pennsylvania, and has children, Franc, Eric, Pansy. 2. Herbert E., of whom further. 3. Samuel, married Barbara Weidman, and is the father of Luella, Ralph, Anna, Albert. 4. Lizzie, married Charles Tetter, and has children, Ella and Georgia. 5. Edward, married Jennie Thomas, of Scranton; they are the parents of one son, Samuel. 6. William, married

Emma Rollins, of Scranton. 7. Katherine, married James Tuttle, of Scranton; they have one son, Gerald.

Herbert E. Brader, son of Samuel and Lydia (Smethers) Brader, was born in Pittston, Pennsylvania, January 25, 1858. He studied in the public schools of Wilkes-Barre. He learned pattern-making in the iron works of that city and was so employed for a period of twenty-three years, from 1872 to 1905. In the latter year he came highly recommended to Scranton as foreman in the pattern-making shops of the Scranton Pump Company, serving in this capacity until October, 1910, when he was raised to the position of superintendent. Of this office he is the present efficient incumbent, ably discharging all of the duties that devolve upon him as head of the plant, and has raised the systems employed therein to the highest pitch of usefulness. Mr. Brader is a member of the Masonic Order, holding the thirty-second degree, belonging as well to Irem Temple, Nobles of the Mystic Shrine, of Wilkes-Barre. His political faith is independent.

Mr. Brader married Minerva L. Wagner, of Wilkes-Barre, Pennsylvania, the ceremony being solemnized October 29, 1879. They are the parents of: 1. Harry E., educated in the public schools of Wilkes-Barre; a piano-tuner; married Bertha Engel, daughter of George and Lydia (Pettibone) Engle; they have one daughter, Lydia Pettibone. 2. Charles, a pattern-maker; married Mary Brown, of Wilkes-Barre, and has one daughter, Minerva. 3. Stanley E., an employee of the Scranton Lithographing Company; married Mildred Grinnell, and has two children: Herbert and Stanley.

---

#### ELMER HENRY LAWALL

The development of the professional into the business man, and successful continuance in both departments is the unusual and commendable record of Elmer Henry Lawall, treasurer of the International Correspondence Schools of Scranton.

Allen Jacob Lawall, father of Elmer H. Lawall, was born near Easton, Lehigh county, Pennsylvania, July 23, 1841. Having acquired his education in the Moravian schools of that vicinity and at Bethlehem, he pursued mechanical work for several years, eventually entering the service of the Bethlehem Steel Company. He married Maria Toengeous, and of their seven children, four reached maturity: Elmer H., of further mention; Marie Antoinette, married C. J. Gapp, of Bethlehem; Helen Elizabeth, married Louis Bentley, of Beaver Falls, Pennsylvania, a mechanical engineer in the employ of the Armstrong Company; Madeline, married to Ralph H. Evans, editor, Alliance, Ohio.

Elmer Henry Lawall was born December 7, 1861. He attended the Moravian schools in Bethlehem, later entering Lehigh University, whence he was graduated C. E. in the class of 1882. The year after the completion of his college course and the attainment of his degree, he accepted a position in the engineering department of the Lehigh Valley Railroad Company, and was placed in charge of the company's mines at Hazleton, Pennsylvania. From this time until 1887 he was employed as chief engineer of the Beaver Brook, Silver Brook, Black Ridge, the J. S. Wentz, the Morea, and the New Boston Coal companies, and in addition to the service rendered these corporations was frequently in demand for advice in the engineering enterprises of other concerns. In 1887 he held the office of general manager of the New York, Susquehanna & Western Railroad and Coal companies, with headquarters in Scranton. From 1890 to 1898 he was general superintendent of the Lehigh & Wilkes-Barre Coal Company. In the latter year he became treasurer of the

International Correspondence Schools of Scranton, an office he fills at the present time with general satisfaction to all concerned. A careful and experienced business man, he handles the involved finances of the company in a capable manner, enjoying the confidence of all of his associates.

The multiplicity of Mr. Lawall's interests is shown by the following: He was consulting engineer of the Delaware, Lackawanna & Western Coal Company; is secretary of the Diamond Land and Improvement Company; vice-president of the Exeter Machine Works, Pittston, Pennsylvania; treasurer of the Square Deal Gold Mining Company, of Central City, Colorado; director of the Hazleton Iron Works; and expert engineer for several corporations of like character with those previously mentioned. Mr. Lawall's social connections are with the Westmoreland Club, University Club, of Philadelphia, Euclid Club, of Cleveland, Ohio, and the Country clubs of Wilkes-Barre and Scranton.

Mr. Lawall married, June 4, 1888, Carolyn, daughter of George Johns, deceased, who was a coal operator of Audenried, Pennsylvania. Children: Elise, deceased; Marie, living in Paris, France; Claire, attending school in Paris. Mr. Lawall has been called to the numerous positions of trust and honor that he holds through popular recognition of his fitness in his profession qualifying him for such distinction, and because of financial acumen so convincingly displayed.

---

#### LOUIS JOHN SIEBECKER

Louis John Siebecker is a member of a German family, a native of New York state, but since 1869 a resident of the city of Scranton. His father, William Siebecker, was born in Germany and was there educated, being early trained in the trade of cabinet-maker. He left his native land in 1845 and came to the United States in 1849, joining the vast horde that migrated westward in hope of sudden and rich wealth to be found in nature's treasure house, California. After a five years' quest for the precious metal he returned East, and shortly after his arrival in New York he married and took up his residence in Sullivan county, New York, the family home until 1869. In the latter year he and his family moved to Scranton, Pennsylvania, where for several years he was engaged in the grocery business, his store being located on Franklin avenue, later becoming a drayman. About 1904 he sold his business and retired from active life. He married Mary Lowenberg, a native of New York City, and had children: Annie, married F. J. Widmayer; Henry, Edward; Louis John, of whom further. Both parents are now deceased.

Louis John Siebecker, son of William and Mary (Lowenberg) Siebecker, was born in a log house on the home farm near Youngsville, Sullivan county, New York, December 26, 1860. He attended the country school nearby, and for one year was a student in a public school in New York City, and obtained the remainder of his education in the public schools of Scranton, and a private German institution in the same city. In 1876 he entered the employ of S. G. Kerr, a carpet dealer of Scranton, and after a seven years' connection with this merchant became a part owner of the business, which several years later was changed to Kerr & Siebecker. Mr. Siebecker, in 1895, was the prime factor in the organization of the Security Building and Savings Union and for fifteen years filled the position of treasurer, having since 1910 been secretary of that organization. Besides this business relation he is manager of the Electric Railways Advertising Company, not only in Scranton, but in several other large cities. He is a business man of tried abilities, valuable in whatever position placed, and both in connection with the company of which



he is an organizer and the Advertising Company he plays a prominent part. He and his wife are members of the German Lutheran Church, and he belongs to the Benevolent and Protective Order of Elks, the Scranton Liederkranz, the Junger Mannerchor, the Young Men's Christian Association, and is a Scottish Rite Mason. He has held active membership in the Liederkranz for thirty-three years, all of which time he has been in the chorus.

Mr. Siebecker married, at Honesdale, Pennsylvania, January 17, 1884, Jennie M. Dittrich, born in Honesdale, Pennsylvania, in February, 1862, daughter of Ferdinand and Dorothy Dittrich. Ferdinand Dittrich is a merchant, his line being hats and furs. Children of Louis John and Jennie M. vania; married Robert L. Reaves; Walter, a student in the Scranton High School; School; married Ernest S. Softley, and has one child, Kenneth. 2. Mary L., a graduate of the Darlington Seminary at West Chester, Pennsylvania; married Robert L. Reeves; Walter, a student in the Scranton High School. Mr. Siebecker's office is in the Mears Building, Scranton, Pennsylvania. His family residence is No. 531 Madison avenue.

---

#### HAYDEN H. ASHLEY

A native Pennsylvanian, a product of the public schools of that state and a New Jersey educational institution, Mr. Ashley has devoted his entire career, with the exception of a short space of time, to railroading, in which he is now engaged, Scranton always having been his place of business. He has risen through successive grades to a most important and responsible position with the Central Railroad of New Jersey.

Rollin T. Ashley, grandfather of Hayden H. Ashley, was born in Hampton, New York, October 22, 1803, on a farm on the west bank of Poultney river, nearly opposite the village of Fairhaven, Vermont. He taught school in the winter of 1826-27 at Bass River, Burlington county, New Jersey. He engaged in mercantile business at Blackman's Mills, Port Republic, now Atlantic county, New Jersey, and in the spring of 1831 removed to Brooklyn, Susquehanna county, Pennsylvania, where he succeeded his uncle, James Noble, in the mercantile business, and continued in trade for more than half a century. He was widely known as an active and influential Methodist, and was for many years a local preacher of that denomination. In 1866 he was elected associate judge of Susquehanna county and served to the end of his term, in 1871. He married, in what is now Port Republic, New Jersey, January 24, 1830, Roxanna Blackman, who died in Brooklyn, Pennsylvania, September 16, 1888. Children: James Ayars; Joseph Ralph; Nehemiah Blackman, of whom further; George Kennard; Sarah Eliza, married Captain Henry Francis Beardsley, of Montrose, Pennsylvania; Mary Adeline, married Rev. John S. Breckinridge, of Brooklyn, New York; Emeline; Horatio Hayden.

Nehemiah Blackman Ashley, father of Hayden H. Ashley, was born in Brooklyn, Susquehanna county, Pennsylvania, September 9, 1834. He left home before he was twenty and his active business career was devoted to railroad building and mercantile business. In 1854-55 he was with the civil engineering corps of the Delaware, Lackawanna & Western Railroad. In 1856 he was stationed at High Bridge, New Jersey, superintending the double tracking of the Central Railroad of New Jersey. The following year he built a section of track at Beach Haven, Pennsylvania, for the Lackawanna & Bloomsburg Railroad Company, now the Bloomsburg Division of the Delaware, Lackawanna & Western Railroad. In 1858 he was engaged on the Brooklyn Water Works, Brooklyn, New York. In 1862 he engaged in the mercantile business in Brooklyn, Pennsylvania, with his father, and the fol-

lowing year engaged in the same line in Alexandria, Virginia. In 1867 he came to Scranton and engaged in the produce business until his death, March 4, 1900, with the exception of the years 1874-75-76 spent in New Jersey building several miles of railroad known as the New York & Philadelphia New Line, now operated as part of the Philadelphia & Reading system, between Bound Brook, New Jersey, and Philadelphia, Pennsylvania. He married Mary Margaret Driesbach. Children: Emma B., married David H. Jenkins; Hayden H., of whom further, Annie, Daniel G., Ralph B.

Hayden H. Ashley was born in Brooklyn, Susquehanna county, Pennsylvania, February 4, 1864. He came to Scranton in 1867, at three years of age. He was educated in the public schools of Scranton, later finishing his studies at Pennington Seminary, Pennington, Mercer county, New Jersey. Until 1888 he was identified with the mercantile business of Scranton. In the latter year he entered the service of the Philadelphia & Reading Railway in the Scranton Station as telegraph operator and ticket clerk, continuing until that section of the road became the property of the Delaware & Hudson Company. He was employed in the same capacity by the latter road until May 1, 1888, when the terminal of the Central Railroad of New Jersey was completed in Scranton, at which time he became ticket agent in the new station. He was promoted to the cashiership of the freight department of the road in 1890, and on July 1, 1896, was appointed agent in charge of the freight traffic and passenger transportation, an office that he held until November 15, 1909. On that date he was placed in the position that he now holds, that of contracting freight agent, and since that time has discharged the duties of his office with an admirable ability and a thoroughness that leaves little to be desired.

His department in such a great manufacturing centre as Scranton is one of vital importance and one upon which hinges much of the prosperity of the road. Faithfulness and wise execution of the affairs that come within his province have marked his term of service and have made his relations the most happy and congenial and satisfaction has pervaded all of his contact with superiors and inferiors in position. His fraternal order is the Masonic in which he holds the Knights Templar degree, also belonging to the Nobles of the Mystic Shrine.

Mr. Ashley married, June 15, 1892, Daphna, daughter of George W. Twinning, of East Mauch Chunk, Pennsylvania.

---

#### WILLIAM DECKELNICK

The German family of Deckelnick has had nearly sixty years of residence in Scranton, that time all but covering the period those of the name have spent in the United States. The present representative of the family in Scranton, is William Deckelnick, whose grandfather, John, was a native of Germany and spent all of his hundred and four years in that land. John Deckelnick was a harness-maker by trade and followed that occupation until he had attained an advanced age, his strength and vitality having been preserved to a remarkable degree throughout a busy and active life. He was thrice married and was the father of eighteen children, Nicholas, father of William, being his youngest child. Nicholas Deckelnick was born in Germany in 1827, grew to maturity in his native land, and became a saddler. He was thirty-three years of age when he came to the United States, and after his arrival in that land established in the harness-making business in New York City, his residence for six years. He then engaged in the same line of business in Scranton, where he was the proprietor of a shop from 1866 to 1890, his

death occurring in the latter year. He married Maggie Wagner and had children: 1. Otto, died in Minnesota in 1910. He was a soldier in the Civil War, being in active service for two years of that time, engaging in many of the important battles of the war, his regiment having an exceedingly active career. From the close of the war until his death he received a pension from the government in recognition of services rendered. 2. William, of whom further. 3. Nicholas, a cigar manufacturer of Trenton, New Jersey. 4. Jacob, deceased. 5. Mattie, deceased. 6. Julius, deceased. 7. Charles, a resident of Scranton. 8. Emma, married a Mr. Hawley, and resides in Trenton, New Jersey.

William Deckelnick, son of Nicholas and Maggie (Wagner) Dickelnick, was born in Prussia, Germany, July 24, 1852, came to the United States with his father in 1860, and attended the public schools of Trenton, New Jersey. He accompanied his father to Scranton in 1866 and learned the painter's trade, later establishing as a contracting painter, continuing in this line until 1890. He is a cornet player of talent and for three years of this period was a member of Tellers Band, the first cornet band organized in Scranton. In 1890, Mr. Deckelnick, opened a hotel on Luzerne street and was proprietor thereof for thirteen years, in 1903 letting the contracts for the erection of a modern and completely equipped hotel at No. 346 South Main avenue. This was ready for occupancy the following year and with his greatly improved facilities for the entertainment of guests, Mr. Deckelnick has there since catered to a large and growing patronage, his business a profitable one, and his venture a success. He and his family are adherents of the Roman Catholic faith, and his political party is the Republican, while fraternally he is connected with the Fraternal Order of Eagles.

He married, in 1873, Lena Frustein, and has children: 1. Rose, married a Mr. Lewis, of Scranton, and is the mother of two sons, Percy and Albert. 2. George, proprietor of the Hotel Deckelnick, on Jackson avenue, Scranton. He is a member of the Fraternal Order of Eagles, the Benevolent and Protective Order of Elks and the Improved Order of Red Men. 3. William, deceased. 4. Maggie, deceased. 5. Caroline. 6. Eugene, associated in business with his father, a member of the Fraternal Order of Eagles.

---

#### ROBERT CHARLES WILLS

Irish in ancestry and birth but distinctively American in works and achievements, Robert Charles Wills, during a life of ceaseless activity has created a mark in the business world of Scranton that reflects ample credit upon his judgment and capacity for accomplishment, and as treasurer and manager of the Keystone Brewing Company stands at the head of one of the most considerable houses of its kind in the locality, also being connected in advisory role with numerous other of Scranton's important institutions. He was born in Ireland, son of Henry and Elizabeth (O'Donahue) Wills, his father dying when Robert C. was but two years of age, and his mother died April 26, 1914, in the homeland, where her son had frequently visited her. Henry and Elizabeth (O'Donahue) Wills were the parents of fourteen children.

Robert C. Wills was born May 15, 1858, and as a boy attended the rural schools of Ireland, coming to the United States when a lad of seventeen years. He at once came to Scranton, Pennsylvania, and entered into the tea business for himself and from this beginning was never employed at a stated salary, much preferring to earn less or more, according to his worth, than to be unalterably valued at a certain figure. In 1883 he purchased property at No. 430 Lackawanna avenue, for \$14,000, and conducted a wholesale liquor busi-

ness until 1894, at which time he disposed of the property for \$40,000. At this time he entered upon the venture that has since become a successful one, by purchasing the Keystone Brewery, the plant fronting on Blakely street, extending from Green to Pine streets. In 1894 the business was incorporated under the name of the Keystone Brewing Company, the plant was enlarged and greatly improved and under Mr. Wills efficient management became one of the most prosperous institutions of its kind in Pennsylvania. The original product of the plant was ale, and in 1899 an addition was made to the building providing facilities for the manufacture of lager beer and porter, which has since been continued with great success. From an annual output of about eight thousand barrels of ale the figure has risen to seventy thousand barrels of lager beer, ale and porter, a market for the entire quantity being found in Lackawanna county, the revenue derived from this industry by the United States government amounting to \$70,000 per annum. The plant is admirably appointed for its work, the bins of the plant having a capacity of four carloads of grain, while the fire-proof brew-house has a copper kettle capacity of four hundred barrels. The pay-roll of the company contains about sixty names, the annual salaries amounting to \$100,000. Mr. Wills is treasurer and manager of the company, and in the active direction of the business he is assisted by the following efficient force: Assistant manager and superintendent, F. B. Butler; private secretary, John J. Cannon; brew-master, Jacob Eckstein, a graduate of one of the foremost brewing institutes of the country, having followed his calling in Germany and in Rochester, New York; assistant brew-master, William Fricker, a graduate of a German brewing institute in Germany, and for twelve years connected with the firm which is his present employer; while the sales department is under the care of John E. Coyne and Edward McDade.

Mr. Wills is otherwise prominently connected with business interests in Scranton as a member of the board of directors of the Scranton Trust Company, the Dime Deposit and Discount Bank, the Fidelity Bank, of Dunmore, the Blue Creek Coal and Land Company, and the Kanawa Railroad Company (West Virginia); president of R. C. Wills Company, of Scranton, wholesale liquor dealers; and a member of the Keystone Realty Company, of Dunmore, Pennsylvania. He is a Democrat in political conviction. He is a member of the Benevolent and Protective Order of Elks, and belongs to St. Peter's Roman Catholic Church, a member of the Scranton Board of Trade, Scranton Club, Scranton Press Club and Young Men's Catholic Club.

Mr. Wills married Anna E. Coroner, a native of Scranton. Mrs. Wills was for several years prior to her marriage a teacher in the Scranton schools. Children of Robert Charles and Anna (Coroner) Wills: Joseph J.; Henry, deceased; Robert, deceased. Joseph J. is now connected in business with his father. Mrs. Wills is one of a family of fourteen children of Patrick and Bridget Coroner, who were residents of Scranton for over fifty years. The palatial family home is at No. 531 Clay avenue, Scranton, located in the finest residential block in the city.

---

#### PATRICK FRANCIS CUSICK

The paternal progenitor of Patrick J. Cusick was Owen Cusick, the well remembered undertaker of Scranton, whose life was a record of kindly deeds and successful business endeavor. The grandfather Cusick came from Ireland in 1854 with his family, settled in Scranton, entered the employ of the Lackawanna Iron and Coal Company, and became store manager. He left children: Bartholomew, Patrick, Michael, Owen, Bridget, married Patrick Judge; Margaret, married Senator J. C. Vaughn.

Owen Cusick, born December 24, 1850, was brought from Ireland by his parents when four years of age. He attended Scranton schools and began business life as a section contractor on the Delaware, Lackawanna & Western Railroad. He was thrifty, industrious and ambitious, determined to rise from that position. He purchased a mule and wagon, beginning in this small way, and later he had one hundred horses, this fact demonstrating the extent to which his business expanded. He gradually built up a livery business, then opened an undertaking establishment, prospering in both branches to an extraordinary degree. At first his location was in Bellevue, but later he moved to a more central part of the city, occupying the old skating rink at the corner of Adams and Mulberry streets. During a severe snow storm and blizzard in 1888 the building was blown down, then caught fire and was totally destroyed, entailing a severe loss upon Mr. Cusick, the property being uninsured. He purchased a fine property on Court House Square which is yet owned by his heirs and there continued the undertaking business until his death. During his life as undertaker Mr. Cusick won a place among genuine philanthropists by his warm hearted generosity to the poor. He never refused to bury their dead even when there was not the faintest chance of his being paid, nor did he ever render an unsolicited bill. As the Good Book says, "there is he that scattereth yet increaseth," so it was with Mr. Cusick, his charity not hindering but seemingly aiding him on the road to success. He is most kindly remembered, for he left behind him a record of a well spent, useful life. During his active years he was much interested in public affairs, and at one time was elected clerk of the Court House by a plurality of ninety-eight votes. The closeness of the vote induced the incumbent of the office, who was also the defeated candidate, to contest the election. Under the law then in force, now repealed, the incumbent held over until the contest was decided in the courts. By legal process unfathomable to the layman, decision was delayed until the term for which Mr. Cusick was elected had expired, the defeated candidate for the office holding over a full term as if duly elected.

Owen Cusick married Mary, daughter of Michael Spellman, of Archbald, Pennsylvania. Children: Mary, Theresa, John, Patrick F., of whom further; Eugene A., secretary and treasurer of the Cusick Company; Emily, Elizabeth, married James F. Bell; Michael, Ambrose and Bartholomew. Owen Cusick died July 28, 1894.

Patrick Francis Cusick, son of Owen and Mary (Spellman) Cusick, was born in Scranton, Pennsylvania, February 14, 1881. He attended Saint Cecelia's Academy until thirteen years of age, when he succeeded his father in the undertaking business. The business founded by Owen Cusick is still continued under the name "Cusicks," the manager being one of the founder's sons, Eugene A. Cusick. In 1905 Patrick F. Cusick organized the Standard Brewing Company, of which he is secretary, treasurer and general manager; in 1906 the Cusick corporation of which he is president; and the Scranton Distributing Company, of which he is president. These are all successful enterprises, the plant of the Standard having proven too small within a few days after being placed in operation. A second contract was placed at once that doubled its capacity, but this also proving inadequate, a third enlargement was made, the plant now being able to meet all demands made upon it. The company is entirely independent, not being connected with any other plant or trust. In the course of business it became necessary to purchase the business of E. J. Walsh, and this large wholesale business covering five states is conducted under the management of the Scranton Distributing Company, of which Mr. Cusick is president. In 1910 he was elected president of the First National Bank of Jessup, a most prosperous institution. As a successful and

energetic business man Mr. Cusick holds high rank, yet he is most genial and social, belonging to many fraternal and beneficial societies both within and with the church of his choice, Saint Peter's Roman Catholic Cathedral. He is a member of the Benevolent and Protective Order of Elks, Fraternal Order of Eagles, Knights of Saint George, Catholic Knights of America, Knights of Columbus, Saint Peter's Total Abstinence and Benevolent Society, Red Cross, Ancient Order of Hibernians, Young Men's Institute, Young Men's Christian Association, Irish American Society, Friendly Sons of Saint Patrick, Scranton Board of Trade, Manufacturers' Club of Philadelphia and the Pennsylvania Society of New York. In politics he is strictly independent. Although a young man, Mr. Cusick began business life at so early an age that he is a veteran in all but years. His career has been marked by a succession of successful enterprises, and in their management he displays the highest order of executive ability. His residence is the well known property, the Carlucci Mansion at No. 1048 Clay avenue, which he purchased in 1913.

---

#### MICHAEL BOSAK

Progress in business life and the success awarded progress has been the portion of Michael Bosak, achieved in a country to whose manners, customs and tongues he was a stranger. His advance has been due to his readiness to seize opportunity and his willingness to work, two qualities comprising an infallible formula for success.

A descendant of a Hungarian family of great antiquity, he was born in Okonble, Saros, Austria-Hungary, December 10, 1870, son of Michael and Anna (Tokarsky) Bosak. His father is a farmer, and at the present time he and his wife live on the home farm in their native country, never having left that land. Michael Bosak attended the public schools in the town of his birth, and until he was eighteen years of age was his father's assistant on the farm, coming to the United States in 1888 and obtaining employment in a breaker at the coal mines at Hazleton. After several years of mine service he secured a position as clerk in a general store at Freeland. His natural habits of thrift had enabled him to save quite a large sum of money, at least, large in comparison with the amounts he had formerly possessed, and after three years' employment as clerk he established a store under his own name. A year later, in 1893, he moved to Olyphant and engaged in the liquor business, of which his present banking business and steamship agency is an outgrowth. In 1907 his business at Olyphant had assumed such gigantic proportions that he opened a branch house at Scranton, whose growth and expansion has been so rapid that in size and the amount of business transacted it quite eclipses the parent institution and is regarded as the principal interest. The site of the business is at No. 434 Lackawanna avenue, the building having been remodeled at a cost of \$45,000, when the Scranton branch was established. Three stories and a basement are required to properly house the business, which employs twelve persons. The house is the accredited representative of all the transatlantic lines as well as of numerous lines plying a coastwise course. For the accommodation of the large number of foreigners to whom the bank caters, clerks having a knowledge of all the European languages are employed, a point which is a great attraction to newly arrived immigrants, who are so often made the dupe of thieving confidence men. Mr. Bosak is also the proprietor of a wholesale liquor store. His other business relations are as director of the County Savings Bank and of the Scranton Guaranty and Surety Company; vice-president of the First National Bank, of Olyphant, of which

he was an organizer; and president of the Slavonic Deposit Bank of Wilkes-Barre for which he performed the same office, that of organizer. A Democrat in politics, he has served one term as member of the Olyphant council and was the defeated candidate of his party for the office of clerk in court in Olyphant.

Mr. Bosak married Susanna, daughter of John Hudak, a native of Austria-Hungary; children: Mary, married Julius Stroneczer; Michael, the fifth generation of the family bearing that name; Josephine; Francis.

---

#### HENRY KEHRLI

This record deals with three succeeding generations of the Swiss family of Kehrlí, all of whom came to the United States, the first for a quarter of a century a resident of this country, the second returning to his native land after a sojourn here of one year and a half duration, the third the present representative of his line in the city of Scranton, Henry Kehrlí.

(I) His grandfather, Andrew Kehrlí, was born in Switzerland and immigrated to the United States, settling at Highland, Ohio, for twenty-five years pursuing his occupation, that of farmer. He married and was the father of four children: 1. Caspar, of whom further. 2. Catherine, married and lives in Switzerland. 3. Annie, married and lives in Switzerland. 4. Marguerite, deceased.

(II) Caspar Kehrlí, son of Andrew Kehrlí, was born in Switzerland in 1830, died in 1909. His occupation was two-fold, wood-carving and farming, and these he followed all of his active years. He at one time came to the United States, his trip in the nature of a visit, returning to his native land after one year and a half. He married Barbara Naegeli. Children: 1. Catherine, married Godfried Anliker, a teacher of Switzerland; twelve children. 2. Andrew, married Eleanora, daughter of John Bladder; resides in Factoryville, Pennsylvania; seven children. 3. Caspar, married Catherine Naegeli; two children. 4. Barbara, married Caspar Naegeli; one daughter. 5. Henry, of whom further. 6. John, deceased. 7. Fred, married Kate Fuher; five children. 8. Arnold, married Margaret Roth; one child. 9. Annie, married Michael Abplanalp.

(III) Henry Kehrlí, son of Caspar and Barbara (Naegeli) Kehrlí, was born in Bern Canton, Switzerland, October 13, 1868, and there attended the public schools until he was fifteen years of age. He was for a time employed on his father's farm, also performing fine wood-carving, and when twenty years of age immigrated to the United States, sailing on the French liner "Labradori," and landing in New York City, April 1, 1888. While acquainting himself with the language and customs of the new land to which he had come he obtained work as a laborer, in 1890 obtaining a position in a butcher shop, and, learning the trade, was so employed for six years. At the expiration of this time he established in independent business at No. 1372 Washington avenue, Scranton, eight years later moving to his finely appointed shop at Nos. 1401-03-05-07 Washington avenue, his residence adjoining his place of business. The lucrative trade that he built up in his old location followed him to the new, and there he continues to the present time, the proprietor of a strong and vigorous business, extensively patronized, deriving its strength and vigor from the principles of honor and fair-dealing upon which it has ever been run.

Mr. Kehrlí married, in 1895, Annie, daughter of Caspar and Margaret Naegeli, natives of Switzerland, now residents of Scranton, Pennsylvania. Children: Adeline, a student in high school; Lillian, a student in the technical high school; Andrew, Esther, Ruth, Anna, Henry, Florence. Affiliating with

the Lutheran church, Mr. Kehrli is a member of Schiller Lodge, Free and Accepted Masons, and the Scranton Swiss Benevolent Society, and is a supporter of the Republican party.

---

### BENJAMIN GARFIELD EYNON

Holding place in the public service as chief clerk to the Lackawanna County Commissioners, Benjamin G. Eynon has not only been related to the interests of the Scranton region in a political capacity, but has also been connected with several of its financial and manufacturing institutions, as well as with the construction department of the Delaware, Lackawanna & Western Railroad Company. At the present time he is the capable treasurer of the Standard Clay Company, of Scranton, and chief clerk to the Lackawanna County Commissioners.

(I) His ancestry is Welsh, his grandfather, Thomas Eynon, having been born in Wales, coming to the United States in young manhood. He married a Miss Leyshon, and had children: 1. Albert B., of whom further. 2. George F., a retail grocer of Scranton; married Kate Cramer, and has children: Charles A., Thomas F., Jennie, married a Mr. McGarrah. 3. Jennie, married Dr. Beddoe, of Scranton.

(II) Albert B. Eynon, son of Thomas Eynon, was born in Carbondale, Pennsylvania, in 1837, and at the present time is cashier of the West Side Bank of Scranton. He married Anna Barnes, daughter of Benjamin Hughes, her father for many years general superintendent of the coal department of the Delaware, Lackawanna & Western Railroad Company. Albert B. and Anna Barnes (Hughes) Eynon are the parents of: 1. Thomas A., a graduate, D. D. S., of the University of Pennsylvania; married May, daughter of Thomas Thomas. 2. Benjamin Garfield, of whom further. 3. Howard B., a graduate of the chemical engineering course of the University of Pennsylvania, being honor student of his class, at the present time assistant chemist of the American Carbon and Lamp Company, of St. Louis. He married Maude Eames, and has one son, Blaine Eames. 4. Paul J., educated in the Scranton public schools and the Keystone Academy; a bookkeeper in the West Side Bank.

(III) Benjamin Garfield Eynon, son of Albert B. and Anna Barnes (Hughes) Eynon, was born in Scranton, Pennsylvania, October 6, 1881, and was educated in the public schools of his native city, graduating from the high school in the class of 1901. His first business experience was obtained in the West Side Bank, after which he was employed as bookkeeper by the Scranton Woolen Mills. His next service was in the bridge and building department of the Delaware, Lackawanna & Western Railroad Company, in which employ he was in charge of all of the accounts of the department relating to work west of Portland, Pennsylvania. In 1912 Mr. Eynon was appointed chief clerk of the county commission, and holds this position at the present time, his work in this capacity having been of so complete, thorough and exact a nature as to win the hearty approval of his superiors in office. His business interests at this time are confined to the Standard Clay Company, of which he is secretary and treasurer. This concern owns land at Little Gap, Monroe county, Pennsylvania, and from pits on this property is shipped a fine grade of white silica sand used in the manufacture of glass and fine chinaware, the business conducted by the company being large and lucrative. Mr. Eynon's political party is the Republican, and he is a member of the Plymouth Congregational Church. He fraternizes with Hyde Park Lodge, No. 339, F. and A. M.; Lackawanna Council, No. 1133, R. A.; and Heralds of Liberty.







*Chas. H. Creswell*

Mr. Eynon married, June 14, 1904, Ida Lucretia, daughter of J. W. Moore. Her father was a native of Wales and after coming to the United States made his home in Ohio, in which state he married Elizabeth Williams, and had children: Cordelia; Charles W., of Scranton; Arthur J., a dentist of Dickson City, Pennsylvania; Nellie, married Isaac Scull, of Newark, New Jersey; Ida Lucretia, of previous mention, married Benjamin G. Eynon. Mr. and Mrs. Eynon have one daughter, Pauline Moore, born May 28, 1907.

#### CHARLES HERBERT CRESSWELL

Charles Herbert Cresswell is a Scranton representative of a family whose history has been long connected with England, that being the country of his birth. The following record, brief as it is, will show its members to be and to have been citizens whose walks in life have made of them useful men, men of deed and achievement worth while, and patriots every one. Charles H. Cresswell, of Scranton, is a grandson of Charles Cresswell, an English manufacturer of boxes. He married and was the father of: Herbert, of whom further; Mary, married Charles Oakford; Helen, unmarried; Sarah Ann, married Thomas Warsop and has one son, Thomas Jr.; Arthur, a cattle dealer.

Herbert Cresswell, father of Charles Herbert Cresswell, was born at Nottingham, Nottinghamshire, England, September 15, 1849. His active business life has been passed as a merchant in his native land. He married Caroline Watson, of Lincolnshire, England. Their children: 1. Clara, married Henry Black; resides in Johannesburg, South Africa. 2. Charles Herbert, of whom further. 3. Arthur, married Florence Loseley and lives in New Zealand; four children: Maud, Lillian, Kathleen, Herbert. 4. Ernest, engaged in business with his father in Nottingham, England; married Emma Trollop; one daughter, Hilda; he served under General Buller in the Boer War, being attached to the signal corps. 5. Richard, a soldier of the famous "Scots Greys" in the Boer War; in one of the battles of that war the major of his regiment was shot from his saddle while leading his troops and as he fell was caught by Mr. Cresswell, who carried him from the fight to a place of comparative safety, for which gallant act he received a medal of high distinction from his government. 6. William, a lace curtain manufacturer of Nottingham, England; married Mabel Wilson. 7. Mabel, married Thomas Parr and has children: Norman and Kenneth. 8. Harris, emigrated to Scotland, 1904; married Emily Hobbs, one child, Joseph. 9. Albert Edward, an electrical engineer of Liverpool, England, married Jessie McKenzie.

Charles Herbert Cresswell was born in Nottingham, Nottinghamshire, England, November 16, 1870. He was there educated in the public schools, completing his studies by a course in Bridgeford College, which he attended from 1884 until 1887. He served a five years' apprenticeship with Simon May & Company, of Nottingham, in the lace trade, at the end of that time taking passage on the steamer "Teutonic," landing in New York City, January 17, 1892. One of his uncles being a resident of the city of Scranton he made his way hither, on July 1 of the year that he reached this country, entering the employ of the Scranton Lace Curtain Company, with which concern he has since associated. His first capacity was shipping clerk, and he prepared for shipment the first consignment of goods to leave the plant of the company. Mr. Cresswell has since then held numerous positions in the company's service, and is now superintendent of the finishing department, the operations in his department being the last received by the products of the plant before their shipment to the consumer. The fact of his twenty-four years' acquaintance with the processes and methods of the plant are not the only factors in his

value to his employers, his careful and accurate supervision of the work of his department rendering highly improbable work that might lower the high standard now realized by the Scranton Lace Curtain Company. His application to his work is intense and absorbed, all of his energies devoted to the task of best serving his employers of so many years, and the trust and confidence reposed in him is full evidence that he has not fallen short of this goal. He is an Independent in politics; he is a member of Peter Williamson Lodge, No. 323, F. and A. M., member of the Church of the Good Shepherd (Protestant Episcopal).

Mr. Cresswell married Marie Jane, daughter of Jesse Shepherd; children: Nellie, born August 20, 1899, a student in the Scranton High School; Herbert, February 14, 1904; Mabel Caroline, October 23, 1906; Charles Edward, July 20, 1907; Ernest Jesse, December 29, 1909.

#### ABRAHAM L. SCHILLER

A native of Russia, Abraham L. Schiller has been a resident of the United States since he was twenty years of age, and since making his home in Scranton has achieved business success and prosperity. His advancement from the estate of the poor immigrant to the man of affairs and influence, prominent in fraternal and religious circles, provides a story of interest.

(I) Russia has long been the family home, Abraham L. Schiller descending from ancestors who have been noted exponents of the Jewish law and faith, his great-grandfather, Kalmenson Altschiller, a Talmudist; his grandfather, Leib Altschiller, and his father, Aaron Altschiller, having both been Rabbis. The name in Russia was Kalmen when only one name was given, afterwards Kalmenson, that is a son of Kalmen, and when a second name was adopted it was Altschiller from living in the old Synagogue. Abraham L. Schiller dropped the "Alt." Kalmenson Altschiller passed his entire life in service among the poor of the city of Chavues, giving of his goods and seeking aid from his friends for the betterment of the pitiable plight of those in want and distress.

(II) Leib Altschiller married a daughter of Moses Reichenstein, the inventor of the one thousand year calendar. Moses Reichenstein has prospered from his ingenious device and now resides in New York. Leib Altschiller was the father of: Aaron, of whom further; Klemen; Judah, a resident of Joffa, Palestine, aged seventy years; Esther, married Hezekiah Jason, and has eighteen children, all of whom survive to the present time.

(III) Aaron Altschiller, son of Leib Altschiller, died in Russia, his lifelong home, in 1907. He was a rabbi and was the author of numerous works on religious subjects that found wide reading and high favor. He was a cousin of the Moses Reichenstein previously mentioned. Aaron Altschiller married Mary Terman, who is now living, aged eighty-seven years, and had children: Rebecca, married Samuel Patz, and has children: Fannie, Rosa, Dora, Bessie, all residents of Scranton; Rachel, married Samuel Polkobe and has children: Sarah, Belle, Wolf, Lester, Louis, Aaron, Joseph; Leon, unmarried, lives in Russia; Abraham L., of whom further; Sara, married Israel Hine, eight children, all living in Scranton.

(IV) Abraham L. Schiller, son of Aaron and Mary (Terman) Altschiller, was born in Russia, September 22, 1872, and lived in his native land until he was twenty years of age, there being educated and learning the business of watch-making. Upon his arrival in the United States he met many discouragements and embarrassments owing to his ignorance of conditions and his lack of friends to direct and advise him, but he finally found employ-

ment in a hat factory at Orange, New Jersey. Here he remained for three months, then became associated with Mr. Fred, a watch-maker of Newark, New Jersey, continuing in his employ for four months. Moving to Avoca, Pennsylvania, he purchased an established jewelry business in that place, and after conducting it for one year made advantageous disposal thereof and came to Scranton. He at once entered the jewelry business and subsequently became employed, in 1898, by Charles Aaronson, a jeweler of No. 111 Penn. avenue, being admitted to partnership by Mr. Aaronson a year later. In 1903 he bought the interest of his partner and former employer and has since conducted the business under his own name, having incorporated it as the A. L. Schiller Loan Company, of which he is president.

Mr. Schiller is a member of the Israel Lodge, Independent Order of Odd Fellows; the Modern Woodmen of America; the Young Men's Hebrew Association, and the Independent Order Brith Abraham, of which he is vice-president. He is chairman of the Federation of American Zionists, a director of the National Immigration Society of the United States and Canada, president of the United Hebrew Charities, ex-president of the Monteferris Hebrew Free Schools, and vice-president of the Linden Street Hebrew Temple. His political party is the Republican. He married Lena Lasevitz, born in Russia, and has children: Milton, Samuel, Louis, Joseph, Arthur, Mildred, Rebecca, Dorothy.

---

#### NATHAN BERNARD LEVY

The career of Nathan B. Levy contains a story of a life-long ambition realized and a goal attained through unswerving constancy to a youthful ideal. He is a native of Russia, Neuschtadt having been the city of his birth, in which place his father was a merchant, a descendant, through Asher Levy, of the great Jewish merchant, Gabriel Memler. His father married Hannah Blumenthal, daughter of Lob and Ida (Abelson) Blumenthal, her father a scholar and an authority on the Talmud, a descendant of the great Rabbi Shabthay Cohen, one of the best known characters in Jewish history. Ida was a daughter of Isaac Abelson, one of the wealthiest merchants of Leipsic, Germany, his residence being in the city of Neuschtadt, which at that time belonged to Prussia. About 1805 the Prussian government offered, as an inducement to progress and the introduction of modern institutions, a prize for the erection of the first brick building in the city, the trophy being won by Isaac Abelson, the building reared by his order standing to the present day. The father of Nathan B. Levy was also a merchant of Neuschtadt, conforming to the Jewish religion, and was president of the Neuschtadt Temple, being a man of importance and influence in the community and superintendent of the volunteer fire department.

Nathan Bernard Levy was born March 15, 1860. He attended school until he was fifteen years of age, when he left his home to journey to Birmingham, England, at that time the jewelry center of the world, for training in the jewelry business. After three years in that place, giving his entire time to learning this business, he immigrated to the United States, and was further taught and instructed in the establishment of L. Levy, an elder brother, four years later venturing into independent dealings in Scranton. In 1884, two years after the inception of this undertaking, he formed a partnership with Kalman Levy, a younger brother, an association which has since been continued and has thoroughly and carefully developed a jewelry business of such dimensions that it is recognized as one of the largest of Eastern Pennsylvania. Representatives of the house cover a wide territory, and the able

methods of the concern, backed by the quality and reliability of its goods, secure a generous proportion of business in a field where competition is rife. Mr. Levy is a member of Schiller Lodge, Keystone Consistory, Irem Temple, Nobles of the Mystic Shrine, and fraternizes with the Benevolent and Protective Order of Elks. His club is the Excelsior and he worships in the Madison Avenue Temple.

---

### JACOB MORRIS FRANK

Born in far-away Russia, Mr. Frank sought his fortune in the Western world when a young man of nineteen years, reaching the United States during the year all patriotic Americans were celebrating the one hundredth anniversary of the Declaration of Independence, a most fitting time for the son of the most absolute monarchy to begin life in the greatest republic.

Jacob M. Frank was born in Russia, August 5, 1857, son of Louis and Sarah Frank, the former a grocer and real estate dealer. He was the second child and only son of his parents; he had sisters Rachel and Ida, the former deceased. Jacob M. was well educated in the Russian schools, passing through the higher institutions open to him and acquiring a good knowledge of language and literature, both Russian and Jewish. In 1876 he left the land of his birth, and after a long voyage on a sailing vessel reached the United States. He located in Scranton and for several years was engaged in peddling. He then purchased a grocery store which he successfully conducted until 1913, when he sold out and invested his capital in Scranton real estate, devoting himself now entirely to its management. He is a member of Keneneth Israel Congregation, Linden Street Synagogue (Orthodox), and to the Jewish societies, Brith Abraham and Independent Western Star of Chicago. In political faith he is a Republican.

Mr. Frank married Ida Cohen, born in Russia, daughter of Isaac Cohen, who came to Pennsylvania, settling in Scranton; she died April 13, 1914, aged fifty-nine years. Children: 1. Hyman B., born in August, 1877; he was a foreman for the Delaware & Hudson Railroad for seven years, now an employee of the city of Scranton; he married Stella Seigel and has children: Samuel, Rose, Sarah. 2. Nettie, born in September, 1880; married Joseph Kurlancheek, of Carbondale, and has children: Loui, Fanny, Freda, Francis, Hannah, Goldie, Reva, Bernan. 3. Harris, born in November, 1886; married Lella Schapiro and has children: Irving, Marian, Myron. 4. Samuel J., born August 7, 1889. 5. Leona, born November 30, 1893; graduate of Scranton public schools and Lackawanna Business College; was a cashier of the Boston Shoe Market.

---

### ISADOR FINKELSTEIN

In 1890, Isador Finkelstein, a young Hebrew of seventeen years, landed from the steamship, "Etruria," in New York City with little besides his stout heart and ambition to start him on his career in a strange land, where even the language was unfamiliar. To-day a successful wholesale merchant of Scranton, he reviews his course upward with pleasure and pride, even finding material for amusement in some of the earlier experiences. This upward path has not been one of easy grades, but each step of the earlier journey was taken under circumstances and against odds that would have discouraged a less stout hearted man, but the crest was finally reached and now from a secure height he reviews a life well spent and far from ended. He is a son of Bernard Finkelstein and grandson of Jacob Finkelstein, both of Russian

birth, the former now a resident of Scranton, although many of his years were spent in his native land. Bernard Finkelstein married in Russia, Sarah Genburg, and has children: Aaron, Jacob and Isador, all now residing in Scranton.

Isador Finkelstein was born in Russia, August 1, 1873. He obtained a good education in a Hebrew College, his diligence and ambition gaining him honorable distinction among his college mates. In the year 1890 he left his native land, journeyed across Europe to the coast and taking passage on the steamship "Etruria" arrived in due season in New York City. Here he was employed for one year with the tobacco firm, Paul Brothers, learning cigar making and gaining a knowledge of tobacco that later he turned to good account. At the end of the year he came to Scranton and after several attempts to obtain suitable employment decided to have a business of his own. He began with a lunch wagon and so well did he succeed that he commanded in a short time sufficient capital and credit to engage in the tobacco business. He was ambitious to an unusual degree and despite his small capital decided to conduct an exclusive wholesale business in both cigars and tobacco. He started in a small way, but he knew his business, worked faithfully, bought and sold judiciously, gradually expanding until to-day he transacts a business amounting annually to hundreds of thousand dollars, the firm operating as the Imperial Cigar Company, Goldberg and Finkelstein, proprietors. Still a young man in years, Mr. Finkelstein is ambitious of still greater expansion and with the record of his past twenty years as a guide, the heights to which he will rise in the business world are surely far above his present altitude. He has won through merit and courage, good business methods and an adherence to his one specialty, cigars and tobacco, and his one way of selling. The lesson taught by the business life of this successful man should not be lost, so clearly does it prove the value of concentrating all one's efforts on a special line and thoroughly mastering all its detail. Energy, perseverance and courage cannot win one's fight alone, but these qualities must be well directed and confined within clearly defined limits.

Mr. Finkelstein is a member of all bodies of Keystone Consistory, Ancient Accepted Scottish Rite, thirty-second degree; Schiller Lodge, No. 345, 4<sup>th</sup>, and A. M.; Irem Temple, Ancient Arabic Order Nobles of the Mystic Shrine; the Benevolent and Protective Order of Elks; the Young Men's Hebrew Association. In political faith he is a Republican. He adheres to the Orthodox faith of his fathers, worshipping with congregation of Linden Street Synagogue.

He married Yetta, daughter of Hyman Harvey, of New Britain, Connecticut, and has children: Abraham, born June 19, 1898; Harold, May 15, 1900; Ruth, January 15, 1905; Miriam, April 5, 1909.

---

### JOSEPH H. NOLAN

To Joseph H. Nolan there belongs the credit that is always due one who has the courage and the initiative to enter into any enterprise to which he is unaccustomed, be it commercial or otherwise. With absolutely no experience in the laundry business, he and two partners established in such an undertaking fifteen years ago. For the past seven years Mr. Nolan has been the sole proprietor and has built up a large business, giving employment to about ninety persons.

Westmeath, Ireland, was the place claimed by James Nolan, father of Joseph H. Nolan, as his birthplace and it was from there that he came to the United States when but a boy, making his home in different parts of New

England. He learned the trade of machinist and later surveying, being especially well adapted for the latter occupation because of his liking and aptitude for mathematics. Quickness of perception, a racial characteristic, combined with the thorough training he received under the able workman with whom he learned his trade, made him a master machinist. He was employed on the Federal ironclad, "Monitor," when it was in course of construction at Greenpoint, Long Island, under the direction of John Ericsson. The "Monitor" is best remembered by her conflict with the "Merrimac" in Hampton Roads, the first battle ever fought between two vessels of metal construction. After working for a time in New York, Mr. Nolan came to Scranton, where he accepted a supervisory position in the shops of the Dickson Manufacturing Company, resigning to go to Oxford Furnace, New Jersey, to erect shops for the accommodation of the Scranton interests. About 1873 he returned to Scranton and was engaged as draughtsman by the Delaware, Lackawanna & Western Railroad, remaining in that employ until his retirement a few years before his death. He was a capable workman and a courteous, well-liked gentleman. He married Ruth, daughter of Henry Jepson, a descendant of the old New England family of the name that played such a prominent part in the Revolutionary War. Children: Mary, married William Kelly, and resides in Scranton; Anna, married Dr. Fitzsimmons, of Scranton; Joseph H., of whom further.

Joseph H. Nolan was born in Oxford Furnace, New Jersey, April 8, 1867. He obtained his education by attendance at the public schools, and when fourteen years of age entered the employ of Leonard Brothers, in the hardware store. Outside of his connection with the business of which he is now proprietor, this has been his only position in the service of others. He remained in the store for twelve years, leaving in 1898, when he, in partnership with two others, Messrs. Gallagher and Manley, established the Crystal Laundry. Their start was an unpretentious one, two wagons being used for collection and delivery work, and ten or fifteen persons being employed in the laundry. In 1906 Mr. Nolan became the sole owner of the business, now a flourishing concern, employing about ninety persons and keeping ten wagons in constant use. The laundry is a favorite one with the townspeople and those living in the outlying territory, its popularity being a just reward for the labors of Mr. Nolan, whose efforts to bring it to its present efficient condition have been so unceasing.

Mr. Nolan married Elizabeth, daughter of Matthew Snow, of Scranton, and has two children, Joseph and Marion. Energetic and ambitious, the success of his undertaking is directly attributable to Mr. Nolan. Full of the fiery vigor of youth, one achievement brings with it the desire for another, and other triumphs should await him in the days to come.

---

#### FREDERICK G. WALDNER

Two and a half decades cover the period during which Frederick G. Waldner has been connected with the business life of the city of Scranton, he being the only one of his line to find his life work in that place. His father, Gottlieb Waldner, was born in Germany, January 5, 1840, and there learned the gardener's trade in which he became a skilled and artistic workman, coming to the United States in manhood. In Philadelphia he found a field offering infinitely greater possibility in his line, inasmuch as gardening was not a business for which necessary training and teaching could be obtained on this side of the ocean, more necessary occupations than that of adornment claiming the time and attention of workmen in the United States. He lived in



that city until his death. His wife was Barbara (Miller) Waldner, and they were the parents of: Frederick G., of whom further; Charles, Arnold, Paul, Richard.

Frederick G. Waldner, son of Gottlieb and Barbara (Miller) Waldner, was born in Switzerland, March 15, 1867. He was there educated in the public schools, later coming to Philadelphia, Pennsylvania, landing in that city, October 9, 1881. He was there employed until November 22, 1890, on which date he moved to Scranton, establishing a bakery. To this he has added ice cream dealing and catering, and at the present time conducts a well patronized business at No. 634 Washington avenue. In the fulfillment of catering contracts he has an advantage over competitors in that several of his articles most in demand are made under his personal supervision, and his capable business methods have made a desirable impression upon those dealing with him. Mr. Waldner is a thirty-second degree Mason, and belongs to the Liederkrantz and the Junger Mannerchor. He married Lena Robling, and they are the parents of: Paul, born April 22, 1893; Lucelia, born July 18, 1895, died June 6, 1913.

---

#### GEORGE F. VASEY

First to Canada and then to the United States is the American record of this line of the family of Vasey, founded in the province of Ontario, Canada, by John Vasey, of Ireland, who came to that locality with his family. His trade was that of blacksmith, a calling he followed in connection with contracting on the Welland Canal, then in course of construction. He married and had children: John, deceased, married Charlotte Adams, and was the father of Hugh, John, Margaret, Nora, William, Joseph, James, Sarah, George, Mary; Hugh, deceased, married and had children, resided in St. Louis, Missouri; William, of whom further; James, deceased, married and had children: Barrett, William, Nora; George, deceased; Mary, deceased.

(II) William Vasey, son of John Vasey, was born at Campbell Quarry, Ontario, Canada, December 26, 1837. In his youth he worked with his father, who was then engaged in contracting, and who later purchased a farm, which he cultivated for many years. Later William Vasey purchased a farm and spent some years on it and later another farm where he spent his last years and where his son John still resides. He married Mary Jane, daughter of William Lister, of Ontario. William Lister was a son of William Lister, of the firm of Lister & Sons, foundry proprietors of Darlington, England. William Lister was the father of William, Thomas, John, and Mary Jane, of previous mention, married William Vasey. Children of William and Mary Jane (Lister) Vasey: George F., of whom further; Nora; Mary; John, married Johanna Kenney, and is the father of William and Mary; James, deceased; Eliza; Ellen; May; William; Gertrude; Vincent.

(III) George F. Vasey, son of William and Mary Jane (Lister) Vasey, was born in Durnoch, Grey county, Ontario, Canada, February 4, 1876. As a boy he attended the Separate Schools of Ontario, then worked on a farm until he was eighteen years of age. On November 4, 1898, he entered the employ of the Lake Superior Corporation, in the paper mills, lumber woods, and mines, becoming superintendent of exploration and development work, of the Sultana Strathcona and other mines. He was so employed until September, 1903. Resigning then from this position, Mr. Vasey moved to Scranton, entering the employ of Sprague & Henwood, remaining with this concern until 1905. In the spring of the following year he went to Duluth, Minnesota, taking charge of the work conducted by the L. G. Bradley Exploration Com-

pany in the Mesaba Iron Mines, on January 1, 1907, returning to Scranton. Here he accepted a position as the eastern representative of Jacques, Baszanger & Company, of New York and Paris, importers of rough diamonds, carbon, and bortz, and manufacturers of diamond tools, and is so employed at the present time. During the course of his professional career, Mr. Vasey has become identified with the Canadian Mining Institute, and the Engineering Society of Northeastern Pennsylvania, and is also a member of the Scranton Board of Trade, the Catholic Club, and the Knights of Columbus, his church being St. Paul's Roman Catholic.

Mr. Vasey married Elizabeth Bower, daughter of Nicholas Bower, of New York state, a descendant of a German family.

---

#### HENRY T. KOEHLER

In giving an estimate of the character of Henry T. Koehler, of Scranton, Pennsylvania, we find a happy combination of the best characteristics of his German forbears with the more progressive methods to be found in this country. He was born at Erie, Pennsylvania, December 18, 1861, son of Henry and Christine Koehler, both deceased, the former named a native of Germany, the latter named a native of York, Pennsylvania.

He received a plain but substantial education in the private school taught by his father, attending the same up to thirteen years of age, when he obtained a position with Garney, Short & Company, leading tobacconists, as clerk, where his conscientious discharge of the duties which fell to his share was not unobserved, and he was advanced from one responsible position to another during the seventeen years he remained in the employ of this firm. During his leisure time he found opportunities for the display of his natural abilities as an organizer, and it is due to him that numerous clubs and organizations were called into existence. His popularity is attested by the fact of his being called to public office, and he has served as county auditor, and then as register of wills. Later he held the position of clerk of the orphans' court, which position he still holds. His management of this department was a masterly piece of work, and proved conclusively that the confidence which had been reposed in him had not been misplaced. He ever has the best interests of the city at heart, and is doing his utmost to improve and beautify it. It is mainly owing to his strenuous personal efforts that the three fine statues of Columbus, Washington and Sheridan now adorn the city at Court House Square, he being the leading spirit of the small company of patriotic men who worked together for this end, and he was at one time president of the association which took this matter in hand.

Mr. Koehler is a member of Schiller Lodge, No. 345, F. and A. M.; Keystone Consistory, Ancient Accepted Scottish Rite; Irem Temple, Nobles of the Mystic Shrine; the Northern Jurisdiction of the Supreme Council, thirty-third degree; and Washington Camp, No. 242, P. O. S. of A., United States of America. He has served the state as vice-president of the last mentioned association, and assisted in organizing almost all the camps instituted in Northeastern Pennsylvania. He was twice elected president of the local Camp, and during the State Camp held in 1888 served as chairman of the reception committee. He has also served as treasurer of the Funeral Benefit Association for the past twelve years. His thorough knowledge of parliamentary laws and customs is universally conceded to be remarkable, and he takes high rank as a debater. He is a quiet, but forceful speaker, his words being well chosen, come readily to his lips, and his facts marshalled in orderly array. He is of a simple, unaffected nature, a firm friend, and helpful in



*Henry T. Koehler.*



works of a charitable nature. Mr. Koehler married, December 8, 1904, Clara R. Hughes.

---

### THOMAS H. McLOUGHLIN

James and Julia McLoughlin were pioneer settlers of Scranton, where he was one of the first to build a residence on what is now called Hyde Park, in the year 1854. James McLoughlin was of Irish descent and born in Dublin. Julia McLoughlin was born on the ocean, and was a daughter of John and Mary Durning; the mother of Mary Durning was born in county Sligo, Ireland, of Irish parents by the name of Cox, all honest citizens of the home country, none of whom emigrated but Mary. Mary Durning lived to the ripe old age of eighty-five years; she was the only sister of eleven brothers, all of whom followed the trade of shoemaking. John Durning, the father, lived to the age of seventy years.

James McLoughlin was a journeyman brewer of beer by occupation, and he and his wife, Julia (Durning) McLoughlin, made but one move in life, that from his father's home in Tobyhanna, Pennsylvania, to their own home in Hyde Park, Scranton. Children: Patrick, Mary, Mary Jane, all born in Scranton, and now deceased; the living are: John J., single; James, single; Emma; these were all born in Scranton also. Mary at the time of her death was forty-six years of age, and had married Bernard F. Began, of Rhode Island, born of Irish parentage, now deceased. This union was blessed with seven children, of whom six are living: Bernard F., died in infancy; Mary, married Patrick Connors; Emma, married Claude Westley; Veronica, married Leroy Kettle; John, married Mary J. Roland; Bernard F.; James F. Emma McLoughlin married John W. Brown, of German parents; they had but one child, a daughter, Lillian E., who is now married to Charles H. Beggs, of Daleville, Pennsylvania, and is a convert to the Catholic church. Mr. and Mrs. Beggs have two sons, William J. and Henry Columbus.

In the year 1867 the home was saddened by the death of the husband and father, James McLoughlin, leaving a widow and six children. Mr. McLoughlin had served all through the Civil War. In 1871 Mrs. Julia (Durning) McLoughlin married (second) Michael J. Clancy, born in Tipperary, Ireland. Children: Ellen, now deceased; Peter F., engaged in his early days as a shoe merchant in Scranton, later went to California, where he is proprietor of a ranch and alfalfa farm, married a Miss Browning at Woodland, California, of an old California family; they had two children: Thomas H., living, and a child deceased; Thomas H., of whom further.

Thomas H. (Clancy) McLoughlin is a graduate of the Scranton Business College; a veteran of the late war with Spain, in which he served in Company B, Thirteenth Regiment Pennsylvania Volunteer Infantry, and since the close of that conflict has been adjutant, quartermaster and commander of the General J. P. S. Gobin Camp, No. 41, S. A. W. V. His political affiliation is with the Republican party. At present he is a wholesale liquor dealer in Scranton, Pennsylvania. Previous to entering business for himself he was with the R. C. Wills Company, wholesale liquors, in the capacity of general manager in the liquor department. After resigning his position of general manager he opened up a wholesale liquor business at No. 243 Penn avenue, Scranton. All of the male members of the McLoughlin family followed rail-roading or business, and at present are large property owners at the corner of Scranton and Seventh streets, Scranton. All of the McLoughlin family were of American birth, and baptized in the Roman Catholic faith in St. Peter's Cathedral, Scranton, Pennsylvania. The M. J. Clancy children were also baptized in the same church, and are of the same faith.

## MICHAEL SPORER

A member of a family finding its origin in Bavaria, Germany, Michael Sporer is of Pennsylvania birth, Pennsylvania having also afforded him a wide field for his business career. His present business location is Scranton, where he has resided since 1886, and at No. 921 South Webster avenue, he and his four sons conduct a large and flourishing meat business, of which he has been proprietor for nearly a quarter of a century. He is a merchant of Scranton whose efforts have met with the public favor that brings success, and through a business policy in which honor and fair dealing have been conspicuous has attained material prosperity. He is a son of John Sporer, born in Bavaria, Germany, in 1818, died in 1905. He came to the United States in 1845, when a young man of twenty-seven years, and after being employed for a short time in New York moved to Honesdale, Pennsylvania, where he worked on the Delaware and Hudson Canal. Abandoning labor of this kind, he purchased a farm in Cherryridge township, Wayne county, and there engaged in farming operations until his retirement in 1893, his death occurring at the advanced age of eighty-six years. John Sporer married Kate Gumler, a native of Bavaria, Germany, and had children: 1. George, died aged sixteen years. 2. Christina, married Joseph Dink, of Honesdale, Pennsylvania, and is the mother of: Christina, Joseph, John, Michael, and William. 3. Kate, deceased. 4. Margaret, married and lives at Honesdale. 5. Mary, married Frank Dukes, of Scranton, Pennsylvania, and has issue: Lizzie, William, Florence, Robert, Frank, Henry, and Marie. 6. Michael, of whom further. 7. Theresa, married John Steggner, a merchant of Honesdale, Pennsylvania, and had children: John, Frank, Noah, Robert, and Edwin.

Michael Sporer, son of John and Kate (Gumler) Sporer, was born in Honesdale, Pennsylvania, April 16, 1860, and was there a student in the public schools. Until he was eighteen years of age he was thus occupied, working for a part of the time on his father's farm, and then became a butcher, being identified with meat dealing in Honesdale, Carbondale, Dunmore, Hawley, and other places, subsequently passing one year in the John Cookenberger Brewery. His next situation was with Joseph Herzog, a meat merchant of Honesdale, Pennsylvania, and while thus employed he married, in 1886 moving to Scranton and being for one year and a half associated with the firm of T. Carr and Son. He spent about the same length of time in connection with Patrick Joyce, and was then for three years with Joseph Carolan, at the expiration of that time purchasing the business of his employer. The location of Joseph Carolan's meat market was No. 921 Stone street, now South Webster avenue, and here Mr. Sporer continues the business founded by Mr. Carolan. Steady growth has resulted from tireless attention to the needs and desires of his patrons, and Mr. Sporer has now associated with him in the management of the business his four sons. While catering to the public, Mr. Sporer has become an observant and watchful merchant, and, in the deviations he has made from the regular lines of trade has been rewarded by the approval of his patrons and a constant increase in trade. His four sons are his able assistants, their services possessing particular value because of their interest in still further developing the result of his industry and unremitting toil. Mr. Sporer is a member of St. Mary's Roman Catholic Church, and belongs to St. Mary's Society and to St. Peter's Society. His political preferences are strongly Democratic.

He married Marguerite, daughter of John Langendorfer, a native of Germany, and has children: 1. Joseph, associated with his father in business,

married Leopoldine Hershler, and is the father of: Dorothy, born February 13, 1910; Joseph, born March 31, 1912; Edwin, born March 23, 1914. 2. Edward, associated in business with his father, married Annie Ramminger. 3. Alfred, associated in business with his father. 4. William, associated in business with his father. 5. Florence, married Oscar Grambo, a photographer of Scranton, and has one son, Ralph. 6. Francis.

---

#### PATRICK FRANCIS DUFFY

There is, in the history of this branch of the Duffy family in America, an example of the most steadfast loyalty to an employer. Patrick Francis Duffy of this chronicle can boast of forty-six years and five days continuous service with the Delaware, Lackawanna & Western Railroad, during which period he was almost constantly at his post, one of the most faithful and trusted of the army of men in the employ of the company.

County Mayo, Ireland, is the locality claimed by the Duffy family as the original family seat and it was from this place that Michael, father of Patrick Francis Duffy, came to the United States. He was but a young man at the time of emigration, and soon after his arrival in New York he married Bridget Connor, also born in county Mayo, Ireland. The young couple lived in New York for three years after their marriage, then moved to Carbondale, Pennsylvania, where they were among the first settlers in the village. Michael Duffy obtained employment in the coal mines and for forty years was so engaged. Thanks to an exceptionally strong constitution and a life of upright and correct habits, he escaped the heavy toll usually levied by the mines upon their workers and lived to the old age of eighty-three years. His wife died in October, 1911, at the advanced age of ninety-three years. Of their children six grew to maturity: James, of Scranton; Thomas, deceased; Patrick Francis, of further mention; John J., of Sayre, New York; Michael J., deceased; Austin F., of Scranton.

Patrick Francis Duffy, son of Michael and Bridget (Connor) Duffy, was born in Carbondale, Pennsylvania, July 23, 1849. He attended the public schools of Scranton and received instruction under John Kelly, P. J. White and Thomas Loftus. His assistance in the support of the family being needed, he secured employment in a breaker, remaining at mine labor for a period of eighteen months. He then drove mules on the Delaware & Hudson Canal for two years, and after his parents moved to Scranton he drove mules for a time in Clarke's mine in Providence. The associations of mine labor not being congenial to him he permanently left this field and entered the employ of the Delaware, Lackawanna & Western Railroad, as brakeman, remaining with that company until 1909, at which time he completed the term of service mentioned previously. The first seven years as brakeman and the last twenty-five in the first class passenger service as a conductor and for the last ten years of this time conducting the train known as the Queen City Limited. In 1909 he was the candidate of the Democratic party for treasurer of Lackawanna county and was elected by a plurality of three thousand and eight. He discharged the duties of this office in a most satisfactory manner, his reports containing clear and minute information as to the disposal made of every penny of public money intrusted to him. In August, 1913, he was a candidate for the Democratic nomination for sheriff, running for the nomination on the strength of the public service rendered in the capacity of county treasurer, his record in that office being an eloquent plea for the opportunity for still further service. Mr. Duffy is a member of the Order of Railway Conductors, an association formed in his railroading days.

Mr. Duffy married Catherine, daughter of Thomas O'Connor, born in Chesterfield, England, and of their fourteen children nine are living: Thomas; Dr. Michael A.; May, married M. T. Howley, of Scranton; Patrick Francis Jr.; Robert, deputy county treasurer; James; Elizabeth; John; Dorothy; Joseph, all of Scranton.

Mr. Duffy, at the age of sixty-four years, is still in the freshness and vigor of the prime of life, a heritage from a family noted for its longevity. His retentive memory holds many interesting anecdotes of the early days of the region, a small volume of his reminiscences having been published. He is a striking figure, his genial features crowned with a wealth of gray-white hair, and is universally liked throughout the county.

---

#### VITO CAMARCA

Numbered among the numerous tailoring fraternity of the city of Scranton is Vito Camarca, who conducts a profitable business at No. 1202 Luzerne street. He is a son of Francisco Camarca, born in Baccacia, province of Avellino, Italy. His father learned the trade of stone mason early in life and was so engaged in his native land nearly all of his life. He married Francisca Donatiello, Vito being the only survivor of their children.

Vito Camarca was born in Baccacia, province of Avellino, Italy, June 2, 1884. For five years in his youth he attended the public educational institutions of his birthplace, at the end of that time going to Ascoli, Satriano, province of Foggia, where in boyhood he began to learn his present trade, that of tailor. Impressed, as have been so many others of his countrymen, by the handicaps of the home land and the advantages of the United States, he bent his course thither, landing in New York City on January 23, 1902. For two years that city offered him employment at his trade, and at the expiration of that period he came to Scranton, entering the service of Taylor & Raiper, a tailoring firm of the city, his future employers being John Macucci and B. J. Fusche. It was while he was associated with the latter that he conceived the idea of an independent business, and accordingly invested a large part of the capital he had been accumulating for just such a purpose, his first location being on South Main avenue. This place was satisfactory until the spring of 1914, when he moved into more desirable quarters at No. 1202 Luzerne street, his home also being on the premises, and he remains there to the present time, his business a strong and paying institution. Mr. Camarca holds membership in the Santo Angelo Lombardi Society, Christopher Columbus Lodge, No. 1160, I. O. O. F., and also belongs to the Roman Catholic church. His political faith is Republican. He married Raphaella, daughter of Antonio Catta, of Scranton, and is the father of one son, Frank, born August 20, 1906.

---

#### JENNA INTOCIA

In the Intoccia family there exists the condition of father and son, separated by more than three thousand miles of land and water, industriously pursuing the same calling. Conditions in the new world being so undeniably superior to those in the old world, it is but natural that he on this side of the wide Atlantic should have prospered beyond the aspiration of his sire, though their skill be equal. Gaeton Intoccia, father of Jennar Intoccia, was born in Santangelo, province of Napoli, Italy, and there learned the tailor's trade, being engaged in that business in his native city at the present time. He married Antonia Curcio, and had children: Louis and Vincent, shoemakers in the



city of Scranton; Michelena, married a Mr. Manzi, of Scranton; Susan, lives in the homeland; Chiarla, married a Mr. Sagesse, and lives in Italy; Jennar, of whom further.

Jennar Intoccia, son of Gaeton and Antonia (Curcio) Intoccia, was born in Santangelo, province of Napoli, Italy, January 22, 1886. He was educated in the schools of his native land, in 1902 sailing for the United States on the Italian steamer "Germania," arriving in New York City on May 24, of that year. He came directly to the city of Scranton, opening a tailor shop on the West Side, having learned his trade from his father. Quality of work, skill of labor, and close attention to all branches of his business have attracted to his shop generous patronage, retained by the same high grade of work. Mr. Intoccia, an Independent in politics, holds membership in St. Lucia's Roman Catholic Church, and among the several fraternal orders in which he holds membership is the Fraternal Order of Eagles. He also affiliates with the Santangelo Society and the Mazzina Society.

Mr. Intoccia married Anna, daughter of Anthony and Alessandra (Curcio) Magnotta, the former named a contractor of Scranton, her family having been connected with the contracting interests in the city for more than thirty years. Anthony and Alessandra (Curcio) Magnotta are the parents of: Philomena, Mark, Michael, Joseph, Albert, Angelina, Susan, Anna, of previous mention, married Jennar Intoccia. Jennar and Anna Intoccia are the parents of: Antonetta, born August 29, 1911; Alice, born January 1, 1914.

---

#### NICHOLAS VALLARIO

One of the most successful and best patronized of Scranton tailors, transacting business as Vallario Brothers, is Nicholas Vallario, son of Italian parents and of Italian birth he has made the United States the field of his endeavors and prosperity has attended his well directed efforts. His father, Michael Vallario, was born at Pescopagano, province of Basilicata, Italy, February 2, 1848, and in his early life followed the blacksmith's trade, being at the present time a bank employee in his native land. He married Lucy, daughter of Michael Ciampa, and is the father of: Fabio, born in 1879, associated in business with his brother, Nicholas; Joseph M., came to the United States in 1905, and is at the present time a barber in the city of Scranton; Nicholas, of whom further; Mary Rose, a resident of Italy, the land of her birth.

Nicholas Vallario, son of Michael and Lucy (Ciampa) Vallario, was born at Pescopagano, province of Basilicata, Italy, May 12, 1886, and was educated in the Italian school. Emigrating to the United States in 1903, on December 24, of that year, he came to Scranton, Pennsylvania, immediately finding employment with Nicholas Volo, whose establishment was at No. 1919 Boulevard avenue. His next employer was Mr. Masucci, after which he became associated with Richard Nicholas, a Scranton tailor, a connection continuing for two years. Until September, 1906, he was employed by Telier & Keiper, discontinuing this relation to establish an independent tailoring business at No. 250 Wyoming avenue, first transacting business as "The European Tailoring Company," being thus engaged until July, 1910. At that date he moved to No. 322 Spruce street, in which advantageous location he has since directed a high-class tailoring business as Vallario Brothers. Mr. Vallario acts independently in politics, and holds membership in the Independent Order of Odd Fellows and the Mazzini Society of St. Lucia's Roman Catholic Church.

## ALTON F. KIZER

The head of two textile industries in the city of Scranton, and a partner in the real estate firm of Kizer & Swingle, Alton F. Kizer holds an assured position in the business world of Scranton, and one which fully justifies the spirit of progress and conquest he has displayed. He is a descendant of an old German family.

(I) Abram and Susan (Spangenburg) Kaiser, great-grandparents of Alton F. Kizer, came from Germany to the United States about the year 1770, and settled in Sussex county, New Jersey. There Mr. Kaiser spent his life until his sudden death in early manhood. Children: Jacob E., of further mention; Henry, married Hulda Dilston, and removed to the west; John, married Mary Bartlow; Susan, married Daniel Bronson. After the death of their father, these children lived among English families in that section, and it was at this time that the spelling of the name was changed from Kaiser to Kizer.

(II) Jacob E. Kizer, son of Abram and Susan (Spangenburg) Kaiser, was born in Sussex county, New Jersey, May 31, 1800, died in Pennsylvania, May 26, 1886. In early manhood he removed to Pennsylvania, where he was engaged in farming and lumbering. He married, April 10, 1824, Mary Emery, born August 11, 1806, died June 8, 1870, and had children: Susan Ann, married Jacob E. Myers; John D., of further mention; Zachariah, married Ellen Bartlow, of Kizer, Pennsylvania; Adelaide, married George W. Kipp; Mary, married Henry Lavoe; Jacob, a resident of Ariel, Pennsylvania, married Amanda Emery; Jonathan Emery, deceased, married Ellen Bartlow; Henry, living in Kizer, Pennsylvania, married Ruth Mott Abram, deceased, married Lucetta Swingle.

(III) John D. Kizer, son of Jacob E. and Mary (Emery) Kizer, was born in Sussex county, New Jersey, August 22, 1827. Upon attaining manhood he removed to Kizer, Pennsylvania, and there became an agriculturist and lumberman. He married Phoebe, a daughter of Abram Beemer, of Beemersville, Sussex county, New Jersey. They had children: William W., a miller at Varden, Wayne county, Pennsylvania; Edwin Floyd, president of the First National Bank of Towanda, Pennsylvania, associated with the water company of that city, also interested in railroad projects; Harriet Almeda, married W. J. Cobb, of Scranton; John Dalgren, married Clara Harwood; Augusta, married Morton Arnold, of Waymark, Pennsylvania; Verna, married M. S. Schaffer, of Wilkes-Barre, Pennsylvania; Alton F., of whom further; Sylvania, married Frank Peck, of Peckville, Pennsylvania; Bertha, married Vane Kennedy, of Mount Pleasant, Wayne county, Pennsylvania.

(IV) Alton F. Kizer, son of John D. and Phoebe (Beemer) Kizer, was born in Kizer, Lackawanna county, Pennsylvania, October 23, 1869. His public school education was obtained in Kizer and the Keystone Academy at Factoryville, was supplemented by a course of study in Wood's Business College, after which he taught school for one year. Subsequently he removed to Peckville, where he was for eight years engaged in mercantile dealing. He then removed to Scranton, and two years later established the real estate business which he still continues, having in 1907 joined forces with Mr. Swingle under the firm name of Kizer & Swingle, a partnership that, inducing the most desirable results, exists to the present time, gathering strength and vigor with the passing years. Exclusive of his real estate connections, Mr. Kizer is president of the Electric City Throwing Mills, of Scranton, and of the Throop Silk Throwing Company, of Throop, both of which concerns are flourishing and substantial enterprises, and under his able guidance enjoy successful continuance. Mr. Kizer is identified with the Masonic Order, being a charter

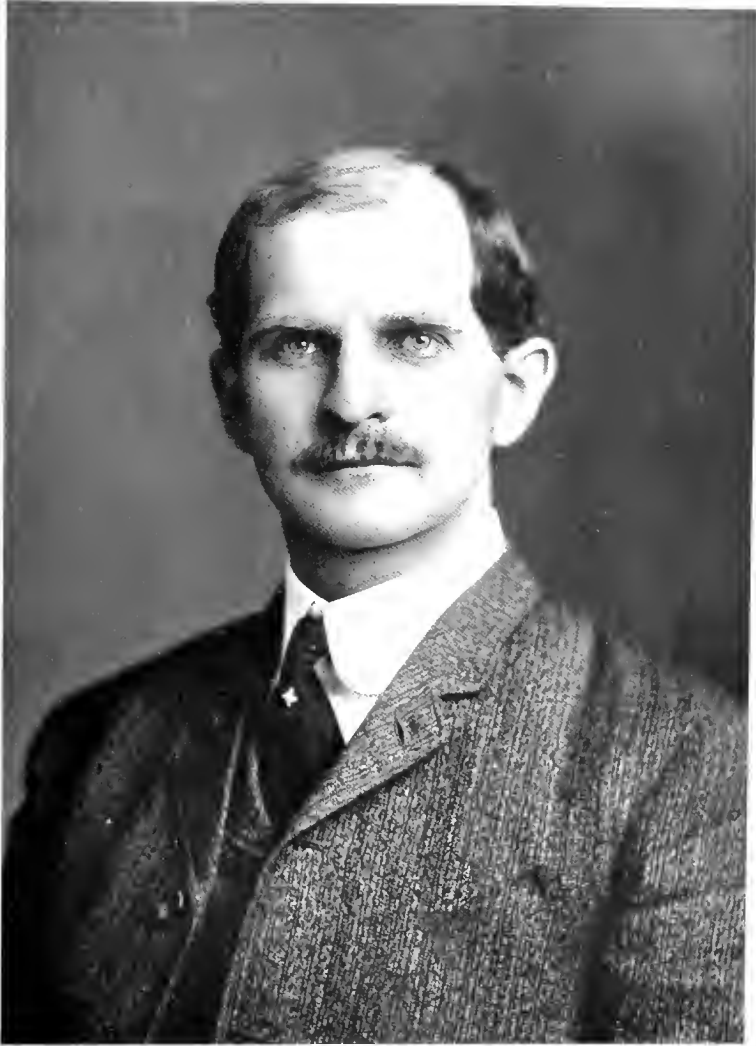

*B. F. Kizer.*



member of Oriental Star Lodge, No. 588, F. and A. M., of Peckville, Pennsylvania; Lackawanna Chapter, No. 185, R. A. M., of Scranton; Melita Commandery, No. 68, K. T.; and Irem Temple, Ancient Arabic Order Nobles of the Mystic Shrine, of Wilkes-Barre. He is a member of the Second Presbyterian Church, and his political convictions are those of the Republican party. He married Frances B., a daughter of Erskins and Etta (White) Squires, her mother a lineal descendant of Peregrine White, the first child born in the Plymouth Colony. Children of Mr. and Mrs. Kizer: Earl Squires, born July 31, 1905; Margery Louise, born July 31, 1909.

---

### CHARLES JOSEPH CASSESE

Although a native born son of Scranton, Charles J. Cassese is of Italian parentage, a descendant of an old family of Italy. His grandfather, Anthony Cassese, was a miller of Italy, where he lived his entire life save two years spent in the United States, during middle life. He married and left issue: Joseph Anthony, of whom further, Vincent, Camilla, Matilda, Philomena, Margaret, all living in the United States.

Joseph Anthony Cassese was born at Pescopogano, province of Potenza, Italy, in March, 1863. He came to the United States in 1877, first settling in Pittston, Pennsylvania, later coming to Scranton. He was a shoemaker by trade, having his first shop in a room under the St. Charles Hotel on Penn avenue. He there prospered and in a few years abandoned his trade, opening a grocery store on Linden avenue, where he continued until 1887. He then became proprietor of Cassese Hotel and Restaurant at No. 103 Lackawanna avenue, and also engaged in a banking and foreign exchange business. He also had a wholesale grocery at No. 99 Lackawanna avenue, and here he died, December 18, 1913.

He was a member of Scranton Lodge, No. 123, B. P. O. E. He was much interested in the welfare of the city and its charitable work, and gave liberally of his means. He was a member of a number of Italian societies and took an active part in church work. He was one of the oldest of the Italian residents, one of the most successful, and was consulted by his fellow countrymen whom he was willing to help in any way. He married Rose, daughter of Carl and Grace Carlucci, of Scranton; children: Anthony J., Charles J., of whom further; Frank, Jennie, Michael, Grace, Angelina, Vincentina, Joseph Anthony.

Charles Joseph Cassese was born in Scranton, Pennsylvania, January 3, 1889. He was educated in the public schools and is a graduate of the Scranton Technical High School, class of 1907. He was his father's confidential clerk for some time, later became general manager of his varied business interests. He is a member of the Benevolent and Protective Order of Elks, the Independent Order of Odd Fellows, the Scranton Canoe Club and Saint Lucia's Roman Catholic Church.

---

### SALVATORI PALUMBO

Throughout Scranton there are many evidences of the work that has been conducted by Salvatori Palumbo, in the form of office buildings, schools, churches, and municipal improvements, all completed within the short space of four years. Mr. Palumbo is a native of the Island of Sicily, born October 25, 1873, and grew to manhood in his native land. He enlisted in the Italian army, serving for three years, and during that time fought in the Abyssinian War. In 1896 he immigrated to the United States, landing in this country on

Thanksgiving Day. He proceeded immediately to Scranton, Pennsylvania, and was employed by Burke Brothers, well known contractors of that place. He then became foreman for Michael Ruddy, of Scranton, remaining with him for two years, spending the two following years in the service of the Westinghouse Electric Company, in the construction of the power house and depot at Wilkes-Barre. Mr. Palumbo then formed a partnership with his half-brother, Frank Ricca, a mason contractor of Scranton, but this relation was discontinued at the end of the year, Mr. Palumbo becoming superintendent of Mr. Ricca's operations, a position he held for a period of six years, at the end of which time he decided to establish in the same business independently. In 1910 he opened an office in the Real Estate Building of this city and from the first prospered, the four years that he has been in business having witnessed the satisfactory execution of numerous large and difficult contracts. Among these are the dressed stone wall at Mount St. Mary's, reputed to be the largest dressed stone wall in the state, the Mazzini Building on Pittston avenue, the Archbald Bank Building, the Hess Theatre Building on Pittston avenue, the Franklin Apartment Building on Franklin avenue, the Survaiz Building, the Jewish Synagogue on Linden street, the Latori Building on Pittston avenue, St. Michael's Church of Olyphant, the stone work on Clark and Snovers office building, and the foundation of the high school building at Old Forge. Among the municipal contracts that have been awarded Mr. Palumbo are the Elm street culvert and the stone bridge on Rockwell street. His political party is the Republican, and he belongs to the Builders' Exchange, the Mazzini Society, the Fraternal Order of Eagles, and the Benevolent and Protective Order of Elks. He holds membership in St. John's South Side Roman Catholic Church.

Mr. Palumbo married Josephine, daughter of Salvatore Abbate, of Italy, and has children: Mary, Josephine, Salvatori, Saverio, Frank, Nunciata, Theresa, John.

---

#### GIUSEPPE BLANCA

Giuseppe Bianca, son of Salvatore Bianca, was born in Cefalu, province of Palermo, Italy, December 6, 1863. His father, a carpenter by trade, was one of three children, the two others being Carmelo and Guiseppe. Salvatore Bianca passed his entire life in his native land, married Rosaria Greco, and had children: Theresa, married Francisco Vazzano, and had a son who served in the Italian army: Seraphena, Salvatora, Rosaria, Rosena Victoria, Salvatore, Giuseppe, of whom further; Francisco.

Giuseppe Bianca was born December 6, 1863. He attended the public schools of his native land, in 1890 immigrating to the United States, the vessel in which he sailed arriving at New York City, March 28, 1890. In the homeland he had become a proficient master of the stonecutter's trade and was thus employed in New York and other places. Since coming to this country he has made one visit to the land of his birth, returning April 28, 1896. Entering the employ of Carlucci Brothers, the prominent stone-cutting firm of this city, he worked on numerous large contracts in New York and other large cities, and after ten years in the employ of this concern decided to establish independently, in 1904 beginning the operation of a stone-cutting plant in Dunmore. For five years he was located in this place, in 1909 erecting a stone building at No. 909 West Lackawanna avenue, where his plant was installed on September 1, 1909, and here at the present time he performs stone cutting of all kinds, making a specialty of fine monumental work. He is recognized as one of the most artistic and accomplished artisans in his line, a great deal

of his work gracing public places of the vicinity. Mr. Bianca holds membership in the Modern Woodman of the World, the Fraternal Order of Eagles, the Victor Immanuel Society, and for two years was president of the Cecelia Society. He supports the Republican party, and belongs to St. Lucia Roman Catholic Church.

Mr. Bianca married Rosolia Vazzana, born in Italy and has children: 1. Rosaria, married G. Mira, and is the mother of Mamie, Lena, Joseph. 2. Salvatore, born February 22, 1890, attended public school No. 10 of Scranton until he was eighteen years of age, having been since associated in business with his father. 3. Vincenzo, a barber of Scranton. 4. Joseph, a carpenter of Scranton. 5. 6. 7. Caroline, Frank, and Josephine, students in public school No. 15.

---

#### APPIO C. DeBLASIIS

Appio C. DeBlasiis is a son of Nicholas DeBlasiis, a native of Lucito, province of Campabasso, Abruzzi, Italy. Nicholas DeBlasiis in youth learned the shoemaker's trade, which he follows in the homeland at the present time. He married Giovannina Minicucci, and has children: Joseph, engaged in business in New York City; David, a resident of Glens Falls, New York; Caroline, married a Mr. Predimonti, and lives in Naples, Italy; Appio C., of whom further.

Appio C. DeBlasiis, son of Nicholas and Giovannina (Minicucci) DeBlasiis, was born in Lucito, province of Campabasso, Abruzzi, Italy, March 6, 1883. After attending the public schools of his birthplace for five years, he learned the tailor's trade, coming to the United States in 1900. He arrived in New York City on March 23 of that year, and for eight years followed his chosen calling in that place, being employed by several of the best known tailors of the city and perfecting himself in the branches of his trade peculiar to this country. From New York he went to Wilkes-Barre, Pennsylvania, tarrying in that city for a year and a half, coming to Scranton on September 22, 1909, entering the shop of L. B. Mosher, a tailor of excellent repute in this city. His advance into independent operations was made in August, 1913, when he opened a tailor shop at No. 109 Wyoming avenue, in which place he has since been located, his trade steadily increasing. He is an accomplished workman, proficiency gained by diligent application to his line, and although he had long desired to be the proprietor of a shop he refrained from taking this important step in his business career until he was confident that in no way could he better prepare himself therefor, and strong in his ability he entered the business world, where his reception of the past year has been most cordial. Mr. DeBlasiis became a naturalized citizen of the United States in April, 1911. He is a member of the Roman Catholic church, an Independent in politics, and belongs to Christopher Columbus Lodge, No. 1160, I. O. O. F. He married Marion, daughter of Casper and Franca Noto, and has one daughter, Genevieve, born January 26, 1912.

---

#### ERNESTO M. LETTIERI

Beginning humbly in the land of his adoption, although a man of good education and family, Mr. Lettieri by availing himself of the facilities offered by that noble institution, Cooper Institute, New York City, soon acquired American methods and speech, and quickly rose to a position in keeping with his qualifications. He is the son of Joseph M. Lettieri and a grandson of Dr. Vincenzo Lettieri, the latter an Italian physician of distinction. His chil-

dren, Salvador, Joseph M., Antonio and Marianna, all reside in their native land. Joseph M. Lettieri was born in Rapone, Potenza, Italy, served with the rank of captain in the war of 1870, became a lawyer of note in his native city, accumulated considerable property and is now living a retired life. He married Marie, daughter of Vita Santoro, and has three children: Vincenzo, appointed forestry inspector by the King of Italy, still resides in his native land; Ermenia, married and resides in Rapone, Ernesto M., of whom further.

Ernesto M. Lettieri, born in Rapone, Potenza, Italy, January 2, 1872, was educated in the Seminary of Muzo Lucano, and at the Royal Technical School at Melfi, a graduate of the latter school in 1889. In 1890 he went to Paris, France, where he was employed for six months, then came to the United States, sailing from Havre and landing in New York. On arriving at the latter city he found employment as a waiter. He at once enrolled in a class at Cooper Institute and in a short time had acquired both language and business habits so well that he secured a position as traveling salesman. In the year 1900 he came to Scranton, Pennsylvania, and shortly afterward was appointed court interpreter, through the friendship of John R. Jones, the well known Scranton attorney. Having the necessary education and ability, Mr. Lettieri saw the opportunities the city offered and soon decided to engage in business. He secured a location on Lackawanna avenue and after obtaining agencies from several large steamship companies, opened an office for the sale of foreign exchange and steamship tickets. He later became agent for several importing firms and in these lines has built up a prosperous business with his countrymen and others. He became a naturalized citizen of the United States, August 9, 1905, and is a supporter of the Republican party.

He married Mary Farrell, born in England, and has children: Nellie E., Clara, Florence, Joseph, Helen, Henrietta, Vincenzo, George.

---

#### PIETRO LEGAMBI

The Legambi family of Italy, represented in the city of Scranton by Pietro Legambi, are of French descent, the ancestor who settled the line in Italy being Enrico Legambi, a member of the French nobility. Upon coming to Italy he made his home in the city of Cefalu, province of Palermo, where the family seat has since been located. During the wars for Italian Independence, General Pastori, commanding an army of one thousand men, entered the city as a defence against the attack of the enemy, and throughout the lengthy siege he and his army were entertained by the members of the Legambi family, then one of the wealthiest and most influential in the locality. During the army's stay in the city a son, Vincenzo Legambi, was born to one of the family, General Pastori standing as its god-father.

Vincenzo Legambi, father of Pietro Legambi, was born in Cefalu, Italy, and became, by inheritance and through the successful administration of his resources, one of the wealthiest land owners of the city, his estate consisting of nearly one-half of the land within the boundaries of Cefalu. He was one of several children, one of his brothers, Savario, being a prominent lawyer, and two others, Salvavia and Francisco, priests. These two latter brothers erected a large church of their faith in Cefalu, wherein they ministered and conducted service for many years. Marionena, a niece of the three aforementioned brothers, married Mr. Musso, a lawyer, at the present time mayor of Cefalu, and a sister married Baron Martino, of that city.

Pietro Legambi, son of Vincenzo Legambi, was born in Cefalu, province of Palermo, Italy, March 1, 1868. His family, once a dominant factor in the life of the city because of its wealth and influence, had lost its prestige and the







*A. Conrad*

greater part of its once vast estate through political plotting and intrigue and marine disasters, and after having served an enlistment in the Italian army, Pietro Legambi became persuaded of the advisability of American immigration. The prospect of a new life in a country where the early glory of his family would be unknown, and his career of his own making, appealed to his ambitious nature, and on March 10, 1898, he engaged passage on a transatlantic liner, landing, after a voyage ordinary in every way, in New York City. He continued to Pittston, Pennsylvania, first being employed in the breaker, after a short time moving to Scranton. He purchased a one-horse team and became a peddler, meeting with such good fortune in the disposal of articles bought from others that he decided to become an importer. His first move toward his present business was the acquirement of title to the property at No. 141 Robinson street, and after making suitable arrangements abroad began the importation and sale of olive oil, his present line. His home in Italy had been in the heart of the olive oil manufacturing district, and, with thorough knowledge of the producing end of the business, he has conducted his retail dealings with advantageous profit. Mr. Legambi, who is politically a Republican, holds membership in the St. Lucia Roman Catholic Church.

He married Carolina, daughter of James Varzana, their marriage being solemnized in Italy. They are the parents of: 1. James, born in Italy, July 4, 1893, educated in the public schools of Scranton and now associated in business with his father. He is a member of the Victorio Alfieri Society, of Scranton, the Avon Dramatic Club, and is a Republican sympathizer. His church is St. Lucia Roman Catholic. 2. John, born in Italy, in November, 1896. 3. Caroline, born in Pittston, Pennsylvania, November 5, 1900. 4. Jennie, born in Scranton, Pennsylvania, November 24, 1903. 5. Frank, born in Scranton, December 21, 1907. 6. Josephine, born in Scranton, July 6, 1909.

---

#### ANDREW CONRAD

Andrew Conrad, late of Scranton, Pennsylvania, was a member of a family which has made its mark in various directions since its advent in this country. He was born in Wuerttemberg, Germany, in the year 1830, died in Scranton, Pennsylvania, August 15, 1905. From his earliest years he displayed an extraordinary love and talent for music, and this talent was cultivated in the best German conservatories of music. In 1855 he came to America with his wife, and for the first two years lived in the city of New York. He then removed to Pottsville, Pennsylvania, from there to Wilkes-Barre, and in 1867 to Scranton, in which city he took up his permanent residence greatly to its benefit. Long before he established a conservatory for the study of music he had gained fame as a violinist and pianist. His successful methods of instruction gained immediate attention, and he had the power of imparting to his pupils his own enthusiasm and love for music. Many of those who commenced their musical studies under Mr. Conrad have since then gained world-wide reputations, and they invariably ascribe a large share of their success to the first principles instilled into them by him. His private pupils and classes were not permitted to absorb all of his time and attention, and he was the organizer of many musical societies, and the organist and choir leader for many years of the German Lutheran church. In 1880 he established himself in business as a general agent for fire insurance, conducted this alone until 1893, when he admitted his son, Otto R., to a partnership, the firm becoming henceforth A. Conrad & Son, and this is still conducted in a most prosperous manner.

Mr. Conrad was married in Germany in 1857 to Catherine Muller, daugh-

ter of Henry Muller, organist of the Lutheran church at Hilburghausen, Saxony, Germany. Children: 1. Matilda, married Lewis Rauch, of Philadelphia, and has one daughter, Lulu. 2. Henry, deceased. 3. Louise, deceased; was the first wife of Dr. Whalan, deceased, had two children: Alma and Bertha. 4. William, of whom further. 5. Louis, of whom further. 6. Charles C., of Scranton, married Blanche Greer. 7. Edward, of whom further. 8. Emma, married Professor Theodore Hemberger, of Baltimore, Maryland, and has children: Siegesfried and Armenia. 9. Josephine, second wife of Dr. Whalan. 10. Otto R., of whom further.

#### WILLIAM CONRAD

The Enderley Dairy, an establishment operating independent of any trust affiliations, drawing from its own farms for its supply, and also from nearby farms, giving employment to thirty-five men, and requiring one three-ton auto truck and fifteen horses to carry its products to its many customers, is the business that was founded when William Conrad, then a young man of twenty-two years, personally carried a scanty quantity of milk to a few patrons. To the upbuilding of this business he has devoted the best years of his life, and its strong, firm, position and sturdy, efficient, organization, are proofs that the fruits of his labors are good.

William Conrad, son of Andrew and Catherine (Muller) Conrad, was born in Pottsville, Pennsylvania, May 6, 1860, in his boyhood attending the public schools of Scranton and a school held in the German Lutheran church, supplementing this training with a course of study in a private German school. On his father's farm he became familiar with dairying, remaining there until he was twenty-two years of age, when he conceived the idea of an independent business in dairying. He began in this line by purchasing a small quantity of milk from M. H. Dale and delivering it to a few customers whose patronage he had previously solicited; a short time afterward, through an expenditure of forty dollars, he became the owner of a horse and wagon. From this investment of forty dollars, which had grown from nothing but his determination to found a business, has come the Enderley Dairy, a strong and flourishing organization, housed in modern and spacious surroundings, and, as before stated, requiring in its operation thirty-five employees, one three-ton auto truck and fifteen horses. Mr. Conrad owns two farms, one at Moscow, the other in Madison township, herds of well-kept and high grade cattle grazing over each and furnishing the pure and wholesome products for which the Enderley Dairy has become noted. Mr. Conrad in 1899 became a member of the Scranton Dairy Trust, three years later withdrawing from membership in that combine, and has since continued in business free from all associations of that nature. Just what amount of satisfaction Mr. Conrad takes in the prosperity of the institution that he founded is known only to himself, but certain it is that a large share of pride in the Enderley Dairy would be not only pardonable, but exceedingly justifiable. Mr. Conrad is a member of the Green Ridge Presbyterian Church, and also of the Scranton Board of Trade.

He married Lydia, daughter of Francis A. Bates, of Scranton, and has one son, Andrew, a student in Keystone Academy, class of 1915, whither he went after completing his course in the Scranton High School.

## LOUIS CONRAD

Louis Conrad, of Scranton, Pennsylvania, whose success in business affairs has come to him through persistent and painstaking labor, reliable methods and honorable transactions, is of German descent.

Louis Conrad, son of Andrew and Catherine (Muller) Conrad, was born in Pottsville, Schuylkill county, Pennsylvania, November 5, 1861. He was five years of age when his parents removed to Scranton, where he received a practical education in the public schools of that city, making the best use of his opportunities while there. His first occupation was that of clerk in a store on Lackawanna avenue, and after working in one position for a period of sixteen years, in the men's furnishing department, he established himself in the same line of business independently, and has been eminently successful in this undertaking. Mr. Conrad had been in the one location, 305 Lackawanna avenue, for the past twenty-five years, but for some time he had felt that his store was not as modern and up-to-date as he would like it to be. Having seen an opportunity for converting the old savings bank building on Wyoming avenue into a men's haberdashery store, he has now one of the most modern, elegant and convenient stores in the state, which he occupied September 1, 1914. He is a man of many sided ability, and has been largely interested in a number of other enterprises. He is a member of the Scranton Board of Trade, and an active member of the Retail Merchants' Protective Association, and is president of this organization at the present time. He has been a member of the Liederkrantz Singing Society for the past thirty years, and is a member of the Masonic fraternity. Politically he is inclined to be Democratic, and has at times been tendered nomination for public office, but has declined the honor, holding that he could best serve the interests of the city by increasing its business prosperity.

Mr. Conrad married, October 26, 1886, Elizabeth Morton, and they have children: Paul M. and Louise M.

---

EDWARD CONRAD

One of those energetic and sagacious business men whose presence in any community imparts a healthy impetus to the current of business affairs is Edward Conrad, of Scranton, whose family, of German origin, has been resident here many years.

Edward Conrad, son of Andrew and Catherine (Muller) Conrad, was born in Pottsville, Pennsylvania, April 12, 1865, and was about two years of age when his parents removed to Scranton. There he received an excellent education in the public schools, and upon the completion of his education entered upon his business career. His first venture was in the milk business with one of his brothers, and when he abandoned this it was to engage in farming, with which he was successfully identified for a period of seven years. Insurance affairs then engaged his time and attention for some time, and in 1910 he established himself in business as an automobile dealer at Nos. 314-316 Adams avenue, Scranton, where he has been located since that time. His residence is at No. 1706 Linden street. In political matters Mr. Conrad is a strong Republican, and his religious affiliation is with the Baptist church. He married, in 1910, Clara Woodhouse, and they have had children: Harold, Edward, Joseph, Arthur.

## OTTO R. CONRAD

Otto R. Conrad, youngest child of Andrew and Catherine (Müller) Conrad, was born in Scranton, Pennsylvania, October 16, 1871. He inherited a love and talent for music, both vocal and instrumental, and received instruction under the direction of Professor Bauer. After completing his studies in the Scranton public schools and business colleges, he became associated with his honored father in the insurance business, the firm becoming A. Conrad & Son, General Insurance Agents. This business, founded by the elder Mr. Conrad in 1880, is still one of the leading insurance agencies of Scranton, and Otto R. Conrad is the able manager. He was exclusively connected with the insurance business until 1902, when he became the local agent for the Pierce-Arrow Automobile Company, retaining that agency until 1904. In 1905 he became a distributor for the Ford Motor Company for the counties of Lackawanna, Wayne and Susquehanna. This agency he has developed into one of the strongest, his sales for 1912 reaching well toward the five hundred mark. The popularity of the Ford is nowhere more strongly manifested than in the territory covered by Mr. Conrad and his force of twenty-five men in field and garage. His business for 1913 was three times that of 1912 and will probably equal the combined sales of the other makers. Steel and wood combined, we care not how skillfully, into no matter how perfect a machine, cannot demonstrate their own perfection, but must have the hustling, energetic business man and selling force to prove their merit and find a buyer. This Mr. Conrad has furnished in his field, and to the man whose brain and energy have placed him in the foremost rank of automobile dealers, all praise is due. He is also a director of Green Ridge Bank, vice-president of the German Building Association, director in the Scranton Board of Trade, director in the Scranton Industrial Development Company, member of the Association of Automobile Dealers, and is an active member of the Young Men's Christian Association, Schiller Lodge, Free and Accepted Masons, and the Green Ridge Club. In religious affiliation he belongs to the Green Ridge Presbyterian Church, and is a teacher in the Sunday school connected with it. Mr. Conrad's entire life has been spent in the city of Scranton, excepting the years of 1904-05. During that period he was manager for the Germania Life Insurance Company for Northeastern Pennsylvania, with headquarters at Philadelphia, and the following year after his father's death, he returned to Scranton to look after his many interests here.

Mr. Conrad married Kathryn, a daughter of George H. Palmer, who is associated with Mr. Conrad in the insurance business. Mr. and Mrs. Conrad are blessed with a happy family of four children, and have made their home in the Green Ridge section of the city for many years.

---

HARRY F. SMITH, M. D.

Among the most eminent physicians of Scranton at the present time is Dr. Harry F. Smith, a native of that city, where he was born August 23, 1883, being the son of Frederick D. and Emilie Longstreet (Berstein) Smith, old residents of the place.

He received his education primarily in the public schools of Scranton, having graduated from the high school in 1903. After the completion of his general education he decided to take up the study of medicine with the idea of becoming a physician, and accordingly entered the Medico-Chirurgical Medical School at Philadelphia, Pennsylvania. He completed the full



Otto R. Conrad





four years' course here, graduating in 1907, and receiving his degree of M. D. He was extremely popular with his classmates and entered into the social life of the school while in Philadelphia, being a member of the Greek letter fraternity, Phi Rho Sigma; and enthusiastic in all sports and athletics in which the students engaged. He was a member of the football, basketball and track teams, and became an excellent athlete. In his studies he won distinction, and while in Philadelphia was a member of the W. L. Rodman Surgical Society, and of the George H. Meeker Society, being secretary of the latter.

Immediately after his graduation he entered the Stetson Hospital as interne, remaining there for six months, when he became engaged as company physician for the Markeloe Mining Company, with whom he continued for the subsequent eighteen months. After this he came to Scranton, where he established himself in general practice, and has remained here with great success ever since. He has made an exceptional record considering the short time he has been a practicing physician, and is associated with a number of the hospitals here in various capacities of trust. He is a member of the staff of the West Mountain Hospital, also of the Scranton State Hospital, and belongs to the Lackawanna County, Pennsylvania State, and American Medical associations. Belonging to the organizations of the Knights of the Mystic Chain and the Patriotic Order of the Sons of America, he is a member of the medical and hospital corps of these bodies, and is very active in their interests; indeed, he has become one of the best known and most esteemed members in the state, and his services are held in high repute. He is surgeon to the police force of Scranton, also to the fire department, and is the appointed physician to the school board, and surgeon to the Delaware, Lackawanna & Western Railroad.

Dr. Smith is a Republican in politics, and is a very active member of the party in local affairs. From the year 1904 until 1907 he served on the State Guard staff, and in all military matters takes an active and enthusiastic interest. In 1912 he was appointed first lieutenant, Medical Corps, and assigned to the Thirteenth Infantry Regiment, Scranton. He is a member of the Presbyterian church, as is also his wife, who was Miss Celia B. Rine, daughter of Edwin M. Rine, general superintendent of the Delaware, Lackawanna & Western Railroad, one of the most influential and wealthy citizens of Scranton. Dr. Smith appears to have before him a brilliant future, successful in his practice, popular among his fellow citizens, and eminent by way of his social and personal qualifications. He is one of the professional men to whom Scranton looks for added lustre in its place among the cities.

---

#### DAVID M. REILLY

One of the oldest retail shoe dealers in Scranton, Mr. Reilly is one of the successful business men of the city, although a man just in the prime of life, the word "oldest" being used in a business sense only. His training for the retail shoe business was under the pioneer merchant of Lackawanna avenue, South Side, and continued as a member of the firm of Lewis & Reilly until two years ago, when after a quarter of a century in business he established his present business under his own name alone. Brought up through early life in the hard school of adversity, he has as boy and man won name, standing and success by earnest, well-directed effort, a careful husbanding of his resources, and an honest ambition to earn his place in the mercantile world.

Mr. Reilly's start in life was an humble one. His father, Thomas Reilly, was a native of county Mayo, Ireland, his mother of county Sligo. On

coming to the United States he worked on the Delaware and Hudson Canal at Honesdale, later was a miner at Archbald, also helped to build the old Gravity Road. The latter years of his life were spent in Scranton, where he died aged about sixty-five years.

David M. Reilly was born in Archbald, Pennsylvania, May 8, 1865. He attended the public school there for several years, leaving at one time to work as a "breaker boy," but a few weeks' experience was enough and he returned to school. Later he worked for a time in the coal mines, but did not like the life of a miner, and in 1881 he came to Scranton, a lad of sixteen years. He secured a position in the shoe store of Morris Goldsmith, as clerk, continuing until he had completed plans for going into business for himself. On December 15, 1888, the firm of Lewis & Reilly opened a retail shoe store in Wyoming and there began a successful business career, the firm continuing as founded until Mr. Reilly withdrew, disposing of his interest to a brother of his former partner. Mr. Reilly then opened his present retail shoe store in the Jermyn Hotel block and there continues in prosperous business. He has been connected with the retail shoe trade in Scranton thirty-two years, and of these years a full quarter of a century has been spent in his own stores as partner and sole owner. He is a director of the Scranton Savings and Dime Bank and is a member of the Board of Trade. He is interested in public affairs, and as a good citizen supports with his vote the candidates that appeal to him as best fitted for the office they seek.

Mr. Reilly married Ella, daughter of Equire Patrick Loftus, of Olyphant. Children: Gertrude, married James Corbett, of Scranton; Joseph; Thomas; Maria, member of the class of 1915, Teachers' College of Columbia University; David; James.

---

### JOHN T. WATKINS

Popular acclamation at home as the greatest of choral leaders, high recognition by critics abroad, and general approval by all, is the enviable estimation in which John T. Watkins, of Scranton, is held by lovers of music on both sides of the Atlantic. Emerson, tersely and epigrammatically, has described music as "the poor man's Parnassus." If this be true, and the dean of American poets was remarkably exact as well as poetic in his expression, the thousands that have been brought to a true appreciation of and love for the best of the world's music, through the wise and tasteful guidance of John T. Watkins, must indeed be refreshed by the nectar and ambrosia of the gods. He it is who has raised the standard of musical achievement of Scranton from a depth lower than mediocrity and has placed it in the front rank of the highest class of cities interested in music; who has developed in the city a choir unrivalled, and who has brought fame and reputation to many individuals by the expert manner in which he has brought out all the latent possibilities of tone and volume in their voices and introduced them to the public as soloists of merit. But a word as to the parentage and career of the man who has reached these heights and has deserved this mention.

John T. Watkins is a son of William Wynn Watkins. William Wynn Watkins was a native of Merthyr-Tydfil, county of Glamorgan, South Wales, where he was a miner by occupation, and he came to the United States in 1860. He spent about a year in Pittsburgh, Pennsylvania, and at the outbreak of the Civil War returned to his native land, as the excitement attending the beginning of hostilities had demoralized trade conditions and

industries were at a standstill. He is in no way open to criticism or censure for his course in this matter, for he had come to a new country for the purpose of working to support his family, not of fighting, and in the internal differences of our country he had no part. After the restoration of peace and the attendant activity in the industrial world, he came to Scranton and there obtained employment in the mines, an occupation in which he was experienced and which he followed all his life. It was in the pursuit of this calling that he met his death. He was hastening to the surface, after working hours, in order to attend a musical festival in which his two sons, John T. and Thomas, were to lead rival choruses in a singing contest, when he stepped upon a cage, which without his knowledge had been set in motion. The moving cage hurled him against the roof of the mine, causing instant death. His untimely death cut short a career that was destined to be of rich benefit to many. Both he and his wife belonged to the Baptist church, in the Sunday school of which he had for many years been the teacher of a class of young men, whose feet he had guided into a path offering aid against temptation and strength to do the right. It was by these members of the rising generation that his death was felt more deeply than by any excepting the members of his immediate family, he having been more to them than their instructor, their counsellor and friend, whose advice and help was ever theirs. He was a staunch Republican and from the depth of his convictions often took the stump to extol the worth of a candidate or to defend one of the party's principles. He was an earnest, forceful speaker, on occasion eloquent and emotional, and performed excellent service for the party.

He married Jane, daughter of John T. Jones. Children: 1. Thomas, deceased; was a druggist, and also a musician of note, who, besides attending to his drug business, taught music in the Olyphant public schools. 2. Rev. M. J., deceased. 3. Sarah, married John W. Reese, deceased; he was a prominent office holder and public servant of Taylor. 4. John T., of whom further. 5. William M. 6. James E., an attorney of Scranton. 7. Edith, married W. H. Peterson, supervisor of a division of the Western Union Telegraph Company. 8. Gertrude, married Sydney Owens, foreman Great Bellevue mines of the Delaware, Lackawanna & Western. 9. Richard, a musician and post office employee of Scranton.

John T. Watkins, son of William Wynn and Jane (Jones) Watkins, was born in Merthyr-Tydfil, county of Glamorgan, South Wales, June 9, 1862. His early life gave little indication of the triumphs that were to be his in the future, his early education being curtailed so that he might obtain employment in the breaker near the mine in which his father worked. At the age of eight years he entered upon this employment and was variously engaged in mine labor until he was nineteen years of age. During these years he was constantly bent upon acquiring an education, always a sign of well-directed ambition, and performed that task in different ways, attending the public schools when the mines were idle, going to night school in Taylor borough, and by many methods picking up odd bits of information and knowledge that he carefully stored away in memory's files for the time when they would be useful to him. His natural talent and taste for music were early shown, and he came under the training of an old miner, David T. Davis, chorister in the local Baptist church, who gave him his first instructions in harmony. Hand in hand with his innate love of music was an equally strong fondness for the poetic, and he made extensive study of the works of the best of the English poets, Browning, Milton, Shakespeare and Tennyson being his favorites. Another earnest of his desire for education was the fact that when he was seventeen years of age he walked from Taylor

to attend the night sessions of Gardner's Business College, and home again at the close of the class. There were no transportation lines connecting the two places, which was to him a comfort, since he could not have afforded the expenditure for carfare. After graduating from this institution he gave up his employment in the mines and entered the office of E. P. Kingsbury, then city controller, later accepting a position with James J. Lawler as accountant, in whose service he remained for twelve years. During all this time he was constantly studying music and singing, and in order to improve his pronunciation and enunciation, he studied elocution under Colonel J. A. Price. As a lad he had attended the services of the German Sunday school for the sake of acquiring an inkling of that tongue and later improved his knowledge of the language. The possessor of a fine baritone voice, he not only had exceptional ability as a soloist, but was remarkably successful in getting the best results from a body of singers, being able to impart to them the knowledge of technique and expression he so readily acquired, and with sympathetic understanding encouraged them to the best efforts within their power. When not yet of legal age he had begun to lead choirs, and from his earliest attempts gave evidence of the qualities of leadership that have since made him famous in his profession.

His first public conquest of note was in 1883, when a male chorus trained by him won the first prize in their class at Wilkes-Barre. Increasing in prominence in his chosen art, in 1892 he organized the Scranton Choral Union and managed it on a trip to the Columbian Exposition at Chicago, where, under the leadership of Hayden Evans, with Mr. Watkins as assistant director, the Union won the first prize of five thousand dollars, in competition against such organizations as the Cymrodorians, of Hyde Park, and the famous Mormon choir from Salt Lake City. In 1895 he organized and conducted the Scranton United Choral Society, which captured both the first and second prizes at Wilkes-Barre, besides which several of the members of the Society whom Mr. Watkins had trained were awarded prizes in the solo contests. During these years he had also been acting in the capacity of coach in the amateur performances given in the city, often taking leading parts. Among the light operas rendered under his direction were the "Mikado," "Pinafore," the "Chimes of Normandy," "Pirates of Penzance," and also several sacred cantatas, all of which scored complete successes, and all of which added lustre to the honor of his reputation. In 1896 he entered the Royal Academy of Music at London as a student in voice, piano, harmony, elocution and dramatic art. He followed his studies assiduously, gradually perfecting himself in the different departments, and in a contest between twenty-five persons was chosen soloist in the choir of St. James' Church, at Piccadilly, one of the wealthiest and most fashionable churches of London, known far and wide for the beauty of its service. While in London he progressed so far in his art and was so deeply interested in it that he was given the privilege of playing at Her Majesty's Theatre, in a minor part with Beer Bohm Tree. For two months he was in the theatre and during that time played more prominent parts in Shakespearian productions, including "Romeo and Juliet," "As You Like It," and "Julius Caesar." While interpreting the part of the Duke in "Duke Aranza" at a week's engagement in Ealing, the popular English actress, Ellen Terry, known in private life as Mrs. E. A. Wardell, was present and tendered him her compliments for his excellent interpretation of the difficult character. Another of his European triumphs was in a contest for the position of bass soloist at the Mount Street Jesuit Church, when, from seventy-four competitors, he was chosen for the place. Just before leaving London, he was pre-

sented by the Royal Academy of Music with two bronze medals, and in recognition of his successful record at the Academy, he was chosen to sing at the school's concert at Queen's Hall and again at St. James' Hall, one of the highest of valedictory honors.

In 1897 Mr. Watkins returned to Scranton, where he met with an enthusiastic reception at the hands of his many friends, who had followed his career abroad with pride and satisfaction in the achievements of their fellow-townsmen, opened a studio in the city, and has since continued there, teaching music and conducting choral societies. In 1902 Mr. Watkins met the great conductor of the Chautauqua Summer School, Mr. Hallam, also Henry Walter Hall, of Columbia University, in competition in Brooklyn, New York, when, as leader of the Scranton United Choral Society, his chorus won the first prize at the Brooklyn Arion Festival, as well as carrying off the honors in the Ladies' Chorus competition. Here his Schubert Male Quartette almost completed a clean sweep of the prizes by being awarded both the first and second, singing selections in English and German. The record of the Scranton United Choral Society was seven prizes out of nine offered, in competition open to all comers, and in which the best choruses of the country were represented. In 1907 Mr. Watkins was induced by Mr. Hallam at Chautauqua Summer School to organize the great chorus in competition consisting of sixty women from the south under Frank Croxton, of Dansville, Kentucky, and fifty-five under M. J. Marquard, the great musical conductor of New York City and fifty-five representing the Western States under J. W. Bird, of Ohio, while Mr. Watkins had a choir of sixty voices drawn from Scranton and vicinity, and even against the tremendous aggregation of highly cultivated and well-trained voices, Mr. Watkins was able to carry off all the honors, taking first place. In 1904 he was made director of the Junger Maennerchor, of Scranton, and has so improved the work of that organization that from the fifth place in the fifth class, its status when he became associated therewith, it has been placed in first place in the first class of the Saengerfest, the Maennerchor, winning a silver cup in the Philadelphia Saengerfest of 1912 for the most finished and artistic singing of the male choruses present at the festival. In 1904 a Ladies' Chorus under his direction was awarded the first prize at Wilkes-Barre, and in July of that year he organized a large chorus for entrance at the contest at the St. Louis Exposition, where his chorus was pitted against the best of this and foreign countries, and where he, as conductor, matched his skill against that of world-famous leaders. Both proved themselves the peers of their opponents, and his chorus won prizes of five thousand dollars, a gold medal, and a diploma, inscribed: "The First Prize for Distinguished Performance in the Choral Contest of the First Grade." But the greatest of his triumphs was consummated at the Pittsburgh International Eisteddfod, in 1913, when the Scranton United Choral Society was given first prize and fifty-five hundred dollars by the adjudicators, and Mr. Watkins was presented with a gold medal in honor of his victory. So great was the enthusiasm and so genuine the delight of the Scranton contingent that Mr. Watkins was raised aloft on the shoulders of his friends and carried from the hall, surrounded by a shouting, applauding multitude of joyful men and women. At the present time (1914) he is considering the organization of a chorus to go to the Panama Exposition at San Francisco, in 1915, to compete against choirs from all parts of the world. Again, on October 6, 1914, Mr. Watkins organized and carried off first honors with six hundred voices from the Elm Park Methodist Church Sunday school. This contest was held

in Scranton's mammoth armory before twelve thousand people, his interpretations were proclaimed by the judges as masterful and convincing. His successes in the musical world read like fairy tales. A record of Mr. Watkins' victories at Eisteddfods and Saengerfests is as follows: Wilkes-Barre Eisteddfod, 1891; Chicago Eisteddfod, 1893; Wilkes-Barre Eisteddfod, 1895; Brooklyn Arion Festival, 1902; Wilkes-Barre, 1904; St. Louis Exposition, 1904; Newark Saengerfest, 1906; Chautauqua, New York, 1907; Madison Square Garden, 1909; Philadelphia, 1912; Pittsburgh International, 1913.

Mr. Watkins confines his fraternal affiliation to the Benevolent and Protective Order of Elks and the Masonic Order, in which latter he belongs to Peter Williamson Lodge, Free and Accepted Masons; Lackawanna Chapter, Royal Arch Masons; Coeur de Lion Commandery, Knights Templar; Keystone Consistory, Sovereign Princes of the Royal Secret; and Irem Temple, Nobles of the Mystic Shrine. He was the director of a quartette composed of members of the local lodge of the Benevolent and Protective Order of Elks.

He married Margaret, daughter of Reese Lloyd, of Scranton. Mrs. Watkins was born in Wales and came to the United States with her parents when four years of age. Her brother was a teacher of Rev. William A. Sunday and did much to induce him to become a revivalist.

To sum up the qualifications that have made Mr. Watkins famous as a choral leader and to explain the constant success that has attended him is to attempt to describe the man himself. He is distinctively temperamental and abounds in dramatic instinct, both cultivated to a high degree, and becomes so thoroughly imbued with the poetry of a selection that he feels each note, rather than hears it. He has acquired the ability so essential to an instructor, of giving those whom he is teaching confidence in their own powers and absolute faith in his judgment. Genial, tactful, and withal a believer in strict discipline, he accomplishes a prodigious amount of work with a chorus, never allowing petty jealousies to flourish or hard feelings to be harbored. A master musician and an artist from the foundation of his nature, the lament of Oliver Wendell Holmes was not for him,

"Alas for those that never sing  
But die with all their music in them."

### JAMES J. LYNCH

Austin Lynch was one of the pioneer settlers in the then village of Olyphant which was part of the old Blakely township, having moved there with his family from Dunmore immediately upon the opening of the coal mines within the limits of what is now the borough of Olyphant. James J. Lynch, son of Austin Lynch, was born June 10, 1845. He obtained a public school education at Dunmore and Olyphant, and when a young man, started in the mercantile business in Olyphant, continuing until his death, January 8, 1898. He was an affable, sympathetic man of pleasing personality with a remarkable memory for names and faces, and had a wide circle of loyal friends. He was an extensive reader, being especially well informed upon historical subjects, current literature and matters of public interest, and his conversational powers made him a delightful companion. He was a firm believer in the value of a liberal education and all his children were given the highest educational advantages. He was a Democrat in politics, although he never took an active part in the affairs of his party, devoting all his time to his extensive business interests. He





*James J. Lynch*

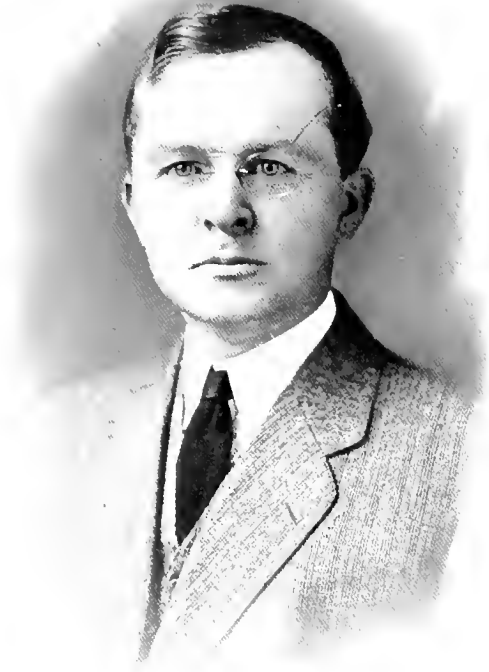

*Frank M. Lynch*

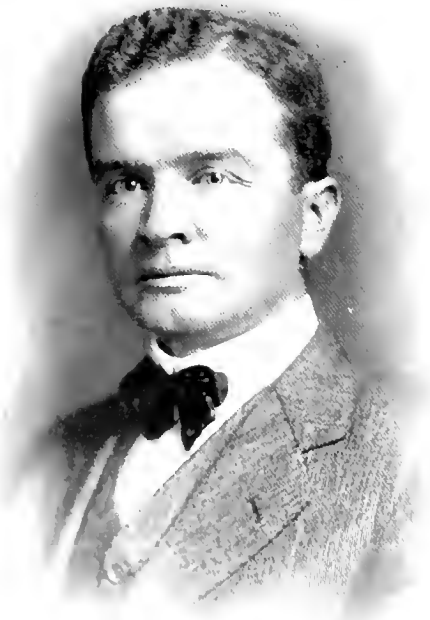

*Bartholomew Lynch*

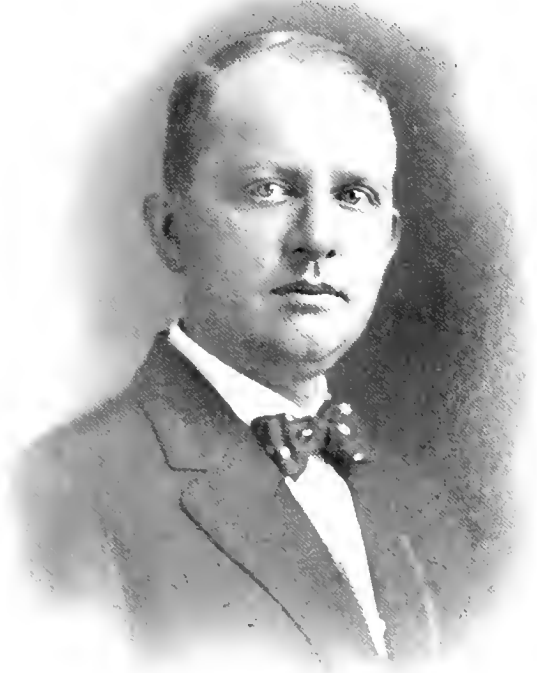

*Austin Lynch*



was one of the first jury commissioners of Lackawanna county, and for a number of years was president of the Blakely poor district. He was not only a successful merchant, but was also interested in many public enterprises as organizer and officer. He was president of the Olyphant Water Company, the Dickson City Water Company, Priceburg Electric Light Company and the Winton Water Company. He won his position and fortune by hard work and wise investments, using rare judgment in his estimate of the value of any proposition placed before him for his consideration. He was a man with an honorable career and left behind him a record of a well spent life. On the 22nd day of February, 1870, he married Mary Elizabeth, daughter of Bartholomew Mooney, and seven of their children grew to mature years: Frank M., of whom further; Bartholomew J., graduated at Millersville State Normal School, was married at Lancaster, Pennsylvania, June 18, 1902, to Gertrude Hershey Miller, daughter of Mrs. Emeline Hershey Miller, of East Petersburg, Pennsylvania, and is now engaged in the real estate business; Leo A., was graduated at Yale College in class of 1899, and at Johns Hopkins Medical College in 1903, was married, October 28, 1911, to Anna Merriman, daughter of Mr. and Mrs. Friend F. Merriman of Dunmore, and is now a practicing physician and surgeon in Brooklyn, New York; Grace M., graduated at Mount St. Vincent's on the Hudson, married Hon. Edward L. Smith, Judge of the Court of Common Pleas of Hartford, Connecticut; Austin (2), educated at Holy Cross College, married, June 27, 1910, Jeanette Kingsley, daughter of Mrs. George Kingsley, of Blakely, and is now an investment broker with offices at Scranton; Stanley and Gerald, were educated at Exeter Academy and Villa Nova College, and now reside at Olyphant with their mother.

---

#### FRANK MARTIN LYNCH

Frank M. Lynch, the oldest son of the late James J. Lynch of Olyphant, was born at Olyphant, May 17, 1874; prepared for college at School of the Lackawanna, Scranton, from which school he entered Yale College in 1893, and was graduated from that institution in the class of 1897. He then entered Yale Law School, but upon his father's death in January, 1898, he remained in Scranton as a law student in the office of O'Brien and Kelly, and on January 23, 1899, upon motion of Joseph O'Brien Esq., was admitted to the bar of Lackawanna county, and began at once a general practice of his profession and is now a successful member of the Lackawanna county bar. In addition to the practice of his profession, he has important business interests. He organized the Olyphant Silk Company in 1905, and is now president of that company; he is also secretary of the Chenango Silk Company of Binghamton, both of which are successful business enterprises. He organized the Dolph Land Company and opened up for development in Olyphant a large tract of land at a time when the growth of Olyphant was materially checked for want of land for new building purposes; he is president of this company and interested in the growth and development of Olyphant. He has always taken an active part in the public affairs of his town, being borough solicitor for a number of years, and it was largely due to his advice and active support that the sewers, pavements and public buildings which are now such a credit to the borough of Olyphant were constructed. On April 25, 1900, he was married in St. Peter's Cathedral Scranton, to Helen, daughter of Mr. and Mrs. Friend F. Merriman of Dunmore; they have the following children: James Merriman, Mary Messenger,

Marjorie Merriman and Frank Martin Jr. He is a member of Scranton Press Club, Scranton Club and Yale Club of New York.

---

#### GEORGE B. SMITH

The name of John B. Smith, father of George B. Smith, is one which has been intimately connected with corporations that have developed the leading resources of the Scranton district from its beginning. He was born in Sullivan county, New York, in 1815, and commenced his active business career in connection with railroad service when he was but fifteen years of age. His first position in this field of industry was under the Delaware & Hudson Canal Company, at Carbondale, Pennsylvania; he was an apprentice in the machine shop of the same road five years; from 1848 to 1850 he was mechanical draughtsman and superintendent of machinery in the Pennsylvania Coal Company; in 1852 or thereabouts was appointed general superintendent of the Pennsylvania Coal Company in Pennsylvania, and filled this responsible position for about half a century; in May, 1886, he was appointed president of the Erie and Wyoming Valley Railroad, which he filled for many years.

George B. Smith, son of John B. Smith, was born in Dunmore, Pennsylvania, and after instruction under private masters entered the Academy of Wyoming, later attending Bisbee's Military Academy, at Poughkeepsie, New York. At an early age he entered the Telegraph Department of the Pennsylvania Coal Company, at Dunmore, after a time being transferred to duty in the office of his father, who was at that time general superintendent of the company. While so engaged he gained a close insight into and familiarity with the affairs of the company, becoming assistant superintendent, a position he held until June 13, 1895, when he was promoted to the general superintendency, holding this place for five years. On June 19, 1900, Mr. Smith was called to the third vice-presidency of the company, continuing in this office until the purchase of the Pennsylvania Coal Company by the Erie Railroad Company, his resignation taking effect, February 28, 1901. During this time he had been treasurer of the Erie & Wyoming Valley Railroad Company, and on May 19, 1896, became superintendent of the company, discharging the duties of this responsible position until he became president, holding that office until February 28, 1901, when the concern was absorbed by the Erie Railroad Company. Mr. Smith is at the present time a director of the Scranton Trust Company, the Scranton Gas and Water Company, the Consumers' Ice Company and the First National Bank, all of Scranton, having assumed his place upon the directorate of the last named institution on April 17, 1897. Mr. Smith's business career has been one useful in the extreme and full of benefit to the companies he served with such signal fidelity, rendered efficient by a large share of native ability. The organizations with which he is identified at the present time are fortunate in possessing him as a director and advisor, his sound judgment and business intuition serving well in council.

Mr. Smith married, February 11, 1886, Grace, daughter of Dr. William A. Durrie Sr., of Brick Church, New Jersey, and they are the parents of two daughters: Louise E. and Florence D.

---

#### STERLING D. PARKER

Son of Rondino Parker and grandson of Sheldon Parker, Sterling D. Parker, of this chronicle, was born at Clarks Green, Pennsylvania. His father is also a native of this place, born in August, 1830, being now eighty-four years of age, his entire life having been passed in agricultural pursuits, in which he has prospered. Rondino Parker married Mary D., daughter of

Ebenezer Slocum, and has children: 1. Jennie D., married Professor Stone, of Cornell University; resides in Ithaca, New York; children: Delia, Mary, Julia, Helen. 2. Thurston S., unmarried, lives on the farm with his father. 3. Sterling D., of whom further. 4. Ward B., a resident of Clarks Summit, Pennsylvania; postmaster and engaged in the real estate business; married Estella Miller; children: Frances, Mary, Ruth. 5. Harold R., married Lucy Barton, and has three children.

Sterling D. Parker, son of Rondino and Mary D. (Slocum) Parker, was born January 15, 1864. He was educated in the public schools of Clarks Green, and after a course in the Keystone Academy attended Easton Business College, of Poughkeepsie, New York, whence he was graduated. After completing his studies he was for five years employed in a grocery store of which an uncle was proprietor, then assumed charge of the general store in Pittston, Pennsylvania, managed by John A. Mears, for the Newton Coal Company. After twelve years in the service of that company, Mr. Parker moved to Scranton and was for two years associated in business with G. J. Barrowman, a grocer of No. 1309 Washburn street, in the time that he was free from this business engaging in insurance dealing. In 1902 he accepted the position of manager of the ordinary department of the Prudential Insurance Company for Northeastern Pennsylvania, continuing in this office in the employ of the Prudential Company to this time (1914). Mr. Parker's work prior to his acceptance of this office was of such a nature as to attract the favorable attention of those in authority in the company, and the offer of his present managerial position was based upon the merit and ability he has displayed in his former capacity. He is a faithful and energetic steward of the interests of his company in the locality over which he has control, giving to its service the best of his talents. Mr. Parker is a member of the Masonic Order, is a director of the Pittston Young Men's Christian Association, and has been a member of the \$100,000 League since its organization. His church is the West Side Presbyterian, and in political belief he is a progressive Republican.

Mr. Parker married Catherine F., daughter of John Barrowman, of Scranton, Pennsylvania. Children: John B., born May 8, 1896; Sterling D. Jr., born July 5, 1911.

---

#### CHARLES B. PARKER

Stephen Parker, the pioneer who founded the line of Parker herein chronicled in Lackawanna county, Pennsylvania, was of Scotch-Irish descent, the family residence having previously been in New England, Rhode Island the locality whence he came. From him the line of descent is through his son, Sheldon, and his grandson, Fernando A., to Charles B. Parker, the present day representative of his line in the city of Scranton, where he is president of the wholesale confectionery firm of C. B. Parker Company, a large and prosperous concern located at No. 36 Lackawanna avenue. Stephen Parker was a farmer in occupation, and after moving to Lackawanna county from Rhode Island settled at Abington. He has children: Sheldon, of whom further; Charles; Stephen.

(II) Sheldon Parker, son of Stephen Parker, was a native of Abington, Pennsylvania, and engaged throughout his active life in agricultural pursuits. He married a Miss Phillips, and had issue: 1. Fernando A., of whom further. 2. Edward R., for many years the proprietor of a general sporting goods store on Spruce street, Scranton, making a specialty of fire-arms; retired from business in 1914; he served in the Union army throughout the four years of

the Civil War, and was engaged in many important conflicts of the war; he married Marion, daughter of Sydney Mears, of Scranton. 3. Rondino, a farmer of Clarks Green, Pennsylvania; married Mary D., daughter of Ebenezer Slocum, and has children, Jennie, Thurston, Sterling, Ward B., Harold. 4. Senora, married W. S. Frace, deceased, and had children, Luella, married Arthur Lemont, chief civil engineer in the mining department of the Delaware, Lackawanna & Western Railroad Company, and Elizabeth, postmistress at Clarks Green, Pennsylvania. 5. Corinthia, married a Mr. Culver and is the mother of a large family. 6. Hulda.

(III) Fernando A. Parker, son of Sheldon Parker, was born in South Abington, Pennsylvania, in 1843, and has made farming his life-long calling. He married (first) Susan, daughter of Jeremiah Hall, (second) Jennie E. Bowen. Children of first marriage: 1. Fred W., lives in California; married Minnie Hapeman and has one daughter, Marion. 2. Carrie, married a Mr. Stone; resides in Arizona; the mother of one son, George. 3. Edward, postmaster at Waverly, Pennsylvania; married Hattie Smith, and has a son Burtis. 4. Charles B., of whom further. Children of second marriage: 5. Leila, married Joseph Challis, an instructor in the Louisburg Normal School. 6. Robert, a salesman in the employ of David Spruks, of Scranton; married a daughter of Rev. Godsall, a Methodist minister of Scranton, and has one son, Robert Jr. 7. Louise. 8. Marian. 9. McKinley. 10. Minnie.

(IV) Charles B. Parker, son of Fernando A. and Susan (Hall) Parker, was born in South Abington, Pennsylvania, May 6, 1868. He was a student in the public schools of Waverly until he was sixteen years of age. Going to Dalton, Pennsylvania, he was there for two years connected with Fred Francis, a lumber merchant, then entered the service of the Lackawanna Iron and Steel Company, of Scranton. Resigning from the employ of this company, he became identified with Price & Howarth, a well-known lumber dealing firm of Scranton, and subsequently formed an association with Jones & Spruks, wholesale produce dealers of the city. Upon the dissolution of this firm, Mr. Parker continued in the service of Mr. Jones, remaining with him for fourteen years, at the expiration of which time he began independent business operations as a wholesale confectioner. The dimensions of his business were at first modest, his establishment being at the corner of Capouse avenue and Marion street, but increasing trade demanded more spacious quarters, so that he moved to a Penn avenue location. This, too, the business outgrew, and for three and one-half years he was located at No. 8 Lackawanna avenue, whence he moved because of insufficient space, this time to No. 32 Lackawanna avenue, where he remained until his five year lease expired, in 1914 occupying his commodious quarters adjoining, at No. 36 Lackawanna avenue. The firm name is now C. B. Parker Company, Mr. Parker and a brother being sole owners of the business, which has been in every way a most gratifying success. Its expansion has far exceeded the most sanguine expectations, as shown by the necessity for such frequent changes of location, the cause of this growth being the earnest labor and intelligently directed effort of the two partners, who have founded a substantial and profitable confectionery trade. Charles B. Parker is a member of Waverly Lodge, Free and Accepted Masons, and belongs to Green Ridge Presbyterian Church. His political belief is independent.

Mr. Parker married Fannie, daughter of J. W. Mershon, of Waverly, Pennsylvania, and resides at No. 1025 Delaware avenue, Scranton, Pennsylvania. Mr. and Mrs. Parker are the parents of: Russell M., born in 1892, a graduate of the Scranton High School, now engaged in business in Carbondale, Pennsylvania; Richard, born in 1897; Ruth, born in 1901.

## JOHN THOMAS DEMPSEY

Organized labor has in the Scranton district, and, indeed, throughout the country, no champion more sincere in word and action than John Thomas Dempsey, president of the First District of United Mine Workers of America. Mr. Dempsey's connection with labor organizations dates back but fifteen years, but in that time he has risen to high position as the representative of the working-men of his locality and has become prominent in other organizations than those of mine workers, on several occasions being delegated to attend the conventions of the American Federation of Labor and once representing that great association in the British Trade Union Congress held in Bath, England.

A native of Scranton, Mr. Dempsey is a member of an Irish family, his father, Patrick Dempsey, having been born in county Mayo, Ireland. Patrick Dempsey came to the United States when a young man and settled in Scranton, following the occupation of miner throughout nearly his entire life, his death occurring in that city in 1900. He married Anna Comerford, of Scranton. Children: James J., a plumber of Scranton, married Belle Gilboy, and is the father of Mary, James, and John; John Thomas, of whom further; Philip, deceased; Mary Elizabeth, married Thomas McDonald; Patrick, deceased; Edward, a plumber, pursuing his trade on the Isthmus of Panama; William, a conductor employed on the Laurel line, married Irene Sexton.

John Thomas Dempsey, son of Patrick and Anna (Comerford) Dempsey, was born May 21, 1877, and until he was eleven years of age was a student in public schools Nos. 4 and 9 in Scranton, also attending the Sisters' School of the Holy Rosary, at Providence. His studies completed, he entered the Fairlawn breaker at Pine Brook, later taking up general mining, and was employed in the Dickson mine, at Green Ridge, the Von Storch mine, the Manville mine, and the Pine Brook mine. He was engaged in the last named mine when he received his election to the position of secretary and treasurer of the First District of the United Mine Workers of America, January 18, 1900, which connection continued until August 1, 1911, when Mr. Dempsey was elected to the presidency of the First District, having for eleven years been closely in touch with all of the interests and activities of the organization through his service as secretary and treasurer for that length of time. This long preparation gave him high qualifications for the office he has since filled so competently, and his steadfast loyalty to the trusts reposed in him as the head of his district has made him an official who has won the regard of his associates. During his term of office Mr. Dempsey has attended all of the district, tri-district, and national conventions of the United Mine Workers of America, and has represented that organization at the Norfolk, Minneapolis, San Francisco, Pittsburgh and Boston conventions of the American Federation of Labor. In 1907 he was chosen as the delegate of the American Federation of Labor to the British Trade Union Congress, which convened at Bath, England.

The benefit of Mr. Dempsey's wide experience in labor organizations and his deep understanding of the conditions governing the relations between the employer and the employee has come to Scranton in his presidency of the Scranton Central Labor Union, an office to which he has twice been elected. His work in behalf of working-men, the bone and sinew of the industrial world, has been such as to win for him their sincere gratitude, and in the adjustment of difficulties existing between capital and labor he has stood forth as the defender of the wronged, gaining for those whom he

represents more equitable relations with their employers and better conditions of employment. Disinterested effort has been the attitude that has won for him admiration and respect. His work has been directed to no selfish end, but has been rendered in the cause of justice and humanity, and through all of his relations with labor unions and organizations he has held up for public inspection a record upon which no blot appears, the sincerity of his purpose and the genuineness of his altruism being apparent to all who have watched his career.

On May 19, 1914, Mr. Dempsey was returned from the primary elections the nominee of the Democratic party for the office of state senator. Should the fall elections place him in the upper branch of the state legislature there will open before him a field of usefulness to which he will come prepared and willing to take up his duties, the force of character and the courage of honest convictions that have characterized his life there, too, serving him well. Mr. Dempsey is a member of the Modern Woodmen of America, and belongs to the Roman Catholic Church of the Nativity.

Mr. Dempsey married, October 11, 1905, Belinda L., daughter of John and Margaret Messett. Children: Edward, Anna, Margaret, Mary.

---

#### JOSEPH A. WADDELL

Descendant of one of the old and prominent families of Virginia, Mr. Waddell, himself of Virginia birth and educated in one of her best technical schools, has passed the greater part of his professional life in Scranton, beginning as designer and salesman, and since 1906 superintendent of the Spencer Heater Company of this city. He is a great-great-grandson of Thomas Waddell, of Scotch-Irish Covenanter parentage, who came to America in 1739. They settled on White Clay creek near the state line in Lancaster county, Pennsylvania. Thomas Waddell, father of the Rev. James Waddell, known all over Virginia as the blind preacher, was born on the Atlantic ocean, his birth-place being the ship on which his parents came over. Rev. James Waddell is the original of the character so graphically portrayed in William Wirt's novel, "Letters of a British Spy." He was a graduate of the old Dickinson College, (Pennsylvania) and a Presbyterian minister. He married Mary Gordon, daughter of Colonel James Gordon, a brave officer of the Revolution. He left issue, among whom, Dr. Addison, of further mention.

Dr. Addison Waddell, son of Rev. James Waddell, the "Blind Preacher," was born in Staunton, Virginia, and there obtained his preparatory and academic education. He attended Princeton College, and later pursued a course at the University of Pennsylvania, there receiving his degree of M. D. After graduating he returned to Staunton and in that prosperous, independent city practiced his profession until his retirement. Staunton, situated in a beautiful, fertile valley, is the seat of Mary Baldwin Seminary, the Virginia Female Institute, Staunton Military Academy, the Western State Hospital for the Insane, and the State Institution for the Deaf, Dumb and Blind. With such of these institutions as existed in his day, Dr. Waddell was connected as physician and also ministered to a large private clientele. He married Catherine Ann Boys, daughter of John Boys, and had issue: Mary Ann; Cornelia, married Rev. Stewart; James Alexander, M. D., a graduate of the University of Pennsylvania, a physician and surgeon of Staunton; John Littleton, a lawyer; Joseph Addison, a lawyer, clerk of the Supreme Court of Virginia for half a century, and state senator; Nathaniel Sylvester; Catherine, married a Mr. Tait; Legh Richmond, of whom further.

Legh Richmond Waddell, youngest son of Dr. Addison Waddell, was

born at Staunton, Virginia, in 1832. After completing his education at Hampden-Sidney College, he became a journalist, a profession he followed most of his life. He was identified with the Staunton Spectator for a time as associate editor, and with other leading newspapers. He retired in later life to his farm, where he died April 19, 1898. He married (first) Belle Hill and had: Lucy, Kitty, Leliah and Belle (twins), Robert, Harry. He married (second) Lilly Mills, daughter of James Mills, of Darby, England. Children: Maude St. Clair, married Marshall L. Walker; Joseph A., of whom further; James Alexander, professor of Pharmacology at University of Virginia; John Atkins; Donald Ellis.

Joseph A. Waddell, son of Legh Richmond and Lilly (Mills) Waddell, was born in Staunton, Virginia, November 5, 1876. He attended the public schools of Charlottesville, Virginia, to which town his parents removed shortly after his birth. He next entered Virginia Polytechnic Institute, where after a few years' course he was graduated in 1900, with the degree of Mechanical Engineer. After graduation he remained at the Institute as instructor in mathematics and experimental engineering, later entering the employ of the Deane Steam Pump Company at Holyoke, Massachusetts. After one year with that company he came to Scranton, Pennsylvania, 1903, as designer and salesman for the Spencer Heater Company, of this city, and after three years in that capacity was made superintendent of the company shops, the important position he now holds. He is a member of the American Society of Mechanical Engineers, American Society for Testing Materials, also the International Society for Testing Materials, and a communicant of the Green Ridge Presbyterian Church. He married (first) Mattie Morton, of Charlotte, Virginia, and had one child by this marriage, Martha. He married (second) Eliza Whittier Little, of Monroe, Michigan, and they had one son, Joseph Addison.

---

### JASPER C. TAYLOR

The Taylors have long been residents in the Scranton district. Reuben Taylor, the great-grandfather of Jasper C. Taylor, of this narrative, settled in that locality in 1783. The Taylors were previously residents of Connecticut and came to Pennsylvania with other Connecticut settlers to hold the land as against those claiming title under William Penn.

(I) Reuben Taylor fought in the American army in the War for Independence, and after the victory of the Colonial cause bought an extensive tract of land in Providence township, property later known as the Joseph Griffin farm. He became a partner in the ownership of a mill erected on Roaring Brook by Phillip Abbott. Mr. Abbott built the first house in Deep Hollow, afterward known as Slocum Hollow, and was the owner of the second house raised in that place. About 1816 Mr. Taylor disposed of the Joseph Griffin farm and his interest in the mill, and moved to Greenfield township, where he bought five hundred acres of land. This tract was covered with heavy timber, and had to be cleared before it could be plowed and planted. But it was very fertile, and under Mr. Taylor's vigorous attack, agricultural operations were soon under way. He was the father of John A., of whom further, Noah, Daniel, Thaddeus. Reuben Taylor died in 1849, and was buried in the little cemetery on the hill above Montdale.

(II) John A. Taylor, son of Reuben Taylor, was born in Providence township, Luzerne (now Lackawanna) county, Pennsylvania, about 1790, and died in 1867. He married Gartry Ackley, and had thirteen children, one of whom died in infancy, those surviving being as follows: Stephen A., born in 1812; Truman A., 1814; Charlotte A., 1816; Silas A., 1818; Cynthia, 1820;

John Milton, 1823; Celenda, 1825; Charles C., of whom further; Henry, 1829; Draper U., 1831; Helen, 1833; Benira, 1836.

(III) Charles C. Taylor, son of John A. and Gartry (Ackley) Taylor, was born in Greenfield township, Luzerne (now Lackawanna) county, Pennsylvania, April 17, 1827. He was educated in the public schools, and throughout his entire life followed farming as his occupation, meeting with good success in the tilling of the soil. He married Lucy A., daughter of Benoni Stone, of Greenfield township. Benoni Stone was of English descent and came to Pennsylvania from Rhode Island about 1820, his death occurring in Scott township when he had attained the unusual age of ninety-three years. Charles C. and Lucy A. (Stone) Taylor had five children of whom Jasper C., of whom further, and Maud, who married James N. McLaughlin, are now living.

(IV) Jasper C. Taylor, son of Charles C. and Lucy A. (Stone) Taylor, was born in Scott township, Luzerne (now Lackawanna) county, Pennsylvania, January 17, 1857. His early education was obtained in the public schools of Scott township. Later he was successively a student in Madison Academy at Waverly, Wyoming Seminary at Kingston, and Keystone Academy at Factoryville. In these institutions he was fortunate in coming under the personal influence of three able educators, Professor Harvey D. Walker, Dr. David Copeland, and Dr. John H. Harris, now president of Bucknell University. While a student in these institutions, Mr. Taylor taught four winter terms in the rural schools of Scott and Greenfield townships, and had an excellent opportunity to study human nature while "boarding round" among his patrons. The salary was eighteen dollars per month. In 1881 Mr. Taylor was graduated from Mansfield State Normal School and later took a special course in Cornell University. After graduation he served successively as principal of the high schools of South Abington, Jermyn, Milford (Pike county), and Providence (Scranton), and in the last position served seven years. In 1893 he was elected county superintendent of schools for Lackawanna county, which position he still holds, having been re-elected seven times, the last two terms without opposition. Mr. Taylor probably owes his continued re-election to two characteristics: First, he is an ardent advocate of the public schools, and gives his whole time to their improvement. Second, in granting certificates or in placing teachers he is absolutely impartial. Republicans and Democrats, Catholics and Protestants, receive the same treatment.

The central doctrine of Mr. Taylor's policy is that teachers must be trained for their work. In 1893, when he began his work, there were thirteen trained teachers (normal school graduates) in his territory. Now there are three hundred and eleven normal school graduates in the same territory and only twenty-three under his supervision teaching on low grade or provisional certificates. Soon all schools will be taught by trained teachers. Many modern improvements have been introduced into the schools. Nearly all of the rural schools are furnished with modern heating and ventilating plants, slate black boards, and a variety of maps, charts, globes, and other necessary apparatus. Agriculture is taught in all rural schools. Free movement writing was introduced in 1909, and State Superintendent Schaeffer says the penmanship in Lackawanna county is superior to that of any other county in the state. Mr. Taylor is the author of the Directors Association Law, which requires the school directors of each county in the state to meet annually in their respective counties for the discussion of educational problems. Mr. Taylor has been prominent in state educational meetings, and has served as president of the department of county superintendents.







Gustav Kautlin.

In national politics Mr. Taylor has usually supported the Republican party, but in local affairs he is independent, trying to vote for the most competent candidate. For the last fifteen years he has attended the Green Ridge Presbyterian Church, but is liberal in his views, believing that conduct is the test of character, and that all will be saved who live according to the mandates of conscience, without regard to church affiliation. Mr. Taylor is a member of the New England Society of Northeastern Pennsylvania, of the Independent Order of Odd Fellows, (since 1889), of the Green Ridge Lodge, Free and Accepted Masons, and of the Patriotic Order Sons of America.

In 1879 Mr. Taylor married Ruth Ella Cobb, of Lenoxville, Susquehanna county, Pennsylvania. Three sons are the result of this union: 1. Verne E., born in 1880; educated in Scranton High School, Pennsylvania State College, and Pratt Institute, where he was graduated in the course of Electrical Engineering in 1905. 2. Earl M., born in 1882; a graduate of Scranton High School, and of Cornell University, taking his A. B. degree in 1907. 3. Otto D., born in 1894; educated in Scranton High School and Cornell University.

---

#### GEORGE HENRY CATLIN

George Henry Catlin was born in Shoreham, Vermont, August 26, 1845. He was educated at Newton Academy, Shoreham; at Vermont Episcopal Institute, Rock Point, near Burlington, Vermont; and Phillips Academy, Andover, Massachusetts. He studied law and the degree of LL.B. was conferred upon him in 1866 by Union College and the degree of M. A. by Lafayette College in 1867. Mr. Catlin was admitted to the bar at Albany, New York, and for two years practiced law as the junior member of the firm of Pope, Thompson & Catlin, No. 17 Nassau street, New York City. In 1870 Mr. Catlin came to Scranton, and has been a prominent figure in its financial life since that time. He was one of the organizers of the Third National Bank of Scranton; was its first vice-president, which office he filled continuously and with efficiency for more than twenty-five years. He was a director of the Scranton Savings Bank for many years until its consolidation with the now Savings and Dime Bank. He has been a director of the Scranton Street Railway; of the Erie and Wyoming Valley Railroad; and for seventeen years has served on the board of directors of the Crown Point Iron Company of Crown Point, New York. Mr. Catlin is a Presbyterian; has for forty years been a member of the First Presbyterian Church of Scranton, and has been honored with a place upon its board of trustees. In his political affiliations Mr. Catlin has been a staunch Republican, an ardent admirer of the principles and traditions of Abraham Lincoln.

Mr. Catlin married (first) September 4, 1867, Mary Woodrow Archbald, a daughter of James Archbald Sr., then chief engineer of the Lackawanna Railroad. There were no children born to them. Mrs. Catlin passed away in 1902. On January 10, 1904, Mr. Catlin married (second) Helen Walsh, of Carbondale. There have been no children born of this marriage. He still retains and enjoys the old "Belle Meade farm," of one hundred and twenty-five acres in Vermont, which has been in his family four generations. Mr. Catlin has preserved the memories of his parents and deceased wife by beautiful memorial windows in the old church of his native town, Shoreham, Vermont. Although now on the borderland of the allotted period of "three score years and ten," Mr. Catlin is still vigorous in mind and body and active in business. He has a large and extended acquaintance, and is justly popular with his associates.

## HARRY M. SIEGEL

The following record of business achievement that cannot but excite the respect and admiration of the reader is a tale that tells of opportunity seized, of courage, zeal and perseverance at work, and of success gained. It is a story that, in greater or in less degree, has many counterparts, and that is the biography of Harry M. Siegel.

Born of Jewish parents, and coming to this country from Russia with his parents, while a boy, on August 8, 1893, he entered the public schools. A year later he was compelled to rely on his own resources on account of the death of his mother, and was forced to earn his own living. He began his career as a newsboy. In the year of 1900 he saw the possibilities in a lunch room then situated at 221-23 North Washington avenue, and through the savings acquired by the sale of the newspapers he purchased the lunch business from the late E. Moses, and it is well to mention here that the price paid for the said lunch business was \$500.00 out of his entire capital of 504.63, thus leaving Mr. Siegel with the sum of \$4.63 to conduct a business which was new to him. Through his hard efforts he made his lunch house the most popular in the city of Scranton, and during the time the lunch room was under his management the returns were most gratifying. In 1907 Mr. Siegel saw the possibilities in the real estate business in the city, and he gave up the lunch business for the real estate business, and commenced operations in a small way under the name of Siegel's Realty Company, and to this day the firm handles probably more down-town real estate than all other concerns in this line in the city, not only for others, but for himself as well, and from this he has acquired large returns. Mr. Siegel has made the force of his personality felt in each line in the city of Scranton, and in each has placed himself among the leaders solely and simply upon his merits. His aspirations have ever been high, but in attaining their height he has not scorned the value of things of lesser brilliance nor has considered his abilities too great for small employment. His pride has been only that justifiable feeling of gratification at a task accomplished, and has never caused him to regard appearances if his duty was plain and honorable. So, from affairs of little moment, he has advanced until his operations have assumed both importance and magnitude, knowing that he has prepared himself for these greater things by conscientious mastery of those to which there seemed to be but little consequence attached. He has achieved through a spirit of progress, through strong perseverance, through persistent courage, through self-reliance and ability, and to him nothing but credit can be rendered, for, far from being favored at the start of his career, he was handicapped by the necessity of acquiring a new language and of learning new customs. Now of youthful years, he has performed what many men fall short of in a lifetime, and having tested his steel in battle, should advance to further conquest.

---

CHRISTOPHER G. BOLAND

Among the most active and progressive business men of Scranton is C. G. Boland, who is a most prominent representative of the underwriting fraternity, and has long enjoyed the fullest confidence and consideration of a wide circle of clients. He entered the insurance business in 1881, having succeeded to the old Lackawanna Insurance Agency, at that time conducted by the late I. L. Post Esq. The Agency transacts a general insurance business, and the list of companies represented includes such high-class organizations as are veritable rocks of stability and to the firm's credit it may be said that during its



*Arvid Sigel*



entire history every just claim has been promptly adjusted. Mr. Boland is an experienced underwriter and an enterprising business man who has acquired his present enviable position in the business world through unremitting labor, and during his career as a citizen of Scranton he has occupied several important public positions. He resides at No. 411 Monroe avenue. His office is located at 229 North Washington avenue.

Mr. Boland was born in December, 1855, son of James and Anna (Biglin) Boland. In his boyhood he worked on the construction of the Delaware & Hudson Railroad between Scranton and Wilkes-Barre. His education was obtained in the public schools and Gardner's Business College. His first business experience was as a clerk and bookkeeper in the mercantile trade. In 1878 he entered into partnership with his uncle, the late W. R. Boland. During the last mentioned year he was elected to the Board of School Control and served as secretary of that body. He also served as deputy recorder of deeds under A. M. Renshaw, the first recorder of Lackawanna county. In 1880 he was appointed special agent of the census department on manufacturers in the Lackawanna district. In 1888 he was re-elected to the Board of School Control, during his term a system of free text-books was established and equal pay to male and female teachers inaugurated. Both of these measures received his unqualified support. He has been prominently identified with board of trade affairs and has personally aided in promoting many of the diversified manufacturing interests which have contributed so largely to the growth and progress of Scranton. Notwithstanding his busy life he is ever ready and willing to lend his effort and time in matters of a public nature which may redound to the benefit of the community. He stands in the front rank of the business men of the city. Mr. Boland has been president of the Lackawanna National Bank of Lackawanna since 1904 and has met with gratifying success. In 1910 his business was incorporated under the name of the C. G. Boland Company. In politics Mr. Boland has always been a Democrat and an ardent worker in every sense of the word. He is a member of several fraternal organizations, among which may be mentioned the Scranton Lodge, Benevolent Protective Order of Elks; Improved Order of Heptasophs; Royal Arcanum; Maccabees; C. M. B. A. and C. T. A. societies.

Mr. Boland married, November 23, 1881, Mary E., daughter of the late Bernard O'Malley Esq., of Scranton. Children: Anna, married Dr. A. W. O'Malley; James J., vice-president of the C. G. Boland Company; Alice, supervisor of sewing in Scranton public schools; Helen, Rosa, Christopher G. Jr., Kathleen, Joseph.

---

#### BENJAMIN S. WAKEMAN

Although he with whom this chronicle deals owns the state of New York as his birthplace, Pennsylvania is nevertheless the home of the family, and in that state the father of Benjamin S. Wakeman, the Hon. Seth Wakeman, was born, at Pembroke, in 1806. His later career deserves more careful consideration than the outline that can be given here, for the story of his rise from the estate of a shoemaker to the heights of legal fame commands the closest attention and arouses the highest respect. The fact of his wonderful advance is the more unusual when it is recalled that the privilege of a college education under scientific training was denied him and that most of the wide knowledge of legal matters of which he became the possessor was acquired in spare hours, most of his time being spent over the work bench. Like so many of the men who have filled our history with the best of its pages, he thrived on adversity, and the fact that so many of

the advantages of life were withheld from him only made him the more eager to make them his. Even after his admission to the bar he still continued work at his trade, and did so until the demands of a growing practice compelled him to lay aside the awl and the hammer and to devote his whole time and attention to the profession to which he had gained admission by so difficult a route. He made a specialty of criminal cases and became known as one of the most efficient lawyers in that difficult branch of the legal procedure of the day. Thorough and accurate in his preparation of a defence, his presentation displayed to the full the forensic gifts with which he had been endowed, and many are the unfortunate victims of circumstance who owe their reinstatement to society and the opportunity for a fresh start in life to the talents that had been so prodigally bestowed upon Mr. Wakeman. In the imparting of the legal lore he had learned under a depressing handicap he was remarkably skilled, and of those who listened at his feet and reaped the benefit of his years of experience and unceasing study were several who afterward aspired successfully to the pinnacle he had attained and held for many years. As was but natural to one of his standing, politics claimed his services and he was elected to Congress in 1872. In this body his previous record and the maturity of his judgment, he being at that time sixty-six years of age, lent weight and influence to his counsel even among that august number of statesmen, and to a career of continuous legal success he added the brilliance of political prominence, rounding out a life of vigor and activity, zealously spent in the pursuit of his profession.

Mr. Wakeman married Laura Winans. Children of Seth and Laura Wakeman: Emma, married ———— Garrett, the present editor of the Batavia (New York) Daily News; Benjamin S., of whom further; and W. S., a photographer of Batavia, New York.

Benjamin S. Wakeman, eldest son and second child of Seth and Laura (Winans) Wakeman, was born in Batavia, New York, May 3, 1862. His father realizing the value of scholastic training from his own lack of educational opportunity, after his preliminary attendance at the public schools, Mr. Wakeman was enrolled at the Oakfield Seminary, later attending the Mount Pleasant Military Academy. His first venture in the business world was as a manufacturer of novelties, an enterprise which he soon abandoned, coming to Scranton and there engaging in the hotel business, a line of activity that has ever since claimed him. In 1911 he became the proprietor of the Hotel Schadt, a house of entertainment erected in 1900, and still continues as the popular and well-liked head of that house. Genial and affable, his unceasing devotion to the wants of his patrons has brought to the hotel many guests, all of whom are the recipients of his gracious hospitality. Mr. Wakeman is a supporter of the Republican party in all political matters, and affiliates with the Fraternal Order of Eagles. Mr. Wakeman married Margaret Teyden.

---

#### CHARLES SEABERT ROSS

Someone has said that the successful man is the one who so conducts his life that when his influence is removed from the community the constructive up-lifting forces suffer a distinct loss. Charles S. Ross, assistant cashier of the Traders National Bank, has not only won for himself a place of considerable responsibility and trust in the business community, but he is also taking an active interest in the social, religious and other activities that tend to make Scranton a better place to live in. Mr. Ross possesses an exceedingly pleasing



personality, and this, coupled with his frank, open manner and a sense of honor and justice that has been developed to an unusual degree, has drawn around him a wide circle of friends from all stations and walks of life. After a cordial, courteous greeting at his hands one instinctively feels that he has met a real gentleman.

J. Elliot Ross, father of Charles S. Ross, was born in England in 1847. When he was five years of age his parents immigrated to America, settling in Schuylkill county, Pennsylvania. J. Elliot Ross received his preliminary education in Bellefonte Academy and later graduated from Lafayette College. In 1875 he married Frances Hall, daughter of Rev. O. L. Hall, a chaplain in the Union army during the Civil War. After teaching for several years in the Scranton public schools, Mr. Ross was admitted to the Lackawanna county bar in 1884 and practiced law in this city until his death in 1905.

J. Elliot and Frances (Hall) Ross were parents of four children: Frances Mabel, married to H. R. Kingsley, and living in Scranton, the parents of one son, Robert Elliot; Charles S.; Lelia Edna; Jay Elliot married to Jessie M. Moffat.

Charles S. Ross was born at Shickshinny, Pennsylvania, September 16, 1878. He obtained his early education in the public school and high school of Dunmore, Pennsylvania. After finishing his studies he entered the employ of the Hillside Coal and Iron Company and after five years service with this company became a bookkeeper in the Traders' National Bank of Scranton. His connection with this institution began in 1903 and he later filled the positions of receiving teller, paying teller, and in 1912 was promoted to the position of assistant cashier. These promotions came to Mr. Ross only after hard and conscientious work on his part had demonstrated that he possessed the qualifications and capabilities that justified them. But the eleven years he has been identified with the Traders' National Bank have proven beyond doubt that the financial field is the one for which he is eminently fitted. His fidelity to the principles of absolute justice and honest service have won him the respect and esteem of all who know him.

Mr. Ross is an active member of the Green Ridge Presbyterian Church, having served three terms as superintendent of the Sunday school. He is also a member of Peter Williamson Lodge, No. 323, F. and A. M., Coeur de Lion Commandery, No. 17, K. T., and is a veteran of the Spanish-American War, belonging to the General J. P. S. Goban Camp, of this city.

On October 20, 1903, Mr. Ross married Mary Grace Burns, daughter of I. H. Burns, of Scranton, and together they preside over a happy little home at 1731 Capouse avenue. They have been blessed with two children, Charles S. Jr., born June 30, 1907, and Donald Burns, born October 28, 1911.

---

#### HARRY A. CONNELL

One of those energetic and sagacious business men whose presence in any community imparts a healthy impetus to the current of all business affairs is to be found in the person of Harry A. Connell, of No. 1021 Vine street, Scranton, Pennsylvania. Modest and unassuming, he is entirely unconscious of the salutary influence he exerts in the community, has not thought of being regarded as an exemplar, and merely so acts his part in life as to have the approval of his own conscience.

Harry A. Connell was born in Minooka, Lackawanna county, Pennsylvania, September 10, 1860. He received a thorough education in private schools in Scranton, and upon the completion of his studies established himself in the jewelry business, under the firm name of Mercereau & Connell.

After a time Mr. Connell bought out his partner's interests, and conducted the business under the name of H. A. Connell, until 1911, very successfully. He then became purchasing agent for the Coal Land Security Company, the Green Ridge Coal Company, the Enterprise Coal Company, the Lackawanna Coal and Lumber Company, and the Paint Creek Colliery Company. His religious affiliation is with the Methodist church, and he is prominent in the Masonic fraternity, in which he has attained the thirty-second degree. He is also a member of the Scranton and Country clubs.

Mr. Connell married Annie Jay, a native of Scranton, and a daughter of Douglas Jay, of that city. They have children: Harold E., married, has three children, and lives in Scranton; Helen, married Charles Cheney, of Elizabeth, New Jersey, and has one child; Louise and Douglass J., at home.

---

#### JACOB BYRON SNYDER

Jacob Byron Snyder, who was active in legal circles and public life in general in Scranton, Pennsylvania, for many years, was born in Greenfield township, Luzerne (now Lackawanna) county, July 7, 1824, and was a son of Jacob and Rebecca (Niver) Snyder, and a grandson of Jacob Niver. The ancestors on both sides were of Dutch descent, and Mr. Snyder and Mr. Niver participated actively in the war of the Revolution. The public schools furnished a sound and practical preparation for his legal studies, which Mr. Snyder took up with F. M. Crane and Earl Wheeler at Honesdale, and with W. G. Ward at Scranton. For some years Mr. Snyder was a resident of Wayne county, Pennsylvania, and while there served as justice of the peace for a period of ten years, and as coroner for a term of three years. After taking up his residence in Scranton, he was appointed as court crier of Lackawanna county, and served many years. Mr. Snyder married, June 20, 1850, Elizabeth, a daughter of John Decker, and of their children: Byron Jacob, married Matilda, daughter of Lewis Cramer; Samuel Henry; Fred Gunster.

---

#### WILLIAM J. COSTELLO

Born in Dunmore, all of his fifty-seven years passed in that place, fifty-five of them in one place, William J. Costello is now one of the flourishing, prosperous merchants of that borough whose fortunes have increased with the growth of Dunmore and whose success has been brought by advancement of the industrial possibilities of that borough.

He is the youngest of the four children of Thomas and Ellen Costello, two of whom were sons and two daughters, and was born in Dunmore, Lackawanna county, Pennsylvania, August 31, 1856. He was reared in the place of his birth, and after finishing his studies in the public schools obtained employment in the neighboring coal mines. Afterwards he left mine service and in 1876 became a clerk in No. 6 brick store for J. Scott Inglis, on April 1, 1887, establishing on his own responsibility in the same line, general merchandise. This has since been his occupation, and the residents of the borough of his birth have been generous in their patronage of his store, favoring him with a large and lucrative trade, to whose needs and wants he has attended in a manner thorough, honorable and business-like. Mr. Costello has long been a stockholder and is now a director of the First National Bank, of Dunmore, and as a Democrat for six years held membership on the school board, now serving on the board of auditors of Scranton and Dunmore poor district. He is a member of Ancient Order of Hibernians, Division No. 33, and belongs to St. Mary's Roman Catholic Church.

Mr. Costello married Margaret, daughter of John Duffy, her father a contractor, being employed in the construction of the Gravity Railroad, "Duffy Cut" bearing his name. They were the parents of a son, Frank, who died in October, 1908, aged twenty years, having but a short time previous graduated from St. Thomas College, class of 1907, and at time of his death was a student in Georgetown University.

---

### JOHN FLANNERY

County Mayo, Ireland, for many generations has been the home of the Flannery family, the Scranton representative of which is John Flannery, for more than half a century a resident of this city, whither he was brought in infancy. His father, John Flannery, was born in county Mayo, Ireland, in 1807, and there grew to maturity, crossing the ocean to the American continent in the year that the plague was prevalent in Quebec, Canada, 1844, and for several years was a member of the police force of the Canadian capital. Crossing the border into the United States he continued his travels, remaining for a time in New York, later moving to Hawley, Pennsylvania, from which place as a center of operations, the construction of the Lehigh section of the Delaware, Lackawanna & Western Railroad, were being directed. He obtained employment with the force working thereon, and in 1863 met an accidental death while working on that portion of the road between Moscow and Lehigh. He married Nora Flannery, and had children: 1. Edward. 2. Thomas, a resident of San Antonio, where he is superintendent of the city water system; he is the father of: Edward, a government inspector of the fortifications at El Paso, Texas; Thomas, Robert, William, Ella, Bessie, Mary, Ann. 3. John, of whom further.

John (2) Flannery, son of John (1) and Nora (Flannery) Flannery, was born in Lehigh, Lackawanna county, Pennsylvania, July 10, 1863, and was a mere infant when his parents brought him to Scranton, his father's death occurring soon after. He began his education in the public schools of that city, finishing his studies at St. Cecelia's Academy, leaving school when he was thirteen years of age to accept a position in a grocery store. His ambition won him advancement and he became the proprietor of a store of like nature and until 1900 conducted general grocery dealings at No. 152 Seventh street. In that year he opened a cafe at No. 701 Scranton avenue which is in prosperous operation at the present time. For sixteen years Mr. Flannery has been a member of Holy Cross Parish, and he belongs to the Catholic Mutual Beneficial Association, the Knights of St. George, and to Aerie No. 314, F. O. E., in which he has held membership for eighteen years.

Mr. Flannery married Ellen, daughter of Patrick Sammon, of Dunmore, and his three children: Nora, Margaret and John, are all students at St. Cecelia's Academy, of Scranton.

---

### WILLIAM J. SCHOONOVER

Originally Von Schoonover, this old Holland family first appears in Wayne county, Pennsylvania, about 1791. William Schoonover, the first settler, arrived from New Jersey, and a tract of four hundred acres was surveyed on a warrant dated March 12, 1803, and a patent was issued to him January 27, 1804, in which it was called "Monmouth" and described as containing four hundred and thirty-nine acres and thirty-nine perches. After having undisturbed possession for ten years, other parties attempted to effect

his removal from the tract, on the claim that he was infringing on their rights, claiming prior ownership. Jason Torrey, the surveyor, soon discovered that the Schoonover title was good, and in consideration of one-half the tract he perfected the title and established ownership, obtaining patent on date as stated. He took the southern part of the tract and on it was later built the now borough of Honesdale, the terminus of the Delaware and Hudson Canal. William Schoonover had built a log cabin on his tract and began clearing a farm. It was slow work and in 1804 he had cleared but eight acres; he owned two horses and two cows, his entire property being valued at \$411. With the building of the canal and founding of Honesdale, values increased and the farm became valuable property.

A descendant of William Schoonover, the first settler is William J. Schoonover, founder of the W. J. Schoonover Glass Company, son of Charles K. and Roxana Ann (Brown) Schoonover. Charles K. Schoonover was born in Wayne county and was a farmer until a few years ago, when he moved to the borough of Honesdale. He married Rosanna Ann, daughter of George W. Brown, of Smith Hill, Wayne county, Pennsylvania.

William J. Schoonover, only child, was born at Bethany, Pennsylvania, June 1, 1880. He was educated in the Honesdale High School and Scranton Business College, taking a course at the latter institution after he had left the home farm many years. While attending school he also worked in the printing office of the Wayne Independent. At age of thirteen years he left the home farm, worked at various employments, and in 1900 came to Scranton. He there increased his store of knowledge by a course in a business college, and gained a good understanding of matters in which he had felt himself deficient. He became a glass salesman and in 1906 was employed as traveling representative by a Philadelphia house. In 1910 he was married and the same year began business for himself. He began business in August, 1910, as the W. J. Schoonover Glass Company, starting in a modest way on West Lackawanna avenue with one employee, making mirrors, being the first successful manufacturers of mirrors in the city. As prosperity came he moved to enlarged quarters, No. 823 Wyoming avenue, where ten people are now employed. He also is a jobber of glass, being the only jobber of plate glass in his territory—Northeastern Pennsylvania. He has also established a department for grinding, beveling and polishing plate glass, this being now an important part of his business and the only plant of its kind in this part of the state. Mr. Schoonover has worked his way upward to his present prosperous business by close attention and good methods, untiring industry and splendid courage. He believes in his own powers and does not hesitate to take a forward step. As the best years of life are before him, with his feet firmly planted on the rounds of the ladder of success, he surely will continue upward. He is a member of the Masonic Order of high standing, belonging to Green Ridge Lodge, Free and Accepted Masons, and to all the bodies of Keystone Consistory, Ancient Accepted Scottish Rite, in which he has attained the thirty-second degree. He is also a Noble of Irem Temple, Nobles of the Mystic Shrine. In politics he is an Independent, and in religious faith a member of Green Ridge Baptist Church.

Mr. Schoonover married, in 1910, Alameda G., daughter of Charles H. Smith, of Seelyville, Pennsylvania, she a communicant of Honesdale Presbyterian Church.



*M. J. Schoonover*



## CITY OF SCRANTON

### CHARLES B. PENMAN

During the closing chapter of his life Charles B. Penman, for half a century a resident of the city of Scranton, was associated with the Department of Internal Affairs of the State of Pennsylvania as chief of the Bureau of Industrial Statistics. He was called to important duties in studying and recording the condition of the commonwealth's industries and activities from a position of political and public prominence in Scranton, where, as at the state capital, his many excellent qualities of manhood and friendship won the appreciation and regard of his colleagues.

The family of Penman is of Scotch derivation, and is well represented in the Scranton district, James Penman, father of Charles B., having had a numerous family, of whom the following are residents of Scranton: Major T. Frank, at one time connected with the government service as internal revenue collector; David, Robert, Elizabeth, Mary.

Charles B. Penman, son of James Penman, was born at Port Carbon, Pennsylvania, and obtained his general education in the Scranton schools, including a high school course, and afterward qualified as an expert accountant. His business life was passed in Scranton, and there he lived until his appointment as chief of the Bureau of Industrial Statistics in the Department of Internal Affairs of the State, an office he filled for ten years with the utmost satisfaction. He came to the bewildering duties of chief statistician with a mind accustomed to mazes of facts and figures from his work as expert accountant, and introduced into his office methods and systems that greatly simplified the gigantic task of tabulating the industrial resources and achievements of so rich and industrially powerful a state as Pennsylvania. Confidence and competence were his ruling attributes, the former born of the latter after a thorough and vigorous test of his qualifications for his office, which found in him all that could be desired.

An attractive personality and an agreeable nature made Mr. Penman a social favorite, and being an easy conversationalist and a lover of the company of his fellows, social gatherings likewise held for him a charm. His wide acquaintance found him ever a man of unpretentious aspect, sincere in word and manner, willing to serve a friend at any lengths. In matters of public and political interest he was well-informed, and while a resident of Scranton his services were invariably sought as a tabulator of the election returns from the county, a position he filled with annual regularity, year after year registering the fates of aspiring candidates and announcing them to his fellow citizens. The duties of the office in which he died made necessary long absences from his home city, his many friends regretting the loss of so congenial a companion. His political creed was Republican, and he was a member of the Masonic Order, Peter Williamson Lodge, Free and Accepted Masons.

Mr. Penman married Harriet Clay, born in Lackawanna county, Pennsylvania, a woman of education and wide culture. She is prominently connected with journalistic work, contributing to numerous magazines and newspapers, and is society editor and editorial writer on the Scranton Tribune Republican. Mrs. Penman is a member of the Central and Country clubs and was the leader of the movement which culminated in the employment of a district nurse, being also associated with numerous benevolent, philanthropic and educational enterprises tending toward civic and moral uplift. Since the death of her husband, which occurred November 11, 1912, Mrs. Penman has continued her residence at her former home, No. 526 Quincy avenue, Scranton.

## PATRICK J. CLARK

With the exception of a short time passed in the northwestern part of the United States, the whole of Patrick J. Clark's American residence has been in the borough of Dunmore, Lackawanna county, Pennsylvania, where he now lives. He is a native of county Mayo, Ireland, his father, James Clark, also born in Ireland. James Clark followed the blacksmith's trade throughout his active life, his death occurring in the homeland when he was about seventy-five years of age. He married Catherine Forbes, born in Ireland, died in Dunmore, Pennsylvania, aged eighty years, buried in St. Mary's Cemetery, of that place. Children of James and Catherine (Forbes) Clark: John, deceased; Michael; James, deceased; Mary, deceased; Bridget; Helen, deceased; Dudley, deceased; Patrick J., of whom further; Margaret; Catherine.

Patrick J. Clark was born March 13, 1849, and when a youth came to the United States. He was a small boy when he began to work in the mines at Dunmore, later obtaining employment in a blacksmith's shop, where he remained until 1876. Becoming a worker in iron, he entered the service of the Scranton Bolt and Nut Company, and was connected with this concern until his retirement, in September, 1913. He is a member of St. Mary's Roman Catholic Church, and politically is a strong Democratic sympathizer, having at one time been elected to the Dunmore borough council as the candidate of that party.

Mr. Clark married, in Dunmore, Pennsylvania, Anna Donough, a native of Ireland, who came to the United States in girlhood. Of their thirteen children the following grew to maturity: James J., deceased; Anthony, Joseph L., Frank D., Catherine, Cecelia, Anna, Nellie E., Genevieve. Mrs. Clark died January 14, 1894, aged forty years, and is buried in St. Mary's Cemetery.

## DUNCAN T. CAMPBELL

There is no name that calls more readily to mind the thrilling days of border warfare in old Scotland and the brave and daring exploits of the Scotch clans than that of Campbell. The mention of the name raises visions of gallant chieftains leading their small bands over Scotland's lofty crags and down into her river-run valleys in search of vengeance for private wrongs or in defence of national honor. The deeds of the Campbells fill many pages of Scottish history and reveal a clan loyal to their king, and strong in his defense. In private life their characters show indomitable courage in the face of adversity, loyalty to home and family, and a determination that no circumstances can dishearten or overwhelm. From such pure Scotch ancestry, traced back through many generations, comes Duncan T., son of Alexander and Helen (Turner) Campbell.

Duncan T. Campbell was born in Glasgow, Scotland, December 7, 1875. His early education was obtained in the public schools of the city of his birth and it was there that he held his first position, in the office of a company engaged in the East India mercantile trade. He there remained until 1896, when the desire for new scenes and action, inherited from forefathers, who had but to raise their voices in a battle cry to be in the midst of the most exciting action, becoming strong within him, he left the land of his birth and embarked for the United States, the country whose shores have ever promised opportunity to the ambitious youth of other lands and whose letters have always spelled success in innumerable languages and dialects. The promise that had sounded across the Atlantic to the ambitious Scotchman was not immediately fulfilled, as for several years he was engaged in business in New



York City with moderate but not satisfactory success. His health becoming impaired by the close and undivided attention he has always given to his business and the task at hand, he left the metropolis and endeavored to recruit his failing strength in the bracing mountain air and health-giving climate of Colorado. While there he began a connection with an electric company, which in experience and training has proved very valuable to him in his present responsible position. In 1907 his physical condition had so improved that he was able to stand the less favorable conditions of the eastern part of the country, and accepted a position as business manager of the Scranton Electric Company, an organization subsidiary to the American Gas and Electric Company, which controls a large number of similar plants in different parts of the United States. This office he filled with great satisfaction to the officers of the company and with decided benefit to the business, which he systematized minutely and placed upon a smooth working basis. In recognition of his excellent service in that capacity he was made general manager of the company where he gained quite as much distinction as he had in his former office, inasmuch as he carried into his higher station the qualities that had served him so well in his former position, energy, foresight, enthusiasm, and his desire for constant improvement which can never be satisfied. The field over which he was in authority covered from Forest City to Pittston, Pennsylvania. He was recently made vice-president of the company, this being the latest of his promotions in the service of the corporation he has served so well.

His record may be viewed by him with honest and just pride, as each of his many advancements has been the reward of unflagging and energetic attention to his duty. His personal ability is great and his influence in the company's affairs is felt in all departments of their business. Thus at the age of thirty-eight years, Mr. Campbell, should he care to indulge in retrospect, which the spirit of youth never permits, may look upon a play of life in which he has acted well his part, and better, in prospect, may behold scenes upon which the curtain has not yet risen when his role shall be still bigger and better, and in which his successful efforts shall receive, as applause, still greater commendation and reward.

Mr. Campbell is active in Masonic affairs, belonging to Peter Williamson Lodge, Free and Accepted Masons; Lackawanna Chapter, No. 323, R. A. M.; Coeur de Lion Commandery, Knights Templar; and the Consistory, Ancient and Accepted Scottish Rite; as well as to Irem Temple, Nobles of the Mystic Shrine. He is also affiliated with the Benevolent and Protective Order of Elks.

---

#### WILLIAM ROTH

Immigrating to the United States from Austria-Hungary, his native land, William Roth has lived his business life in the state of Pennsylvania. He is a son of Max Roth, a native of Austria-Hungary, whose death occurred when William was but a year and a half old. Max and Hannah Roth were the parents of: Max P., deceased, of New York City, Ludwig, Esther, William, of whom further; Rebecca.

William Roth, son of Max and Hannah Roth, was born in Austria-Hungary, December 25, 1872. He came to the United States when he was fifteen years of age. He became a restaurant proprietor in New York City, so continued for two years, when he moved to Scranton, Pennsylvania, spending one year in the mines of the locality as a slate picker. He was variously employed for the two following years, at the expiration of that time opening a grocery store in Mill Creek, and was its successful owner

for two years. Two years later he returned to Scranton, becoming proprietor of a grocery store at No. 403 Emmett street, afterward purchasing the property at No. 401 Emmett street. On these adjoining lots he erected the brick buildings now occupying the site, continuing his grocery business in its new home and opening a cafe in the other building. Both establishments have enjoyed successful continuance, and Mr. Roth is numbered among the prominent and prosperous merchants of Scranton West Side. He holds membership in Lily Lodge, Independent Order of Odd Fellows, likewise belonging to Brith Abram, the Sons of Jacob, Capital Lodge, and the Scranton City Lodge. His political party is Republican, and he belongs to the Congregation of Beni Israel, No. 1.

Mr. Roth married Cecelia, daughter of Samuel Smulovitz, of Scranton, and has children: 1. Max, a graduate of Central High School, at the present time a student in Harvard University. 2. and 3. Samuel and Joseph, students in Central High School.

---

#### A. LESLEY MAJOR

Four generations of this branch of the Major family have resided in Pennsylvania, the American ancestor, Thomas Major, coming from Yorkshire, England, in 1800. He settled in Wyoming, later locating at Lemon Center, where he died honored and respected. He married Mary Britton, and left issue.

(II) William Major, son of Thomas and Mary (Britton) Major, was born at Lemon Center, Pennsylvania, in 1817. He became a farmer, also having lumber interests of importance. He married Sibyl Brown. Issue: Champin, James, Rachel, Theodore, Abel G., of whom further; Harry.

(III) Abel G. Major, son of William and Sibyl (Brown) Major, was born at Lemon Center, Pennsylvania, March 5, 1843. He was interested in the lumber business with his father as a young man and succeeded him in business, becoming one of the prominent and progressive men of that industry and of his town. He married Helen Santee, born May 5, 1845, daughter of John Santee. Children: Rilla, born 1865; Edith, born September 22, 1868, married John B. Pickard, and has Helen and Albertina, the former wife of Donald Smith; A. Lesley, of whom further; Ernest, died early in 1895.

(IV) A. Lesley Major, son of Abel G. and Helen (Santee) Major, was born at Plymouth, Pennsylvania, December 22, 1870. He was educated in the public schools, Wyoming Seminary, and Wilkesburg Business College. He early became familiar with the lumber business, and from 1890 until 1907 was a wholesale dealer in manufactured lumber of all kinds, located at Wilkesburg, Pennsylvania. In the latter year he moved to Scranton where he continues in the wholesale lumber business as president of A. L. Major Company with offices at No. 712 Traders' Bank Building. He is thoroughly familiar with every detail of his business, having not only the benefit of personal life of experience therein, but also the inherited experience of the two preceding generations to guide him. Mr. Major is a member of the Masonic Order, belonging to Lodge, Chapter, Council, Commandery and Shrine, and a Democrat in politics. He married, June 25, 1895, Eva B. Smith, born May 13, 1872, daughter of Frank and Adelaide (Harrison) Smith. Child, Marcia, born at Nanticoke, Pennsylvania, September 3, 1897. The family residence is at No. 1700 Ridge Row.

## WILLIAM GEORGE ROBERTSON

A prominent financier and all around business man of Scranton, Pennsylvania, William G. Robertson has amply brought into evidence the sterling traits he has inherited from his distinguished ancestry. The family name is of Scotch origin, the Robertsons of Scotland being members of the clan Donnachaidh, or Duncan, so called it is said from Duncan, its founder, a descendant of the Earls of Athol. He was born about 1275, and inherited from his father, Andrew, a portion of the earldom of Athol, and was the first of the lairds of Struan, or Strowan. He was an adherent of Robert Bruce, and entertained and protected that king and his queen while they were in hiding after the defeat of Methven in 1306. The clan has distinguished itself in many wars, and is said to have saved the day at Bannockburn. Many distinguished men in Europe and the United States are descended from the Robertsons of Struan. After the Scottish rebellions many of the Roberstons fled to Ireland, whence they or their descendants came to this country. Others made their homes in England, and left descendants there.

William George Robertson was born in England, October 12, 1853. He acquired his education in the schools of that country. He emigrated to the United States at the age of thirteen years, arriving at Scranton, Pennsylvania, in the month of June, 1866, and for a time attended the public schools of that city. In April, 1867, he accepted a position as clerk in a grocery store, serving in that capacity for five years. He then became bookkeeper and mine clerk for the firm of Filer & Marsh, of Green Ridge, and remained in their employ for a period of ten years. He then went to New Mexico, where he was employed as bookkeeper for Brown Manzanares, the largest wholesale dealer in the town. In 1884 Mr. Robertson returned to Scranton and became bookkeeper for C. P. Matthes & Company at their colliery at Avoca, Pennsylvania, and later entered the employ of the Dolph Coal Company, where he is now superintendent of the mines. He is a director of the Union National Bank, of the United States Lumber Company, and of the Mississippi Central Railroad Company. He is a member of the Presbyterian church; of Peter Williamson Lodge, Free and Accepted Masons, of which he is past master; of the Royal Arch Masons, of Scranton; of Cordelean Council, No. 17, R. and S. M., of Scranton; of Scranton Consistory, Sovereign Princes of the Royal Secret, and has attained the thirty-second degree, being a member of the Nobles of the Mystic Shrine. He resides at No. 632 Clay avenue, Scranton.

---

CHARLES P. JADWIN

Prominent among the business men of Scranton, Pennsylvania, who have contributed energy and ability of a high order to the development of the city, may be counted the name of Charles P. Jadwin. His real estate transactions and projects have shown that faculty of business imagination which is at the back of all large operations of any form of business activity. Not content with the humdrum methods of the conservative real estate man, he has organized schemes that have put his work on a level with business campaigns of the first order. His family is an honored one in Lackawanna county.

Mr. Jadwin was born at Carbondale, Lackawanna county, Pennsylvania, September 13, 1840. He acquired his education in the public schools in the vicinity of his home, leaving them at the age of twelve years. At this early age he commenced his business career, entering the employ of Sweet & Raynor,

druggists at Carbondale, and became a pharmaceutical apprentice. His business career was interrupted in 1861 when he enlisted for three years' service in Company C, Sixth Regiment Pennsylvania Cavalry, and was honorably discharged in 1862. Returning to Carbondale, he formed a business association with his brother, Henry B., and they established themselves in the drug business, with which Mr. Jadwin was connected until the brothers sold the business, when he removed to New York City and there started a drug business with his brother, Orlando H. Of many sided ability, Mr. Jadwin perceived the possibilities of the drug trade in Scranton, and at the end of four years removed to that city where he was identified with this line of business for a period of five years. His mind had not been idle, nor had he allowed his powers of observation to lie fallow, and in 1880 he abandoned the drug trade in order to engage in the real estate business for which his shrewd mind saw a brilliant and profitable future. He was not mistaken in his calculations, as later events have amply proven. It is due to his interest in land speculations that the growth of the city has been so rapidly promoted, and the influence he exerted for the benefit of the city has been felt in many other lines of business industry. In December of the year, 1913, after his brilliant business career, Mr. Jadwin retired to private life. He is a member of the Elm Park Church, and fraternally is a member of Ezra Ripple Post, Grand Army of the Republic. In politics he has always been staunch in his advocacy of the Republican party, and in the early years of his manhood served in the capacity of chairman of the county Republican committee, but in recent years has taken no active interest aside from casting his ballot.

Mr. Jadwin married, September 4, 1861, Augusta Hampton, of Carbondale, and they had four sons, namely: 1. Orlando, died at the age of twenty-eight years. 2. Charles P. Jr., died at the age of twenty-two years. 3. Walter, died in infancy. 4. Rueil, engaged in the automobile business in Scranton; married Margaret Norton, of Scranton; children: Olive, married M. J. Shield, a graduate of Annapolis Naval Academy, now employed in the office of the Delaware Steamship Company; Charles, a student.

---

#### PETER F. DONAHUE

Peter F. Donahue, one of the representative citizens of Scranton, Pennsylvania, is one of that class of men who are adapted to and succeed in whatever line of endeavor they may choose to enter, and whose careers are worthy of emulation by all young men who would make a place for themselves in the world.

He was born in the city of New York, November 12, 1854, and now resides at No. 741 Prescott avenue, Scranton, Pennsylvania. His boyhood days were spent in the city of his birth, where he was educated in the public schools, and from his earliest years his mind was of a decidedly mathematical bent. He entered the employ of the Erie Railroad Company as a messenger in 1885, was made assistant paymaster in 1887, and then advanced to the office of paymaster, a position he filled with ability until 1907, when he came to Dunmore, Lackawanna county, Pennsylvania, and assumed the duties of paymaster of the Pennsylvania Coal Company, the responsible duties of which position he is still discharging. He is a Democrat politically, and a member of the St. Peter's Catholic Church. Mr. Donahue married Ellen A. Hanson, of Buffalo, New York, and they had children: Frank R., William H., Helen, the last named dying at the age of six years. Mr. Donahue has the respect and esteem of all with whom he has had dealings, reliability and faithfulness in the discharge of his duties being among his chief characteristics.

## REV. EDWARD J. MELLEY

The parish of St. John the Evangelist, of South Scranton, was organized in 1886, and since then a new church, convent, parochial school and parish house have been built at an expenditure of \$200,000, now all free from debt. Rev. R. A. McAndrew, appointed by Rt. Rev. Bishop O'Hara, remained in the parish two years and began this work. He was then sent to Wilkes-Barre to succeed Rev. Father Horn, and his place in Scranton was taken by Rev. Father E. J. Melley, who was transferred here from St. Patrick's parish at Olyphant, and here he still remains. Since then the parish has been developed, as noted above, the major part of the work having been done under the direction of Rev. Father Melley.

## CHARLES S. ANDRES

Although one of the youngest men of his profession, Mr. Andres possesses the technical knowledge and qualities of character that insure success, and are already bringing him satisfactory returns. He is the grandson of Matthew Andres, born in Germany, a molder by trade. He came to Scranton at quite an early date in its history and until his death was connected with mining operations.

(II) John Andres, son of Matthew Andres, was born in Scranton, Pennsylvania, in 1861. He was educated in private schools. In early life he learned the carpenter's trade, became an expert workman and for twenty-five years was in charge of large and important building operations in the city. He married Mary Schieber and had issue: Charles S., of whom further; Jonathan, Josephine, Agnes, Lawrence, deceased, Joseph, Theresa.

(III) Charles S. Andres, son of John and Mary (Schieber) Andres, was born in Scranton, Pennsylvania, May 28, 1887. He was educated in private schools, and began business life in the coal department of the Delaware, Lackawanna & Western Railroad as a mechanical engineer, continuing six years. He then spent two years in Hudson, New York, as designer for the Gifford Wood Company, afterward entering the University of Michigan, pursuing for two years a special course in engineering. Feeling confidence in his ability and experience, he returned to Scranton and established as a professional engineer, with offices at 221 Miller Building. He is residing at the present time (1914) in Hudson, New York. Mr. Miller gives especial attention to the designing and installation of elevating and conveying machinery, coal breakers and washeries, coal pockets and power plants. He is a member of the Engineers Club, of Scranton, and is highly regarded in mechanical engineering circles. He is a member of St. John's (German) Church, and of the Knights of Columbus.

## JOHN A. STONE

That America is indeed a land of opportunity has been so often proved by the success of foreign-born citizens, that it is no longer a matter of comment when strangers in our midst rise to positions of trust and rank with the best of our business men in point of financial or commercial importance. Yet opportunity does not supply ability that the individual must supply, so the stranger must be credited with an inborn ability to conquer, as he does, prejudice, language, customs, and grasping opportunity rises above adverse conditions to success. Among the foreign-born but now naturalized citizens of Scranton who have in a quiet and unobtrusive way fairly started

themselves on a prosperous career with bright promise for the future, John A. Stone deserves special mention.

Aslan Stone, father of John A. Stone, was a mason by trade and a man in comfortable circumstances. He married Helen Asfarian, daughter of Hanna and Sarah (Challoian) Asfarian, the latter still living in Turkey, aged one hundred and four years, said even yet to be in good health. She is the mother of thirteen children, all living, Helen being the tenth child. Aslan and Helen Stone have children: Ovsanna, married Saliba Bahooshian, of West Hoboken, New Jersey, and has Alice, Arshag, Samuel and Dolly; Nuvart, married Hagop Demoorgian, of West Hoboken; Jacob A., a salesman in New York City; John A., of whom further; Tumay, living in Turkey, married Boghes Chanasuzian, has a son, Ohannes, and is in the silk manufacturing business in Turkey; Armenia, married Thomas Proudian, and has children: Aram, a student in Scranton High School, preparing for the study of medicine, Toontosh Mehran, Decran T. and three daughters.

John A. Stone, whose name at birth was Ohanness Aslan Tasjian, but who upon coming to the United States, for business reasons only changed it to John A. Stone, was born in Armenia, Asia Minor, Turkey. He obtained a good education in the state schools. He engaged in the dry goods business, and was the owner of a farm which he rented to a responsible tenant. He prospered, but being of the Christian faith he was obliged to flee for safety when the Turkish soldiery began one of their periodical massacres of the unoffending Christians. He managed to reach the coast in safety, taking passage for the United States, arriving in New York City in 1896. He shortly afterward went to Providence, Rhode Island, where for three years he was employed by the National Webbing and Tubing Company, then returned to New York where he was engaged by the John Wanamaker store, as repairer of Turkish rugs. He accumulated sufficient capital to engage in business for himself, and selecting Scranton for a location, settled in this city in 1903. He opened a store at No. 204 Spruce street, where he conducted a successful business under the name of "The New York Dyeing, Cleaning and Pressing Company. He is a member of the Protestant Episcopal church in religious faith. He also belongs to the Knights of the Maccabees, and is a Republican in politics, having been duly naturalized and invested with all the rights of citizenship.

---

#### FREDERICK EDWIN SCOTT

A well established practicing lawyer of Scranton, Mr. Scott, a native of Susquehanna county, Pennsylvania, claims early Colonial ancestry. His forbears were early settlers in Susquehanna county, locating in Montrose in 1808, that year also the date of the first village plat. The original settler, Samuel Scott, came from Southampton, Long Island, he a great-great-grandson of John Scott, who between the years 1657 and 1667 settled in Southampton, going there from Hartford, Connecticut.

Samuel Scott, of the fifth American generation, was a soldier of the Revolution and the founder of the family in Susquehanna county, Pennsylvania. His son, Nehemiah Scott, married Betsey, daughter of Elder Davis and Betsy (Jenkins) Dimock, of an early Montrose family. Their son, Davis Dimock Scott, was born in Montrose, married Seviah, daughter of Dr. Asa Park, and had a son, Asa Park Scott, born 1848, died 1906. He was a farmer near Montrose. He married Josephine, born 1852, died 1905, daughter of Edwin Hill, son of James Wakeman Hill, an early settler near Montrose, but formerly of Fairfield county, Connecticut.

Frederick Edwin Scott, son of Asa Park and Josephine (Hill) Scott, was born in Montrose, Pennsylvania, February 26, 1875. He passed through the various grades of the public schools of Montrose, including high school, then completed the course at Wood's Business College, and entered Keystone Academy at Factoryville, Pennsylvania, whence he was graduated, class of 1895. In 1898 he began the study of law under Carpenter & Fleitz, was admitted to the bar in 1900, and at once began the practice of his profession in Scranton. He has been admitted to the state and federal courts of the district, is a member of the County Bar Association, and is highly regarded as an able and upright lawyer. He is a member of the Baptist Church, and in political faith a Republican.

Mr. Scott married, in 1902, Carrie Fitch, daughter of Judson W. and Eleanor (Bush) Mott, of Montrose, Pennsylvania. Children: Frederick Judson, born December 1, 1906; Josephine Louise, born February 7, 1911.

---

#### DOMENICK BARTECCHI

Domenick Bartecchi is one of the three sons of John Bartecchi, a native of Italy, a railroad employee, who passed his entire life in his native land. His sons, however, were of no mind to eke out frugal existence in their home land, and as youths embarked westward in search of lands where greater rewards awaited industry, economy and thrift than in Italy. The realization of such hope Karl Bartecchi found in South America, the other two, Domenick and Basiglio, coming to the State of Pennsylvania, the latter living in Jessup.

Domenick Bartecchi was educated in the schools of his native land, and after serving an apprenticeship at the carpenter's trade was employed on a railroad, remaining in the service until 1895. In that year he sailed for the United States, landing in New York City and immediately traveled westward to Jessup, Pennsylvania, where he found employment in the mines. He later opened a saloon and grocery store at Jessup, and after continuing business in that place for a few years, moved to Scranton, there opening a saloon, at the same time working in the mines. His business affairs prospered and in 1908 he built a large brick building at the corner of Fairview avenue and Robinson street, there establishing the Pisa Hotel, part of the building being fitted up as a store. As the proprietor of this hotel, Mr. Bartecchi added still further to his material welfare, and until his retirement gave his active and personal attention to his business. At an early age he has retired with a competence that would have been impossible of attainment in his native land, having erected a business that continues in excellent condition at the present time. Mr. Bartecchi is a Democratic sympathizer, and with his wife belongs to St. Lucia Roman Catholic Church. He is also a member of the Ricotte Garibaldi, the San Rocco and the West Side Club. He married Fidelia Caccoli, and has children: John, Julia, Ferdinand, a student in St. Thomas College; Aurora, Victoria, Karl, Joseph. The family home is at No. 119 Fairview avenue, Scranton.

---

#### WILLIAM HENRY RICHMOND

William Henry Richmond, descended from French forbears traced through a long residence in England, and with an American forefather among the first settlers in New England, has added to the honorable record of his ancestors the proud record of twentieth century achievement. In the descent of the name to future generations, new lustre, according to modern

standards, shall be imparted to the glory inherited from the past by the recital of his deeds. Coming from France with William the Conqueror in 1066 to England, the family acquired considerable land in the vicinity of Ashton Keynes, Wiltshire county, England. Here, in the early part of the nineteenth century, Oliffe Richmond owned and occupied the Richmond Manor House, which later passed into the possession of the Nichols family, and became in 1856 the property of the Duke of Cleveland. In 1900 Mr. Richmond, accompanied by his wife and their two youngest daughters, visited England and saw the ancient home of his people.

The American ancestor of the family was John Richmond, an emigrant from Ashton Keynes, Wiltshire county, England, who in 1637 became one of the original purchasers of Taunton, Massachusetts, coming on a trading expedition in 1635. He was a large land owner and regarded as a wealthy man, prominent in all affairs relating to local government. William H. Richmond is also connected with one of the most famous of New England families through his grandmother, Prudence Wadsworth, by a sixth generation descent from William Wadsworth, an emigrant from England to Massachusetts in 1632, and, under Hooker, one of the early Connecticut colonists in 1636, whose son, Captain Joseph Wadsworth, is credited with concealing the Connecticut Charter in the Oak Tree at Hartford, when it was shown that the governor appointed by the English Crown would accede to none of their requests.

John (2) Richmond, son of John (1) Richmond, the emigrant ancestor, by his marriage with Abigail Rogers, of Duxbury, Massachusetts, connected with family of "Mayflower" descendants, Thomas Rogers, one of the signers of the compact, being her grandfather, the father of John Rogers. Also with Elder William Brewster, Francis Cook and Henry Sampson.

Robert Richmond, the fifth of the line in America, served for two years, eleven months and twenty-six days in the Colonial army during the Revolutionary War, gaining honor and distinction. He married Martha Hinde, daughter of John and Alice (Smith) Hinde, and their eldest son, John Richmond, born 1764, studied medicine with Dr. Timothy Hall, of East Hartford, commenced practice in East Hampton, Connecticut, and died December 10, 1821; he married, in 1795, Prudence Wadsworth, above mentioned.

William Wadsworth Richmond was a native of Chatham, Connecticut, where he was reared and educated. He followed his trade of blacksmith and foundryman, in connection with farming operations, at Marlborough, Hartford county, Connecticut, where he settled in 1820. During the panic of 1837 his business was swept away, carrying with it the accumulation of years of thrift and industry. He married, November 10, 1819, Clarissa Bailey, daughter of Nathaniel and Rachel (Sears) Bailey, of East Hampton, Connecticut. William W. Richmond died in Marlborough, May 31, 1843, surviving his wife a number of years, her death occurring October 26, 1834. Captain Elkanah Sears, father of Rachel (Sears) Bailey, was a member of the committee appointed to provide for the wants of the Continental army in the year 1780. At the outbreak of the Revolution he equipped and commanded a vessel which made a practice of preying upon British convoys until captured by a British ship. When the capture was made, he and another patriot were made prisoners. Overhearing plans for their execution in the morning they dropped unnoticed over the side of the ship and were well on their way toward shore before shouts on the vessel showed that their escape had been discovered. Fire was immediately begun upon the fugitives, and partly from physical exhaustion and partly mental terror, Captain Sears' companion sank. Captain Sears swam to his rescue and



succeeded in getting him safely to shore and into the woods, which came down to the water line, and they escaped. He later equipped another privateering vessel which performed excellent service.

William Henry Richmond, eldest son of William Wadsworth and Clarissa (Bailey) Richmond, was born in Marlborough, Hartford county, Connecticut, October 23, 1821. He was educated in the public schools of his native place, and a select school in Middle Haddam, Connecticut, taught by Israel M. Buckingham, brother of Governor Buckingham, of Connecticut. He engaged in business life in his thirteenth year as a clerk in a store at Middle Haddam, Connecticut. In 1837 the panic crippled his employer's business to such an extent that there was no work for the lad, and accordingly he returned home and there found a similar condition of affairs. He remained on the home farm five years, attending school, working on the farm and in the shop. In 1842, failing to secure employment in Hartford, he visited an uncle in Dutchess county, New York, meeting Robert H. Moore, of Socrates, New York, a merchant, and with him went to Honesdale, Pennsylvania, remaining in Mr. Moore's employ three years. He then established a general store in Carbondale, Pennsylvania, in partnership with a Mr. Robinson, under the firm name of Richmond & Robinson. Their store was said to have been the first store building in Carbondale, erected by Mr. Lathrop, father of Charles E. Lathrop, editor of the Carbondale Leader. They continued in general merchandising until 1853, when Mr. Richmond became sole proprietor. Two years previously the firm had added to their business of general merchandise a factory for making doors, sash, blinds, coal cars and other wood work, installing wood-working machinery, which being the first of that kind introduced in the Lackawanna and Wyoming Valley met with opposition from mechanics, who considered it an abridgment of the chances of labor. In 1859 and 1860 there were eight hundred coal cars built at his factory, with the exception of axles and wheels, for the Delaware & Hudson Company for use on the gravity railroad leading to Honesdale, the head of their canal. He also furnished the sash for round house and shops at Scranton, 1851, which is now called the Delaware, Lackawanna & Western Railroad, by contract with a painter named Chambers. On September 15, 1855, his store was burned, entailing a considerable loss, but on January 15, 1856, a new store building, sixty by one hundred feet, three stories high, was completed, and fitted up in a style then unknown in that section. He disposed of his store and building in 1867, having six years previously disposed of his planing mill.

In January, 1860, Mr. Richmond commenced mining coal in Blakeley township, near Scranton, Pennsylvania, under the firm name of Richmond & Company, his partner being Charles P. Wurtz, general superintendent of the Delaware & Hudson Canal Company. They erected one of the first coal-breakers on the line of that road, and commenced the breaking, screening and assorting of the coal into different sizes for the market, the previous practice having been to ship it in lump from the mine. In 1863 the firm was merged into the Elk Hill Coal Company, by special charter, with Mr. Wurtz, president, Mr. Richmond, treasurer and manager. The following year Mr. Wurtz withdrew, and George L. Morss acted as president, continuing until 1880, when he was succeeded by Mr. Richmond, who had ever been chief stockholder and owner. Two supplements of different dates to charter gave increased privileges as to issue of stock and loans, and holding of lands. The original names signed to the application to the legislature for the charter were: William H. Richmond, Charles P. Wurtz, George L. Morss, Alfred P. Wurtz, and George L. Dickson, the venerable vice-president of the

First National Bank, of Scranton, whose only interest was his aid in the organization, after the charter was obtained. In 1883 the breaker was destroyed by fire, and the following year another was built near the Brisbon Colliery in the second ward of Scranton.

The present coal-breaker belonging to the company was erected in 1889 in Dickson City, a mile distant from the shaft, which reaches about ninety feet to the rock, and two hundred feet to the fourteen foot bed of coal, thence through five lower beds to the depth of six hundred feet. This colliery has been in operation since 1891, and has capacity for shipping one thousand tons or more a day. In 1891 the company leased about one thousand acres of coal lands, on the estate of George L. Morss, in Fell township, about five miles above Carbondale, at the village of Richmondale, and this colliery, having a capacity of fifteen hundred tons per day, began shipping coal, in 1893, over the Richmondale branch of the New York, Ontario & Western Railroad. At this colliery Mr. Richmond conceived the idea of placing over the shaft, which is sunk two hundred and twenty feet through two beds of coal seven and eight feet thick, a steel tower one hundred and eighty-seven feet high, connected with a coal-breaker building, two hundred feet away, by a steel chute, supported on two intermediate towers, from which the coal gravitates to the larger and smaller rolls, and thence through the many screens to be sorted and prepared for shipment. This chute is built in accordance with the Pennsylvania mine laws, which stipulate that coal breakers must be at least two hundred feet from the shaft. The loaded coal-cars are placed at the foot of the shaft in the mine, are raised one hundred and fifty feet above the surface, and by automatic arrangement the coal is emptied from the car without running from the carriage. This is the only known operation of the sort, and it is of much economy in working coal.

Since the arrival of Mr. Richmond in Pennsylvania, in 1842, a revolution has been brought about in the coal trade. In that year the entire production of the Delaware & Hudson Canal Company, or indeed of the Lackawanna and Wyoming valleys, was two hundred and five thousand tons, all mined at Carbondale; the entire production of anthracite up to that time was one million one hundred thousand tons; bituminous coals were marketless; the cost of mining and transporting to Honesdale, no coal being broken, was about one dollar per ton; the price paid miners was twenty-eight cents per ton in winter and thirty-five cents in summer. In 1912 some seventy million tons were mined in the state, worth nearly two hundred million dollars at the mines, and nearly one hundred and twenty million tons of bituminous coal were mined. The mines were idle some three months in winter.

Aside from his extensive mining and mercantile operations, Mr. Richmond engaged in the file making business for a number of years, fire destroying the plant in 1884. He was the projector and first president of the Crystal Lake Water Company, of Carbondale, and gave the organization its name, and was one of the original stockholders of the Carbondale Gas Company. He was one of the original stockholders, and a director of the Third National Bank of Scranton; was one of the directors of the Scranton Railway Company, a branch of the New York, Ontario & Western Railroad, to encourage the building of which he made the first offer of fifty thousand tons of coal yearly as freight, and afterwards the full production of the mine and colliery built at Richmondale.

Mr. Richmond is a member of the Scranton Board of Trade; the New England Society of Northeastern Pennsylvania; Connecticut Society of Sons of American Revolution; the Society of Mayflower Descendants; American

Institute of Mining Engineers; National Geographic Society; Franklin Institute; American Bible Society, serving as treasurer of the Lackawanna Bible Society for the past thirty years; American Association for the Advancement of Science; American Jersey Cattle Club, and a patron of the Egyptian Exploration Fund.

While in political views, Mr. Richmond agrees with many of the principles of the Republican party, but for the moral effect it may have upon his associates he gives his loyal support to the Prohibition party, whose candidate for Congress in the twelfth district he was in 1868 and in 1904. Since attaining man's estate he has been actively identified with the Presbyterian church, and his name appears frequently upon the contribution lists of many religious organizations, his duties and obligations in these matters being as fully realized and as conscientiously fulfilled.

Mr. Richmond married, June 5, 1849, Lois Roxanna Morss, of Windham, Greene county, New York, daughter of Foster and Roxanna (Kirtland) Morss. Children: 1. Mary Roxanna, educated at Vassar College, graduated in 1876; married, October 6, 1881, Frederick K. Tracy, an attorney-at-law, from 1893 to 1899 vice-president of the Elk Hill Coal & Iron Company, and since 1899 engaged in legal practice in Scranton; their children: Lois Richmond, graduated at Vassar College; Emeline Kirtland, educated at Dwight School, Englewood, New Jersey; William Richmond, graduated at Princeton University; Mary Avery, graduated at Vassar College; Frederick L., now preparing for college. 2. Emeline Kirtland, educated at Vassar College; married Dr. Julius D. Dreher, for twenty-five years president of Roanoke College, Salem, Virginia, in 1906; went to Tahita where Dr. Dreher was United States consul for four years, thence to Port Antonio, Jamaica, and in January, 1914, transferred to Toronto, Canada, as consul. 3. Clara Morss, educated at Vassar College, remains with her father. Two other children died in infancy.

Mr. Richmond is the owner of one of the finest residences in the Lackawanna Valley, which he erected in 1874, on Richmond Hill Farm, which contains seventy-five acres, located in the northeastern limits of the city of Scranton. Here, amid palatial surroundings, in a magnificent manor, he enjoys a home life of rare sweetness and beauty. After days spent in the busiest centers of the industrial world, nothing could so cheer his wearied spirits, or give a more enlivening satisfaction, than the relaxation found in his home circle.

It is indeed unusual to find in the daily life of a man so deeply engaged in such involved business relations evidences of a pure and enduring sentiment, observed with the most punctilious regularity. Until he was forty-two years of age, Mr. Richmond was a moderate user of tobacco, and then, becoming convinced of the baneful effects of the unnatural habit, he abandoned his pipes and cigars. As a reminder of his resolution, he began the practice of wearing a bouquet in his buttonhole. The beautiful blossom always seen adorning Mr. Richmond's coat lapel has become so firmly identified with the man that to see him without it would cause the greatest possible surprise. The fresh and fragrant beauty of the flower, carrying with it the breath of the free, open country that was its home, has been a source of more pleasure to his business associates, bound to the dull grind of daily toil, than the satisfaction of a quiet smoke ever could have been to Mr. Richmond.

A man of many parts, keen and farsighted in business dealings, of deep and true religious conviction, a liberal supporter of the arts and sciences, and a citizen of strength and character, Mr. Richmond stands as one of

the most distinguished members of Scranton society, the epitomization of unimpeachable integrity.

---

### JACOB R. SCHLAGER

Baden-Baden, Germany, the home of the oldest of the world-famous German universities, Heidelberg, was the birth-place of the progenitors of the Schlager family. That the representatives of the name should attain position and distinction in their adopted land by their courage and persistent endeavor is entirely fitting and proper, as the first bearer thereof must have gained the cognomen through his valor as a warrior and bravery in struggle, the word existing in the German language at the present time and carrying with it the idea of those attributes.

Jacob Schlager, father of Jacob R. Schlager, was born in Baden-Baden, Willstadt, Germany. He attended the schools in the vicinity of his birth-place until he was sixteen years of age, when he left his home, and boldly turning westward crossed the Atlantic Ocean. He arrived in the United States about the year 1849, unacquainted, not familiar with the language, and insufficiently supplied with money. In spite of these handicaps he found no difficulty in obtaining the work he was so anxious to find, remaining for a time in Honesdale and Hawley, but finally taking up his residence in Scranton. One of his early occupations was that of lock-tender on the Delaware and Hudson canal, and on his arrival in Scranton he became driver of the first bakery wagon seen in the city, the business being owned by his uncle, Charles Schlager. When the news of the gold discovery in California was made known in the east, he was among the horde of men who, fired by the spirit of sudden and immense wealth, left homes, trades and position to seek the precious metal in the wilds of the west. More cautious than most of the gold-crazed throng, Mr. Schlager chose the safer, though longer, route across the Isthmus of Panama, rather than brave the perils of the desert, the relentless destroyer that claimed so heavy a toll from the gold-hunting travelers. After a three years' search for enough of Midas' metal to justify his journey, he abandoned his quest and returned to Scranton, no richer than when he left and having paid for his ambitious desires with a long period of unrewarded toil. After his arrival in Scranton, he established in business and was actively engaged in the same until the death of his wife in the year 1872. This was a heavy blow to him and one from which he never entirely recovered. The closing years of his life were spent in quiet retirement after a life of strenuous action and unremitting labor, his death occurring December 28, 1904. He was a consistent member of the German Lutheran Church, an honorable, God-fearing Christian. He married Catherine Gottwals, and they were the parents of two children: Jacob R., of whom further, and George, who died in 1900.

Jacob R. Schlager, son of Jacob and Catherine (Gottwals) Schlager, was born in Scranton, Pennsylvania, August 29, 1866. He attended the public schools of his native city, and upon the completion of his studies entered the office of the Stowers Pork Packing and Provision Company, May 28, 1879, a firm that has claimed his services ever since. His fidelity to the interests of the company and his loyal efforts for their advancement speedily won for him the favor and approbation of those in office above him, while his sterling honesty and cleanness of character made him their trusted confidant. His steady advance in the business has been the result of the persistent proofs of his ability shown day by day, recognition of the intimate and accurate knowledge of its different departments. In 1894 he was promoted to the responsible position of manager, in which capacity he rendered efficient service, and at

the present time (1914) is filling the honored position of president of the organization. The Stowers Pork Packing and Provision Company, organized in 1862, now gives employment to one hundred persons, thus making it one of the leading enterprises of the city, the greater part of its trade being conducted in the eastern part of Pennsylvania.

Mr. Schlager is deeply interested in all the affairs concerning the welfare of his city. For two terms he was a member of the board of education, serving for one year as chairman of that body, and during his membership his best efforts were directed toward raising the educational standard of the city and in procuring the best talent obtainable as instructors. In the year 1913 he was elected to the office of county treasurer, receiving a large majority of the votes cast at the polls, his term of office to expire in 1917. His political affiliation is with the Republican party, the principles of which he believes to be for the best form of government. He is actively connected with several fraternal organizations, and holds membership in the Scranton Bicycle Club, the out-of-door life and the pleasurable exercise appealing strongly to his love of nature and athletics. For three years he held the one mile bicycle championship of Pennsylvania, and at different times was the holder of the three, five and ten mile records. Mr. Schlager's influence is always felt in every movement beneficial to the city. An honored, upright and straight-forward business man, he carries all of these qualities into his private life, and is one of the highly respected citizens of his city.

Mr. Schlager married Edna Freeman, daughter of Thomas J. Freeman, of Scranton, and they are the parents of three children: Jacob R. Jr., Catherine Elizabeth, Jean Freeman.

---

#### THEODORE CRAMER VON STORCH

Theodore Cramer Von Storch was of noble Swedish origin. He was the grandson of Heinrich Ludwig Christopher Von Storch, who was the grandson of Dr. John Gustav Von Storch, grand duke of Mecklenburg-Schwerin and councillor and burgomaster of Guestrów, the largest city of Mecklenburg, a descendant of Ian Person Von Storch, who was knighted and made a nobleman for services in driving the Danes out of Sweden, and given a castle at Salis where he established the Von Storch family. In 1794, Heinrich Ludwig Christopher Von Storch, the grandfather, came to this country with one, G. N. Luyten, and engaged in the fur trade in Philadelphia, Pennsylvania. They secured a cargo of furs, and consigned the ship to a European port, but it was never heard of afterwards. They then came to this end of the state and located at what is now Blakeley in this county. The grandfather purchased a tract of 300 acres of wild land which he cultivated more or less, dividing his time for several years between the rough backwoods farm and his first house in Philadelphia. In clearing this wild land he suffered an injury to his back, which compelled a lighter occupation, and he took up the then popular and lucrative business of local trading, carrying his goods on boat. On one of his early trips back to Philadelphia he carried a bag of coal from his own land, and tried to interest some of the wealthy men of that city in the "Stun Coal," but without success. In 1810 Mr. Von Storch married Hannah Searle, of Wilkes-Barre, Pennsylvania, and thenceforth made a permanent home in a log house of his own building on his wild farm. They had seven sons and one daughter.

Theodore Von Storch, second son of Heinrich Ludwig Christopher and Hannah (Searle) Von Storch, and father of Theodore Cramer Von Storch, was born in 1812, in the primitive log house. He came to Providence, Lu-

zerne county, Pennsylvania (now the upper end of our city) in the late thirties. In 1840 he built a comfortable dwelling, and was one of the substantial men of that village. In 1872 he built what has long been known as the handsome Von Storch homestead on North Main avenue. He married Josephine D. Barney, of Milton, Vermont. There were born to them two children: Theodore Cramer and Mrs. Frank M. Vandling.

Theodore Cramer Von Storch was born in Scranton, Pennsylvania. He was educated in the School of the Lackawanna, Scranton, Pennsylvania, and in Harvard College, from which he graduated with honors, and was admitted to the bar of Lackawanna county. He assisted in organizing the People's National Bank and was a member of its board of directors. He was also interested in many other of the business enterprises of the city of Scranton. He married Jessica Pennypacker, in Scranton, in 1896, and there were born to them two children, William and Theodore Constant, who survive him. He died September 1, 1913.

---

#### CONRAD F. SHINDEL

A resident of Scranton since 1906, Mr. Shindel has attained an excellent position in the few years that have since elapsed. He is a descendant of an old Pennsylvania family; his father, Conrad F. Shindel, was a practicing lawyer of Schuylkill county. He married Louise Bailey, daughter of Milton Bailey. Children: Clarence B.; Ella M., married J. F. Ellick; Louise, married H. G. Dunham; Elizabeth, married Frank C. Geer; Charles S.; James E., who died in the United States navy; Conrad F., of further mention. Conrad F. Shindel, the father, died March 10, 1890, his widow, Louise (Bailey) Shindel, surviving him until January 27, 1911.

Conrad F. (2) Shindel was born in Tamaqua, Pennsylvania, November 8, 1875. He obtained his early education in the public schools, then entered Wyoming Seminary at Kingston, Pennsylvania, where he completed a full course and was graduated. He pursued clerical occupation until the outbreak of the war with Spain, when he enlisted in Company B, Eighth Regiment Pennsylvania Volunteers, in 1898, remaining in the service until mustered out at Augusta, Georgia, in 1899. He then returned to Tamaqua where he was successfully engaged in the insurance business until 1906, when he located in Scranton, becoming teller of the Dime Deposit and Discount Bank, and remaining with that well known institution four years, gaining a valuable fund of experience. In November, 1910, he was chosen cashier of the First National Bank of Dunmore, a position he now holds most satisfactorily to the officials and patrons of the bank. He is thoroughly capable and has the confidence of the business public to an unusual degree. He is a member of Tamaqua Lodge, Benevolent and Protective Order of Elks. Mr. Shindel married, October 8, 1904, Margaret, daughter of William D. and Mary Thomas, of Lansford, Pennsylvania; children: Harry Dunham, died in infancy; Conrad F. (3), born October 9, 1907; William F. C., born March 15, 1909.

---

#### GEORGE EZRA HAAK

Five generations of the Haak family in Pennsylvania have been identified with the commercial life of the Commonwealth, and two generations particularly with the coal and iron industry, while the present generation is represented by George Ezra Haak, superintendent of buildings and supplies of the school district of the city of Scranton. Samuel Haak, grandfather of

George, was a native of Reading, Pennsylvania, and was at one time superintendent of a blast furnace at Temple, Pennsylvania, out of which later developed the well known Temple Iron Company.

Ezra Jacob Haak, son of Samuel, was born in Berks county, Pennsylvania, and for many years was special agent for the Philadelphia & Reading Railroad Company. He was also part owner of a large general store at Pine Grove, Schuylkill county, Pennsylvania, and at the time of his death was in the sugar brokerage business in Philadelphia. He was a very successful business man, amassed a considerable fortune, and at his death on March 17, 1908, was sincerely mourned by a large circle of business associates who had learned to admire and respect him for the upright principles that had determined his life. He married Sarah Drine, and had children: Harry C., a resident of Scranton; May, who resides in Pine Grove, Pennsylvania; and George Ezra, of whom further.

George Ezra Haak, son of Ezra J. and Sarah (Drine) Haak, was born at Pine Grove, Schuylkill county, Pennsylvania, November 11, 1880, and obtained a public school education at that place, graduating from the high school in 1897 at the head of his class. Mr. Haak came to Scranton to attend the Scranton Business College, and finished a business course in this school in 1899. Immediately after graduation he accepted a position in the superintendent of transportation department of the Delaware, Lackawanna & Western Railroad Company, where he remained until August, 1905, when he became connected with the International Salt Company, his employers until January, 1912. About that time the new school code became operative in Pennsylvania and many changes were made in the management or control of the schools in Scranton. The new school board created the office of superintendent of buildings and supplies, a department to look after the purchase of all supplies used in the school district, as well as the management and care of the large property under their control, and Mr. Haak was selected from a large number of applicants to fill the position. The city has in him a servant of wisdom and temperance, and one who has already made a splendid record in the handling of this important position.

Mr. Haak married, in 1906, Emily Clare, daughter of Dr. F. D. and Emma (Wilson) Brewster. They have three children: Dorothy, Mary, and George Jr. Mr. Haak is a member and deacon of the Second Presbyterian Church of Scranton; belongs to the Scranton Engineers Club; Board of Trade; Peter Williamson Lodge, Free and Accepted Masons; Camp 49, P. O. S. of A.; Artisans Order of Mutual Protection; and the Young Men's Christian Association.

---

#### JACOB D. BAMBACH

New York is the locality whence came Jacob D. Bambach, carpenter and builder of Dunmore, assessor of the third ward of that borough for the past four years, his parents, Jacob and Christiana (Hetzl) Bambach, leaving New York City when he was a boy of five years, the family making the trip to Lackawanna county, Pennsylvania, in a Conestoga wagon, which carried, besides their household goods, supplies and provisions for the trip, since nightfall might overtake them without a stopping place near. The mother of the family now resides at the old home on the corner of Ash and John streets. The family settled in Scranton, where Jacob B. Bambach was reared and where he attended school. After finishing his education he was for a time in the service of the Pennsylvania Railroad, beginning carpenter work when he was twenty-four years of age and continuing in that line to the

present day. As a journeyman carpenter he has been employed on much construction work in the vicinity of Scranton, and as a contracting builder has had charge of numerous operations, meeting with success and prosperity in this business. In 1910 he was appointed to fill the position of assessor of the third ward of Dunmore, a place formerly occupied by G. B. Allen, and now serves Dunmore in that capacity, that being the only office he has held in public service, his political action independent.

Mr. Bambach married Elizabeth Brick, born in Scranton, Pennsylvania, daughter of Jacob Brick, and for one year after his marriage was a resident of Scranton, then moving to his present home at No. 412 William street, Dunmore, Pennsylvania. Of the ten children of Jacob D. and Elizabeth (Brick) Bambach, six are now living, four daughters and two sons. Mr. Bambach is a communicant of St. Peter's Lutheran Church.

---

#### MICHAEL J. DEMPSEY

For many years Ireland has been sending her sons and daughters to this country, which grants them many privileges denied them in their native land. Many of the thousands who emigrate find their way into the state of Pennsylvania, where their attention is turned to mining and other avocations in which skilled labor is not a requisite. Michael J. Dempsey, well known as a merchant of Dunmore, Lackawanna county, Pennsylvania, is a son of one of these emigrants.

James Dempsey, the father, was born and grew to manhood in Ireland. In early manhood he emigrated to the United States and worked for many years in the mines. He retired about fifteen years ago, and has since lived in retirement at No. 714 Monroe avenue. He casts his vote regularly for the candidates of the Democratic party, and is a devout member of St. Paul's Catholic Church. He married, in this country, Nora Durkan, also born in Ireland, and they had six children.

Michael J. Dempsey was born in Scranton, Pennsylvania, January 15, 1882. He was five years of age when he came to Ward 6, Dunmore, with his parents, and there attended the public schools until nine years old. All his schooling was crowded in these few short years, but Mr. Dempsey spent his spare moments in so wise a fashion, that these early obstacles to a rise in life were overcome in a most admirable manner. A part of this educational period was spent at St. Paul's Parochial School. At the age of nine years he commenced working at the breaker at Scranton, remaining there five years, and then spent some years in the Scranton Stove Works as a molder. A commercial life had always strongly appealed to him, and in 1903 he established himself in the tea and coffee business in Dunmore, and is now the owner of the Dunmore Tea Company, of No. 215 East Drinker street. Mr. Dunmore has taken a prominent part in the public affairs of the community in which he lives, and in 1913 was elected to the office of borough tax collector of Dunmore for the term of four years.

Mr. Dempsey married Anna, a daughter of Michael Gordon, of South Side, Pittsburgh. Children: Joseph and James. The family resides at No. 1621 Electric street, Dunmore, and he is a member of Knights of Columbus, Workmen of the World, Town Club of Dunmore and St. Mary's Catholic Church. Mr. Dempsey stands as a representative of a high type of American manhood. He combines energy and determination with lofty principles, so that his career in business, in politics, in social circles, has been characterized by laudable ambition and honorable effort.



## REV. FRANCIS VALVERDE

For the past eight years Rev. Francis Valverde, born in Palermo, Sicily, has been pastor of St. Anthony's Roman Catholic Church, of Dunmore, Pennsylvania, that having been his second charge since the beginning of his connection with the American branch of the Roman Catholic Church. Before assuming his place as a member of the clergy he was favored by educational advantages of unusual attractiveness, and he entered the ministry endowed with all of the embellishments of university training, having made high and worthy use of his liberal scholastic culture.

Rev. Francis Valverde was born March 7, 1877, and was reared in his native city, the capital of Sicily, attending, upon the completion of his preliminary schooling, Messura Seminary, whence he was graduated in 1899. He then became a student in the University of Palermo, and was later a college professor, occupying the chair of languages. Having been ordained to the priesthood of the Roman Catholic Church, he decided for service in other lands than that of his birth, and was assigned to duty in the United States, his first charge being at Freeland, Pennsylvania, where he remained for one year. At the expiration of this time he was placed in charge of St. Anthony's Roman Catholic Church at Dunmore, where he remains to the present time, a prominent figure in ecclesiastical activities in the borough. His parish contains about four hundred and fifty families, a large proportion of which are regular attendants at church services. Soon after his arrival in Dunmore Rev. Valverde prepared a new curriculum for the school maintained by the church, and after the same was placed in operation become instructor in Italian, meeting his classes in the school daily, a duty that, added to his other clerical responsibilities, makes his existence a busy one.

---

PETER F. REILLY

Numbered among the representative business men of Dunmore is Peter F. Reilly, who is successfully engaged in real estate transactions, but who nevertheless finds time to devote to the welfare of his native city and has been chosen to fill various offices of trust and responsibility, the duties of which he has discharged in a highly commendable manner.

Mr. Reilly is of Irish parentage, his father, Thomas Reilly, having been born in county Mayo, Ireland, and his mother, Mary (Moran) Reilly, is a native of county Sligo, Ireland. His parents were reared and educated in their native land, from whence they emigrated to the United States, locating in Dunmore, Pennsylvania, where Mr. Reilly secured work as a miner, being a capable and experienced man. He lost his life by an accident in the mines, September 3, 1885. Mr. and Mrs. Reilly were the parents of nine children, five of whom are here mentioned: John; Peter F., of whom further; Patrick J.; Jane, wife of James Canley; Margaret. The mother of these children is still living and resides in Dunmore.

Peter F. Reilly was born in Dunmore, Pennsylvania, October 3, 1866. He attended the common schools of his native city until he was ten years of age, then entered the mines as breaker-boy for the Pennsylvania Coal Company, and there followed the various branches of mining, rising step by step until he became a coal operator and later a mine owner. Subsequently he turned his attention to an entirely different line of work, real estate, in which he is equally successful. For many years he served as treasurer and general manager of the Dunmore Coal Company, and was one of the directors of the Northern Anthracite Coal Company, also a director of the

First National Bank, of Dunmore. In the year 1894 he served the borough of Dunmore in the capacity of auditor; in 1900 was elected tax collector of Dunmore, an office to which he was re-elected in 1903, and at the expiration of his second term was elected clerk of the board of county commissioners, which office he filled until 1911. He is a member of the Benevolent and Protective Order of Elks, the Improved Order of Red Men, the Knights of Columbus, the Ancient Order of Hibernians, of which he was secretary, and the Young Men's Temperance Literary and Benevolent Society, of which he was president.

Mr. Reilly married (first) Bridget E. Quinn, a native of Dunmore, Pennsylvania, daughter of James and Bridget Quinn. She died aged thirty-nine years. He married (second) Nora E. Collins. Children of first wife: Ruth, Mary, Florence, James, Thomas, Mabel, deceased; Peter, deceased; Alice, deceased; Eulalia.

---

#### EDWIN R. PARKER

With the retirement from business of Edwin R. Parker, of No. 321 Spruce street, Scranton, Pennsylvania, a familiar personality will be missed from that locality. Mr. Parker had been for many years a dealer in sporting goods at this location, engaging in this business after fifteen years previous mercantile experience in Scranton, and during this time held the patronage of the athletes and sportsmen of Scranton, holding well his own in competition with others in the same line.

Sheldon W. Parker, father of Edwin R. Parker, was born in Abington, Pennsylvania, in 1804, died in 1856. He was a successful farmer, which occupation he followed throughout the active years of his life. He married Sarah Phillips, born in 1810, and they were the parents of five children, namely: Rondino, a farmer on the old homestead at Abington, Pennsylvania, married Diana, daughter of Ebenezer Slocum; Corintha, deceased, married Orrin Culver; Edwin R., of whom further; Hulda, deceased; Fernando, a farmer in Waverly, Pennsylvania.

Edwin R. Parker was born in Abington, Pennsylvania, October 12, 1839. He obtained his education in the public schools of his native place, and he was employed on his father's farm until the outbreak of the Civil War. In October, 1861, he enlisted in Company K, Fifty-second Regiment Pennsylvania Volunteer Infantry, and served as a member of this company for three years and one month, receiving his honorable discharge in October, 1865. In April of the following year he came to Scranton, entering a machine shop and learning the trade of machinist, and three years later formed a partnership with John L. Hull and a Mr. Gunster, the firm locating on Lackawanna avenue and trading for twelve years as Gunster, Hull & Parker, furniture dealers. For two years thereafter Mr. Parker was a commercial traveler. About 1880 he established the first bicycle shop in this locality, later adding a complete line of general sporting goods, and shortly afterwards he erected the building located at No. 321 Spruce street, which continued to be the home of the E. R. Parker Store. His business career was a successful one, his store ruled by principles of value and fair dealing, and he was one of the well-esteemed and highly-regarded merchants of the city. Mr. Parker is a communicant of the Washburn Street Presbyterian Church, and in politics is a Republican. The family home is at No. 1114 Washburn street, Scranton.

Mr. Parker married Marion Mears, daughter of Sidney Clark and Janet Mears, who were the parents of six children, as follows: Marion, of previous

mention; John A., James R., Joseph A. and William Sidney, all prominently identified with the early business life of Scranton; Margaret M., who became the wife of J. Alton Davis, an attorney of Scranton.

---

#### ESDRAS HOWELL

The Howells are an ancient family of Wales. Esdras Howell, who, to quote a contemporary was "small of stature but with a heart as large as he was small, Esdras Howell had hundreds of warm friends who loved him living and mourn him dead," being the first of this immediate branch to come to the United States, following the example of one of his brothers.

Esdras Howell was born at Sant Donias, Glamorganshire, Wales, September 9, 1832, son of Rev. Louis and Ann Howell, the former a minister of the Baptist church. He remained in his native parish, obtaining a good education until 1849, when he came to the United States, finally settling in Carbondale, Pennsylvania, where an elder brother had preceded him and established in the mercantile business. Esdras Howell entered his brother's employ, continuing until 1856, when he came to Scranton, locating on the West Side, where under the firm name of Richard & Howell he engaged in general merchandising. He became one of the best known men of the West Side, where his long after life was spent, and also of Scranton, as for several years he was traveling representative for the wholesale grocery firm of James B. Power & Company of New York. He was very popular with his countrymen, who, when Mr. Howell was the Democratic candidate for controller of the city of Scranton in 1899, swept him into office by one of the largest majorities a candidate ever received in that city. They forsook party and in every Welsh Republican district, on the West Side, he was given a majority.

Mr. Howell was very fond of children, and of the younger generation there are few who did not know and admire him. In his latter years poor health kept him indoors a great deal, but when he did appear was accorded a warm greeting everywhere. He was a thorough optimist, and to meet him under any circumstances, or to listen to his joyous, mirthful laugh, was a tonic to the aged and encouragement for the despondent. He lived with the happiness of others as his gospel, and in so doing brought joy also to his own heart. His joyous laugh was not hushed even in his last illness, nor his hearty greeting to his bedside visitors lacking, until the coma which preceded his death several days barred out all conscious knowledge of his surroundings. Mr. Howell was a member of the Masonic Order, belonging to Hyde Park Lodge, his brethren being in charge of his funeral services, which were conducted at Forest Hill Cemetery, according to the beautiful ritual of the order.

Mr. Howell married, April 4, 1867, Mary Williams, of Manch Chunk, Pennsylvania, who preceded her husband to the grave several years. She was a fitting helpmate, and their home on Washburn street, when both were young, was the scene of much merrymaking. Children: ———, married Charles A. Hartley, of Scranton; Anna, married ——— Van Mawr, of St. Louis, Missouri; Louisa A., of Scranton; John W., of whom further.

John W. Howell, son of Esdras and Mary (Williams) Howell, was born in Hyde Park, Pennsylvania, May 15, 1879. He was educated in the public schools of Scranton, finishing his studies in the high school. His first business experience was as a paper boy for J. A. Scranton, then after some time spent in New York City he became a real estate dealer and broker, in which business he is now successfully engaged, with offices at Nos. 212-213 Mears Building, Scranton. He is an independent Democrat, and a member of several social

and fraternal organizations. Mr. Howell married Nellie I., daughter of ex-Mayor John H. Fellows, a sketch of whom follows this in the work. Children: Lois, Jean, Esdras (2).

---

### JOHN H. FELLOWS

Ex-Mayor John H. Fellows, one of the most useful and public-spirited citizens of Scranton, was a descendant of Joseph Fellows, born near Sheffield, England, who came with his family of eight to the Scranton district in 1790, locating at what is now Hyde Park. He patented several tracts of land in that section, becoming one of the large land owners and speculative dealers. He served as justice of the peace and conveyancer of lands. Among his vast possessions were many acres of the richest coal land in the region, which he sold without knowledge of their true value. When he was about eighty years of age he was engaged in successful litigation with Dr. Malone, the result so enraging Dr. Malone that in a frenzy of passion he struck Mr. Fellows on the head with a heavy walking stick, a blow that caused his death. Among his sons were Joseph Jr., a bachelor, who succeeded his father in the real estate business, founded what is now Hyde Park, and died at the advanced age of ninety-one years, and Benjamin, of whom further.

Benjamin Fellows, son of Joseph Fellows, came to Scranton, Pennsylvania, with his parents when he was two years of age and grew to manhood on a farm on the West Side. He was an agriculturist, and like the founder of the family in the United States served as justice of the peace. He died aged eighty-five years, the family trait of longevity being retained in him.

John Fellows, son of Benjamin Fellows, was born on the West Side, Scranton, Pennsylvania. He assisted in the clearing, for farm purposes, of one hundred acres of land now occupied by Hyde Park, but during most of his life was engaged in the manufacture of brick. He was politically a Republican and a strong sympathizer with all the actions of the administration in the war of the Rebellion, giving liberally of his means for the support of the Union army. His religious beliefs were in accordance with those of the Universalist faith. His death was the result of an accident suffered in 1888, while driving. An unusual sound started the horses, who gave a quick spring to the side, the carriage lurched, and in the fall Mr. Fellows sustained injuries that soon after caused his death, aged seventy-two years.

Mr. Fellows married Cynthia J., daughter of Levi and ——— (Ingles) Pierce, born in Cooperstown, New York, of which state her father was a native, but had many years since transferred his residence to Scranton, Pennsylvania. Both her father and mother were descendants of Scotch ancestry, the family having been in this country since the early days of the Massachusetts Colony. Mrs. John Fellows did not long survive her husband, her death occurring when she was seventy-three years of age. She was a woman of true nobility of Christian character, an earnest, devoted member of the Methodist Episcopal church. Mr. and Mrs. Fellows were the parents of several children, among them being: John H., of whom further; Horatio T., a member of the select council of Scranton, and an employe of the Delaware, Lackawanna & Western Railroad; George H., employed by the same company; Charles D., deceased, formerly engaged in the insurance business at Scranton; Harriet, married ——— Wolfcott, and resides in Kingston, Pennsylvania; Sarah, married ——— Carlton; Electa, married ——— Oram, and lives in Scranton.

John H. Fellows, son of John and Cynthia J. (Pierce) Fellows, was born in Scranton, Pennsylvania, July 23, 1849. Until he was fifteen years of age

he attended the district schools, then learned the trade of printer and followed it until he was twenty years of age. Winning a scholarship at Gardner's Business College, he completed a course in practical business training at that institution, and for two years was employed by the Delaware, Lackawanna & Western Railroad, leaving that service to establish in the fire insurance business as the representative of the German Fire Insurance Company of Erie. He gave this his undivided attention and by assiduous effort built up what became the largest agency in Scranton, which in 1882 he sold to Norman & Moore, who still continue it. He then began to investigate the litigation in the case of the estate of Joseph Fellows, which had been hanging in the courts for many years, and effected a settlement, securing all of the property left under the original title. He now acts as agent for the estate and has had besides real estate interests in many different parts of the country and has been a member of companies developing new sections of cities. At the present time he is president of the Browning Land Company, proprietors of land at Arlington Heights, beyond North Park; the Shawnee Land Company, incorporated in 1904, a concern which platted the Boulevard in South Wilkes-Barre; and the Ontario Land Company, capitalized originally at \$50,000, now at \$450,000, operating in Duluth, Minnesota, Spokane and Tacoma, Washington, and Atlanta, Georgia. Of this latter company, Mr. Fellows, and Harry C. Heermans, of Corning, New York, were the organizers, the main office being at Duluth.

The political record of Mr. Fellows has been commensurate with his business successes. On the People's ticket, in 1886, he was elected a member of the board of school control, but by the political strategy of the opposition was prevented from taking his seat as a member of the board. He was later elected on the Republican ticket, endorsed by the Democratic vote, and held office until 1890, when he was elected mayor as the candidate of the Republican party. For three years he held this office and in that time served the city well as a faithful official, observing the spirit as well as the letter of the oath of office. The year following the expiration of his mayoralty term, he became a candidate for the congressional election from his district and would have scored a victory had there not been evidences of the lowest form of corruption in our political system, bribery, among the one hundred and thirty delegates instructed in his favor. Mr. Fellows has been an extremely important figure in local and county politics, always as the representative of the Republican party, and has been a member of many city and county committees.

Mr. Fellows is a member of the Masonic Order, belonging to Union Lodge, No. 291, F. and A. M., of which he is past master, and Lackawanna Chapter, No. 185, R. A. M.; also has held high office in the lodge of the Independent Order of Odd Fellows, and belongs to the Encampment. His other memberships are in the Le La Lanna Tribe, Improved Order of Red Men; Hyde Park Lodge, No. 301, S. of St. G., and Washington Camp, No. 572, P. O. S. of A., of which he is treasurer.

Mr. Fellows married (first) at Meshoppen, Pennsylvania, Genevieve, daughter of Benjamin Overfield, of German descent; married (second) in Bradford county, Pennsylvania, Laura L., daughter of A. W. Gray, a dairyman. Children of first marriage: Winfield H., Raymond A., Nellie L., Lois J., Louisa A., Emma V., Alwilda G. One child of second marriage.

Respected and admired for the qualities that have gained him the prominence in Scranton affairs that has been his, Mr. Fellows is, moreover, almost universally well liked. His contact with his fellows in business and public life has given him a many-sided personality, each of remarkable bril-

liance, and this wins him many friends. Nor is his friendliness confined to the exterior, his outward cordiality being but the reflection of the warm, genial nature within.

---

### HERMAN J. WOELKERS

The growth of Scranton in the last quarter century has resulted in the bringing forward of many contracting firms, whose heads have received not only profitable remuneration but additional emolument in the way of reputation and standing as men of ability, resource and integrity. Among these the firm of Herman J. Woelkers & Company deserves special mention. Herman J. Woelkers, the head of the firm, is a practical mechanic, having served a regular term as apprentice, and for many years as a journeyman bricklayer. These years of experience eminently qualified him to enter the contracting field, and in association with capable partners he has fully realized his hopes and ambitions. He is the son of Charles Woelkers, born in Germany, and there died in 1869, a practical shoemaker. He married Elizabeth Geimberg. Children: John, Charles, Frank, Herman J., of whom further; Joseph, Elizabeth.

Herman J. Woelkers was born in Germany, February 5, 1866, and was educated in the Gelserakirchen schools. In his youth he worked for two years and a half in a bakery, coming to the United States when sixteen years of age, arriving July 3, 1882. He later came to Scranton and secured his first employment with Conrad Schraeder as water-boy, earning fifty cents daily by keeping the supply of water for the workmen clear and fresh. He then apprenticed himself to Mr. Schraeder to learn bricklaying, receiving twelve dollars monthly while so serving. After a full term as apprentice he continued with his first employer as journeyman for nineteen and a half years, becoming very expert and obtaining valuable experience. He then began contracting as head of the firm Woelkers & Beilman, later admitting Charles M. Zitzelman. The firm prospered, but the junior partner dying five years later, the original partners continued business, resuming the old firm name. After two years the present firm, Herman J. Woelkers & Company was formed, with Mr. Woelkers as manager and responsible head. They have become well-established and have erected many buildings in Scranton and vicinity. Mr. Woelkers is a member of St. Mary's German Roman Catholic Church, the St. Peter's Verein, of that church, the Leiderkranz Society, the Mannerchor, and the Benevolent and Protective Order of Elks. His residence is No. 428 Irving avenue. He married, in 1892, Frances, daughter of Albert Storr, of Scranton. Children: Alfred, Adelaide, Virgil, Frederick, Cecilia.

---

### JOHN F. DUFFY

Born in Scranton and a worker at the age of seven years, Mr. Duffy has so well fought the battle of life that he has risen to a responsible and honorable position in one of Scranton's great public utilities, the Electric Steel Railway system. He is a grandson of John (1) and a son of John (2) Duffy, both born in county Mayo, Ireland, the latter in the year 1808. He worked at farming until coming to the United States, a young man. His mother had preceded him to Scranton, where he joined her, and together they made their home until the mother's death, aged eighty-six years. John (2) Duffy married Sarah C'Donnell, and had issue: Ann, Margaret, Patrick, John F., of whom further, Arthur, Frank, and James, all deceased except Patrick, John F. and Arthur.

John F. Duffy was born on the South Side, Scranton, in 1868. He at-

tended the public schools for a short time, but at the age of seven years began working in the Central Breaker in Hyde Park as a slate picker. After a short time spent at this work, he became a farmer's boy, and until he was eighteen years of age worked on the farm in summer and in the lumber woods during the winter months. He developed a strong, healthy body, and was physically fitted to engage in coal mining, but after two months as a loader he entered the employ of the Scranton Electric Light Company, his first job being digging holes in which to place the poles supporting the wires. He rose in favor with his employers, and when the South Side line was built he was made foreman of a construction gang, under General-Engineer Parrish. When the line was completed Mr. Duffy engaged with the Suburban Electric Company in changing their overhead system to the present one. When the People's Street Railway abandoned horses as their motive power and installed the electric overhead system, Mr. Duffy was promoted to repair foreman in the company shops under Mr. Whitmore, electrical engineer for the Sprague Electric Company, the concern furnishing the equipment. He held that position for seven years, also having charge of new construction and all repair work outside of the power house. For the next five years he was in the employ of Mr. Sturgis of the Suburban Electric Light Company on Washington avenue, then entered the employ of the Scranton Street Railway Company, soon afterward being promoted to his present position, superintendent of motor equipment under Mr. Caum, a most responsible position that he is eminently qualified to fill. He has risen from the ranks and knows his business from the lowest round of the ladder, being able to view his progress with a good deal of satisfaction, knowing that he has fairly won his way. He has many friends, among whom he is held in high esteem. He is independent in political action, and a member of the Cathedral Congregation of the Roman Catholic church.

Mr. Duffy married (first) Kate, daughter of Herbert Gilligan, who bore him a daughter, Sarah. He married (second) Nellie Gallagher. Children: John, an employee of the Delaware, Lackawanna & Western Railroad Company, and Margaret.

---

#### WILLIAM GRIFFITH

William Griffith, eldest child of Andrew J. and Jemima (Sax) Griffith, and nephew of William R. Griffith, the organizer and first president of the Pennsylvania Coal Company, was born in Pittston in 1855. He was educated at the public and private schools of West Pittston and Lehigh University, whence he graduated in 1876 with the degree of Civil Engineer. He taught public school for one term at New Albany, Bradford county, Pennsylvania, and holidays and Saturdays surveyed nearby farms. In July, 1878, he went west and secured a position as transit man and later assistant engineer for the Union Pacific Railroad Company, in which interest he was engaged surveying and constructing railroads in Nebraska, Idaho, Montana, Utah and Colorado. He returned east at the Christmas season in 1880 and became division engineer for the Lehigh Valley Railroad Company, resident at Bethlehem, Pennsylvania. Two years later he became assistant on the Geological Survey of Pennsylvania in the anthracite coal regions, resident at Pottsville, Hazelton and Bernice, Pennsylvania, engaged in mapping the geology of the Schuylkill, Lehigh and Bernice coal measures, etc. During 1884-85-86 he was engaged in private engineering practice at Pittston. In 1885 he built the house at the corner of Susquehanna and Parke streets, West Pittston, which is still his residence.

During 1887 and 1888, as assistant geologist, he had in charge the completion of the geological survey of the Wyoming and Lackawanna coal fields for the state, the published result of which work comprised six volumes of maps. He subsequently opened an office in the Coal Exchange Building, Scranton, as consulting mining engineer and geologist, in which profession he is still engaged, having prepared numerous geological reports (many of which have been published) upon mining properties in all parts of the United States and in Canada, Alaska, Queen Charlotte and Vancouver Islands, Mexico and South America. Notable among his publications was an extended article on "Anthracite Coal, with Estimate of the Reserve Supply," which was published by the Bond Record, New York, and attracted widespread attention in financial and business circles. Recognized as one of the first authorities on questions relating to the economic geology of coal, he was appointed in 1892 by Governor Pattison as member of the commission to investigate and report on the problem of utilization of waste in mining of anthracite coal, and he was one of the engineers selected by the city and its advisory board to examine and report on the mining conditions under the city of Scranton, Pennsylvania. The report was published by the U. S. Bureau of Mines, Washington, D. C., which later appointed him as one of its consulting engineers.

He is a Republican in politics, though never ambitious for public office. Mr. Griffith was married in 1885 to Harriet E. Sinclair, of Trenton, New Jersey. Early in life he united with the Presbyterian church, and is now an elder in the First Presbyterian Church of West Pittston. He is member of the Wyoming Historical and Geological Society, the Franklin Institute, National Geographic Society, Engineers Society of Northeastern Pennsylvania, Mining and Metallurgical Society of America, American Institute of Mining Engineers, and American Mining Congress.

---

#### JAMES F. WARDLE

James Francis Wardle, son of Rev. Joseph Wardle and Mary Morris Wardle, was born in Bloomington, Illinois, August 17, 1867. His father was a Methodist minister and a member of Rock River conference, Illinois; his mother was a descendant of David Haggard, a soldier of the Revolution. He was educated in the public schools of Bloomington, and the Illinois Wesleyan University, from which he graduated in 1890, with the degree of A. B. He received the degree of A. M. from the same university in 1893. He was a member of the Phi Kappa Psi fraternity. In 1890, leaving college, he took a position with the large heating firm of Smead Wills & Company as a heating and ventilating engineer. He remained with this firm nine years, locating for them in Scranton in 1893. In 1899 he entered the employ of the International Correspondence Schools, as superintendent of their mailing department. In 1901 he went with the New Telephone Company as solicitor and collector. In 1904 he went into business for himself as a stock and bond broker, in which he is still engaged, with offices in the Connell building. He is prominent in the Masonic fraternity as shown in the sketches of these bodies. He is present District Deputy Grand Master of the Grand Council of Royal and Select Master Masons of Pennsylvania; secretary of Lackawanna Royal Arch Chapter, No. 185, of Scranton; and recorder of Scranton Council, No. 44, R. S. M. M. Mr. Wardle married Miss Imogene Underwood, daughter of Rev. Jonas Underwood, at Scranton, June 3, 1896. Mrs. Wardle is a member of Scranton Chapter, Daughters of the American Revolution, being descended from four ancestors who took part in the Revolutionary War. Two daughters are the fruit of their marriage: Miriam and Evelyn. Mr. and Mrs.







PHILIP ROBINSON.

Wardle and their daughters are a typical American family, and are justly popular with a multitude of friends.

---

### PHILIP ROBINSON

The Robinson family has been associated with Scranton and the Wyoming Valley for many years and has become entirely identified with the life and traditions of the region, though in origin of German stock. Its members are typical of the splendid character of the men Germany has sent to the United States from the earliest period of colonization down to the present time, men who have introduced into the cosmopolitan citizenship of this country a leaven of their own peculiar virtues, an unconquerable love of independence, and an unusual faculty for the practical affairs of life.

Philip Robinson and his three sons, of whom one was also Philip, came to the United States in 1854, and settled in Scranton, Pennsylvania, where they laid the foundations of the present large brewery which bears their name. The father met with a fatal accident on the tracks of the Delaware, Lackawanna & Western Railroad, near the town of Moscow, Pennsylvania.

The younger Philip was a lad of but thirteen years of age when he accompanied his father to this country, having been born in Lauterecken, Rheinpfalz, Bavaria, in the year 1841. He learned the trade of brewing, and was one of those to aid in the establishment of the new brewery on this side of the ocean. In 1868 he purchased the interests of the remainder of the family and became sole owner of the enterprise, operating it with great success until the time of his death in September, 1879. He was a man of much prominence in the community, active in Democratic politics, and in public affairs generally. He was a member of the Scranton Saengerbund, of the Neptune Fire Company and of Schiller Lodge, Free and Accepted Masons. He married Mina Schimpff, a daughter of Jacob Schimpff, of Bavaria, where she was born in Lauterecken, coming to this country as a child with her father, who settled in Scranton and engaged in business there, continuing for many years.

Edmund J. Robinson, son of Philip and Mina (Schimpff) Robinson, was born March 17, 1868, in Scranton, Pennsylvania. He received the elementary portion of his education in the local public schools, and after completing his studies in the same, entered the Wyoming Seminary for the more advanced courses. He later took a position in the Robinson Brewery with which his father was connected, and rose quickly through the intermediate positions to that of manager, in which capacity he took an effective part in the development of the great business. When the Robinson Company became merged in the Pennsylvania Central Brewing Company, he was retained as manager of the Mina Robinson plant. Nor was his reputation confined to the home concern or even to the brewing business at large. On the contrary he soon occupied a prominent place in the Scranton financial world and became connected with a number of important business institutions. He was a director in the Traders' National Bank of Scranton, the Lackawanna National Bank at West Seneca, New York, the president of Pomeroy Water Company, of Pomeroy, Ohio, and a director and large stockholder in many local industrial concerns. It was not by any means the case that Mr. Robinson's activities were confined to the department of business. On the contrary he was one of the most prominent citizens of Scranton in the political world, and his popularity made him a strong and effective candidate. He was a member of the

Democratic party, and a keen and intelligent observer of every passing political phase and aspect, both in local and national affairs. In 1896 he was nominated by the Democratic party as candidate for city controller, it being particularly essential that year to present the strongest available man in opposition to F. J. Widmayer. Mr. Robinson was extremely loath to enter the race, but his public spirit was successfully appealed to and he eventually consented. The campaign which followed was the memorable Ripple-Bailey struggle which ended in the victory of the Democratic ticket. Mr. Robinson was most active and aggressive during the campaign and his popularity is attested in the fact that he led the remainder of his ticket by several hundred votes, the prestige of his name being undoubtedly responsible for the election of several fellow candidates whose defeat was inevitable but for their association with him on the ticket. Three years later Mr. Robinson again ran on the Democratic ticket, this time as the nominee for city treasurer against T. R. Brooks, and once more was triumphantly elected at the polls.

The personality of Mr. Robinson was unusually attractive and winning and was doubtless quite as much the cause of his popularity as any worldly success that was his. Certain it is that it won him a host of friends whose regard was but confirmed by the sterling qualities of the man of which it was but the herald. He was very influential among the young men of the community, and it is unquestioned that his influence was always for their good. His own character possessed the manliness which is so quick to be recognized and imitated by young men, and which does not fear to challenge ridicule in what it believes to be the right. He was a man of a most democratic nature, to whose regard wealth and influence found no readier access than poverty and obscurity, a fact which was well illustrated on the occasion of his death, when all ranks and conditions mingled on a common footing to pay a final tribute to one who had been to each and all a helpful companion and a true friend. One of the most praiseworthy of his virtues was undoubtedly his affection for his family, more especially for his mother, and it is told of him upon the best authority that he never embarked upon any undertaking of importance without first consulting that most trustworthy of oracles. His death occurred June 12, 1904, and as an illustration of the universal respect paid to him, the city paid him the unusual honor of practically suspending business during the continuance of the funeral ceremonies.

Robert Robinson, son of Philip and Mina (Schimpff) Robinson, was born December 18, 1869, in Scranton, Pennsylvania. As a very young boy he developed the extraordinary energy so characteristic of him, and a precocity of intellect which, quickened by a keen interest in all the circumstances of life, soon brought him to knowledge and attainments beyond what his common school education could account for. His education was gained while attending the local public schools up to fourteen years of age when he began a business career. He was shortly offered a position as bookkeeper in the Merchants' and Mechanics' Bank, which he accepted and in which he remained for a period of three years. He then became associated with and shortly after assumed management of the Robinson Brewery Company and in this congenial atmosphere remained until the time of his death. But the sum of Mr. Robinson's activities is very far from being measured by a recountal of his business career. Indeed, his most characteristic work was done along other lines and in a quite dissimilar department of duty. His personality was one to make him eminently popular among men, and from early youth he had taken a great and intelligent interest in





*E. K. & Sons*



*Robert Robinson.*





the questions of local politics. He was a Democrat in principle, and a staunch supporter of the party, so that it happened that he had barely reached his majority when taken as the most available candidate for membership to the city council by his party, and triumphantly elected thereto. In this body he quickly established a reputation as a progressive member with the interests of the community sincerely at heart. He gave such satisfaction to his constituency that on the expiration of his term he was promptly re-elected for another two years. When his second term was but half over, however, he was nominated as a candidate for membership in the board of select councilmen, and resigned in order to accept it. To this office also he was elected and re-elected and seemed upon the threshold of a brilliant political career, when the unexpected illness seized him from which his tragic death resulted. His youth gave every promise of a successful future. The youngest member of the select council, and a reputation already established as one of the most competent men in public life, respected for his deliberate judgment and unflinching support of what that judgment told him was the right, there seemed no limit set to his possible success, and the sudden and sad event which terminated these bright hopes cast a cloud of gloom not only over his family and the large group of warm friends which he had gained, but in an unusual degree over the whole city. There were none who could fail to feel the stern gravity of the fate which thus cut off a useful life before it had even reached its prime, or to sympathize with his mother thus suddenly afflicted. His death occurred on Christmas Eve, 1898, after an illness so brief that many of his friends were not even aware of it until the notice of his death shocked them. His funeral was one of the most largely attended in the history of Scranton. Mr. Robinson was a member of many fraternal organizations, of the Nay Aug Tribe, Improved Order of Red Men; Camp No. 430, P. O. S. of A.; Electric City Council, Royal Arcanum; and Schiller Lodge, No. 345, F. and A. M., and it was the solemn and dignified funeral rites of this ancient order that were last read over his grave.

Otto J. Robinson, son of Philip and Mina (Schimpff) Robinson, was born in Scranton, Pennsylvania, June 18, 1876. He attended the public schools of the city of his birth and obtained his education in business at Wood's Business College. To say he obtained his business education in any institution of learning is a gross misstatement, inasmuch as the exceedingly broad and minute knowledge he possesses of business methods and practices has been acquired in a school which it were folly to attempt to enclose within walls, the training school of life and experience. In early life he entered the brewing business and has labored faithfully and diligently until at the present time he occupies a position as president of the Standard Brewing Company. This is a prosperous enterprise, organized in 1905, and a few weeks after having been placed in operation outgrew its plant, a performance it repeated after its size had been doubled. The company is entirely independent, unconnected with any other plant or trust, and in the direction of its business policy and the management of its varied affairs he displays business acumen of an unusually brilliant order. His other business relations are as president of the German Building and Loan Association, No. 10; director of the South Side Bank; treasurer of the Scranton Axle and Spring Company; and treasurer of the Richford Copper Company, a concern operating in Mexico. He is president of the Junger Mannerchor, belongs to the Eagle Athletic Association, and to Schiller Lodge, No. 345, F. and A. M. Mr. Robinson's political preferences are strongly Democratic, although the only part he has played in the public life of the

city has been in the capacity of school director, an office he held for ten years. He is a Presbyterian in religious faith, and belongs to the Hickory Street Church of that denomination.

Mr. Robinson married Bessie Jones. Children: Otto, Edward, Robert, Christian, Philomena, Elizabeth Bertillio. Of unimpeachable integrity in all his business relations, Mr. Robinson owes the success that he has achieved to the quality that has, above all others, characterized his career as well as that of his father, indomitable perseverance, and is reaping the reward of intelligently directed effort.

---

#### JAMES ARCHBALD (5th)

James Archbald (5th) was born at Sand Lake, New York, the temporary residence of his parents, February 13, 1838. He was a son of James and Augusta T. Archbald, and was of mixed Scotch and New England ancestry.

James Archbald (4th), father of James Archbald (5th), was of that stalwart coterie of great builders of the city of Scranton. He was born in Little Cumbray Isle, Buteshire, Scotland, March 3, 1793, and was the fourth of the same name in lineal descent. He was descended on his mother's side from the Rev. Robert Woodrow, a prominent Presbyterian divine and writer. Like Washington and Lincoln, he was self-educated. He came to Carbondale in 1828 as a civil and mining engineer, and for many years had charge of the engineering work of the Delaware & Hudson Company, and was its superintendent. Much of its difficult railroad building across the Moosic Mountains was the work of Mr. Archbald. While still connected with the Delaware & Hudson Company, he engineered and superintended the building of the gravity railroad, of the Pennsylvania Coal Company, from Hawley to Pittston, as narrated elsewhere in this work. In 1856 he went with the then new Lackawanna Railroad Company, his official relation being general agent, probably supplementing the work of Colonel George W. Scranton in building the Southern division. On the opening of the road to the Delaware river in 1857, Mr. Archbald became chief engineer, and it was largely his work that through connections were finally obtained to New York. One of the then accounted remarkable pieces of engineering was the projecting and building of the great Oxford tunnel at Oxford, New Jersey. This tunnel was then one of the longest, if not actually the longest, that had so far been built, and a peculiarity of it, quite unknown then, was that it was not a straight tunnel, but, owing to the topography of the mountain, had to be what in engineering terms is known as a "reverse curve"—i. e. a line somewhat like a horizontal letter S—and so exact had the lines been run, that when opposing gangs working from opposite ends of the tunnel, broke through and met, under the mountain, the centre line varied but three quarters of an inch. This was then regarded as a remarkable piece of engineering skill. Mr. Archbald remained chief engineer of the road fourteen years until his death. During that time the road had been practically rebuilt throughout and had been extended to Binghamton, New York, and to Oswego and Lake Ontario. In 1857 Mr. Archbald built a handsome brick residence on the northeast corner of Ridge row and Monroe avenue. It was laid out on a large lot, and was probably the finest residence place in Scranton. It still remains, known as the Archbald Place. In 1854, before coming to Scranton Mr. Archbald was located at Fort Wayne, Indiana, as vice-president and chief engineer of the Fort Wayne Railroad (since become an important branch of the Pennsylvania



James Archbald.



railroad). During his incumbency of this position he built what was then known as the "Air Line railroad" from Toledo, Ohio, to Indianapolis, and a prosperous town on the border line between the states of Ohio and Indiana was named Archbald, in his honor.

Mr. Archbald married, November 27, 1832, Augusta T. Frothingham, daughter of Major Thomas Frothingham, of the well known family of that name of Charlestown, Massachusetts. There were five children born to them—three sons and two daughters, viz.: James, Thomas, Mary, Robert Woodrow, Augusta. He died at Scranton, Pennsylvania, August 26, 1870.

Following in the footsteps of his father, James Archbald (5th) took up the engineering profession. He prepared for college in private schools at Carbondale, Pennsylvania, and at Manlius, New York. After some little experience in the field, he entered Union College, taking the engineering course, then under the brilliant direction of Professor Gillespie, and was graduated with high honors in the class of 1860. In the meantime, in 1857, his family had moved to Scranton, Pennsylvania, and there, after his graduation, Mr. Archbald became associated as civil engineer with the Delaware, Lackawanna & Western Railroad in the capacity of assistant to his father. On his father's death, in 1870, he was advanced to the chief engineership, and remained with the company in that position until 1899, giving it nearly forty years of service.

The Archbalds—father and son—were thus identified with the development of the two great coal companies of the Northern Anthracite Region, the Delaware & Hudson, and the Delaware, Lackawanna & Western, their joint association with these companies extending over a period of more than seventy years. Among the engineering achievements in which the older Archbald participated was the change of the Delaware & Hudson, in the middle fifties, to a gravity road between Carbondale and Honesdale, previous to which time the cars were drawn back and forth, from one plane to the other, on a dead level, by horses; and its extension as a locomotive road from Carbondale in the direction of Scranton. The younger man was engaged on the Delaware, Lackawanna & Western Railroad in the completion of the Van Ness Gap Tunnel at Oxford, New Jersey; the building of the Bergen Tunnel at Hoboken, and the approaches to it across the Hackensack Meadows; and the extension of the railroad from Great Bend, Pennsylvania, its previous terminus, first to Binghamton, and then to Utica and Buffalo, with the arrangement of the terminals in the latter city. The construction of the Bergen Tunnel, with its approaches, and the Buffalo extension, were under Mr. Archbald's immediate direction as chief engineer, and may be regarded as monuments to his superior skill and energy. Mr. Archbald was the official engineer appointed by the court as a member of the commission to survey and lay out the dividing line between the two counties on the formation of Lackawanna county in 1878.

In August, 1862, the darkest period of the Civil War, Mr. Archbald enlisted, and was made captain of Company I, One Hundred and Thirty-second Pennsylvania Volunteers, which was recruited from Delaware, Lackawanna & Western Railroad men; and with his company a month later he took part in the battle of South Mountain, September 14, 1862, and Antietam, September 17, 1862, being under fire at one of the most exposed and bloodiest points in that memorable battle. He served in the army until January, 1863, when he applied for and obtained a discharge, being threatened with permanent deafness due to exposure.

In 1883, without severing his relation with the Delaware, Lackawanna & Western Railroad, but being relieved of some of his more active duties,

Mr. Archbald became interested in the Barber Asphalt Paving Company, and took charge of its paving work in different sections of the country—Buffalo, New Orleans, St. Louis, Omaha and Portland. It was largely through his efforts in 1883 that Scranton entered upon a general scheme of street paving with asphalt, which did so much for the growth of the city. Later, however, he severed this connection and resumed his work with the Delaware, Lackawanna & Western Railroad, continuing with that company until 1899. After his retirement, Mr. Archbald gradually gave up his professional activities, but was called at times to important undertakings. In the winter of 1900 he had charge of a survey to connect the various independent collieries in the Lackawanna and Wyoming coal regions, with the Erie & Wyoming Railroad, looking to the building of a new anthracite coal road to tidewater. After the abandonment of that project he laid out a line of railroad across the Allegheny Mountains in West Virginia, for the Cherry River Lumber Company, to connect with the Chesapeake & Ohio Railroad. He also in 1902 made surveys for the extension of the West Virginia Central Railroad to tidewater, a project made unnecessary by the purchase of the Western Maryland. His last professional work was as chief engineer of the Mississippi Central Railroad, laying out and superintending the construction of its road across the state of Mississippi, from Natchez to Hattiesburg, with a projected extension to the Gulf at Scranton, Mississippi, with which he was occupied from 1905 to 1907, retiring finally, at the conclusion of this work, with powers unimpaired, at the age of seventy.

Mr. Archbald was a member of the Institute of Mining Engineers, and was one of the founders and the first president of the Scranton Engineers' Club. He was elected a member of the American Society of Civil Engineers, May 15, 1872. He was a director of the Third National Bank of Scranton, from its organization in 1872; a director of the Scranton Gas and Water Company; president of the Albright Coal Company, which successfully operated a mine in Pottsville, Pennsylvania; a trustee and vice-president of the Albright Memorial Library; and a director of the Pennsylvania Oral School for the instruction of deaf children. He was also for a number of years a director of the Scranton Savings Bank.

On January 25, 1865, he was married to Maria H. Albright, a daughter of the late Joseph J. Albright, general sales agent for the Delaware & Hudson Company, and his widow and six children, Colonel James Archbald, of Pottsville, Pennsylvania; Joseph A. Archbald, of Buffalo, New York; Mrs. John C. Kerr, of Englewood, New Jersey; Rev. Thomas F. Archbald; Mrs. John H. Brooks; and Miss Ruth S. Archbald, of Scranton, survive him. He is also survived by his youngest brother, United States Judge, Hon. Robert Woodrow Archbald.

In August, 1910, Mr. and Mrs. Archbald went to Europe for a three months' tour. It was purely a pleasure trip, and was to extend through Switzerland, Austria and Italy. Mr. Archbald was apparently in the best of health and spirits, but it was found that his heart was affected by the high altitudes of the Tyrol. He went to Vienna for medical examination, and was declared to have no organic infirmity but was advised not to exert himself unnecessarily. Journeying on to Venice, he seemed to improve, and spent a week in that city, but just as he was leaving, on October 4, he was stricken at the station, and died the same evening in a hospital. Thus passed away one who loved and deserved well of the profession, and who was loved and respected by all who knew him. Mr. Archbald was genial, unassuming, of simple presence, of sterling integrity, and a hater of shams. He was possessed of the highest engineering ability, especially in the field,

which was his school rather than the office. It is not necessary to dwell on his characteristics to those who had the pleasure of his acquaintance; but for those who had not, let it be recorded, that no better friend, no worthier citizen, no more active and few more able engineers, could be found.

---

### COLONEL U. G. SCHOONMAKER

The work by which Colonel U. G. Schoonmaker will be longest and best remembered in the city of Scranton, where he has achieved honorable distinction in business, civic, military and social circles, is the promotion and development of the Elmhurst region, the Scranton suburb, that through his wise planning and tireless efforts has become the ideal residential section of the Scranton vicinity. The wonderful enhancement of the natural beauties of that place by the best art of man has left little to be desired in the way of pleasant attractiveness, and to Colonel Schoonmaker is due credit not only for his vision of a suburb beautiful, but for the energy and steadfast purpose he displayed in its realization.

Colonel Schoonmaker is a native of New York, and is a member of one of the oldest Holland families of that state, descending from Captain Joachim Schoonmaker, the American founder, who came to America from Holland in the middle of the seventeenth century, settling at Kingston, Ulster county, New York, his name being among those of the fifteen farmers mentioned in the Provincial record of 1661. Captain Joachim Schoonmaker was active in the Indian wars of his time, proving his courage in battle with the aborigines and defending his property and family from their sudden attacks. His descendants bore worthily the family name in many walks of life, and have left an enviable record in the state of their adoption, also finding prominent position elsewhere, whither duty has called.

(I) Jacob Schoonmaker, grandfather of Colonel U. G. Schoonmaker, was born in Ulster county, New York, and there died. He was the proprietor of a large landed estate, part of which he had inherited and part of which he acquired through his own activity, and passed his life in its cultivation. He was a member of the force of militia that participated in the defence of Kingston during the War of 1812. He married and had children, among them Alexander, of whom further.

(II) Alexander Schoonmaker, son of Jacob Schoonmaker, was born in Marbletown, Ulster county, New York, July 26, 1820, died in Lackawanna county, Pennsylvania, in 1890. He became a lawyer in that vicinity, in 1861 moving to Kingston, the county seat, to find a larger field for the practice of his profession, and there remained until failing health made it imperative that he should abandon all legal duties. In May, 1886, he made his home at Elmhurst, then known as Dunning, his death occurring four years later. He married, April 29, 1842, Anna Elizabeth, daughter of Johannes Van Wagenen, her father a native of Ulster county, New York, one of the large land-owners of the county. The grandfather of Johannes Van Wagenen came to America from Holland, where his family originated. Children of Alexander and Anna Elizabeth (Van Wagenen) Schoonmaker: 1. J. Tyler, a commissioned officer of the Eleventh Regiment Connecticut Volunteers, served throughout the Civil War; later took contracts in the construction of the Union Pacific Railroad, subsequently going to California and engaging in ranching, now living on the Pacific Coast. 2. Colonel U. G., of whom further. 3. Jennie A., married (first) Sidney Rirl, (second) H. W. Briggs; died October 6, 1908, having passed the latter years of her life

at the home of her brother in Elmhurst; she is survived by three children by her first marriage, Sidney G., of Elmhurst, Pennsylvania, Claude, of Kingston, New York, and Addie E., of Elmhurst, Pennsylvania. 4. Ada, married William Shennen, of Clarks Green, Pennsylvania. 5. Eva A., married F. W. Harlow, editor of the Elmhurst Signal.

(III) Colonel U. G. Schoonmaker, son of Alexander Schoonmaker, was born in Marbletown, Ulster county, New York, January 31, 1845. After studying in his youth in the Kingston, New York, schools, he moved to Binghamton, New York. He was then for two years connected with the Sturrucca Hotel of the Erie Railroad at Susquehanna Depot, Pennsylvania, in the fall of 1866 coming to Scranton. Here, in partnership with his father-in-law, S. J. Reed, he purchased the Forest House, which occupied the present site of the Hotel Jermyn, afterward becoming sole owner and conducting the hotel until 1893, when he disposed of the property to John Jermyn. Mr. Schoonmaker is the owner of a tract of two hundred and fifty acres of land at Elmhurst, the Scranton suburb previously mentioned, and in the development of this tract into the leading residential district of the locality he has performed a work which he may well regard with satisfaction. Nine miles from Scranton, enjoying unusual advantages of scenery and location, the steps that have been taken to add convenience and modern improvements to its natural favors in the laying of miles of carefully graded streets and the setting out of more than eighteen thousand trees and shrubs have attracted thither many of Scranton's leading men of business and affairs. In 1883, at Colonel Schoonmaker's direction, one of the most expert landscape gardeners of this country, Mr. Webster, of Rochester, New York, mapped out a plan of lots, streets and parks, a number of the latter having been devoted exclusively to the public use. Valuable building restrictions have assured the residents of Elmhurst of estates and homes of a uniform high grade, and another pleasing feature of the region is the magnificent mountain boulevard extending from Nay Aug Falls to Elmhurst. This splendid roadway was built at a cost of more than sixty thousand dollars and affords excellent motoring advantages. Elmhurst is reached by two lines of railroad.

Politically, Colonel Schoonmaker has ever been a Republican, and has lent to that party all of his support and influence. He served on the board of commissioners of the city of Scranton under its first charter, and was prominently identified with the movement to secure the erection of Lackawanna county, a project to which he gave liberally of his time and means. He is affiliated with the Benevolent and Protective Order of Elks and the Masonic Order, in the latter society belonging to Peter Williamson Lodge, No. 323, F. and A. M., Lackawanna Chapter, No. 185, R. A. M., and Coeur de Lion Commandery, No. 17, K. T. He was one of the organizers and first president of the Masonic Veterans' Association of Northeastern Pennsylvania, and is a member of the National Geographical Society. On August 14, 1878, Colonel Schoonmaker was elected to honorary membership in Company B, Scranton City Guards, Thirteenth Regiment National Guard of Pennsylvania, and on January 12, 1880, was commissioned aide-de-camp on the staff of Governor H. M. Hoyt, with the rank of lieutenant-colonel. Colonel Schoonmaker is a member of the Military Society of Pennsylvania.

Colonel Schoonmaker married, in 1866, Louise J., daughter of Spencer J. Reed, a native of Sharon, Ohio. Mrs. Schoonmaker died July 23, 1901. Her charming personality and her gentle refinement endure in the memory of the many friends whom it was her delight to tender matchless hospitality to in her home.



## EMRYS S. JOSEPH

The life of Emrys S. Joseph was begun in Scranton under conditions anything but auspicious, and too full credit cannot be given him for the resourceful manner in which he has raised his station and for the generous degree of success he has attained. He was born in Ruabon, Denbighshire, Wales, son of Rev. Watkins B. Joseph, and grandson of John Joseph. John Joseph was a shoemaker by trade and passed his entire life in his native land, the father of: Watkins B., of whom further; John, died in Australia; Joseph, lives in Australia; Edith; Louise.

Rev. Watkins B. Joseph was born in South Wales, died in 1884, two years after coming to the United States. He was a minister of the Congregational faith. He married Mary Sibbering, who died January 3, 1913, daughter of George Sibbering, a lumber merchant of Merthyr-Tydfil, county of Glamorgan, Wales, his business now conducted by his grandson. Children of Rev. Watkins B. and Mary (Sibbering) Joseph: Annie; George, deceased; Louise, married William A. Robb, of Scranton; Gwendolyn, deceased; Agnes Mary, married David R. John, of Scranton; Edith Brownen, married Louis A. Howe, of Honesdale, Pennsylvania; Lily, married Horatius H. Keller, and resides in Scranton; Emrys S., of whom further; Blodwen May.

Emrys S. Joseph was born January 21, 1880, and when two years of age was brought to the United States by his parents, attending public school in Scranton until he was fourteen years of age. His father died when he was four years old, and as the Congregational ministry, like that of only too many other churches, was neither adequately nor promptly paid, the sum left for the support of the family was entirely insufficient to meet the daily expenses, so that Emrys S. Joseph in boyhood contributed to the family store by selling daily papers while not attending school. He obtained a position as office boy with John T. Richards, of Scranton, remaining in the employ of this gentleman and willingly performing all duties within his power until he rose to the position of bookkeeper. In 1899 he accepted a position with the Scranton Water and Gas Company at Olyphant, being in charge of the office at that place for six years, then, upon the purchase by his employers of the Carbondale Water Company, was placed in charge of the office at the latter place. In 1907, upon the death of his brother-in-law, Mr. Keller, Mr. Joseph moved to Scranton to assume charge of his insurance business, conducting the same for a year and a half and at the expiration of that time establishing in the same line independently. He was so engaged until March 1, 1911, when he was appointed special agent of the New Hampshire Fire Insurance Company, which, with others, he had previously represented, and was given general supervisory power over the agencies in Western Pennsylvania. His appointment to the service of the home office is at once a recognition of and a compliment to the excellent work he performed as an agent. His conduct of its affairs was so satisfactory that he was later made chief of the Northeastern Pennsylvania district. Recently, the New Hampshire Company, through purchase, acquired the stock of another insurance company, which will be managed by the man who has been looking after the Philadelphia district of the New Hampshire. This left a vacancy to which Mr. Joseph has been advanced. He has three times the amount of territory to look after that he had under the old arrangement, including about two-thirds of Pennsylvania, the major part of Maryland and all of Delaware. The company officials have suggested that he take up his residence at

some point that he can reach quickly from his headquarters office. Harrisburg has commended itself to him and he will remove there in the fall of 1914. Mr. Joseph's advancement has been through merit alone, a fact that is very pleasing to his many friends. Mr. Joseph is a thirty-second degree Mason, belonging to Lodge, Chapter, Consistory and Shrine, also holding membership in the Modern Woodmen of America and the Underwriters' Association of the Middle Department of Philadelphia. His church is the Presbyterian, and his convictions in political matters are Republican.

Mr. Joseph married Mary, daughter of Lewis and Margaret (Jones) Davis, of Scranton, and has one daughter, Margaret Sibbering, born October 31, 1908.

---

#### AUSTIN LA MOURE GRIFFIN

Although born in New York state, Mr. Griffin's youth and entire business life has been spent in Pennsylvania. His father, an honored minister of the Methodist Episcopal church, was stationed in various New York towns until 1872, when he was assigned to the Carbondale (Pennsylvania) Church. This may be quoted as the date of the coming to Pennsylvania.

Austin Griffin, D. D., father of Austin L. Griffin, was born in Westford, Otsego county, New York, February 1, 1836, and now, after a useful, honorable career as a minister of the Gospel, is living a retired life at Oneonta, in his native state. He was educated in the public schools and at Laurel Bank Seminary, at Deposit, New York. He made a public profession of religion in January, 1857, and was held by home influences in sympathy with the Baptist church until 1859, when he joined the Methodist Episcopal church at East Worcester, New York. Feeling divinely called to preach the Gospel, he made suitable preparation, and was granted a local preacher's license three months later, becoming in 1860 a member of the Oneida Conference. After his ordination he was assigned to the church at Schuyler Lake, New York, serving that charge during 1860 and 1861. In 1862 and 1863 he was pastor of the Laurens (New York) Church, and 1864 and 1865, in Otsego, New York, in 1866 and 1868 at Hartwick, New York. In 1869 the Otsego and Chenango districts were transferred from the Oneida to the Wyoming Conference, Rev. Griffin thus becoming a member of the latter body. In 1869 he was stationed at Milford, in 1870 and 1871 at Oneonta, coming to Pennsylvania in 1872 as pastor of the church at Carbondale, serving until 1874. An interesting coincidence must here be noted: The pioneer preacher in Carbondale was a local preacher, William Griffin. The first church, the First Methodist Episcopal Church, in Carbondale, was erected, the third church owned by the society was destroyed by fire and the present beautiful church was erected at a cost of \$40,000 and was dedicated March 8, 1903, Rev. Austin Griffin, D. D., preaching the evening sermon to the people he had served as pastor twenty-eight years earlier in their church history. From 1875 to 1877 Rev. Griffin was pastor of the Centenary Church, Binghamton, New York; 1878 and 1880, at West Pittston, Pennsylvania; and from 1861 to 1884 was presiding elder of the Wyoming district. He was then pastor of a church in Kingston, 1885 and 1886; Central Church at Wilkes-Barre, 1888 and 1890, and the Tabernacle Church at Binghamton, New York, 1891 and 1893, his last charge as pastor. From 1894 to 1896 he was financial agent for the Preachers Aid Society; and in 1897 and 1898 presiding elder of the Oneonta district, filling the same position in the Wyoming district from 1898 to 1903, having served the same district in a similar capacity from 1881 to 1884. His active life

in the ministry covered a period of thirty-five years, and was one of honor and rewarded service. He was honored by his brethren of the Conference with their highest office, presiding elder, and was their choice for delegate to the General Conference of the Church in 1884, 1892, 1896, and 1900. Syracuse University conferred upon him the degree D. D., and everywhere that his ministry called him he was loved by his people. But there is a higher degree and a greater love to be given him, that of the Master he has served so well. He married, February 1, 1858, Rosalia O. La Moure. They celebrated their golden wedding on February 1, 1908, in Oneonta, New York.

Austin La Moure Griffin, only child of Rev. Austin and Rosalia O. (La Moure) Griffin, was born in East Worcester, New York, June 24, 1859. The itinerant law of the Methodist Episcopal church then in force caused his father to change his pastorate every two years. Thus the education of the lad was obtained under a succession of new teachers, in the public schools of the towns to which his father was assigned. He also attended Wyoming Seminary, there finishing his school years. He began business life as a grocer in Pittston, continuing there four years, then sold his business and located in Wilkes-Barre, establishing a laundry. After two years there he sold out and began a similar business in Binghamton, New York, remaining there until 1898, when he disposed of his business and came to Scranton, Pennsylvania. He there became engaged in mining enterprises and was employed in various capacities until the spring of 1900, when he was appointed superintendent of the Green Ridge Coal Company, a position he now holds. Mr. Griffin is a member of the Masonic Order, holding the thirty-second degree, Ancient Accepted Scottish Rite, Keystone Consistory, Northern Jurisdiction of the United States.

Mr. Griffin married, June 24, 1883, Georgianna Slocum, educated in the public schools and St. Agnes Seminary, Albany, New York, daughter of James and Margaret A. (Thompson) Slocum, of the early Scranton pioneer family from whom the original name of the city, "Slocum's Hollow," was derived. Child, Elise R., born at Kingston, Pennsylvania, July 7, 1887, educated in the public schools, Wyoming Seminary, and the Emerson School of Oratory, Boston, Massachusetts.

---

#### WILLIAM LAWRENCE CONNELL

Prominent in the business and public life of the city of his birth, William Lawrence Connell exemplifies in his own life and character the sterling qualities that have ever characterized this eminently strong Scranton family of business and professional men. Though hardly yet in more than life's prime, he long since reached eminent position in the business world and in public life has ever been a leader of the best element of the party to which he affiliates. His terms as chief executive of Scranton were marked by careful management in all departments over which he had jurisdiction and by a devotion to the best interests of the city at large. He was twice called to the mayor's chair, each time the call was made there being especial need of a strong man to direct municipal affairs during trying periods.

William Lawrence Connell was born in Scranton, Pennsylvania, October 14, 1862, son of James and Jessie (English) Connell. He was educated in the public and private schools of Scranton and came prominently before the business world of his city as a member of the firm, Hill & Connell, furniture dealers, a firm organized in 1891. He had previously been associated with other members of the family in large coal operations, was

for years manager of the Enterprise Coal Company and in later years became president and general manager of the Green Ridge Coal Company. His interests are large in other Scranton and Pennsylvania activities, varied in character. He is president of the Lackawanna Coal and Lumber Company, president of Paint Creek Collieries Company, president of the Connell Anthracite Mining Company, president of the Union National Bank of Scranton, director of the Scranton Life Insurance Company, director of the International Text Book Company, director of the International Educational Publishing Company, these being the more important lines of business which owe much to his keen business instinct and wise executive ability. He is thoroughly representative of the wide-awake modern American business man and among the leaders he stands as one of those best qualified to lead. His public spirit is nowhere so well manifested as in the upbuilding of his native city and with the men whose efforts are so largely responsible for the greatness of Scranton he stands shoulder to shoulder.

Mr. Connell is a staunch Republican and has given much valuable time to the public service in councils, in the mayor's chair and on commissions appointed to serve the city interests. In 1893 he was elected mayor of Scranton, serving three years, and in 1902 he was again called to the head of the city affairs, serving four years. Since 1903 he has served on the board of conciliation, appointed under the provisions of the law creating the Anthracite Coal Strike Commission and is also by appointment of Governor Tener a member of the Mine Cave Commission to regulate mining under the city of Scranton. Mr. Connell is a member of Elm Park Methodist Episcopal Church, is a member of the Masonic Order and of the Independent Order of Odd Fellows, belongs to the Scranton, the Country and the Bicycle clubs of his own city and to the Philadelphia Art Club.

Mr. Connell married, January 13, 1886, Lillian Harrington, of Philadelphia. Children: 1. Jessie English, married George Houck, and resides in Philadelphia, Pennsylvania; child, Lillian Jeanette. 2. Natalie, married Rudolph S. Houck, and resides in Scranton, Pennsylvania; children: Rudolph S. Jr. and William L. 3. Lillian Jeanette, residing at home. 4. William Lawrence Jr.

---

#### MARTIN P. JUDGE

Courage, perseverance and industry are the three qualities, one might almost say virtues, that have descended to Martin P. Judge from his forefathers, all of whom proudly claimed the "Emerald Isle" as their home. Further pursuance of this narrative will show the truth and justice of the previous statement. Michael Judge was the emigrant ancestor of the family, two generations removed from the present, and leaving his home in county Mayo, Ireland, was numbered among the pioneer settlers of the Lackawanna Valley.

(11) Michael (2) Judge, son of Michael (1) Judge, was born in Lackawanna county, Pennsylvania, in 1833. From early boyhood he was employed in the mines and it was in the pursuit of this occupation, dangerous enough in the light of modern and scientific safeguards for life, but trebly dangerous in those times, when ignorance and incompetence in management were responsible for the lives of thousands, that he met death, aged thirty-eight. Honorable and upright in all his daily relations, the confidence placed in him by his fellow citizens had made him their representative in the city councils from the twentieth ward, a position he held at the time of his fatal accident. He married Bridget Marley, daughter of Martin and

Margaret (Cunningham) Marley. They became the parents of eight children, of whom two died young: Stephen, deceased; Martin P., of further mention; Maria, deceased, married Festus Muikerin; Michael, lives in Minooka, Pennsylvania; John; Thomas; Peter, all in business in the western part of the county.

(III) Martin P. Judge, son of Michael (2) and Bridget (Marley) Judge, was born in Minooka, Lackawanna county, Pennsylvania, March 16, 1863. The pressing need for contributions to the family support, caused by the tragic death of his father, deprived him of the privileges and benefit of a school education, and when only eight years of age he was employed as breaker boy. Until he was twenty-seven years of age he was engaged in mine work, daily braving the dangers that had taken his father from him, but rendered cautious and watchful by the former's untimely fate. During this time he had been constantly in attendance at night school and had made up, in point of learning at least, his lost school days. The happy, care-free hours, the childish puzzling over multiplication tables and the thousand other youthful experiences so dear to memory, could in no way be brought back. They were gone into time's vast abyss, lost treasures, never to be found. He had, in this period, so well fitted himself for business life that he accepted a position with a mercantile firm as commercial traveler, continuing in that line for about two years. He then located in Minooka and was there proprietor of a hotel, the only hotel in Minooka where the traveling public can get good meals. In 1909 he was elected recorder of deeds of Lackawanna county. He has always been a supporter of the Democratic party and was twice elected supervisor of elections in Lackawanna township, also holding the office of tax collector for one term. He assumed the duties of his present office on December 8, 1909. He is a stockholder in the Anthracite Trust Company. Mr. Judge is a member of the Catholic church. His social and fraternal affiliations are with the Fraternal Order of Eagles, the Knights of St. George, the Young Men's Institute and the Central Democratic Club.

Mr. Judge married Sarah Murray, daughter of Michael Murray, of Minooka, Pennsylvania. Children: Edward, Helen, Francis, Cyril, Maria, Anna, William, Florence.

An appreciation of Mr. Judge's rise in station could not be too laudatory or extravagant. Compelled by misfortune to lose that birthright of every child, play-time, and to early assume burdens that in the true course of events should only be borne by older shoulders; facing the problem, not only of proving his worth in competition with his fellows, but with a dismaying handicap, he resolutely set himself to the task, ceased regretting lost pleasures, educated himself, and now the fighting blood, courage, perseverance and industry of his Irish progenitors, previously mentioned, coming to the fore, he has risen from poverty and obscurity to a position from which he may regard men of responsible and honorable pursuits without raising his eyes. His is the type of true achievement, his the Americanism we so proudly vaunt.

---

#### EDWARD BAKER STURGES

Edward Baker Sturges was born in Greenfield Hill, Fairfield county, Connecticut, February 15, 1845. He is the son of the Rev. Thomas Benedict Sturges, who was for a number of years pastor of the Congregational church at Greenfield Hill. His grandfather was Joseph Porter Sturges, who was a resident of Bridgeport, Connecticut.

Mr. Sturges was a graduate of the College of New York, and studied law with J. D. Abbord, Esq., of Bridgeport, Connecticut, and was admitted to the bar of Fairfield county in 1867. His first invasion of the Keystone commonwealth was with a knapsack on his back and an Uncle Sam rifle on his shoulder, during the emergency service on the occasion of Lee's campaign into Pennsylvania, which culminated in the great battle of Gettysburg. Mr. Sturges was then but eighteen years old. He came to Scranton in 1869 and at once entered upon the practice of the law. His rare ability and resourcefulness soon gave him a leading position at the bar, and his practice rapidly grew into one of the largest and most lucrative in the city. Some of his legal triumphs have been memorable, notably his prosecution upward of one hundred violations of the liquor laws during the presidency of Colonel H. M. Boies, of the Young Men's Christian Association in 1871. W. D. Mossman was then secretary of the association. Scranton was then in its largest sense a wide-open town. Liquor men were rampant in their defiance of law. The municipal authorities, if not aiders and abettors, were supinely indifferent. Cyrus W. Hartley, a brilliant young lawyer, with Mr. Sturges, were members of the board of directors of the Young Men's Christian Association. Colonel Boies and his board of directors determined to put a stop to this rampant lawlessness, and Messrs. Sturges and Hartley were authorized to commence prosecution for that purpose. In order to be fair to the liquor men, they visited their places in person, and notified them of their purpose, and offered to desist if they would agree to obey the law. They were met with outrageous defiance, and in several instances with personal violence. Then the battle of righteousness was on. It seemed almost a hopeless undertaking, for the public was indifferent, and the obtaining of evidence was so difficult. Their perjury and subornation of perjury were freely resorted to by the liquor men, as well as the fixing of juries, so that they actually jeered and laughed at the prosecution. One of the saloon keepers said he could afford to spend a barrel of money in the fight rather than be beaten, for so profitable was his Sunday business that he carried his receipts of cash home each Sunday night in a big clothes basket. But there was courage and fight in Boies, Mossman, Sturges and Hartley, and after a strenuous year's struggle the first actual conviction was obtained, by which the liquor men learned that there actually was such a thing as law, and that these young lawyers were ready to bring down upon them its heavy hand. They then hoisted the white flag, and sued for peace. The prosecutors, abused and maltreated as they had been, were not vindictive. Their triumph was complete; the law had been vindicated. Sixty-three saloon keepers came into court, paid all costs, aggregating over twelve hundred dollars, and gave their solemn promise henceforth to obey the law to the letter, and assist in compelling others to obey it. Thereupon, on the recommendation of the court, the prosecutions were dropped.

A similar experience in 1873-76, though much more difficult because politics were made to enter into it, was the prosecution of the Democratic political boss, Frank A. Beamish, for embezzlement of the school board funds. This was one of the bitterest legal battles ever contested in any court, and was fought for the prosecution by Mr. Sturges alone. Mr. Beamish was the political head of the Democratic party—another Boss Tweed—whatever he did was sacred, and he was immune to all accounting. A more extended reference to this trial has elsewhere been made. Suffice it to say that Mr. Sturges convicted and landed his man in the penitentiary, very much to the latter's surprise and all his friends. It was not

only a great legal and moral victory, reflecting the highest credit upon Mr. Sturges, but it was another great vindication of the law. In recognition of this eminent service, and that of his lay co-worker, Mr. Robert T. Black, the citizens of Scranton at a public meeting called for the purpose, passed a series of highly commendatory resolutions, and presented each with a beautiful piece of solid silver (that to Mr. Sturges was a coffee urn) on which was engraved the following legend, "Presented to Edward B. Sturges by the Citizens of Scranton, in grateful recognition of his unselfish efforts to expose official corruption, December 25, 1876." This legal battle like that of the prosecution of the liquor case, was entirely *pro bono publico*, Mr. Sturges refusing any compensation for his services, and this has been characteristic of him. No man has done—we will not say more—no man has done as much, with the possible exception of his friend and co-worker, Colonel Boies, in the way of reform in the city, as Mr. Sturges. For forty years he has been the moving spirit, and much of the time the single handed lone fighter, for moral and civic reform in our city. Few people remember that thirty years ago Mr. Sturges, single handed and alone, attacked and cleaned the city of its gambling dens and brothels. It was through his efforts that the "Municipal Civic League" was organized, which for years hired and paid a detective to keep the city clean of those nuisances and to watch and prosecute liquor law violations, and when the League grew supine and died, Mr. Sturges, out of his own pocket, still kept the detective on duty. Those were years when Scranton was a clean city, and it was due to the sacrificing public spirit of Mr. Sturges. The public did not appreciate it, because few only knew it, and the self-abnegation of Mr. Sturges was averse to letting it be generally known.

For nearly a quarter of a century he was a director and leader of the Young Men's Christian Association, of which he was president in 1873 and 1874. As a member of the First Presbyterian Church of Scranton, he was one of the eight men who inaugurated the movement to organize the Second Presbyterian Church, of which he became a charter member and a trustee. He subsequently moved to Green Ridge and united with the Green Ridge Presbyterian Church, of which he was elected and ordained a ruling elder. Mr. and Mrs. Sturges are great travelers. They have been to about every place in the wide world worth visiting where modern transportation could carry them. This includes two trips around the world, besides an extra visit to China and Japan. They have looked upon the snow clad summits of the mighty Himalayas, and on the same journey have witnessed the benighted practices of India's worshippers of the Ganges, and other superstitions. These scenes have made them ardent supporters of Foreign Missions, to which they have been large givers. Among their benevolences is the support of a hospital in China, an Orphanage for the care of several hundred orphan waifs of India's constantly recurring famines.

Mr. Sturges has been a director of the Pennsylvania Oral School for the Deaf, a liberal contributor to the Young Women's Christian Association, and indeed to every enterprise of our city, whose object has been the uplifting and betterment of the community. In a business way he has been equally active. As previously narrated, in 1886 he built the Suburban Street Passenger Railway, and equipped it with electricity, and made it the first successful electric traction street railway on this continent, if not in the world. In his European trips, Mr. Sturges had seen the results of experiments in electric traction, for nowhere had it then gone beyond the experimental stage. He visited every town in this country where such experiments had been made, and out of his knowledge thus acquired, he had

the Suburban furnished with such improved traction equipments that it became a commercial success from the beginning. He is therefore entitled to the honor and credit of having first demonstrated the utility and practicability of electric motor traction. Mr. Sturges is not to be classed with the great inventors of the world, but rather with that other class, without whom inventions would be valueless, who demonstrate their utility and harness them into practical use, such men as Cyrus W. Field, who did not invent, but who demonstrated the utility of the ocean cable. Mr. Sturges helped to build what was known at the "Cross town" Electric Railway, now the Nay-Aug and Petersburg line. He was associated with O. S. Johnson in several coal mining enterprises, also with Edward S. Dolph in the "Dolph Coal Company," one of the largest mining concerns in the valley. In 1888 he became a stockholder in the New York, Ontario & Western Railroad, and was chiefly instrumental in inducing that company to build a branch road to New York on its main line, down into the Lackawanna Valley to Scranton, thus securing another outlet to market their coal. This company, through the Scranton Coal Company, which it owns, has become one of the heaviest shippers of coal in the valley. The branch was built in 1888 and 1889 and was opened for traffic on the first of July, 1890. He is largely interested in the Scranton Steam Pump Company and the Spencer Heater Company. Indeed there are few enterprises, either religious, civic or industrial, during his more than forty years' residence among us that Mr. Sturges has not been, either at the head of or actively identified with. He is now the principal owner of the Pine Hill Coal Company, of Pottsville, Pennsylvania, which is under the management of his son, Clarence Baker. He is also at the head of an enterprise in the state of Nevada, which is reworking the great Comstock Gold Mine, taking out and utilizing by an electric process its low grade ores which were formerly rejected. This is under the management of his son, George Sanderson.

Mr. Sturges married Marian Sanderson, daughter of Hon. George Sanderson, of Scranton, September 2, 1873. There were born to them three children: Clarence Baker; George Sanderson; Nanna S., married Francis Brooke, of Philadelphia.

---

#### WILLIAM A. SCHUNK

The father of William A. Schunk, Jacob Schunk, was the first of his branch of the family to leave the land that gave them birth, Germany. He obtained his education in his native country, and when but a youth came to the United States, accompanied by his widowed mother. He secured a position with the concern later known as the Dickson Manufacturing Company, and remained in its service until his death, thirty years later. His capacity in the company's employ was as machinist. He died in 1890, aged fifty years—his wife surviving him to the present time. Both were members of the German Presbyterian Church, and he belonged to German Lodge, Independent Order of Odd Fellows. He married Mary, daughter of George Hartman. She was a native of Germany, her parents bringing her to the United States when she was a young girl. Children: Lena, married Christian Wirth, of Scranton; John, a foreman in the American Locomotive Works at Paterson, New Jersey; Mary, married John Kiefer, of Scranton; Jacob, a foreman in the employ of the Delaware, Lackawanna & Western Railroad; William A., of further mention; Frederick C., of Scranton; Henry, of Scranton.

William A. Schunk, son of Jacob and Mary (Hartman) Schunk, was



born in Scranton, Pennsylvania, February 29, 1876. He attended the public schools of his native city, and was first employed in the draughting-room of the Dickson Locomotive Works as office boy. When the International Correspondence Schools were opening their first courses, in the beginning of the marvelous work that has attained such wonderful magnitude, he entered the class in mechanical engineering. He remained in the employ of the Dickson Company until May 4, 1896, at which time he was employed as draughtsman. Such excellent results were obtained from his first course in the Correspondence Schools that he took another, this time in civil engineering. On the previously mentioned date, when he severed his relations with the Dickson Company, he became a chainman in the office of the city engineer and has since filled all of the intermediate grades in the office, receiving his appointment as chief of the bureau in 1909. As city engineer he has been the chief promotor of the new system of sewerage lately installed, work of the most delicate nature, which he carried to a successful completion in a thoroughly masterly manner. In a profession demanding the most minute exactness he has developed the greatest accuracy even in inconsequential details, leaving no loophole to mar the efficiency of a system, or to raise doubts as to his own ability. His proficiency in his profession is the reward of hard and continuous study in the hours usually devoted by young men to recreation and amusement. But with an ambition such as his, pleasure could never be placed before an opportunity for advancement, and the end has assuredly justified the means. Aside from his professional life, Mr. Schunk is known as one of the most progressive of Scranton's citizens, always in line with and supporting all movements tending to a bettering of civic conditions. He is a member of Robert Burns Lodge, Independent Order of Odd Fellows, and Schiller Lodge, Free and Accepted Masons. As a young engineer, who has made a name in his profession upon his merits and through his own unaided efforts, Mr. Schunk is worthy of congratulation, and as a city servant with unflagging devotion to the duties of his office he is to be highly commended.

Mr. Schunk married Louise N., daughter of Dr. W. A. Nordt, of Scranton. They have one son, William Nordt. Both he and his wife are members and regular attendants of the German Presbyterian Church.

---

### J. EDWARD RUSHMORE

Originally a New York family, this line of Rushmores was introduced into Pennsylvania by John Frederick Rushmore, still a resident of the latter state, and is represented in Scranton by J. Edward Rushmore, mill superintendent of the Scranton Bolt and Nut Company. His grandfather was a doctor of dentistry in New York City, and had children: John Frederick, of whom further; Charles E., an attorney in New York City, married and has one daughter, Jean, who married Charles Patterson, of Harrisburg, Pennsylvania; Catherine, married K. E. Carpenter, of New York county; Mary Cordelia, married William Blondel, and is the mother of three children: Mary, married Harry Dolittle, Edith, married Ralph Hopwood, a resident of Asbury Park, New Jersey, and William, married and lives in Seattle, Washington.

John Frederick Rushmore, father of J. Edward Rushmore, since 1904 has resided on his farm in Waverly, Pennsylvania, having prior to that time been engaged in piano and paper dealing. He married Lillie, daughter of John B. and Susan (Roe) Valentine, of Flushing, Long Island, her father a descendant of an old Quaker family of Westbury, Long Island. Chil-

dren of John Frederick and Lillie (Valentine) Rushmore: Harold; Charlotte, died in 1880; Florence; J. Edward, of whom further.

J. Edward Rushmore was born in Brooklyn, New York, May 16, 1884. After obtaining a public school education in the institutions of New York and of Scranton, he began his business career in the employ of the Scranton Bolt and Nut Company, remaining with this concern for a period of four years. He then entered the Stroudsburg State Normal School, intending to continue through college, but the confinement of study had so impaired his health that this was deemed inadvisable, and returning to Scranton, he once more entered business with his former employers. Mr. Rushmore was raised to his present position, that of mill superintendent, in 1910, his promotion the recognition of willing, efficient and loyal service and the realization of his deep interest and concern for the welfare and prosperity of the company employing him. He competently watches over each department of the factory, being on terms of cordial friendliness with his men, who recognize in him more of the co-laborer than of the superior in office, at the same time giving due deference to his authority. The Republican party has always enlisted Mr. Rushmore's sympathy and support and he is a firm believer in the principles of that organization, while in religion he is an Episcopalian.

Mr. Rushmore married Mabel A., daughter of Eugene and Ella Henry, of Henryville, Pennsylvania, and has one daughter, Virginia, born October 7, 1910.

---

#### D. J. CAMPBELL

Journalism and politics are the two fields of effort in Scranton and Lackawanna county that have been most graced and best served by D. J. Campbell, and as proprietor of the Scranton Times, treasurer of Lackawanna county, and member of the Scranton council he has displayed the full worth of a useful career spent in manly pursuits. All of his greatest successes have been achieved in the full public view and he holds the respect of the entire community for the fair and open methods by which he has acquired prominence and prosperity.

D. J. Campbell was born in county Mayo, Ireland, and after coming to the United States settled almost immediately in Scranton, which city has been his home for the past forty-eight years. He was connected with the Scranton Times for several years and at length became proprietor of that periodical, his ownership dating from 1893 until the paper passed into the possession of its present owner, E. J. Lynett, although prior to that time he had been numbered among the men controlling the paper. Although a man of many and pressing affairs, Mr. Campbell has been ever ready to heed the call of his party, the Democratic, and as the candidate of that party in 1888 was elected to the treasurership of Lackawanna county by a large majority. In 1911 the same party proposed him for membership in the city council, and among the five councilmen elected he was the only Democrat. As a member of this body he has taken a firm stand on a platform of the rights of the people, an implacable and alert foe of special privilege, and has been particularly energetic in behalf of the laboring classes. This sympathy and co-operation with the cause of labor had its origin in years past, when Mr. Campbell was an active and prominent member of the Knights of Labor. For the past twenty years he has been engaged in the insurance business, a line in which he has been successful, and he is also a director of the Pine Brook Bank. His memberships are

in the Knights of Columbus, the Cathedral Society, the Ancient Order of Hibernians, and the John Mitchell Club.

---

### JOHN A. TOUHILL

Although a Canadian by birth, Mr. Touhill's life has been spent, since early boyhood, in the Lackawanna Valley, where he is now, at the age of seventy-seven, the honored head of the Touhill Iron Works, of Scranton, and the oldest continuous manufacturer of machinery in the Valley.

He is the son of Edward and Mary (Lane) Touhill, both natives of Ireland, who early in their married life settled in Canada, where Edward Touhill worked in the lumber woods. On coming to the United States he lived at Rochester and Geneseo, New York, for about three years, being employed on the construction of the Erie Canal. Later he came to Pennsylvania, locating at Wyalusing, but after a year there and at Camptown, moved to Pittston, where he was employed at the coal breakers.

John A. Touhill was born at Indian Village near Petersboro, Canada, August 7, 1836. He was but a boy when his parents came to Pittston, Pennsylvania, where he began business life as a breaker boy, being one of the first of the boys that were employed as slate pickers. He worked at the breaker about one year as a slate picker and also learned to run a stationary engine. In 1852 he began an apprenticeship at the machinist's trade with Jesse Williams at Pittston. In 1858 he entered the employ of Wisner & Strong, remaining with them twenty years, eighteen of which he was in charge of their shops. In 1878 they sold out to the Pittston Engine and Machine Company, Mr. Touhill continuing with the new owner for eighteen months, in the same capacity. He then started in business for himself. He conducted a successful machine building establishment at Pittston until 1905, when he came to Scranton and incorporated as the Touhill Iron Works, with plant at the corner of Hickory and Mattes avenue. The company manufactures general and mining machinery, employs about ninety men, shipping its product to Philadelphia, New York and other large distributing centers. The officials of the company are: John A. Touhill, president; Edward J. Touhill, vice-president; James P. Touhill, secretary; Charles V. Touhill, treasurer, the three latter all sons of the founder, John A. Touhill, with whom they have been associated in business all their lives. Another son, John A. (2), is foreman of the pattern shop; another son, William L., is superintendent of the plant; another son, Thomas F., is foreman of the machine shop, and still another, Leo E., is assistant foreman of the machine shop. Probably nowhere else can an establishment be found, owned, officered and managed by father and seven sons, all fully equipped by education and technical learning to capably fill their positions.

Mr. Touhill's recollection covers the entire period of the development of Pittston and Scranton. When he first came to Pittston there were no railroads, no bridges, only two old hotels, stages ran from Carbondale to Wilkes-Barre once or twice a week, furnishing the only public method of transportation. Ferries provided means of crossing the river, and they not too frequent. The site of the foundry, called the "Riverside foundry" was formerly the exact spot which Fort Pittston occupied. Mr. Touhill cast his first vote for Abraham Lincoln and has ever since acted with the Republican party. While the record of the Touhill Iron Works is most remarkable in its ownership, another fact concerning the founder and his seven sons is that not one of them has ever drunk a glass of liquor. Per-

haps this explains the success of the plant, and its continuation as an unbroken family enterprise.

John A. Touhill married, February 29, 1860, Mary, daughter of Michael Lang, who came to Pittston at an early day, bringing his daughter who was born in Ireland. Mr. and Mrs. Touhill have celebrated the golden anniversary of their wedding day, and also the fifty-fourth anniversary of the day in 1914. They are the parents of thirteen children, have thirty-five grandchildren and a number of great-grandchildren. Their children: Mary Elizabeth Fay; Edward J., born in 1864, vice-president and general manager of the Touhill Iron Works; Esther, born 1866, deceased; Ella, born in 1868, married A. E. Lynn; John A. (2), born 1870, foreman of the pattern shop at the Touhill Iron Works; William L., born 1872, superintendent of the Touhill Iron Works plant; James P., born 1874, secretary of the Touhill Iron Works; Thomas F., born 1876, foreman of the machine shop; Charles V., born 1878, treasurer of Touhill Iron Works; Hortense J., born 1880, deceased; Leo E., born in 1883, assistant foreman of the machine shop; Juliet, born in 1885, married George S. Quimby.

---

#### GEORGE WASHINGTON CLEVELAND

The Cleveland family, worthily represented in the present generation by George Washington Cleveland, a prominent business man of Scranton, traces its ancestry to an interesting line of knights, from whom various lines of American ancestors are traced, some to Moses Cleveland, who left England for the Virginia Colony in 1635, from whence the family spread into the Carolinas and the New England states.

James Edward Cleveland, father of George Washington Cleveland, was born in Sullivan county, New York, January 6, 1837, died March 31, 1906, after an active and useful life. After attaining young manhood he removed to the state of Pennsylvania, and for a time was engaged as boatman on the Morris and Essex canal. In 1869 he took up his residence in Scranton, Pennsylvania, and there engaged in the grocery business, and during the latter part of his life he was a wholesale produce dealer, his place of business being on Lackawanna avenue. He married Ellen E. Van Auken, who bore him six children, namely: James Edward Jr., Lorin Graves, William Albert, George Washington, of whom further, Ida May, Samuel Tilden.

George Washington Cleveland, son of James Edward and Ellen E. (Van Auken) Cleveland, was born in Scranton, Pennsylvania, March 19, 1882. During his youth he attended the public schools, acquiring a practical education, and this was supplemented by a course in Wood's Business College. He then entered his father's business and was thus employed until 1902, when he enlisted in the United States Marine Corps, serving for four years in various companies, seeing service in Panama, the Philippine Islands, in Japanese and Chinese waters, having thus served in almost every part of the world. In 1906 he returned to his adopted city, Scranton, and took over the present business, French dry cleaning and dyeing, his concern known as the Davis Steam Dye Works, and in 1912 he admitted his brother, Samuel Tilden, to partnership. The company is a flourishing one, ranking among the leaders in their line of business, and conducts extensive operations, drawing custom from the entire locality, their works being located at Amelia avenue and Race street, their office at No. 228 Lackawanna avenue, and they also conduct a branch of the business at No. 12 West Northampton street, Wilkes-Barre, Pennsylvania. The partners be-



*Geo. H. Cleveland.*



ing men of experience, enterprise and ability, the business has been a success from the beginning, steadily increasing in volume and importance with the passing years, and now ranks among the leading enterprises of the city. George W. Cleveland is a member of the Jr. O. C. A. M., Green Ridge Council, No. 11, and of the Order of F. and A. M., Peter Williamson Lodge, No. 323.

Mr. Cleveland married, in 1907, Verna M. Gould, daughter of Joseph A. and Amelia (Spaulding) Gould, and they are the parents of two children, Ruth and Marjorie. Mr. and Mrs. Cleveland are members of the Green Ridge Presbyterian Church.

#### ALBERT OPDYKE FREAS

The ancestry of Albert Opdyke Freas, a prominent and successful business man of the city of Scranton, is of Holland origin, the American record of the family, like that of the homeland, contributing pages of brilliance to the country's history.

(I) The great-grandfather of Albert O. Freas was Major Freas, who won his title through service in the Colonial army in the war for independence, and from him descent is through his son Andrew. Andrew Freas was a native of Easton, Pennsylvania, and later located in Briar Creek, Columbia county, and was the owner of much land, on which he raised cattle for market. There was also here located a distilling establishment, and from these two sources he massed considerable wealth, becoming known as one of the most influential and prosperous residents of the locality. The maiden name of his wife was Hess, and they were the parents of a large family: 1. Henry L., deceased; was a physician; married Amelia Messenger, and had children, Mordica, Judge Andrew M., of Wilkes-Barre, Dr. Clifton L., Frank, Robert, Harry, Bessie. 2. Dorcas, deceased; married a Mr. Hayman. 3. William Bowman, of whom further. 4. Jane, deceased; married C. F. Hill, of Hazelton, Pennsylvania, a commissioner of the United States and an insurance dealer; children: Elliott, Gertrude, Willard. 5. Fannie, deceased; married Jacob Creasy, deceased; children: Lloyd, Jennie, William, Blanche, Lizzie, Alice. 6. John, deceased; married Mary, daughter of Jacob Dietrich; children: Joseph, Lizzie, Carrie. 7. James, deceased; married Alice, daughter of Enos Adams, of Berwick, Pennsylvania; children: Enos K., Mary, Warren, Blanche, Fannie. 8. Alice, deceased; married Wesley Hill, and resides at South Bend, Indiana. 9. Harriet, married Maurice Freas; children: Seymour and Lillian. 10. Frank, deceased; married (first) a Miss Bittler, (second) Anna, daughter of Jonas Crissman; children: Harry P., Laura, Frank P., Pauline. 11. Emma, deceased; married Wilson Miller, of Lime Ridge, Pennsylvania; children: John, James, Jennie. 12. Lizzie, married Stephen Pettit; children: Oscar and Lillian. 13. Andrew Clarence, married a Miss Rothrock; children: Emily and George.

(II) William Bowman Freas, son of Andrew Freas, was born at Briar Creek, Pennsylvania, May 27, 1836, died in Orlando, Florida, in March, 1911. After obtaining a general education in the public schools he became a student in Jefferson Medical College, in Philadelphia, Pennsylvania, whence he was graduated M. D. He was for a time a medical practitioner in Columbia county, Pennsylvania, then forsaking professional in favor of business life, formed a partnership with his brothers, Henry L., John, and James, the firm of Freas Brothers, a concern which conducted triple operations, namely, a planing mill, a plant for the manufacture of agricultural imple-

ments, and general merchandise dealings. William B. Freas continued a partner in this project until 1887, when he moved to Nanticoke, Pennsylvania, there establishing in milling, a line he followed until his final retirement from business in 1896, after which he lived a leisurely life until his death. He married Jennie Kitchen, daughter of Albert Opdyke, of Berwick, Pennsylvania. Children: Albert Opdyke, of whom further; Walter, deceased; Martha, unmarried, resides in Wilkes-Barre, Pennsylvania; Ada, Wilbur, Jennie, Cora, all deceased.

(III) Albert Opdyke Freas, son of William Bowman and Jennie Kitchen (Opdyke) Freas, was born in Hazelton, Pennsylvania, September 12, 1866, and until he was eighteen years of age attended the public schools of Berwick, Pennsylvania. After spending two years in Louisburg he returned to Berwick and was associated in business with his father until 1888, four years afterward moving to Scranton and there establishing a branch of the Nanticoke milling plant, the operation of which he continues to the present time. The business is a prosperous one, ably managed and directed by Mr. Freas, whose wise judgment has raised it to a position exceeding all expectations at the time of its founding. Mr. Freas' religious belief is Baptist, while in politics he is a Democratic sympathizer. He holds membership in the Sigma Chi Fraternity, the Knights of the Maccabees, and Hiram Lodge, No. 261, F. and A. M.

Mr. Freas married Mrs. Minnie (Unangst) Follett, a widow, the mother of a son, Harold, by her first marriage.

---

#### REV. JOHN KURAS

Of the three generations of the Kuras family with whom this record deals, two have followed agricultural pursuits, and the third, John, is an ordained priest of the Roman Catholic church, being at the present time rector of St. Joseph's Church of that faith. The ancestral home is in Lithuania, where the grandfather of John Kuras was a farmer. He married Agatha Gustaidis, and had children, Elisha, of whom further, Joseph, Agatha. Elisha Kuras was born in Galine, Lithuania, Russia, and resides there at the present time. The occupation of his father is his and he owns the land that he cultivates. He married Mary Straskauckiute, and has children: John, of whom further; Patronile, Vincent, Agatha, Anthony, deceased; Frank, Mary, Joseph, Anna. John, Vincent, Frank and Joseph reside in the United States.

Rev. John Kuras was born in Galine, Lithuania, Russia, September 27, 1864. His early education was obtained in the public schools of Marianopol, and he studied theology in the seminary at Seiny. His studies completed he was ordained to the priesthood at the Cathedral, October 7, 1887, Bishop Wierzbowski officiating at the ceremony. His first charge was as assistant priest in Rajgrod, Poland, where he remained for four years, and after passing two years in the same capacity at Weigry came to the United States, and in 1894, the year of his arrival, was appointed pastor of the Lithuanian Congregation at Forest City, Pennsylvania. During the years that he labored with his people in this place he thoroughly organized the congregation, raising funds and building a new church and parsonage. Rev. Kuras was appointed rector of St. Joseph's Church of Scranton in 1907, and since that time has served the congregation in that office. He is the third pastor to have charge of St. Joseph's Church since its organization in 1892, the first having been Michael Peza, the second Anthony Kaupas. The seven years that Rev. Kuras has passed in his present position have been full of blessing





*Rev John Huras*







*Geo. W. Robertson.*

and benefit to church and people, and the unity with which they labor has been productive of excellent results.

Rev. Kuras is the spiritual director of the following societies in his church: St. Anthony's Society, St. John the Baptist Society, St. Francis Society, St. Peter's Society, St. Ann's Society, St. George's Society, St. Kaismar's Society, and the Lithuanian Catholic Alliance branches Nos. 30 and 83.

#### JOHN MELDRUM ROBERTSON

A resident of Lackawanna Valley since 1866, Mr. Robertson has there passed the nearly half century since that date, and is closely identified with coal producing companies of the district, beginning as employee and becoming an important operator. He is of Scotch birth and parentage, of old Scottish family, but has no immediate relatives in that country with the exception of his cousins, James E. Stoddart, of Howden House, and Arthur Meldrum, of Dechmont House, both in Linlithgowshire.

(I) John Robertson, grandfather of John Meldrum Robertson, was a resident of Dunning, Perthshire, Scotland. He was the father of four sons: James, David, John, Johnstone, the two latter named being bankers of Glasgow.

(II) David Robertson, father of John Meldrum Robertson, was a merchant of Glasgow, Scotland. He married Jane, daughter of John Meldrum, of Kirkcaldy, Scotland, and had children: John Meldrum, of whom further; David, for many years superintendent of the Northwestern Mining and Exchange Company, one of the bituminous coal companies of Pennsylvania, subsidiary to the Erie Railroad Company; Thomas, a mechanical engineer, who died in Scotland.

(III) John Meldrum Robertson was born in Glasgow, Scotland, March 22, 1844. He obtained his education in Scotland and England, attending Bathgate Academy, Glasgow Collegiate Academy, Elmhouse Upper Edmonton, Academy, London, and Madras College, St. Andrews. After completing his collegiate course he entered the employ of J. and T. Brown & Company, of Glasgow, continuing until 1866, when he came to the United States, and at Scranton, Pennsylvania, began his long connection with the coal interests of the valley. He filled different positions around the mines for the first two years, then entered the employ of the Delaware & Hudson Canal Company at Providence, his connection being with the coal department of that corporation. For ten years he was paymaster of the Hillside Coal and Iron Company. In 1886 he organized the Katydid Colliery, of Moosic, Pennsylvania, which he operated until 1891, in which year he admitted his brother-in-law, William Law, to a partnership. In 1904 Mr. Law retired from the firm and Mr. Robertson continued the colliery until 1908, when the coal supply became exhausted and the mine was abandoned. Very successful in business, Mr. Robertson has used his wealth generously and to gratify the finer senses. He is a well known art connoisseur, his gallery, for which he began to collect many years ago, is one of exceptional value, and one freely visited by his art loving friends, and also strangers to the owner are often found there. He is a member of the Art and Scientific societies, and possesses a fine library of valuable works. He is a member of the Moosic Presbyterian Church, and an Independent politically.

Mr. Robertson married, in 1874, Jean, daughter of Charles Law, of Archbald, Pennsylvania. Children: 1. David Meldrum, born in Scranton, July 17, 1875; now junior member of the firm of Bulford & Robertson, Wilkes-Barre, Pennsylvania. 2. Charles Law, born January 29, 1877; an attorney-at-law, of Scranton. 3. John Law, born March 21, 1882; now a member of

the firm of Robertson & Monie, mining contractors, of Moosic, Pennsylvania.  
 4. Marjorie Meldrum, born December 9, 1884; married Joseph Paul Jennings, superintendent of the Hillside Coal and Iron Company and of the Penn Coal Company. The winter residence of the family is at Moosic, and the summer residence is at Lake Carey, Pennsylvania.

Mr. Robertson is an active factor in the material welfare of his adopted town, contributing generously of his substance to every enterprise that has for its object the betterment of mankind. The home life of Mr. Robertson is an ideal one, he being a devoted husband and an affectionate father, his wife a helpmate in the truest sense of the word, and each member of the family contributing their share to the promotion of harmony, peace and happiness. The home is noted for the hospitality dispensed there, Mr. Robertson and his wife doing all in their power to make the visit of their numerous friends a delight, one to remember for a long time and a repetition of which they look forward to with pleasure. Their well stocked library and handsome art gallery are always a source of gratification to the visitor, being both instructive and pleasing. The family occupies a prominent place in the social circles of this community, winning and retaining a wide circle of friends, who estimate them at their true worth.

---

#### WILLIAM MERSHON LYNCH, M. D.

Third generation in descent from the American founder of his line, Dr. William Mershon Lynch is a Pennsylvanian by birth and activity, and for the past thirteen years has been connected with the medical profession of this state. In this calling he has become known through his connection with the Hillside Home, through his general practice, and through his incumbency of the office of coroner of Lackawanna county. Despite his professional activity, Dr. Lynch has attained prominence and popularity in public life, and at the primary election held in the spring of 1914 became the candidate of the Republican and Washington parties for the office of state senator. Of his fitness and qualifications for this important office, none who has come in contact with him can doubt, for he possesses an open and receptive mind, is ever guided by the strictest of honorable codes, and in innate ability and strength of mentality more than balances his lack of experience as a representative of the people.

(I) The grandfather of William Mershon Lynch was James Lynch, a native of the province of Ulster, Ireland, who came to the United States in 1834, residing in New York City, where he pursued the stonemason's trade. He married Mary Flood and had issue: Ellen, married a Mr. Fagan, and had one son, William, and one daughter, Mary, who married Thomas Killoyne; James C., of whom further; Mary, married John C. Jonar, and resides in South Scranton, the mother of Sadie, Ellen, Pearl, James, John, William, and Thomas.

(II) James C. Lynch, son of James and Mary (Flood) Lynch, was born in New York City, November 8, 1836, and at the age of twelve years moved to Newark, New Jersey, where he was employed as a painter in a carriage factory. He afterward returned to the city of his birth and was engaged in the carriage works of a Mr. Brewster, in 1857 coming to Pennsylvania, being for four years employed at Doddstown and later moving to Waverly, making his home in the latter place in 1860. During the Civil War he joined the Emergency Men, recruited for state defence, and after the war worked for a time in Pennsylvania, then went to Trenton, New Jersey, and after two years became foreman for the Peter Hendrick Company, painting contractors of Phila-

delphia. This line he subsequently followed independently, and after a career that included travel and residence through and in many parts of Pennsylvania, he settled in Clarks Summit, his present home. He married Louise, daughter of John U. Mershon, of Waverly, Pennsylvania, and has children: 1. Samuel E., attended Madison Academy and graduated M. D. from Jefferson Medical College, of Philadelphia, in 1887; now a practitioner of Clarks Green, Pennsylvania; married Effie Wetherby, of Scott township, Lackawanna county, Pennsylvania, and has children: William and Dorothy. 2. Charlotte, deceased; married G. U. Mengos, and was the mother of Howard, Flora, and Mildred. 3. Carrie B., a graduate, A. B., from the University of Syracuse, New York, in 1892; married George R. Barber, a druggist of Clarks Summit, Pennsylvania, and has two sons, George and John. 4. William Mershon, of whom further. 5. Frank W., married Lena, daughter of ex-Judge Falvey, of El Paso, Texas, and has one son, Thomas.

(III) Dr. William Mershon Lynch, son of James C. and Louise (Mershon) Lynch, was born in Leona, Pennsylvania, October 30, 1876. He was graduated, after a full course, in 1894, from the High School of Athens, Pennsylvania, whither his father's business had called the family, and for the two following years was employed in a printing office. In 1896 he became a clerk in the office of the county commissioners, resigning his position the following year to enter the Medico-Chirurgical College, of Philadelphia, which institution conferred upon him the degree M. D. in 1901. Soon after his graduation he became the assistant of Dr. J. J. Bellheimer, of Dickson City, Pennsylvania, and was so engaged until March 1, 1902, when he accepted the resident physician's position at the Hillside Home, there remaining until January 1, 1907. At this latter date he established in the practice of his profession independently in Old Forge, Pennsylvania, where his patronage steadily increased. In 1912 Dr. Lynch was elected coroner of Lackawanna county to succeed Dr. J. J. Salter, and in February of the following year moved to Clarks Green, his present home. Dr. Lynch is a physician learned in his profession and science, and has been uniformly successful in his treatment of cases of unusual and severe ailments that have come to his professional attention, standing high in the regard of those to whom he has ministered and in the respect of his professional associates, who recognize in him a worthy addition to Lackawanna county's medical exponents.

Dr. Lynch has ever been an enthusiastic supporter of Republican principles, and on May 19, 1914, was nominated for state senator by the combined vote of the Republican and Washington parties, a choice which the fall elections should enthusiastically confirm, for in Dr. Lynch will be found a legislator or incorruptible principles and unbiased deliberative judgment. He is popular in the locality in which he resides and bears an unblemished reputation. He has consorted much with his fellows, is of a genial and agreeable nature, and in conversation as in public speaking is easy and graceful in speech and entertaining in manner. He is a thirty-second degree Mason, belonging to lodge, chapter, commandery, consistory and shrine, and also belongs to the Patriotic Order Sons of America and the Junior Order of United American Mechanics. His church is the Presbyterian.

Dr. Lynch married Jessie A., daughter of Merritt and Mary J. (McFarland) Mead, of Clarks Green, Pennsylvania, their marriage being solemnized June 10, 1903. They are the parents of: Janet Mary and Jean Louise.

## GEORGE BYRON JERMYN

George Byron Jermyn, one of the live wires of our city, is a son of John Jermyn, whose sketch appears elsewhere. He was born in Scranton, May 9, 1862. He attended Merrill's Academic School, and graduated from Granville Military Academy, Granville, New York, in 1882, at the head of his class. He started in the oil business in 1884, and sold out to the Standard a few years later, and then went into the coal business with his father, with whose estate carrying on the business he has continued until the present time.

He is president of the Scranton Savings and Dime Bank; one of the executors of the estate of his father, John Jermyn; vice-president and treasurer of the Tintern Manor Water Company, Long Branch, New Jersey; vice-president and treasurer of the Hallstead Water Company, Hallstead, Pennsylvania; vice-president and treasurer of the Great Bend Water Company, Great Bend, Pennsylvania; and assistant treasurer and a director in the Gulf, Texas & Western Railway Company, Dallas, Texas. He is an active member of the following clubs and fraternal societies: Scranton Club, Country Club, Elks, Masons, Shrine, Knights Templars, Consistory. Mr. Jermyn married Miss Annie E. Adams, of Fair Haven, Vermont, in 1902; three children have been born to them--John, Margaret, and Ruth.

Mr. Jermyn is accounted among the ablest and most popular of the present generation of business men. He comes of excellent stock and is proving himself a worthy descendant. He is a genial, courteous gentleman and justly esteemed by all classes.

---

 REV. J. W. MALONE, J. C. D.

Rev. James W. Malone, rector of St. Peter's Cathedral, Scranton, was born in Carbondale, Pennsylvania, September 16, 1870. He received his early education in the public schools of his native town. At the age of fifteen he went to Niagara University, Niagara Falls, New York, where his literary ability during his college course merited high honors. Having finished his theological studies in Niagara University, he was ordained to the priesthood in 1895 by the late Bishop O'Hara.

His first appointment was to St. Peter's Cathedral, where as assistant rector his zeal and ability won for him many admiring friends. After a period of two years in the Cathedral, he was transferred to Susquehanna to act as assistant pastor there. Two years later he was assigned to St. Paul's, Green Ridge, to assist Rev. P. J. McManus.

His studiousness and earnestness in his work were recognized by Bishop Hoban, who suggested that he take a post-graduate course in Rome. He entered the Pontifical University, Rome, in 1899, as a student of Canon Law, and in two years graduated with distinction and received the Doctorate of Canon Law.

Upon his return to Scranton, he was appointed assistant rector of the Cathedral. Rev. James O'Reilly, the rector of the Cathedral, having been made pastor of the newly erected parish of the Nativity, South Scranton, in 1902. Dr. Malone was named as his successor in the Cathedral. He has been rector ever since. Under his prudent management the Cathedral parish has added to its possessions the beautiful Episcopal residence on Wyoming avenue, and several other properties adjacent to the Cathedral. His ability as a spiritual adviser is recognized by a large number of Catholics throughout the diocese. His candor, sincerity and kindness have inspired his acquaintances with confidence. The poor have always been his particular care, and those







Wm. L. Lawrence

in distress have always found in him a friend who will share their sorrow and lend them a helping hand. A wise counsellor, a prudent judge, a priest of deep religious convictions and the courage to live up to them, a man loyal to his friends and ready at all times to make any sacrifice for the temporal and spiritual advancement of his fellowmen, Rev. J. W. Malone has gained the love, the respect and the admiration of a wide circle of acquaintances. His interest in every movement that makes for civic progress, his active co-operation in any work of charity that comes to his notice, his wise and practical suggestions for the social betterment and moral improvement of man, have always made a deep impression upon those with whom he came in contact. But above all and first of all he is a priest who has the Catholic religion at heart, and who works faithfully to bring back souls to God, by admonishing the sinner, by correcting the erring, by encouraging the timid, and by strengthening the weak.

---

### MARTIN MALONEY

To the early settlers of Scranton, the parents of Mr. Maloney, John and Catherine Pollard Maloney, were well and favorably known for their charity and kindness to the poor and needy women and children of their neighborhood in the pioneer days, their home being located on what was then known as Division street, near the present Church of the Nativity, which occupies the site of the first Catholic Church in Scranton, and it was here that many an immigrant found with "Kitty" Maloney, as she was affectionately called, a haven of rest and received material assistance in those days of the early 50's, when the entire population of the city was less than 2,000. The father was a hard working and respected member of the community, and built the first house of importance in the section of the city known as Pittston avenue and Hickory street.

Martin Maloney was born in Ballingarry, county Tipperary, Ireland, November 11, 1848. His parents preceded him to this country and settled in Scranton in 1849, the boy, Martin, having remained with his grandparents in Ireland until 1854, when he joined his parents in this country, endowed with abounding health and the energy characteristic of the sons of the Emerald Isle. Mr. Maloney attended the public schools of the city until he was twelve years of age, when he went to work in the coal mines. At fourteen he began an apprenticeship as tinsmith, coppersmith, plumber and gas fitter. He graduated later in the school of experience, the *alma mater* of so many successful Americans who accomplish things. Mr. Maloney started in business for himself August 5, 1868, when not quite twenty. He proved a hustler from the start, displaying at this early age such painstaking thoroughness in everything he undertook that there still exists in Scranton to-day evidence of the substantial character of his work. It was this characteristic which was mainly responsible for the greater successes which he achieved later on.

In 1874 he organized and built the Hyde Park Gas Plant—the nucleus of the present extensive system which furnishes the entire valley with gas. From that time it was forward march at a rapid pace for him; to-day he has many varied and growing interests in Scranton, with the growth and prosperity of which he is so closely identified, having faith in the future of the city, born of faith in its people, even though he has not permanently resided here for many years.

In 1875 Mr. Maloney organized the Maloney Gas & Manufacturing Company, a corporation which was destined to extend its activities far beyond the boundaries of Scranton. At this period he became acquainted with Mr.

Henry H. Rogers, of Standard Oil fame, who evinced a great deal of interest in the young man's plans, which were original in so far as they applied to a new system of lighting by the use of naphtha, than in its crude form and considered a dangerous by-product around an oil refinery. Mr. Maloney met with many obstacles and difficulties which he overcame with his accustomed vigor and determination, and within ten years one hundred and thirty-seven towns and cities were under contract and lighted under the Maloney Lighting System. The energy of the man who managed this undertaking can be appreciated.

Mr. Maloney was one of the founders of the United Gas Improvement Company, of Philadelphia, a corporation which now controls hundreds of gas and electric properties throughout the United States. He is also connected with the management of gas, water, oil, electric power and other public utilities corporations too numerous to mention. His career is so well known throughout the country as to make enumeration unnecessary.

This busy man of vast affairs found time for other matters. He was married, in December, 1868, at Scranton, Pennsylvania, to Margaret A. Hewittson, seven children being born to the union, Margaret Maloney Ritchie and Helen Maloney Osborn being the only two surviving. The faithful wife, Margaret, has been his friend and counsellor and has assisted in his generous charities from the first. In recognition of his many good works, and his deeply religious temperament, the great Pope Leo XIII, in 1902, created him a Papal marquis. In 1904, Pope Pius X conferred upon Mr. Maloney the title of Cameriere Segreto di Spada e di Cappa di S. Santita, making him a member of his household, in further recognition of his many benefactions to the Catholic church and other charities. This title has been confirmed by the present Pontiff, Benedict XV. Among his many charities and one that is especially near and dear to him, is the Maloney Home for the Aged, erected in memory of his father and mother. This institution is non-sectarian and domiciles more than one hundred and twenty-five inmates, no creed being necessary to obtain shelter under the roof of the Maloney Home. The beautiful Memorial Church of St. Catherine, erected at the summer home of Mr. Maloney at Spring Lake, New Jersey, in memory of his deceased daughter, Catherine, is another of his benefactions in which he takes particular pride.

Mr. Maloney now makes his permanent home in Philadelphia, residing on Logan Square. He is a member of the Union League, Academy of Fine Arts, Historical Society of Pennsylvania, Catholic and City Clubs of Philadelphia, the Catholic Club of New York, the Scranton City Club and the Scranton Country Club. But his favorite resort is his seashore home at Spring Lake Beach, New Jersey, beautiful "Ballingarry." In this picturesque villa he has realized the dream of his youth and has named it for the ancestral home in Ireland. It is there that Mr. Maloney loves to entertain his friends and to plan how he may further help to bring sunshine into the lives of the unfortunates.

---

#### PHILIP ROSWELL PHILLIPS

Mr. Phillips was born in Johnstown, Pennsylvania, November 24, 1884, son of Rev. David C. and Mary Evans Phillips. He came to Scranton with his parents in 1889, after the Johnstown flood. He graduated from the Scranton High School in 1902, and from Lafayette College, Easton, in 1906. He began newspaper work in 1901 on the Scranton Truth; joined the staff of the Scranton Republican in 1906, continuing until February 1, 1910, when the Republican was merged with the Tribune-Republican; continued on the Tribune-Republican until June 21, 1913, when in company with other members of the staff, he followed Robert D. Towne, joining with him in founding

Scranton Daily News. He is a member of Peter Williamson Lodge, No. 323, F. and A. M.; of the Newswriters Union, Scranton; the Pennsylvania Legislative Correspondents Association, and the Sigma Nu Fraternity. He is a member of the board of directors of the Daily News Company.

---

RT. REV. MICHAEL J. HOBAN

Rt. Rev. Michael John Hoban, Bishop of Scranton, was born June 6, 1853, at Waterloo, New Jersey, where his father was building a section of the Morris & Essex Railroad. About one month after his birth, his parents went back to Hawley, Pennsylvania, where his father owned some property and had obtained the contract to transfer all the coal carried by the Pennsylvania Coal Company during the fall and winter from its mines in Luzerne county and stacked in a huge pile, awaiting transshipment on the opening of the Delaware & Hudson canal in the spring.

Taught by his mother to read and spell, he went to private schools until he was fourteen years old, when he went to St. Francis Xavier's College, New York City, for one year, thence to Holy Cross College, Worcester, Massachusetts, where he spent three years. After two years and a half at home helping his widowed mother, he attended St. John's College, Fordham, during the spring of 1874. In September of that year he entered St. Charles' Seminary, Philadelphia, as an ecclesiastical student for the Diocese of Scranton. In September, 1875, recommended by the faculty of the Seminary, he was sent by Rt. Rev. Bishop O'Hara to the American College, Rome, where he spent four years and eight months. He was ordained priest in the church of St. John Lateran, Rome, by H. E. Cardinal Monaco La Valletta, on May 22, 1880. After two months of travel in Europe he returned home and was appointed as assistant to the Rev. Dr. Charles F. Kelly, in Towanda. In 1882 he was transferred to Pittston to assist V. Rev. John Finnen, V. G., and in 1885 he received his first appointment as pastor of St. John's Church, Troy. In 1887 he was appointed to organize the parish of St. Leo, Ashley, near Wilkes-Barre. There he built a large brick church and brick priests' house, and remained until he was obliged to take up his residence in Scranton. His name having been placed on the lists of both priests and bishops, he was selected by His Holiness, Leo Thirteenth, to be Bishop of Mali, and coadjutor to Bishop O'Hara, with the right of succession. Appointed by Papal brief, dated February 1, 1896, he was consecrated by Cardinal Satolli in St. Peter's Cathedral, Scranton, on March 22. On the death of the Venerable Bishop O'Hara, February 3, 1899, he succeeded as Bishop of Scranton, where he has resided ever since. He is president of St. Patrick's Orphan Asylum, honorary president of St. Joseph's Infant Asylum, director of State Hospital, Scranton Public Library, Pennsylvania Oral School, West Mountain Sanatorium and also honorary president of the Catholic Choral Club and the Catholic Women's Club.

In 1896, when he was consecrated Bishop, there were 119 priests in the Diocese of Scranton; in 1914 there are 255. Then there were 11 churches in the city of Scranton; now there are 23, attended by ten different nationalities, not including the Ruthenians. During the interval several new churches have been built,—Holy Rosary, Nativity, St. John Baptist, St. John Evangelist, St. Ann, and also Mt. St. Mary's Seminary and St. Ann's Passionist Monastery and St. Joseph's Infant Asylum, all in the city of Scranton.



# INDEX





# ADDENDA AND ERRATA

In some instances Ezra S. Griffin Post and Ezra S. Griffin Camp have been erroneously given as Ezra S. Griffith Post and Camp.

Sanderson, p. 257. At the present time (1914) Charles Dudley Sanderson is president of the New England Society of Northeastern Pennsylvania, elected November 12, 1914.

## INDEX

Note.—Where a star (\*) appears against a name, see Addenda.

- Allen, Edward, 328  
 Gabriel, 328  
 George, 170  
 George W. B., 389  
 Jabez, 389  
 Robert W., 170, 171  
 William E., 328  
 Alworth, Henry S., 135  
 Milton S., 136  
 Amerman, Edwin C., 246  
 Jesse C., 246  
 Lemuel, 119  
 Ralph A., 118, 119  
 Ames, Erasmus D., 161, 162  
 John H., 162  
 Joseph, 161  
 Andres, Charles S., 637  
 John, 637  
 Matthew, 637  
 Ansley, Brinson, 32  
 Joseph, 32  
 Mary C., 33  
 Archbald, James (4th) 660  
 James (5th) 660  
 Ashley, Hayden H., 579,  
 580  
 Nehemiah B., 579  
 Rollin T., 579  
 Atherton, Bicknell B., 490,  
 521  
 Dudley R., 490, 491  
 Fred B., 521  
 Henry F., 492  
 John R., 492  
 Baker, Alfred M., 425  
 Alfred M., Jr., 425  
 Bambach, Jacob, 647  
 Jacob D., 647  
 Bartecchi, Domenick, 639  
 John, 639  
 Battenberg, C. Augustus,  
 128  
 Charles C., 128  
 Bauer, Charles, 301  
 Josiah, 301  
 Robert J., 301  
 Beemer, Elias, 497  
 Floyd D., 497  
 George, 497  
 Beers, Elias T., 252  
 Fred E., 251, 252  
 Ulysses F., 252  
 Belden, James J., 479  
 James M., 479  
 Belin, F. Lamnot, 55  
 Henry, 53  
 John, 53  
 Paul B., 54  
 Benedict, David, 356  
 Frank S., 355  
 Katherine S., 356  
 Benore, John, 382  
 Bessmer, Christopher D.,  
 448  
 Jacob, 448  
 Beyea, Edwin M., 396  
 Henry, 396  
 Bianca, Giuseppe, 602  
 Joseph, 603  
 Bishop, Henry, 437  
 Marcus K., 437  
 Black, Caroline A., 176  
 Robert T., 175  
 Blau, Adolf, 438  
 Boies, David, 5  
 Henry M., 1  
 Boland, Christopher G.,  
 624  
 James, 625  
 Bosak, Michael, 584  
 Brader, Herbert E., 576,  
 577  
 Breck, George L., 272  
 Samuel, 576  
 William, 272  
 Brennan, Edward C., 417  
 John J., 417  
 Brewster, Eldad, 72  
 Frederick D., 72, 73  
 Horace, 72  
 James, 72  
 Briggs, Harold S., 410, 411  
 William P., 411  
 Brooks, John H., 37  
 Reese G., 36  
 Brown, George C., 353  
 Milton R., 353  
 Bryden, Alexander, 380,  
 388  
 Andrew, 387  
 Archibald L., 388  
 James Y., 389  
 Bunnell, Elijah, 102  
 Gershom, 102  
 James, 102  
 Joseph, 102  
 Lewis M., 221  
 Martin, 221  
 Miles M., 221  
 Willard M., 102  
 William, 101, 102  
 Burke, Edward A., 109  
 Michael J., 109  
 Burnett, John, 470  
 Kenneth R., 470, 471  
 Burr, Frank E., 289  
 Isaac, 288  
 James E., 288  
 Washington, 289  
 Callender, Newell, 336  
 Samuel, 336  
 Samuel N., 336  
 Calpin, Patrick, 384  
 Patrick F., 384  
 Camarca, Vito, 508  
 Campbell, D. J., 674  
 Duncan T., 632  
 Carlucci, Carlo, 491  
 Peter F., 491  
 Carney, John, 397  
 Carr, Henry J., 254  
 Carter, Daniel, 104  
 Griswold, 104  
 Joseph, 194  
 Lewis B., 103, 104  
 Marvin P., 198  
 Phineas, 195  
 Pulaski, 194, 195  
 Pulaski P., 198  
 Thomas, 194  
 Casey, Andrew J., 455  
 James T., 454  
 Patrick J., 454  
 Timothy, 454  
 Cassese, Charles J., 601  
 Joseph A., 601

- Catlin, George H., 623  
 Caum, Edward L., 57  
     Frank, 57  
 Cawley, Patrick H., 396  
     Thomas F., 70  
     William, 70  
 Chandler, George, 541  
     Louis B., 542  
     William, 542  
     William H., 542  
 Chapman, Charles I. A., 346  
     Isaac A., 346  
     Maxwell, 346  
 Clancy, Phinny D., 333  
 Clark, George R., 534  
     James, 632  
     James R., 534  
     Patrick J., 632  
     William, 534  
 Clarke, Edward M., 73  
     George W., 73  
     Matthew W., 73  
 Cleveland, George W., 676  
     James E., 676  
 Close, Arthur W., 407  
     J. Edward, 407  
 Coar, Matthew A., 452, 453  
 Cobb, Mount, 361  
     Roy E., 361, 362  
     William J., 361  
 Collins, Bernard, 471  
     Thomas, 471  
     William H., 471  
 Cominelli, Angelo, 476  
 Conger, Stephen M., 332  
     William H., 332  
 Connell, Alexander, 543  
     Alexander J., 529, 530  
     Alfred E., 503  
     Charles, 543  
     Charles R., 502  
     Ezra H., 503  
     Frank H., 56, 57  
     Harry A., 627  
     James, 498, 529  
     James L., 501  
     William, 498  
     William L., 667  
     William P., 56  
 Connerton, Edward, 489  
     Edward J., 489  
 Connolly, Bernard P., 129  
 Conrad, Andrew, 605  
     Charles C., 606  
     Edward, 607  
     Louis, 607  
     Otto R., 608  
     William, 606  
 Corley, Andrew, 427  
     John T., 427  
 Cornell, Arthur W., 490  
     Jerome B., 490  
 Corser, John B., 238  
     John F., 238  
 Costello, Michael J., 512  
     Thomas, 628  
     William J., 628  
 Crowdry, Nathaniel A., 76  
     Nathaniel H., 76  
 Crawford, Huldah A., 518  
     James L., 516  
 Cross, Albert J., 206  
     Friend A., 206  
 Cresswell, Charles H., 587  
     Herbert, 587  
 Curt, Joseph, 461  
     Joseph J. Jr., 461  
 Cusick, Owen, 582  
     Patrick F., 582, 583  
 Daniel, Frank J., 268  
 Davidson, Walter H., 404  
 Davies, John W., 213  
     William J., 213  
     William R., 213  
 Davis, Abner, 460  
     Edward H., 460  
     Evan P., 85  
     James E., 84, 85  
     William J., 150  
 Dawson, Hugh A., 123  
     William, 123  
 Dean, Arthur D., 41  
     Isaac, 40  
     Walter, 40  
 Deantonio, Emilio, 155  
 De Blasiis, Appio C., 603  
     Nicholas, 603  
 Deckelnick, Nicholas, 580  
     William, 580, 581  
 Dempsey, James, 648  
     John T., 619  
     Michael J., 648  
     Patrick, 619  
 Derry, Alfred L., 293, 294  
     John, 293  
 Deubler, Henry, 360  
     Marcus L., 360  
 Devereaux, Walter J., 385  
 De Witt, Isaac, 305  
     Osee D., 305  
 Dickson, George L., 22, 23  
     James, 22  
 Dimmick, Eber, 488  
     Edward, 488  
     George B., 488  
     J. Benjamin, 185, 187  
     Samuel E., 186  
     Thomas, 186  
 Dolph, Ernest W., 493  
     Isaac, 493  
     Samuel, 493  
 Donahoe, Thomas A., 547  
 Donahue, Peter F., 636  
 Doud, Charles H., 166  
     Ebenezer, 166  
     Erastus S., 165, 167  
     Galen, 166  
     Thomas, 166  
 Douglas, J. Nelson, 543, 544  
     Samuel, 372  
     Samuel W., 543  
     William, 372  
     William J., 372  
 Downing, Andrew H., 418  
     Thomas, 418  
 Doyle, James B., 341  
     Michael, 341  
 Duckworth, John, 415  
     John A., 415  
     John S., 415  
 Duffy, John, 654  
     John F., 654  
     Michael, 597  
     Patrick F., 597  
 Dunn, Arthur, 524, 525  
     Isaac B., 18, 525  
     James, 17, 524  
     John, 16  
     John T., 16, 18  
     William, 16, 17, 524  
 Dusenbury, John H., 576  
     John W., 576  
 Eberhardt, Otto L., 163  
 Edwards, Henry M., 367  
     John M., 367  
     John R., 368  
 Eisele, Edward, 122  
     John F., 122  
 Emery, Frederick H., 172  
 Evans, Daniel W., 370  
     Elias E., 152  
     Jennie L., 151  
     Morgan L., 370  
     Reese J., 152  
 Eynon, Albert B., 586  
     Benjamin G., 586  
     George F., 433  
     Thomas, 433, 586  
     Thomas F., 433  
 Fahringer, Jay M., 429  
     Jeremiah, 429  
 Farr, John R., 504  
     Fellows, Benjamin, 652  
     John, 652  
     John H., 652  
 Felton, George, 445  
     Peter, 445  
 Fenstermacher, Edgar A., 443, 444  
     Michael W., 444  
     William, 443  
 Ferber, Augustus C., 90  
     Henry F., 90  
 Fine, Andrew M., 487  
     Martin L., 487  
 Finkelstein, Isador, 590  
 Fish, Edmond, 299  
     John B., 299  
     Laura T., 300  
 Flannery, John, 629  
 Fordham, John R., 380  
 Foster, Clement S., 258  
     Rufus J., 258  
 Frank, Jacob M., 590  
     Louis, 590  
 Freas, Albert O., 677, 678  
     Andrew, 677

- Frink, Abraham L., 472  
Orrin, 472
- Fuhrman, Jacob S., 413  
Samuel J., 413
- Fuller, Arthur C., 64  
Bartley, 561  
Charles, 308  
Charles A., 64  
Collins, 562  
Edward, 308  
Edward C., 308  
Edward L., 308, 309  
Mortimer B., 311  
Peter, 561
- Fulton, Annie C., 501
- Garrett, Daniel, 486  
Francis, 486  
John N., 486  
John S., 486, 487  
Joseph, 486  
Wait, 486
- Garvey, James B., 349
- Gates, Alpheus W., 275  
Lowell M., 275, 276
- Gaynor, James L., 548  
Patrick J., 548
- Gilhoot, Timothy, 443  
William E., 443
- Gilligan, John, 359  
John J., 359
- Gilroy, Joseph F., 459
- Gleason, Ronald P., 43  
Thomas, 43
- Gloor, Ernest, 227  
John, 227
- Goldsmith, Morris, 469  
Rudolph M., 469
- Gregory, Marion A., 483  
Ralph A., 482, 483
- Griffin, Austin, 666  
Austin L., 666, 667
- Griffith, Andrew J., 655  
William, 655
- Guernsey, James W., 250  
Joseph U., 259  
Levi B., 259
- Gunster, Charles W., 127  
Henry J., 127  
Joseph H., 126
- Gurisatti, Dominick, 485  
Victor, 485
- Gutheinz, Alfred, 481
- Haak, Ezra J., 647  
George E., 646, 647
- Haas, Daniel, 160  
Peter W., 160
- Hackett, Richard M., 344  
William T., 344
- Hagen, Henry, 331, 572  
Herman, 473  
William H., 331
- Haggerty, Daniel, 513  
William, 513
- Haines, Reuben, 559  
Winfield S., 559
- Hall, Byron G., 116  
Herschel J., 115, 116  
Jabez G., 116
- Hampel, Charles, 570  
Peter, 570
- Hand, Alfred, 7, 8  
David B., 229  
Ezra, 8  
John, 7  
Nathan, 229  
Robert, 229
- Hannon, James A., 424  
James J., 424
- Hanyen, Cornelius, 528  
Fred C., 528
- Harrington, David C., 44  
James, 44  
William, 44
- Harris, John H., 374  
Reese H., 374, 375
- Harrison, James, 402  
Thomas F., 402, 403
- Hartzell, Frederick V., 457  
Hendrick, 457
- Harvey, James, 325  
John A., 325  
William A., 325, 326
- Healy, Louis W., 264  
Samuel, 264
- Hendrickson, Forrest F., 249  
John, 249
- Henkelman, Max F., 482
- Henwood, Charles, 219  
Charles P., 219  
Julia A., 220  
Richard, 78  
Walter L., 78, 79
- Hessinger, Henry, 91, 574  
Margaret, 575  
Theodore, 91, 574  
William C., 91
- Hicks, Benjamin B., 116, 117  
Mahlon, 116  
Mordecai, 116
- Higham, Herbert R., 475  
William, 475
- Hill, Andrew J., 533  
Jacob, 533  
J. Foster, 533  
Walter L., 494
- Himes, Philip, 225  
Samuel, 224, 225
- Hitchcock, Edwin S., 25  
Frederick L., 24, 25, 26  
Peter, 24
- Hoban, Rt. Rev. M. J., 685
- Horan, Patrick, 399  
Patrick J., 399
- Hornbaker, George W., 399
- Horton, John M., 223  
Leonard M., 223
- Houck, John W., 233  
Samuel, 234  
William L., 233, 234
- Howarth, John W., 149
- Howe, Abraham S., 92  
Phineas, 92  
Thomas B., 92
- Howell, Esdras, 651  
John W., 651  
Louis, 651
- Hower, George F., 266  
Jacob J., 266
- Howley, Michael T., 561  
Peter F., 561
- Huber, Robert L., 482
- Hughes, Evan D., 424  
John, 400  
John G., 424, 425  
Thomas J., 400
- Hunt, Alfred T., 449, 441  
George, 441  
James M., 441
- Inglis, Frank, 148  
J. Scott, 148  
William W., 403
- Intocia, Gaeton, 598  
Jennar, 598
- Jadwin, Charles P., 635
- James, David, 571  
Thomas D., 571, 572
- Jeffrey, Joseph, 82, 83  
William, 83
- Jenkins, David, 420  
Jabez, 468  
John L., 420  
Thomas, 420  
William O., 468
- Jennings, Hugh, 480  
James, 480
- Jermyn, Edmund B., 281  
Frank H., 280  
George B., 682  
John, 277  
Joseph J., 279  
Rollo G., 281  
Walter M., 280
- Jones, Cyrus D., 95  
Daniel, 368, 569  
Evan S. Jr., 495, 496  
George L., 560, 570  
Harry J., 555  
Henry D., 369  
John, 95, 555  
John B., 453  
John D., 420  
John R., 554  
Joseph H., 453, 454  
Meredith, 559  
Randolph, 558  
Robert P., 551  
Roderick, 569  
Seymour E., 557, 558  
Thomas M., 559  
Walter H., 368, 369  
William, 95, 557  
William R., 554
- Jordan, James D., 436  
Richard, 436  
Thomas H., 436

- Joseph, Emrys S., 665  
 Watkins B., 665
- Judge, Martin P., 668, 669  
 Michael, 668
- Kays, Martin R., 380  
 Mary A. F., 380
- Keast, John, 405  
 John H., 405
- Keffer, Monroe C., 435  
 Roscoe H., 434, 435
- Kehrl, Andrew, 585  
 Caspar, 585  
 Henry, 585
- Keller, Daniel, 60  
 Joseph, 58, 59  
 Joseph F., 119, 120  
 Luther, 58, 60  
 Peter, 59  
 Theodore, 119, 120
- Kelly, Ellsworth, 124  
 James, 124  
 John, 110  
 John H., 124  
 John P., 110
- Kemmerer, William, 338  
 Willis A., 338
- Kennedy, Amelia M., 197  
 James S., 192  
 John, 191  
 Lucius C., 191, 194  
 Thomas, 191  
 William D., 193
- Kiefer, Asa E., 537, 538  
 Peter, 537  
 Samuel, 537
- Kingsbury, Ebenezer, 142  
 Edward P., 142
- Kirkpatrick, Alexander, 538,  
 539  
 Charles L., 539  
 Charles W., 538, 539  
 David, 539  
 Jacob, 539
- Kizer, Abram, 600  
 Alton F., 600  
 Jacob E., 600  
 John D., 600
- Knapp, Harry A., 49  
 Peter, 49
- Knight, Benjamin, 319  
 Jeremiah D., 319  
 Myron S., 319, 320  
 Nicholas, 319
- Koehler, Henry T., 504
- Kolb, Edward O., 147  
 John G., 147
- Kramer, Albert N., 435  
 L. H., 436  
 Nathan, 435  
 Samuel N., 436
- Kuras, Rev. John, 678
- Lalley, Michael, 458  
 Peter F., 458, 459
- Lansing, James A., 111, 112  
 William J., 112
- Larkin, Joseph F., 85  
 Madison F., 87
- Lathrop, Benjamin L., 476  
 Edward F., 476  
 John, 476
- Law, Archibald, 182  
 Archibald F., 182, 183  
 Charles, 183
- Lawall, Allen J., 577  
 Elmer H., 577
- Lawrence, Allan, 339  
 John, 339  
 Lawrens, 156  
 Milton, 339  
 Thomas, 157, 158  
 Walter L., 156, 159
- Legambi, James, 605  
 Pietro, 604  
 Vincenzo, 604
- Le Monte, Arthur C., 483  
 Wellington, 484  
 William, 484
- Lentes, Frederick C. W.,  
 546  
 John, 544, 545
- Lettieri, Ernesto M., 603,  
 604  
 Joseph M., 603
- Levy, Newton B., 589
- Lewis, John D., 290  
 William J., 290  
 William J. Jr., 292  
 William R., 237, 238
- Liming, John, 573  
 William S., 573
- Lindsay, Charles H., 174  
 James, 174
- Linen, George, 38  
 James A., 37, 38
- Logan, Harry V. N., 535  
 Samuel C., 535
- Lohmann, George, 549  
 John, 549
- Loughran, John J., 519
- Lowry, George, 297  
 Holloway, 297  
 James W., 297  
 John, 296  
 Milton W., 298
- Lucas, George J., 199
- Lutsey, Edward, 324  
 John, 324  
 John L., 323, 324  
 William, 324
- Lynch, Austin, 614  
 Bartholomew J., 615  
 Frank M., 615  
 James C., 680  
 James J., 614  
 William M., 680, 681
- Lynett, Edward J., 107, 108  
 William, 107
- McAmilty, James S., 504
- McClave, William, 269
- McConnell, John G., 334,  
 335  
 Joseph, 333  
 Walter A., 333
- McCordle, John, 401  
 Thomas, 401
- McDonald, Michael E., 522
- McGee, Patrick, 553  
 William F., 552
- McGinley, Michael A., 130
- McGuire, John F., 393
- McLoughlin, James, 595  
 Thomas H., 595
- McNulty, James, 406  
 Thomas J., 406
- Madden, Harry T., 556  
 Thomas O., 556
- Major, Abel G., 634  
 A. Lesley, 634  
 Thomas, 634  
 William, 634
- Malone, Rev. J. W., 682
- Maloney, Martin, 683
- Manchester, Albert B., 566  
 Henry C., 566
- Manley, Patrick D., 394
- Martin, Michael, 243  
 Michael J., 243, 244  
 Patrick, 243
- Masucci, Charles A., 547,  
 548  
 John, 558  
 Peter, 547  
 Pietre, 558
- Matthews, Charles W., 71  
 Frank V., 395  
 Richard J., 117, 118  
 Robert, 71, 118  
 Sidney, 395  
 William, 71
- Maxey, George W., 302
- May, Lewis, 34  
 W. A., 34
- Mead, Thomas H., 430, 431  
 William, 430
- Mears, Eva V., 322  
 John A., 321  
 John F., 321, 322  
 Sidney C., 321
- Megargee, Francis O., 121  
 Jacob, 121  
 Sylvester J., 121
- Melley, Rev. Edward J., 637
- Melody, John, 408, 409
- Meredith, Thomas, 318  
 Thomas G., 318  
 William S., 318
- Merrifield, Edward, 228
- Mersereau, Charles L., 364,  
 365  
 John, 364  
 Joshua, 365
- Miller, C. August, 451  
 Charles F., 286  
 Gustav A., 169, 170  
 Irvin C., 407  
 Maurice T., 144, 145  
 Michael, 169

- Orville J., 407  
 Otto P., 451, 452  
 Theodore M., 145  
 Moir, James, 232, 233  
 John, 232  
 John M., 232  
 Monaghan, Francis M., 511,  
 512  
 Richard, 511  
 Moore, Edward P., 408  
 Thomas, 125  
 Morgan, David T., 541  
 John, 541  
 T. Archer, 540, 541  
 Thomas S., 541  
 Morss, Leonidas W., 330  
 Mosher, Luthan B., 140  
 Mulholland, Bernard, 458  
 Henry W., 458  
 Murphy, Francis L., 358,  
 359  
 James R., 394  
 M. J., 494  
 Sarah A., 395  
 Murray, Michael J., 350,  
 351  
 Michael J. Jr., 352  
 Napier, John, 474  
 William E., 474  
 Nash, Joseph, 467  
 William L., 466, 467  
 Nettleton, Augustus C., 514,  
 515  
 Franklyn E., 515  
 Neuffer, Carl W. F., 409  
 Charles D., 409  
 Nicholson, Addison A., 456  
 Fitch, 456  
 Homer, 456  
 Noecker, Charles B., 320,  
 327  
 John, 326  
 Lewis, 327  
 Nolan, James, 591  
 Joseph H., 591, 592  
 Norton, Mary E., 563  
 Michael, 562  
 Oakford, James W., 215,  
 217  
 Joseph, 215  
 Richard A., 215  
 O'Brien, John E., 478  
 Richard, 477  
 O'Donnell, Patrick, 260  
 William P., 260  
 O'Malley, James J., 337  
 Michael, 337  
 Thomas B., 84  
 William G., 83, 84  
 O'Neill, Hugh, 354  
 James J., 354  
 Osterhout, Edward W., 358  
 Guy W., 506  
 Mary E., 358  
 Milo D., 506  
 Owens, John J., 553  
 Paine, Hendrick E., 312,  
 313  
 Stephen, 312  
 Palmer, Charles, 400  
 Jesse, 400  
 Palumbo, Salvatori, 601  
 Parker, Charles B., 617, 618  
 Edwin R., 650  
 Fernando A., 618  
 Rondino, 616  
 Sheldon, 617  
 Sheldon W., 650  
 Stephen, 617  
 Sterling D., 616, 617  
 Parrish, George H., 306  
 Justin E., 305, 306  
 Pauli, Francis S., 378, 379  
 George, 378  
 Herman R., 378  
 Lewis J., 379  
 Philip K., 379  
 Margaret F., 380  
 Reinhold, 378  
 Peck, Eliphalet, 201  
 Fenwick L., 235  
 George, 202  
 George L., 201, 203  
 Jesse, 201  
 John, 201  
 Jonathan W., 235  
 Joseph, 235  
 Luther, 202  
 Luther W., 203  
 Simon, 235  
 Penman, Charles B., 631  
 Harriet C., 631  
 James, 631  
 Phillips, Philip R., 684  
 Pinnell, John W., 303, 304  
 Jones T., 303  
 Platt, Frank E., 180  
 Frederick, 177  
 Frederick J., 181, 182  
 Joseph, 181  
 Joseph C., 177  
 Pond, Alvin P., 105  
 Charles H., 105  
 Porter, Abel J., 139  
 John T., 139  
 Post, Arthur, 66  
 Carrie I., 564  
 Goosen, 65  
 Isaac, 67, 68  
 Isaac L., 67  
 Jacob, 564  
 John, 66, 67  
 Panwell V., 66  
 Peter, 65  
 Peter A., 65  
 Richard, 66  
 Robert F., 563, 564  
 Powell, Charles J., 167, 168  
 Howard, 466  
 James M., 465, 466  
 James S., 168  
 Lewis B., 168  
 Public Library, 253  
 Price, Thomas J., 340  
 Rader, John B., 563  
 Philip, 563  
 Redding, Leonard G., 355  
 Reedy, David J., 260  
 John, 260  
 Reilly, David M., 600  
 Peter F., 640  
 Thomas, 600, 640  
 Renner, Frank W., 530  
 Gustav F., 530  
 Reynolds, George, 62  
 George F., 61, 62  
 Rice, James N., 282  
 Sarah E., 283  
 William, 282  
 Richards, John T., 52  
 Thomas, 52  
 Richmond, John, 640  
 Robert R., 640  
 William H., 630, 641  
 William W., 640  
 Riegel, Isaac M., 531  
 John L., 531  
 Rinsland, John, 314  
 Philip, 314  
 Ripple, Ezra H. Jr., 61  
 Rittenhouse, Benjamin F.,  
 322  
 James H., 322, 323  
 Matthias, 322  
 Robertson, David, 679  
 John, 679  
 John M., 679  
 William G., 635  
 Robinson, Edmund J., 657  
 Otto J., 659  
 Mina, 657  
 Philip, 657  
 Robert, 658  
 Roblee, Milton, 421  
 Roche, John E., 342  
 Rogers, Adelbert E., 353  
 George W., 353  
 Roos, Elias G., 209, 210  
 Rabbi Kaufman, 209  
 Samuel, 209  
 Rosar, Charles G., 507, 508  
 Peter, 507  
 Rose, Charles C., 131  
 William C., 131  
 Ross, Charles S., 626, 627  
 J. Elliott, 627  
 Roth, Max, 633  
 William, 633  
 Ruddy, John J., Rev., 355  
 Rushmore, J. Edward, 673,  
 674  
 John F., 673  
 Rutherford, Herman C.,  
 296  
 Robert W., 296  
 Ruthven, Robert C., 450,  
 451  
 Robert E., 450

- Sampson, Chester C., 546  
 Samter, Jacob, 81  
   Samuel, 81, 82  
 Sanderson, Abraham, 131  
   Benjamin L., 256  
   Charles D., 254, 256  
   Clarence M., 256  
   Edward, 132  
   George, 132  
   George, Col., 133  
   Jacob, 131  
   Jonathan, 132, 254, 255  
   Samuel, 132, 255, 256  
 Sando, Joseph W., 287  
   Michael F., 287  
 Savage, Charles P., 55, 56  
   Joseph, 55  
   Robert P., 55  
 Scheuer, John, 164  
 Schiller, Aaron, 588  
   Abraham L., 588  
   Leib, 588  
 Schillinger, Christian, 464,  
   465  
 Schimpff, Eugene, 527  
   Jacob, 527  
   Philip, 527  
 Schlager, Jacob, 644  
   Jacob R., 644  
 Schoenfeld, Reinhard, 428  
   William C., 427, 428  
 Schoonmaker, Alexander,  
   663  
   Col. U. G., 663, 664  
   Jacob, 663  
 Schoonover, William, 629  
   William J., 629, 630  
 Schriever, Jacob, 337  
   James B., 337  
 Schubert, Henry J., 376, 377  
   William, 376  
 Schunk, Jacob, 672  
   William A., 672  
 Schwenker, John G., 567  
   John U., 567  
 Scott, Frederick E., 638,  
   639  
   Samuel, 638  
 Scranton, Ichabod, 29  
   John, 28  
   Jonathan, 29  
   Joseph H., 29  
   Theophilus, 29  
   William W., 30  
   Worthington, 32  
 Seamans, Charles S., 340,  
   341  
   John, 340  
   John M., 340  
 Sedlak, Frank J., 393  
 Severson, Irwin W., 419  
   Oscar L., 419  
 Shafer, Casper, 42  
   Hampton C., 42  
 Shindel, Conrad F., 646  
 Shoemaker, Layton L., 154  
   Theodore, 154  
 Siebecker, Louis J., 578  
   William, 578  
 Siegel, Harry M., 624  
 Simons, Edward F., 573  
   Edward G., 573  
 Sinn, Andrew C., 109  
   Joseph A., 109, 110  
 Simpson, Christopher, 241  
   Clarence D., 241, 242  
   John, 141  
   William S., 241  
 Slocum, Anthony, 261  
   Ebenezer, 262  
   George W., 261, 264  
   Giles, 261  
   Jonathan, 262  
   Joseph, 261, 263  
   Joseph W., 264  
   Samuel, 261  
 Smith, Frederick D., 608  
   Garrett, 152, 153  
   George B., 616  
   Gustave, 434  
   Gustave F., 433, 434  
   Harry F., 608  
   Jacob, 153  
   John B., 616  
   John F., 433  
   Peter, 153  
   Ruel, 19  
   William T., 19  
 Snyder, David N., 357  
   Elizabeth D., 628  
   Jacob B., 628  
   Marion D., 357  
 Spencer, Harry M., 392  
   Sylvester, 392  
 Sporer, John, 506  
   Michael, 506  
 Sprague, Edward H., 315  
   Thomas, 315, 316  
 Spruks, David, 345  
   John, 345  
 Stackhouse, Fletcher C.,  
   464  
   Jesse B., 464  
 Steell, Joseph H., 214  
 Stender, Ferdinand J., 450  
   Herman F., 449, 450  
 Stephens, A. Wesley, 135  
   Morton W., 135  
 Stevens, Charles H., 410  
   Fred D., 410  
 Stevenson, George E., 397  
   Stephen, 397  
 Stillwell, Frederick W., 245  
   Richard, 245  
 Stipp, Ludwig, 137, 446  
   Ludwig T., 447  
   Mathias, 137  
   Peter, 446  
 Stocker, Albert, 265  
   Frank R., 265, 266  
   James D., 265  
 Stone, Aslan, 638  
   Francis O., 171, 172  
   John A., 637, 638  
   Oscar, 171  
 Stuckart, Anthony F., 63  
   George F., 63  
 Sturges, Edward B., 669  
   Thomas B., 669  
 Sutton, Cyrus O., 494, 495  
   Peter, 495  
 Sweet, George, 317  
   William, 317  
 Swift, Michael J., 391  
 Sylvester, Philip L., 149  
 Taylor, Charles C., 622  
   F. A., Mrs. 264  
   Herbert L., 385  
   Jasper C., 621, 622  
   John A., 621  
   Reuben, 621  
   Reuben W., 386  
 Thomson, Alexander, 218  
   Charles E., 218  
 Throop, Benjamin H., 9, 10,  
   11, 13  
   Dan, 11  
   George S., 13  
   William, 10  
 Tobey, Albert B., 551  
   Charles E., 551, 552  
   Edward, 551  
 Toohey, John J., 540  
   Thomas, 540  
 Torrey, James H., 267  
   William, 267  
 Touhill, Charles V., 675  
   Edward, 675  
   John A., 675  
 Vallario, Michael, 599  
   Nicholas, 599  
 Valverde, Rev. Francis, 649  
 Van De Water, Peter, 373  
   William G., 373  
 VanDensen, Coonrod, 240  
   Henry, 240  
   Henry N., 240  
   Henry R., 240  
   Isaac, 239  
   John, 240  
 Vasey, George F., 593  
   John, 593  
   William, 593  
 Villone, Joseph, 381, 382  
   Vitale, 382  
 Vincent, George, 247  
   I. Raymond, 247  
   Isaac, 247  
 Von Bergen, Andrew, 204  
   John, 204, 205  
 Von Storch, Charles H.,  
   212  
   Christian T., 211  
   Godfrey, 212  
   Heinrich L., 211, 645  
   Jessica P., 646  
   Johann G., 211

- Theodore, 645  
Theodore C., 645, 646
- Vosburg, Alton A., 99  
Merritt B., 99  
Stephen, 99
- Voyle, David M., 463  
Thomas M., 463
- Waddell, Addison, 620  
James, 620  
Joseph A., 620, 621
- Wagner, Frederick, 100  
Frederick A., 101  
Joseph, 100
- Wahl, George, 431, 432
- Wainwright, Jonathan M., 98  
William A. M., 98
- Wakeman, Benjamin S., 625, 626  
Seth, 625
- Waldner, Frederick G., 592
- Walker, George A., 416  
J. Moulton, 416  
Sabinus, 416
- Wallace, Charles R., 402  
Frank C., 402  
H. Clifford, 130
- Walter, Michael, 568  
Paul S., 568
- Wardle, James F., 77  
Joseph, 77
- Warman, Andrew B., 129  
Theodore P., 129
- Warren, Harris F., 207  
Henry G., 505  
Isaac, 207  
Major Everett, 206, 207  
Philip H., 505
- Watkins, Daniel R., 97  
Edward, 97  
George W., 422, 423
- John T., 610, 611  
William W., 439, 610
- Watres, Lewis S., 188  
Louis A., 188, 189
- Watson, Benjamin E., 115  
Charles, 115
- Webber, Richard, 384  
Wesley J., 384
- Wedeman, Daniel, 138  
Louis P., 138  
Martin P., 138  
Peter, 138
- Weeks, Arthur L., 273, 275  
Ralph, 273  
Ralph E., 274
- Weinschenk, Anton, 366  
Arthur A., 366
- Weissenfluh, J. Edwin, 441, 442  
John, 442
- Welles, Charles H., 106  
Charles H. Jr., 106
- Wells, Corydon H., 294  
Thomas F., 294, 295
- Wenzel, Charles E., 411, 412  
Conrad, 411
- Weston, Charles S., 5, 6  
Edward W., 5
- Westpfahl, Albert F., 404  
John, 404
- White, James B., 505  
J. Norman, 509  
Joseph, 509  
Robert E., 505  
Robert V., 505, 506  
Sidney, 509  
Stephen, 505
- Wilcox, Edward, 284  
Isaiah, 284  
Nathan P., 285
- Stephen, 284  
William A., 285
- Williams, Carlos D., 250  
Carey P., 250, 251  
Edwin S., 362, 363  
Erastus P., 250  
Jeremiah, 362  
John F., 75  
John R., 75  
Reese, 68  
Silas, 250  
Tudor R., 69  
William R., 68
- Wills, Henry, 581  
Robert C., 581
- Winans, Elihu, 448  
George G., 449  
George H., 448, 449
- Winters, Peter C., 509, 510  
Robert, 510
- Winton, Andrew J., 50  
Walter W., 51  
William W., 50
- Woelkers, Charles, 654  
Herman J., 654
- Wolf, Edward L., 15  
George, 14  
Theodore G., 13, 16
- Wollerton, Frederick W., 107  
William, 107
- Woodruff, Andrew, 271  
Clarence S., 271  
Lewis H., 271
- York, Samuel F., 93, 94  
William F., 94
- Zeidler, John, 462  
Maggie, 463
- Zimmer, George A., 348  
John, 347, 348
- Zivatas, Frank, 575















