

EX LIBRIS

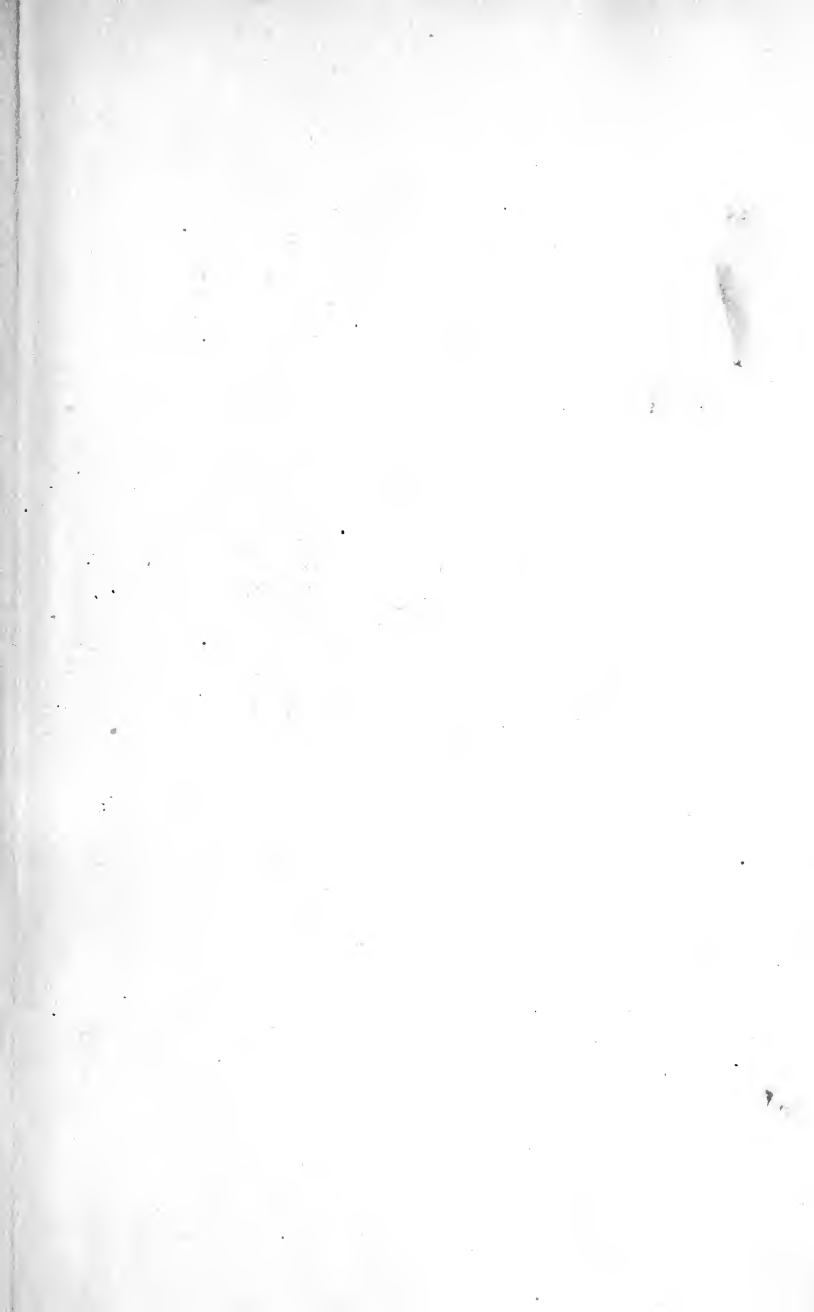

THE UNIVERSITY OF CHICAGO  
LIBRARY

# HOME AND FARM FOOD PRESERVATION

BY

WILLIAM V. CRUESS

ASSISTANT PROFESSOR OF FOOD TECHNOLOGY (ZYMOMOLOGY)  
UNIVERSITY OF CALIFORNIA EXPERIMENT STATION



New York  
THE MACMILLAN COMPANY

1918

*All rights reserved*

TX601  
C7

COPYRIGHT, 1918  
By THE MACMILLAN COMPANY  
Set up and electrotyped. Published July, 1918.

THE  
MACMILLAN  
COMPANY

## PREFACE

Since early historical time food preservation has been second only in importance to food production. Grapes and other fruits were dried by the ancients to preserve them; fruit juices were fermented to make wines and vinegars; cereals and vegetables were stored to protect them against moisture and decay; olives were preserved by salting; and meats were salted, dried, and smoked. The use of sugar and vinegar in preserving fruits and vegetables came later. The preservation of foods by sterilization in sealed containers is a development of the nineteenth century and dates from its discovery by Nicholas Appert in France about 1800. Cold storage, as a means of preserving all perishable products, has, during the past century, developed into a very great industry.

Three billion cans of food, valued retail at \$600,000,000, were sold in the United States in 1916. The meat packing and cold storage industries compare favorably with the canning industries in size. The wholesale value of the raisin crop in California is over \$10,000,000 annually. The other dried fruit industries are smaller but their aggregate value amounts to many millions of dollars yearly in the United States. From this, the importance of commercial food preservation may be seen.

Commercial food preservation cares for the bulk of the food products but beside the food so preserved, there are many millions of jars and cans of fruits and vegetables, glasses of jellies, jams, and marmalades and many thousands of hams and bacons "put up," by the housewife and farmer. Much food that would otherwise be wasted is saved and in addition a varied diet throughout the year at low cost is made available in many homes.

Usually this work is done over a hot kitchen stove during the rush of the fruit or vegetable season and, added to other household duties, becomes a heavy burden. The methods are empirical and by "rule of thumb"; consequently they are not well understood and not especially interesting.

This book aims to tell the "why" of the various methods of food preservation, to present labor saving methods and to give simple and explicit directions that may be easily followed. When the principles of the various methods are understood the directions given can be modified to suit changed conditions and the work will prove very much more interesting because the reasons for the various steps will be known.

The book is divided into three sections, namely: "The Theory of Food Preservation," "Methods of Food Preservation," and "Food Preservation Recipes." By reading the first two sections, the fundamental principles and an understanding of the general application of these principles will be obtained. This will be of great assistance in intelligently carrying out the specific directions given in the recipes in the third section.

The material presented is designed primarily for the housewife and farmer, to assist them in preserving surplus farm products for their own use. However, in many places, the food products, if carefully and attractively prepared, can be sold at a good profit, in this way affording an extra source of income. Often commercial factories develop from such small beginnings.

It is hoped also that the material presented will be of value and interest to domestic science teachers and canning demonstrators.

The aim has been to so present the principles and practices of preservation of food in the home that the work will appear more fascinating and less burdensome and that the results obtained will be more successful.



The author wishes to express his appreciation of the many valuable and helpful suggestions given by Professor F. T. Bioletti during the preparation of the manuscript for this book.

W. V. CRUESS.

Digitized by the Internet Archive  
in 2007 with funding from  
Microsoft Corporation

# CONTENTS

## *PART I. THEORY OF FOOD PRESERVATION*

### CHAPTER I

#### WHY FOOD SPOILS

	PAGE
1. Molds.....	3
2. Yeasts.....	5
3. Bacteria.....	6
4. Spoiling of Foods by Chemical and Physical Changes....	7

### CHAPTER II

#### WAYS OF PREVENTING SPOILING

A. TEMPORARY PREVENTION OF SPOILING.....	9
5. Asepsis.....	9
6. Cold Storage.....	9
7. Exclusion of Moisture.....	10
8. Use of Mild Antiseptics.....	10
9. Pasteurization as a Means of Temporary Preservation....	11
10. Exclusion of Air.....	12
B. PERMANENT PREVENTION OF SPOILING.....	12
11. Preservation by Sterilization by Heat.....	13
12. Preservation by Use of Antiseptics.....	14
13. Preservation by Drying.....	16
14. Preservation by Smoking.....	16
15. Preservation by Fermentation.....	17
16. Exclusion of Air.....	17

## PART II. METHODS OF FOOD PRESERVATION

## CHAPTER III

## CANNING FRUITS

	PAGE
1. Picking.....	21
2. Grading and Sorting.....	23
3. Peeling, Pitting, Coring, and Cutting.....	23
4. Jars.....	25
5. Wax Top Cans.....	26
6. Solder Top Cans.....	28
7. Cooking the Fruit before Filling the Containers; or Hot Pack Method.....	29
8. Filling Jars and Cans without Previous Cooking of the Fruit; or Cold Pack Method.....	30
9. Sanitary Cans.....	32
10. Sizes of Cans.....	34
11. New Weights that Cans for Market must Contain.....	34
12. Sirups and Hydrometers.....	37
13. Cane <i>vs.</i> Beet Sugar.....	39
14. Exhausting.....	40
15. Sterilization of Fruits.....	41

## CHAPTER IV

## CANNING VEGETABLES

16. Canning Vegetables—Peeling and Preparing.....	45
17. Blanching or Parboiling.....	46
18. Chilling.....	48
19. Brines and Acidified Brines.....	48
20. Addition of the Brine.....	50
21. Sterilization.....	50
(a) Pressure Sterilization.....	50
(b) Intermittent or Three-Day Sterilization of Vege- tables at 212° F.....	52
(c) Sterilization of Vegetables at 212° F. by One- Period Method.....	53
(d) Sterilization by the Lemon Juice Method.....	53

# CONTENTS

xi

## CHAPTER V

### CANNING OF MEATS

	PAGE
22. Preparation of Meats for Canning.....	55
23. Sterilization of Meats.....	56

## CHAPTER VI

### STORAGE AND SPOILING OF CANNED FOODS

24. Storage of Canned Foods.....	57
25. Spoiling of Canned Foods—Botulinus Poisoning.....	57

## CHAPTER VII

### FRUIT JUICES

26. Fruits for Juice.....	60
27. Crushing.....	61
28. Heating before Pressing.....	62
29. Pressing.....	63
30. Clearing the Juice.....	64
31. Bottling and Canning.....	66
32. Pasteurization of Fruit Juices.....	68

## CHAPTER VIII

### FRUIT AND OTHER SIRUPS

33. Sources of Sirups.....	72
34. Clearing the Juice.....	72
35. Deacidification.....	72
36. Concentration.....	73
37. Storing the Sirup.....	75

## CHAPTER IX

## JELLIES AND MARMALADES

	PAGE
38. Fruits for Jelly . . . . .	76
39. Preparing and Cooking the Fruit . . . . .	77
40. Expressing and Clearing the Juice . . . . .	79
41. Testing for Pectin . . . . .	79
42. Testing for Acid . . . . .	80
43. Addition of Sugar . . . . .	80
44. Sheeting Test for Jelling Point . . . . .	81
45. Thermometer Test . . . . .	81
46. Hydrometer Test for Jelling Point . . . . .	82
47. Meaning of Thermometer and Hydrometer Tests . . . . .	83
48. Pouring and Cooling the Jelly . . . . .	83
49. Coating with Paraffin . . . . .	83
50. Sterilization of Jellies . . . . .	84
51. Jellies without Cooking . . . . .	84
52. Jelly Stocks . . . . .	85
53. Crystallization of Jellies . . . . .	85
54. Marmalades . . . . .	85

## CHAPTER X

## FRUIT JAMS, BUTTERS, AND PASTES

55. Jams . . . . .	87
56. Fruit Butters . . . . .	87
57. Fruit Pastes . . . . .	88

## CHAPTER XI

## FRUIT PRESERVES AND CANDIED FRUITS

58. Preserves . . . . .	89
59. Candied Fruits . . . . .	90

# CONTENTS

xiii

## CHAPTER XII

### FRUIT DRYING

	PAGE
60. Fruit Drying—Importance of the Industry . . . . .	93
61. Gathering the Fruit . . . . .	94
62. Transfer to the Dry Yard . . . . .	94
63. Cutting and Peeling . . . . .	95
64. Dipping Fruits before Drying . . . . .	95
65. Sulphuring Fruits before Drying . . . . .	96
66. Trays for Sun Drying . . . . .	101
67. Sun Drying . . . . .	101
68. Artificial Evaporation . . . . .	104
69. Sweating . . . . .	109
70. Processing and Packing . . . . .	109

## CHAPTER XIII

### VEGETABLE DRYING

71. Vegetables for Drying . . . . .	112
72. Preparation . . . . .	112
73. Blanching . . . . .	113
74. Sulphuring . . . . .	113
75. Sun Drying . . . . .	113
76. Artificial Drying . . . . .	114
77. Processing Sun Dried Vegetables . . . . .	115
78. Packing and Storing Dried Vegetables . . . . .	115

## CHAPTER XIV

### VINEGAR MANUFACTURE

79. General Principles . . . . .	116
80. Raw Materials . . . . .	116
81. Crushing Fruits for Vinegar . . . . .	117

	PAGE
82. Diluting Honey.....	117
83. Preparation of Fruit Cores and Peels and Dried Fruits for Vinegar Making.....	118
84. Addition of Yeast and Control of Alcoholic Fermentation.....	118
85. Pressing Fermented Fruits.....	119
86. Removal of Sediment.....	120
87. Adding Vinegar Starter.....	120
88. Vinegar Fermentation.....	120
89. Vinegar Generators.....	122
90. Aging of Vinegar.....	124
91. Clearing the Vinegar.....	125
92. Vinegar Diseases and Pests.....	125
(a) Wine Flowers.....	125
(b) Lactic Acid Bacteria.....	125
(c) Vinegar Eels.....	126

## CHAPTER XV

## FRUIT WINES

93. Red Wine.....	127
(a) Crushing.....	127
(b) Yeast.....	127
(c) First Fermentation.....	127
(d) Pressing.....	128
(e) Final Fermentation.....	128
(f) Settling and Filling Up.....	128
(g) Racking.....	128
(h) Aging.....	128
(i) Clearing the Wine.....	129
(j) Bottling.....	129
94. White Wine.....	129
(a) Crushing, Pressing, and Settling.....	129
(b) Fermentation.....	129
(c) Racking, Filling Up, Aging, Clearing.....	129
95. Other Fermented Fruit Juices.....	129



## CHAPTER XVI

PRESERVATION OF VEGETABLES AND FRUITS BY  
SALTING AND PICKLING

	PAGE
96. Preservation of Vegetables by Salt . . . . .	131
(a) Dry Salting . . . . .	131
(b) Salt and Fermentation . . . . .	132
(c) Strong Brine . . . . .	133
97. Dill Pickles . . . . .	134
98. Pickling Vegetables in Vinegar . . . . .	135
(a) Storage in Brine . . . . .	135
(b) Removal of Salt . . . . .	136
(c) Addition of Vinegar . . . . .	136
99. Pickling Fruits in Vinegar . . . . .	136
100. Olives . . . . .	136
(a) Pickled Ripe Olives . . . . .	136
(b) Green Olives . . . . .	139
(c) "Greek" Olives . . . . .	139
101. Tomato Ketchup . . . . .	140
(a) Pulping . . . . .	140
(b) Addition of Flavoring Materials . . . . .	140
(c) Boiling . . . . .	141
(d) Sterilizing . . . . .	141
102. Miscellaneous Tomato Products . . . . .	141
(a) Tomato Paste . . . . .	141
(b) Purée . . . . .	142
(c) Chili Sauce, Piccalilli, and Relishes . . . . .	142

## CHAPTER XVII

## PRESERVATION OF MEAT

103. Salting Meats . . . . .	143
(a) Dry Salting . . . . .	143
(b) Preserving Meats in Brine . . . . .	143
104. Drying Meats . . . . .	145
105. Preservation of Meats by Smoking . . . . .	145
(a) Salting . . . . .	145

	PAGE
(b) The Smoke House . . . . .	146
(c) Smoke Producing Substances . . . . .	147
(d) Length of Smoking . . . . .	148
(e) Storing Smoked Meats . . . . .	148
106. Miscellaneous Meat Products . . . . .	148
107. Preservation of Eggs with Water Glass . . . . .	149

## CHAPTER XVIII

## MILK PRODUCTS

108. Sterilization and Pasteurization of Milk . . . . .	150
(a) Sterilization . . . . .	150
(b) Pasteurization of Milk in the Household . . . . .	150
109. Storage of Butter . . . . .	151
110. Cheese . . . . .	152
(a) "Cottage" Cheese . . . . .	152
(b) Cheddar Cheese . . . . .	153
(c) Other Types of Cheese . . . . .	153

*PART III. FOOD PRESERVATION RECIPES*

## CHAPTER XIX

## FRUIT CANNING RECIPES

1. Canning Peaches . . . . .	157
2. Alternative Method for Canning Peaches . . . . .	161
3. Canning Apricots . . . . .	162
4. Lye Peeling Peaches and Apricots . . . . .	163
5. Canning Pears . . . . .	163
6. Canning Cherries . . . . .	164
7. Canning Apples . . . . .	165
8. Canning Plums . . . . .	165
9. Canning Rhubarb . . . . .	166
10. Canning Rhubarb without Sterilization . . . . .	166
11. Canning Figs . . . . .	166

## CONTENTS

xvii

	PAGE
12. Canning Strawberries.....	167
13. Canning Blackberries.....	168
14. Canning Raspberries and Loganberries.....	168
15. Canning Oranges.....	168
16. Canning Grape Fruit.....	169
17. Canning Grapes.....	169
18. Canning Pineapple.....	170
19. Canning Currants, Cranberries, and Gooseberries.....	170

## CHAPTER XX

### CANNING VEGETABLES

20. Canning Artichokes.....	171
21. Canning Asparagus.....	172
22. Canning Green String Beans and Wax Beans.....	173
23. Canning Beets.....	173
24. Canning Carrots, Turnips, Parsnips, and Onions.....	174
25. Canning Corn.....	175
26. Canning Green Peas.....	175
27. Canning Pimentos and Sweet Peppers.....	176
28. Canning Pumpkin and Squash.....	176
29. Canning Spinach and Other Greens.....	177
30. Canning Tomatoes.....	177
31. Canning Sweet Potatoes.....	178
32. Canning Dried Beans.....	179
33. Canning Hominy.....	179
34. Canning Egg Plant.....	180
35. Canning Okra.....	180

## CHAPTER XXI

### CANNING MEATS

36. Canning Meats without Preliminary Cooking.....	182
37. Canning Cooked Meats.....	182
38. Canning Corned Beef.....	183
39. Canning Fresh Fish.....	183
40. Canning Kippered Fish.....	184

## CHAPTER XXII

## FRUIT JUICES

	PAGE
41. Apple Juice . . . . .	185
42. Red Grape Juice . . . . .	186
43. Loganberry, Blackberry, and Raspberry Juices . . . . .	188
44. Lemon Juice . . . . .	188
45. Orange Juice . . . . .	188
46. Orange-Lemon Juice . . . . .	189
47. Grape Fruit Juice . . . . .	189
48. Pomegranate Juice . . . . .	190
49. Pineapple Juice . . . . .	190
50. Clarification of Fruit Juices . . . . .	190

## CHAPTER XXIII

## RECIPES FOR SIRUPS

51. Fruit Sirups for Cooking Purposes . . . . .	192
52. Fruit Sirups for Table Use . . . . .	193
53. Fruit Sirups by Sun Evaporation . . . . .	193
54. Fruit Sirups Made by the Addition of Sugar . . . . .	194
55a. Sorghum Sirup . . . . .	194
55b. Manufacture of Sorghum on Small Commercial Scale . . . . .	194
56. Sugar Beet Sirup . . . . .	197

## CHAPTER XXIV

## RECIPES FOR JELLIES AND MARMALADES

57. Jellies . . . . .	198
58. Jelly Stocks . . . . .	200
59. Jellies without Cooking . . . . .	200
60. Orange Marmalade . . . . .	201
61. Grape Fruit and Other Marmalades . . . . .	201

# CONTENTS

xix

## CHAPTER XXV

### RECIPES FOR FRUIT JAMS, BUTTERS, AND PASTES

	PAGE
62. Fruit Jams . . . . .	202
63. Fruit Butters with the Addition of Sugar . . . . .	202
64. Fruit Butters without the Addition of Sugar . . . . .	203
65. Fruit Pastes . . . . .	203

## CHAPTER XXVI

### RECIPES FOR PRESERVES

66. Fig Preserves . . . . .	205
67. Peach, Pear, and Quince Preserves . . . . .	205
68. Strawberry Preserves . . . . .	205
69. Watermelon Preserves . . . . .	206
70. Tomato Preserves . . . . .	206
71. Preserved Kumquats . . . . .	206
72. Preserves made without Cooking . . . . .	207

## CHAPTER XXVII

### CANDIED FRUITS

73. Candied Fruits with Use of Sugar Tester . . . . .	208
74. Candying Fruits without the Use of a Sugar Tester . . . . .	209

## CHAPTER XXVIII

### RECIPES FOR DRYING FRUITS

75. Sun Drying Apricots, Pears, Peaches, and Apples . . . . .	211
76. Sun Drying Prunes . . . . .	213
77. Drying Thompson Seedless and Sultana Grapes . . . . .	214
78. Drying Muscat and "Currant" Grapes . . . . .	215
79. Packing Raisins . . . . .	215
80. Sun Drying Cherries . . . . .	215

	PAGE
81. Sun Drying Figs.....	215
82. Drying Fruits in Evaporators.....	216
(a) Driers.....	216
(b) Preparation of Fruit.....	216
(c) Apples.....	216
(d) Apricots and Peaches.....	216
(e) Berries.....	216
(f) Cherries.....	216
(g) Pears.....	216
(h) Prunes.....	216
(i) Grapes.....	216
(j) Figs.....	217
(k) Processing and Storing.....	217

## CHAPTER XXIX

### RECIPES FOR DRYING VEGETABLES

83. Sun Drying String Beans and Peas.....	218
84. Sun Drying Corn.....	219
85. Sun Drying Irish Potatoes.....	219
86. Sun Drying Sweet Potatoes.....	219
87. Sun Drying Carrots, Turnips, Onions, Cabbage, and Cauliflower.....	219
88. Sun Drying Beets, Pumpkin, and Squash.....	219
89. Sun Drying Tomatoes.....	220
90. Sun Drying Peppers.....	220
91. Drying Vegetables in an Artificial Evaporator.....	220

## CHAPTER XXX

### RECIPES FOR VINEGAR MAKING

92. Home Manufacture of Vinegar from Whole Fruits.....	222
93. Vinegar from Cores, Peels, and Fruit Scraps.....	223
94. Vinegar from Honey and Sirups.....	223
95. Clarifying Vinegar.....	223

## CHAPTER XXXI

## RECIPES FOR FRUIT WINES

	PAGE
96. Red Wine.....	225
97. White Wine.....	226
98. Hard Cider from Apples, Oranges, and other Fruits.....	226

## CHAPTER XXXII

RECIPES FOR PRESERVATION OF VEGETABLES BY  
SALT OR FERMENTATION

99. Preservation of Vegetables by Dry Salt.....	227
100. Preservation of Vegetables in Strong Brine.....	228
101. Preservation of Cabbage by Fermentation (Sauerkraut)..	228
102. Preservation of String Beans, Beets, and Greens by Fermentation.....	229
103. Preservation of Vegetables by Fermentation in Brine....	229
104. Dill Pickles.....	230

## CHAPTER XXXIII

## RECIPES FOR PICKLES AND RELISHES

105. Cucumber Pickles in Vinegar.....	231
106. Onion, Green Tomato, and Cauliflower Pickles in Vinegar	231
107. Sweet Vegetable Pickles.....	232
108. Sweet Fruit Pickles.....	232
109. Sweet Pickled Watermelon Rind.....	233
110. Spiced Green Tomatoes.....	233
111. Chow Chow.....	233
112. Mustard Pickles.....	234
113. Piccalilli.....	235
114. Chili Sauce.....	235
115. Dixie Relish.....	236
116. Chutney.....	237
117. Stuffed Pickled Sweet Peppers.....	237

	PAGE
118. Green Tomato Pickle . . . . .	238
119. Tomato Ketchup . . . . .	238
120. Tomato Paste . . . . .	239
121. Ripe Olive Pickles . . . . .	240
122. Green Olive Pickles . . . . .	241
123. Ripe Olive Paste . . . . .	242
124. Ripe Olives Cured by the Salt Process . . . . .	242
125. Dessicated Olives . . . . .	242

## CHAPTER XXXIV

## RECIPES FOR THE HOME PRESERVATION OF MEATS AND EGGS

126. Plain Salt Pork . . . . .	243
127. Corned Beef . . . . .	244
128. Sugar Curing Hams and Bacon for Smoking . . . . .	245
129. Dry Curing of Pork for Smoking . . . . .	245
130. Salting Beef for Drying . . . . .	246
131. Preservation of Fish by Salting . . . . .	246
132. Home Made Smoke House . . . . .	247
133. Fuel for Smoking . . . . .	248
134. Ham and Bacon . . . . .	248
135. Dried Smoked Beef . . . . .	248
136. Smoking Large Fish . . . . .	248
137. Smoking Small Fish . . . . .	249
138. Drying Fish . . . . .	249
139. Dried Beef and Venison ("Jerkey") . . . . .	250
140. Preservation of Eggs in Water Glass . . . . .	250
141. Preservation of Eggs in Lime and Salt . . . . .	250

## CHAPTER XXXV

## RECIPES FOR DAIRY PRODUCTS

142. Gouda Cheese . . . . .	251
143. Cottage Cheese . . . . .	254
144. The Preservation of Butter by Salt . . . . .	255
Appendix . . . . .	257



## LIST OF ILLUSTRATIONS

FIGURE	PAGE
1. Preparing Fruit for Canning.....	22
2. Types of Knives for Preparation of Fruit.....	24
3. Cherry Pitter for Home Use.....	25
4. Apple Peeling Machine for Home Use.....	26
5. Common Types of Jars.....	27
6. Common Types of Cans for Home Canning.....	27
7. Useful Utensils in Canning.....	28
8. Blanching and Chilling Vegetables before Canning.....	30
9. Filling Jars with Heated Fruit.....	31
10. Filling Jars with Hot Brine or Sirup before Lowering Them into Sterilizer.....	32
11. Gasoline Fire Pot for Heating Soldering Irons.....	33
12. View in Modern Cannery Sealing Cans.....	35
13. Hand Power Capping Machine for Sanitary Cans.....	38
14. A Convenient Form of Washboiler Sterilizer.....	41
15. Washboiler Sterilizer with Cover Made Tight by Use of a Cloth.....	43
16. Closing Jars after Sterilizing.....	46
17. Positions of Clamp on Glass Top Jar before and after Sterilizing.....	47
18. Home Size Steam Pressure Sterilizer.....	48
19. Normal and Spoiled Cans of Food.....	58
20. Small Crusher for Home Use.....	61
21. Pressing Crushed Fruit.....	62
22. Small Crusher and Press for Farm Use.....	63
23. Straining Juice after Pressing.....	64
24. Capping Bottles with Small Hand Power Crown Capper...	67
25. Sterilizing Bottles of Juice.....	68
26. Wooden Vat with Steam Coil for Use in Sterilizing Bottles of Juice or Cans of Food.....	69
27. Plan for Arrangement of Steam Coil of Figure 26.....	69
28. Dipping Ends of Bottles in Melted Paraffin to Seal Corks after Pasteurizing.....	70

FIGURE	PAGE
29. Apparatus for Sun Evaporation of Fruit Juices . . . . .	73
30. The Pectin Test . . . . .	76
31. The Thermometer Test for Jellies . . . . .	78
32. The Baumé Hydrometer for Jelly Test . . . . .	82
33. Marmalade Slicer . . . . .	86
34. Placing Candied Fruits on Wire Screen to Drain . . . . .	91
35. Knocking Ripe Prunes from Trees for Drying . . . . .	94
36. Dipping Prunes and White Grapes in Boiling $\frac{1}{2}\%$ Lye Solution before Drying . . . . .	96
37. Upper View. Fruit Dipper for Prunes . . . . .	97
Lower View. Stacking Fruit that is Nearly Dry . . . . .	97
38. Views of Drying Yards in California . . . . .	98
39. Small Fruit Sulphuring Box for Home Use . . . . .	100
40. Sulphuring Fruit on a Large Scale in California . . . . .	101
41. Muscat Grapes Drying on Trays in the Vineyard . . . . .	102
42. Sorting Dried Prunes . . . . .	103
43. Pomona Vegetable Peeler . . . . .	104
44. A Home Made Dryer for Use above the Kitchen Stove . . . . .	105
45. Small Home Made Cabinet Dryer . . . . .	106
46. Galvanized Iron Fruit and Vegetable Dryer for Farm Use . . . . .	107
47. Packing of Dried Vegetables in Insect-Proof Containers . . . . .	114
48. Fermenting Vats Used in Large Scale Manufacture of Vinegar from Fruits . . . . .	117
49. Barrel Arranged for Vinegar Making . . . . .	121
50. Plan for Upright Vinegar Generator for Farm Use . . . . .	122
51. Leo Acid Tester for Testing Strength of Vinegar . . . . .	124
52. Barrel or Other Container Arranged for Fermentation of Vegetables . . . . .	133
53. Preserving Vegetables by Salting . . . . .	134
54. Vats of Olives being Exposed to Air to Color Them during Pickling Process . . . . .	137
55. Interior of Large Olive Pickling Plant . . . . .	138
56. Home-Made Smoke House . . . . .	146
57. Capping and Tipping a Solder Top Can . . . . .	160
58. Horse Power Sorghum or Cane Mill . . . . .	195
59. Evaporating Pan for Sorghum and Other Sirups . . . . .	196
60. Apple Peeler for Farm Use . . . . .	212
61. Hand Power Vegetable Slicer . . . . .	220

PART I  
THEORY OF FOOD PRESERVATION



# HOME AND FARM FOOD PRESERVATION

## CHAPTER I

### WHY FOOD SPOILS

Food spoils because of the growth and destructive action of microscopic living organisms. They are commonly termed "germs." The various methods of food preservation are practically all based upon processes that destroy these organisms or prevent their growth and activity. Because they are microscopic and because they are living organisms, we shall for convenience call them "microorganisms."

**1. Molds.** The molding of food is a common phenomenon. In some cases the food is completely spoiled; in others, the decomposition is not sufficient to make the product inedible; and in a few products, the growth of certain molds is desirable.

The most prevalent mold and the one causing the most damage is the "blue mold," otherwise known as "*Penicillium expansum*." It first appears usually as a white cottony growth on fruits, cheese, cured meats, vegetables, jellies, wine tanks, leather left in dark closets, and on other articles favorable to its growth. This cottony growth of mold threads is known as a "mycelium." Later, the mold becomes "powdery" in appearance and green or blue in color. This change in color is due to the formation of billions of microscopic cells or "spores." The spores are very light and easily detached. They are carried by the air or other agencies from place to

place. They are floating in the air at all times and places and are present on the surfaces of all fresh foods. They are capable of sprouting when conditions become favorable. A large growth may start from a single cell or spore.

Fruits whose skins become broken in transit suffer badly from this mold and acquire a moldy taste and odor. In some such cases the growth will not be apparent because the mold threads are growing in the pulp or juice of the fruit.

The surface of jellies may become overgrown by this organism and the upper portion of the jelly completely spoiled. Leaky jars of fruit may mold from the growth of penicillium spores gaining entrance through the leaks. Bacon and cheese may develop green spots of this mold on the surface and still not be spoiled if the mold is removed in time. The inside of wine or vinegar barrels may be completely spoiled where this mold is allowed to develop through improper care of the barrels.

The blue mold can be controlled, but great care must be taken if it is to be completely eliminated. Its spores are killed by heating to 180° F. and growth is prevented by many chemicals.

“Black Mold,” otherwise known as “*Aspergillus niger*,” often occurs on fruits that have become moist on the surface or broken; or it may occur on other products occasionally. It does not produce a moldy taste or odor; it is much less prevalent, and is easier to control than is the blue mold.

“Pin Mold,” or “Gray Mold,” or “Bread Mold,” usually causes the molding of bread stored in a moist place. It also occurs frequently on fruits and may appear as “whiskers” on peaches, grapes, and other fruits, shipped long distances in boxes. It is not especially important in food preservation. It is known botanically as *Mucor*.

There are hundreds of other forms of molds but the above forms are by far the most common on food products.

Molds are not always deleterious in their action. Camembert, Rocquefort, and some other fancy cheeses owe their distinctive quality to the growth of special forms of *Penicillium* molds. A form of *Aspergillus* mold, known as *Aspergillus oryzae*, is used extensively in Japan in making "Saki," Japanese beer. A *Mucor* mold is used frequently in distilleries in the production of alcohol from cereals.

In general, molds are of interest in food preservation because of their capacity for spoiling food, their universal occurrence on food products, and the difficulty in killing their spores by heat or controlling their growth in other ways.

**2. Yeasts.** When a fruit juice is allowed to stand a few days it undergoes fermentation. The sugar is destroyed and alcohol and carbonic acid gas are formed. This change is brought about by another group of microscopic organisms, known as yeasts. Yeasts are used in bread making, vinegar manufacture, and in the production of various fermented beverages.

Unlike molds, they do not form a mycelium, *i. e.*, a thread-like growth, but only develop as microscopic cells of various forms. They appear in fermented liquids as a white sediment or a cloudy growth throughout the liquid.

They are universally present in the air, on the surfaces of fruits, vegetables, and of tables, knives, etc., and are capable of growing in and spoiling sugary liquids, crushed fruits, jellies that do not have sufficient sugar, and in other products containing from one to 65% sugar. More sugar than 65% prevents their growth.

Jars and cans of fruit that become leaky after sterilization become infected with yeast cells carried in by air

passing into the containers. Growth and fermentation take place and the pressure of the carbonic acid formed by the yeast causes the container to swell or burst. Much canned fruit is lost in this way. The housewife usually attributes the loss to the entrance of air. It is in reality caused by yeast gaining entrance with the air; air alone would be incapable of causing fermentation.

Yeasts are easily killed by heat, a temperature of 60° C. or 140° F. being sufficient, and in general, yeasts are more easily controlled than molds. Conditions that will eliminate molds will also remove yeasts.

Yeasts cause the "souring," "working," or fermenting of spoiled jars or cans of fruit, bottles of fruit juices, or glasses of jelly. They are therefore of much importance in the preservation of fruit products.

They are necessary in the manufacture of all fermented beverages, denatured alcohol, vinegar, and yeast-risen bread. Yeasts are the most useful of all the microorganisms met with in food preservation.

**3. Bacteria.** Milk sours on standing; meat and many cooked vegetables putrefy unless spoiling is prevented; dill pickles and sauerkraut undergo certain characteristic changes. These changes are wholly, or in most part, brought about by bacteria. They comprise the third main group of "germs" or microorganisms. Like the other two groups they are universally distributed. Bacteria are, as a rule, smaller than yeasts and differ from them in their method of reproduction. Yeasts reproduce by budding and bacteria by splitting in two, *i. e.*, by "fission." Bacteria prefer nitrogenous substances of low acid content, such as milk, meat, peas, and beans, and do not grow readily on fruits or acid vegetables. Molds and yeasts prefer sugary, acid materials.

Yeast and mold spores are easily killed by temperatures below 212° F. Many bacterial spores survive tem-



peratures above 212° F., the boiling point of water. For this reason, many foods containing such spores are exceedingly difficult to sterilize by heat. This does not apply to foods high in acid because these bacteria can not grow readily in the presence of much acid and are more easily killed in acid foods.

Yeasts and molds produce relatively harmless compounds in food products. Bacteria on the other hand may produce in canned vegetables, in meats, and in cheese, extremely poisonous compounds. These are the ptomaines and botulinus poison. (See paragraph 25, Part II, on "Spoiling of Canned Foods.") [It is therefore necessary to be sure that such products as canned peas, beans, corn, and meats, are thoroughly sterilized, in order that poisoning will not occur.

Several forms of bacteria are extremely useful in food preservation and food manufacture. The two most important are vinegar bacteria, necessary in making vinegar, and lactic acid bacteria, essential in the manufacture and preservation of sauerkraut, pickled green olives, silage, and cheese. "Vinegar Mother" is a growth of vinegar bacteria; the sour taste of sauerkraut and sour milk is brought about by lactic acid formed by lactic acid bacteria.

**4. Spoiling of Foods by Chemical and Physical Changes.** Some food products decompose without the action of organisms. Edible fats and oils become rancid through the action of the oxygen of the air. Meats are sometimes practically spoiled by the use of too much salt in salt curing. Dried fruits may be greatly injured by leaving them too long in the sun on trays. Canned goods sometimes act upon the tin of the cans to such an extent that they become poisonous or inedible.

Practically all food products undergo slow changes through drying or oxidation when left exposed to the

## 8 HOME AND FARM FOOD PRESERVATION

air. Even cereals deteriorate with age in bins, elevators, etc.

Changes of this sort are as a rule slower and more easily controlled than bacterial changes. It is usually only necessary to exclude moisture or air or control the temperature.

## CHAPTER II

### WAYS OF PREVENTING SPOILING

#### A. TEMPORARY PREVENTION OF SPOILING

It is often desirable to preserve foods for a relatively short time only. In such cases methods are usually employed, which will alter the original qualities of the product as little as possible. The methods will vary with the character of the food and other conditions.

**5. Asepsis.** Milk, fresh fruit juices and the surfaces of fruits, vegetables, meats, and other food products contain great numbers of microorganisms capable of causing spoiling. By handling these products in a careful and cleanly way, by using containers that are clean and preferably sterilized by heat, and by washing or otherwise cleansing certain products of adhering dust, etc., the molds, yeasts, and bacteria will be kept down to small numbers, and their multiplication will be hindered. Often such treatment will greatly prolong the keeping of food products, especially of fresh fruits and vegetables. Cleanliness and care in handling in order that excessive contamination by "germs" will be prevented is termed "asepsis." The extreme care taken in modern certified dairies in the production of certified milk is one of the best examples of the application of asepsis in the handling of a food product.

**6. Cold Storage.** The organisms that cause spoiling, grow most rapidly and are most active at warm temperatures. At temperatures near the freezing point their growth is almost completely stopped. The storage of eggs, meats, and fruits at low temperatures has become

an enormous industry. It has made these foods available over a longer period of the year than would otherwise be possible. Fresh meat is exported in great quantities from South America, Australia, and the United States in ships equipped with cold storage facilities.

Cold storage is principally an industrial undertaking but is used extensively in a small way by housewives and farmers in the use of the various forms of household ice chests and in the winter storage of vegetables on farms. Meat is often allowed to freeze in the winter air and is kept in a cold place till needed.

In all cases the principle involved is the same; namely, reducing the activity of the microorganisms of spoiling by a reduction of temperature. Lowering of temperature also slows up deleterious chemical changes such as the rancidifying of fats, and oils, and the deterioration of cereals.

**7. Exclusion of Moisture.** Moisture is necessary to the growth of microscopic organisms. Fruits often spoil during shipment because of the collection on their surfaces of moisture, in which molds develop. Perfectly dry surfaces will not support mold or other "germ" growth. For this reason, dried fruits, meats, dried vegetables, and cereals should be stored in a dry atmosphere. Cars for the shipment of fresh fruits are well ventilated in order that moisture in excessive amounts will not collect on the fruit, and permit growth of mold. The same principle applies to the storing of bread, meats, cereals, flour and many other foods. As in the shipment of fruit or the keeping of bread, exclusion of surface moisture involves ventilation; that is, a supply of circulating air to carry away any moisture given off by the food product.

**8. Use of Mild Antiseptics.** Food products may often be preserved a short time by the use of small amounts of antiseptics. These inhibit, that is, decrease or prevent

the activity of the organisms of spoiling but do not destroy them. For example, meat may be kept by the addition of salt. If small amounts are used, the preservation will be temporary; if large quantities are added, the meat will be permanently preserved. The same applies to butter preserved with salt. Sugar in amounts less than 65% exerts a temporary preservative effect. Small amounts of sodium benzoate are used in ketchups, etc., as a means of temporary preservation. Milk is sometimes illegally preserved temporarily by the addition of formaldehyde or borax in small amounts. These are examples of the use of various antiseptics as a means of temporary preservation.

**9. Pasteurization as a Means of Temporary Preservation.** By pasteurization is meant heating a food product to a temperature which kills most of the organisms present, but does not destroy all. It also greatly weakens those not killed and retards their normal development. The most familiar example of this method is in the pasteurization of milk. The temperature used kills typhoid and tuberculosis bacteria, but does not destroy certain spore-bearing bacteria. The milk so treated will usually be free from bacteria capable of producing serious diseases but will not keep permanently, because the spores of the resistant bacteria will finally develop and cause spoiling. Milk pasteurization for market dairy milk is compulsory in many cities and states. Many other food products are heated to keep them for a few days; for example, meats, cooked vegetables, jams, etc., are often so treated by simply heating them in an open pot. This preserves them for several days. Pasteurization may, then, be taken to mean the heating of a food product to a sufficiently high temperature to kill many of the microorganisms, but not all that are present, and results in temporary preservation only. It is usually carried out at temperatures below 212° F., the boiling point of water.

The term "pasteurization" is frequently applied to the sterilization of fruit juices or other products at temperatures below 212° F. In most of these cases, however, the products are actually sterilized; that is, all living organisms are killed. Sterilization thus differs from pasteurization in that sterilization is complete destruction of all life present and pasteurization is only destruction of part of the organisms present.

**10. Exclusion of Air.** The keeping qualities of some food products are enhanced if air is effectively excluded. This is true of pickles, such as dill pickles, and green olive pickles; also of butter, cheese, olive oil, wine, and vinegar. In some cases the effect is due to the exclusion of organisms, *e. g.*, eggs sealed with water glass or paraffin; in others, to the exclusion of oxygen necessary to the growth of molds or bacteria that would destroy such foods as pickles and wine, and in other cases to the exclusion of oxygen essential to the deleterious chemical changes that take place in such food products as olive oil and other vegetable and animal oils and fats.

The popular idea that air itself causes the spoiling of canned fruits, vegetables, and various other canned products by its entrance through leaks is erroneous. This can be proven by sterilizing food products in bottles plugged with cotton. Air can go in but "germs" are retained on the cotton. The sterilized product will keep indefinitely under these conditions. It is the growth of molds, yeasts, and bacteria gaining entrance with the air that causes spoiling.

## B. PERMANENT PREVENTION OF SPOILING

There are several important principles applied in the permanent preservation of food products. Like methods of temporary preservation, the process must be adapted to the product and the existing conditions. In the fol-

lowing paragraphs the most important principles are discussed.

**11. Preservation by Sterilization by Heat.** Sterilization by heat means complete destruction of all forms of life in the product sterilized. If the sterilized material is to be kept for any appreciable length of time, sterilization must be accompanied by sealing the product in air-tight containers. The exclusion of air is necessary in order that microorganisms shall not gain entrance to the food.

The temperature necessary for sterilization will depend almost entirely upon the composition of the food. Foods high in acid are very easily sterilized; those low in acid are difficult to sterilize. This rule holds, apparently without exception. Meats, milk, and vegetables of low acidity, such as peas, corn, pumpkin, and beans are exceedingly difficult to sterilize by heat. Acid products, such as most fruits and tomatoes, are easily sterilized. On all of these products are found numbers of spore bearing bacteria of great resistance to heat; but apparently in the presence of acid they are easily killed or are not able to develop. Regardless of which theory is true, it remains a fact that acidity very positively affects sterilizing temperatures. If products low in acid are acidified with some harmless acid substance such as lemon juice or vinegar, they will become relatively easy to sterilize. This principle is made use of in the "lemon juice method" described later.

Fruit juices and most fruits are readily sterilized by a few minutes' heating to 165° F.; pickled olives must be heated a short time at 212° F., the boiling point of water; string beans require two hours or longer at 212° F.; corn, three hours or longer at 212° F.; and meats, four hours or longer at 212° F. There is thus a gradation in the length of heating and the temperature necessary for complete sterilization.

Sterilization in boiling water at 212° F. is made more effective if the time of sterilization is broken up into two or three periods separated by intervals of 24 hours. For example, corn or meat may be readily sterilized by heating in cans or jars in boiling water for one hour on each of three successive days. Between the first and second heating, most of the spores that have survived the first heating will germinate because of the softening effect of the heat. These will be very tender and will be easily killed when the second heating occurs. The third heating will kill all the spores left from the second heating. This method is known as "intermittent sterilization," or the "three-day method." It is well adapted to the household sterilization of meats and certain vegetables. Its application is described later.

Steam confined in a closed space and heated will reach temperatures above 212°. The spores of bacteria, in or on products difficult to sterilize, will be quickly killed if the materials are confined in a steam retort and heated under steam pressure of several pounds per square inch. This method is used to the exclusion of all others in commercial canneries for the sterilization of such materials as peas, beans, corn, meats, and milk. It requires factory-made equipment, but simple inexpensive steam pressure sterilizers for home use are available. The home application of steam pressure sterilization will be discussed later.

**12. Preservation by Use of Antiseptics.** Salt, sugar, vinegar acid, and lactic acid are used commonly as preservatives for foods and prevent spoiling by their poisonous action upon microorganisms. These are all harmless antiseptics. Various chemicals are also used as food preservatives but most of them are considered harmful to health. Examples are benzoic acid, sodium benzoate, salicylic acid, formaldehyde, sulphurous acid, and sodium fluoride.



Sugar will prevent spoiling if it is present to the extent of 65%. Sirups, honey, jellies, candies, and marmalades do not spoil because they contain enough sugar to prevent molding or fermentation.

Salt must usually be present to the extent of at least 15% to act as a permanent preservative. An apparent exception would appear to be butter, where 5% is sufficient. But in this case, the real preservative effect of the salt takes place in the buttermilk and brine in the butter because the butter fat itself is inert and does not dissolve the salt. The liquid portion of the butter constitutes only 15% or less of the butter. Therefore, 5% of salt calculated on the weight of the butter would give a 30% solution in the liquid part of the butter. The same principle applies to other salted products. It is the salt in solution that exercises an antiseptic effect in the preservation of salted meats and salted vegetables.

Vinegar acid is a more effective antiseptic than salt or sugar. For most food products 3% acetic acid is sufficient to preserve them. Vinegar is used in the preservation of many forms of pickles.

Benzoate of soda is the most common and least harmful chemical preservative used. It is allowed by pure food laws in quantities up to one-tenth of 1%. It is used for the preservation of sirups and fruit preserves used in soda fountains and for the preservation of ketchup.

Sulphurous acid from the fumes of burning sulphur is allowed in small quantities in food products. Other chemical preservatives are prohibited by law and are therefore of little interest to the housewife and farmer. Sulphurous acid from burning sulphur is used in fruit drying to prevent darkening. Its use for this purpose is universal and is permitted by pure food laws. It is doubtful, however, whether the amount used is sufficient to act as a permanent preservative.

**13. Preservation by Drying.** Microorganisms that cause spoiling require a certain minimum amount of moisture for growth. If the moisture falls below this minimum in a food product the food will not spoil by molding, fermentation, or putrefaction. This principle is made use of in the drying of fruits, vegetables, and meats, and making desiccated liquids, such as desiccated milk, dried coffee extract, etc.

The amount of evaporation necessary will depend upon the composition of the food. Foods impregnated with salt need not be dried so much as those not containing salt, because the salt exerts an antiseptic effect in addition to the preservative effect of the drying. The same applies to smoked meats. Fruits and vegetables must be dried to the point where the juice or sap in the dried product contains more than 65% sugar, or its equivalent in other soluble compounds. It is actually the high concentration of sugar in these cases that exerts the preservative action. This point will be reached for prunes and figs when  $2\frac{1}{2}$  pounds have been dried to 1 pound; for apricots, peaches, and pears, when about 5 or 6 pounds have been dried to 1; for grapes, about 4 pounds to 1; for beets, about 7 to 1; for turnips, carrots, and tomatoes, about 14 to 1; and for onions, about 16 to 1. The ratio will depend upon the original water content of the product dried. This varies with the locality, method of growing, degree of ripeness, and other conditions.

In practice the dried products are not dried by determining the loss in weight, but they are dried until the texture is attained at which experience has shown that the product will keep.

**14. Preservation by Smoking.** Meats are smoked to impart an agreeable flavor and to preserve them. The preservative action is brought about principally by the antiseptic effect of compounds of a creosotic nature

existing in the smoke, but is also due in part to the drying effect of the heat accompanying the smoking process.

**15. Preservation by Fermentation.** Microorganisms usually cause spoiling, but under certain conditions and with certain food products, their activity can be utilized as a means of food preservation. Preservation of foods in this manner may be accomplished by the action of a number of different microorganisms, which carry on various sorts of changes in the food product. These changes are designated as fermentations, the term including alcoholic fermentation, vinegar fermentation, and lactic acid fermentation.

Fruit juices may be changed to wines and hard ciders by yeast fermentation. If air is excluded the fermented products will not spoil, because of the preservative effect of the alcohol, and also because the yeast has destroyed the sugar and other food compounds upon which other organisms might develop.

Vinegar is formed by acetic acid fermentation of alcoholic liquids. This fermentation is carried on by vinegar bacteria. The acetic acid formed will preserve the liquid itself, or fruits, vegetables, and meats stored in the liquid, provided air is excluded after vinegar fermentation is over. The acetic acid of the vinegar is the preservative agent.

Lactic acid fermentation occurs in the manufacture of sauerkraut, fermented string beans, and similar fermented vegetables. It is carried out by lactic acid bacteria, which form lactic acid from the sugar of the vegetables. Vegetables so fermented will keep indefinitely after lactic fermentation is over, provided air is excluded. Silage owes its keeping qualities largely to lactic acid formed by lactic acid fermentation in the silo.

**16. Exclusion of Air.** Certain food products are spoiled by the action of the oxygen of the air. Oils and

fats are of this type. Such products will not spoil if air is excluded.

Other food products are spoiled by the combined action of various microorganisms and the air. Wine, eggs, and vinegar belong to this class. If eggs are sealed with water glass they will keep for a year or longer. If wine and vinegar are sealed in completely filled bottles they will keep for scores of years. Therefore, the simple exclusion of air may be termed a means of permanently preserving some food products.

PART II

METHODS OF FOOD PRESERVATION

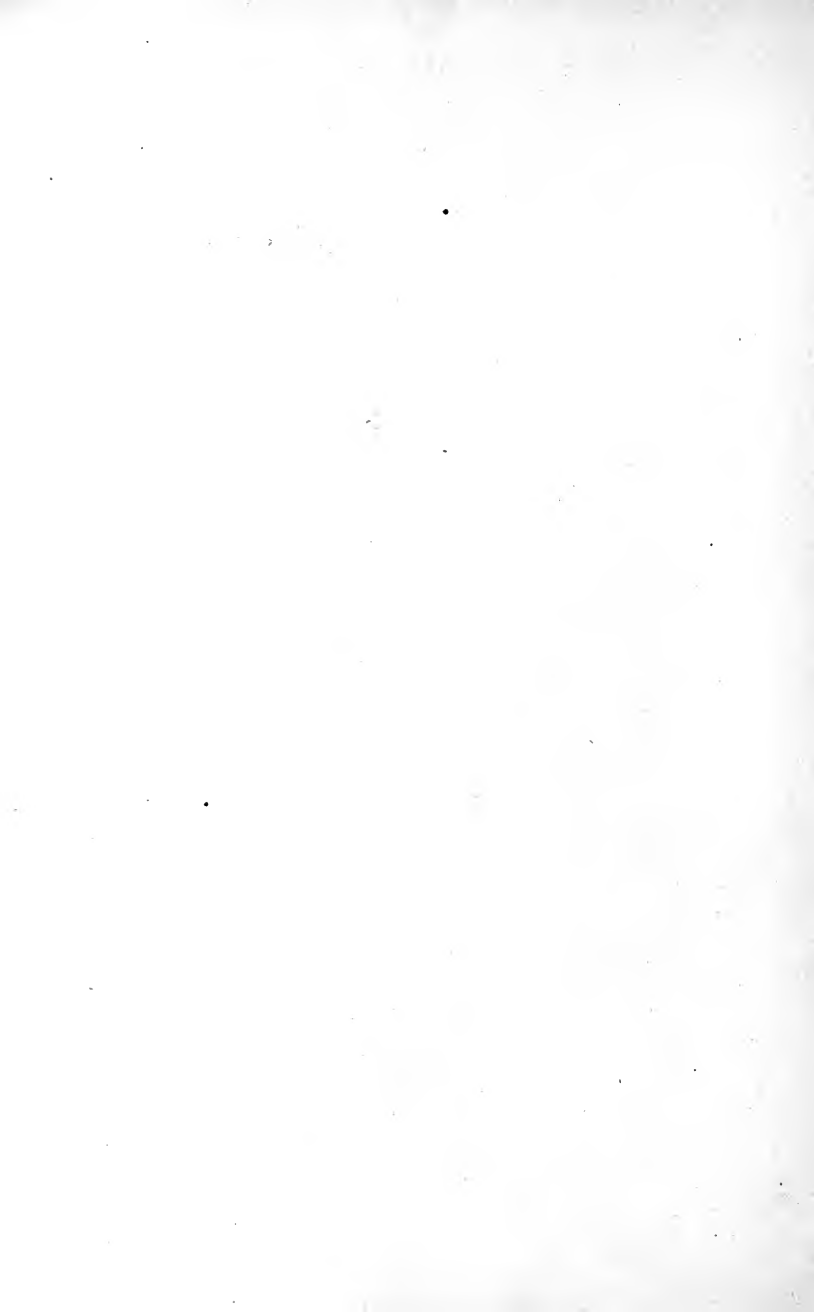

## CHAPTER III

### CANNING FRUITS

Fruit canning is one of the most important of the food preservation industries. It is no longer a by-product industry, but is now a primary industry for which enormous quantities of fruit are grown annually.

In addition to the fruit canned commercially, many millions of cans and jars are put up each year by housewives in the kitchen or by families who use small scale canning outfits. It is for those engaged in canning for home use or in a small way for local sale that the following discussion is intended, although the principles involved will be of interest to commercial fruit canners.

The various steps in the canning process have been taken up in the order in which they occur in practice and each is discussed separately. For convenience of reference, the various topics taken up have been numbered serially. The material in this chapter is general and aims to give the principles of canning and descriptions of apparatus used rather than specific directions or recipes. Recipes will be found in Part III, Recipes 1-19, inclusive.

**1. Picking.** Fruits for canning should be prime ripe; not over-ripe and soft, or too green. An exception to this rule is the pear. Pears should be picked when full size, but still green and should then be ripened in the box because tree ripened pears lack flavor and are coarse in texture. Under-ripe apricots remain astringent and tasteless regardless of the amount of cooking or sugar used.

The fruit should be handled carefully to prevent

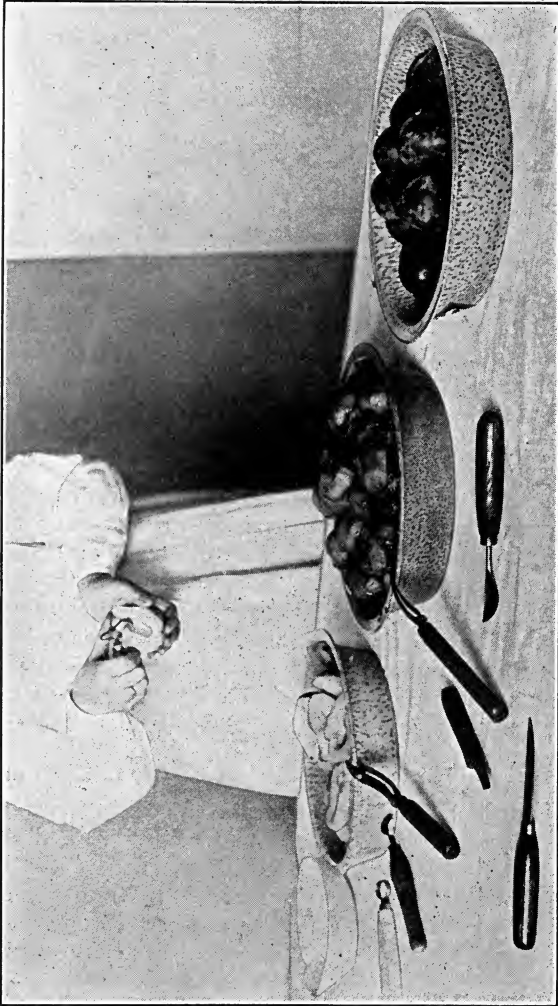

Fig. 1. Preparing Fruit for Canning.



bruising. Berries and soft fruit should be kept in shallow boxes until canned.

The fruit should be taken to the canning room as soon as picked. In most fruits, there is a rapid deterioration both in texture and flavor after picking.

**2. Grading and Sorting.** The appearance of the canned fruit is greatly improved by sorting the fruit according to appearance and grading for size. In home canning all grading can be done by hand and at the operator's discretion. Where large quantities of fruit are to be graded for size, the grading for size is done by mechanical graders that can be adjusted to different varieties of fruit.

In home or small scale canning three grades will usually be sufficient: "Fancy," consisting of the finest and largest fruit; "Standard," medium sized fruit, and this grade may also include fruit that is more or less imperfect in appearance but of good size; "Pie Fruit," soft, small, and badly blemished fruit.

Grading is highly desirable if the fruit is canned for sale.

**3. Peeling, Pitting, Coring and Cutting.** Large fruits for home canning are peeled, usually by hand with a knife, although small hand power peelers for apples and peaches are available. The Pomona and similar types of peeling knives fitted with a guard will tend to prevent waste of fruit in peeling (Fig. 2).

Peaches and apricots are peeled commercially by immersing them in a boiling 10% solution of soda lye. The method is rather difficult to use in the household. A modification of this method of peeling can be used on a small scale as follows: Make a solution of three-fourths of a pound of soda lye per gallon of water. Use an agateware or iron pot; never aluminum. Heat to boiling. Immerse the fruit in a wire basket in the hot lye long enough (about 20 to 30 seconds), to soften the skin.

Plunge fruit into large pot of cold water and rub off skins with the hands. Wash off all trace of lye in another pot of water. Vigorous washing will be necessary to remove the last traces of lye from the fruit.

Cherries are often pitted. Small hand pitters can be bought at any good hardware store for fifty cents to a

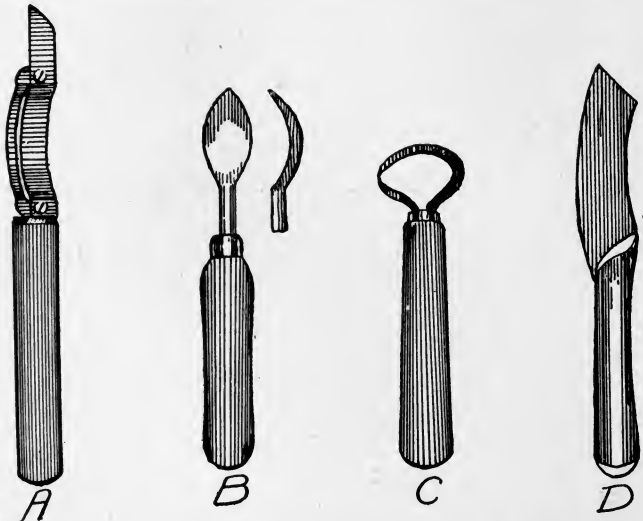

FIG. 2. Types of Knives for Preparation of Fruit. A. Pomona peeling knife with guard to regulate thickness of peelings. B. Peach pitting spoon. C. Pear coring knife. D. Fruit cutting knife.

dollar. These same pitters can also be used for olives. The pitters consist of a small plunger with a cross-shaped point that forces out the pit.

A convenient cutting knife for halving peaches, pears, etc., is shown in the accompanying figure.

The pits of clingstone peaches must be removed with a special pitting knife or "spoon." The flesh is first cut along the line of suture with a cutting knife. The pitting

spoon is then forced into the peach at the stem end and is manipulated so that the pit is cut from the flesh with as little loss as possible of flesh adhering to the pit. The fruit is then cut in half and is separated from the pit. Commercially, the halves are not peeled before pitting and the peeling is done later in a lye vat; in the household, it is advisable to peel cling peaches by hand before pitting.

Pears are hand peeled; they are cut in half and the core removed with the coring knife shown in Figure 2-C.

**4. Jars.** Because they can be used repeatedly from year to year, jars are more satisfactory than cans for putting up fruits in the household. There are numerous types and sizes of glass jars. Most of these give satisfaction if used properly. Their choice is largely a matter of personal preference.

The various brands of jars that are equipped with glass tops, rubbers, and wire clamps are very satisfactory because of their durability, their simplicity, wide openings for filling, convenience in sterilizing, and because of the fact that no metal comes in contact with the food and it is not necessary to replace the caps, as is often the case with some other types of jars. The various modifications of the Economy jar are excellent, if their use is well understood. They are sealed with a lacquered metal cap carrying a composition which melts during sterilization and hardens to form an air-tight seal as the jars cool. The caps can be used only once.

The ordinary Ball Mason jar is probably the most

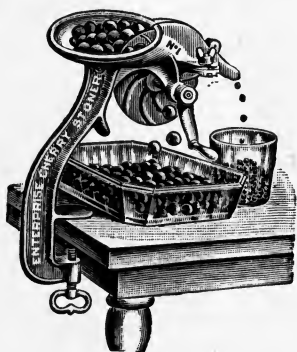

FIG. 3. Cherry Pitter for Home Use. (Courtesy of Berger and Carter Company, San Francisco, California.)

commonly used of all jars. The lacquered metal caps are superior to the old style porcelain and zinc cap. This latter style corrodes in time and becomes leaky. The main objection to the Mason jar is the narrowness of the jar mouth. A wide mouth Mason is now on the market but the caps are very difficult to remove and must usually

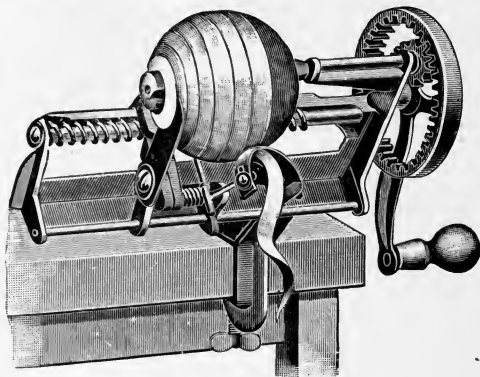

FIG. 4. Apple Peeling Machine for Home Use.  
(Courtesy of Berger and Carter Company,  
San Francisco, California.)

be replaced each year. The new Mason with the so-called "vacuum seal" is excellent.

More important than the jar is the rubber. Select rubbers of the best material. Before buying, test them by stretching them severely. Brittle rubbers will not stand processing; they will often spread and cause leaks that result in spoiling of the contents of the jar. Rubbers of good elasticity will often last two seasons. It is, however, a good plan to buy new rubbers each season rather than to risk spoiling through the use of old rubbers. It is sometimes possible to use two old rubbers to each jar with good results.

**3. Wax Top Cans.** Three types of cans are used in

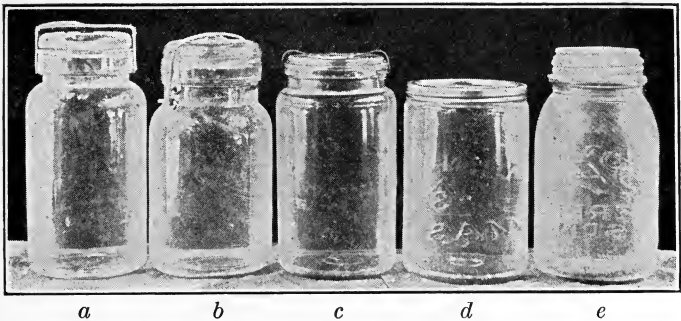

FIG. 5. Common Types of Jars. *a*, Glass top with removable clamp. *b*, Glass top with fixed wire clamp. (Atlas, E. Z. seal, etc.) *c*, Metal cap, composition seal. (Economy, etc.) *d*, Metal cap, rubber seal, wide mouth. (Golden State, Mason, etc.) *e*, Ordinary Ball Mason.

home and farm canning. These are the wax top can, the solder top can, and the open top or Sanitary can.

The wax top can is fitted with a groove around the edge of the top. The lid fits into this and the seal is made after sterilization by pouring hot sealing wax to fill the groove or by filling the groove with a specially prepared waxed string. The wax top cans are excellent for fruits

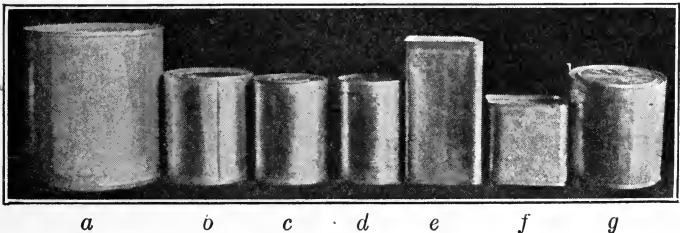

FIG. 6. Common Types of Cans for Home Canning. *a*, Solder top can No. 10 size. *b*, Solder top can No. 3 size. *c*, Solder top can No. 2 size. *d*, Solder top can No. 1 tall size. *e*, Solder top can No. 2½ tall square asparagus. *f*, Solder top can, flat asparagus. *g*, Wax top can.

but are not very satisfactory for vegetables or meats, because of the difficulty in sealing the cans while still boiling hot. It is possible to permit the cans to cool slightly before sealing when used for fruit and then no difficulty is met with in applying the wax. Advantages of the wax top can are its wide opening through which large fruits and whole tomatoes may be filled into the can and the fact that the cans may with care be used

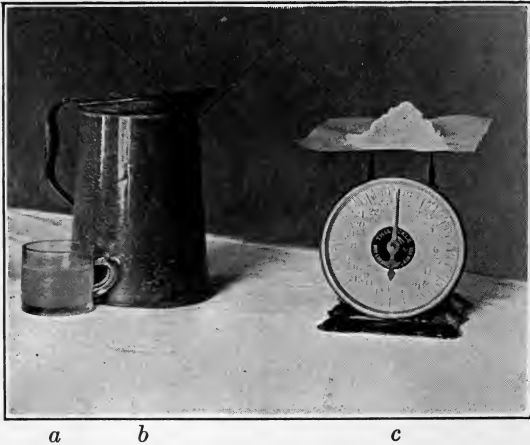

FIG. 7. Useful Utensils in Canning. *a*, Measuring glass, 8 ounces capacity. *b*, Half gallon measure. *c*, Household scale.

several seasons. The sealing is very simple and requires no special equipment or experience.

**6. Solder Top Cans.** Solder top cans are closed with solder. The cap of the solder top can is soldered on with a special soldering steel after the can is filled. It is sealed by closing a small vent hole in the center of the can with a drop of solder. Two styles of caps may be obtained. The solder hemmed cap has a ring of solder attached.

The lid is soldered to the can by simply melting this ring of solder. The plain caps have no hem of solder and solder must be melted against the capping steel. This is wasteful of time and solder. Solder hemmed cap should be used if they can possibly be procured. The sealing of solder top cans is described in a recipe and illustrated in Fig. 56.

**7. Cooking the Fruit before Filling the Containers, or Hot Pack Method.** There are two ways of canning fruits. These are known as the "cold pack" and the "hot pack" methods, respectively. In the cold pack method the fruit is packed into the jars or cans immediately after peeling, pitting, etc.; sirup or water is added and the fruit is cooked in the container. The fruit holds its shape and flavor well in this method but some fruits contract a great deal during sterilization, leaving the jar or can unfilled. In the hot pack method this contraction takes place outside the container and more fruit can be packed into each can or jar. It is therefore a more economical method for home use.

The fruit is prepared for the can by grading, peeling, coring, and pitting as the case requires. For sour fruits, one-half cup of sugar is added to each cup of fruit; for sweet fruits one-fourth cup; for pie fruit, no sugar. Just enough water is added to prevent scorching. The fruit is cooked over a slow fire with very little stirring until about half cooked.

By means of a ladle and wide mouthed funnel it is poured into scalded jars or cans and sterilized.

This method differs from the usual household "hot pack" method in which the fruit is completely cooked before placing it in the jars and in which no further cooking is given. The method of cooking completely before packing into cans or jars results in considerable breaking of the fruit and gives a less attractive appearing product.



FIG. 8. Blanching and Chilling Vegetables before Canning.

**8. Filling Jars and Cans without Previous Cooking of the Fruit—Cold Pack Method.** The fruit is prepared by peeling, coring, and pitting. It is packed into jars or cans without cooking. Hot sirup or water is added according to the grade of fruit. Sterilization and cooking are carried out in the cans or jars. This method is used exclusively by commercial canneries and is recommended strongly by the United States Department of Agriculture and the State Experiment Stations for use in the household. It is the least laborious of any method, but is not best for household use, because it does not utilize all of the space in the jars or cans, because considerable shrinkage occurs during sterilization. Partial





FIG. 9. Filling Jars with Heated Fruit. (Posed by Miss Marjorie Clark.)



FIG. 10. Filling Jars with Hot Brine or Sirup before Lowering Them into Sterilizer.

cooking of the fruit before canning and sterilizing gives better results in the kitchen.

**9. Sanitary Cans.** This is the type of can used in commercial canneries. No solder is used in sealing it. The cap is crimped or spun on by a special machine after the cans are filled.

The commercial sanitary capping machine costs

several hundred dollars or is rented by can companies for about fifty dollars per season. A motor or other mechanical source of power is necessary to run the capping machine.

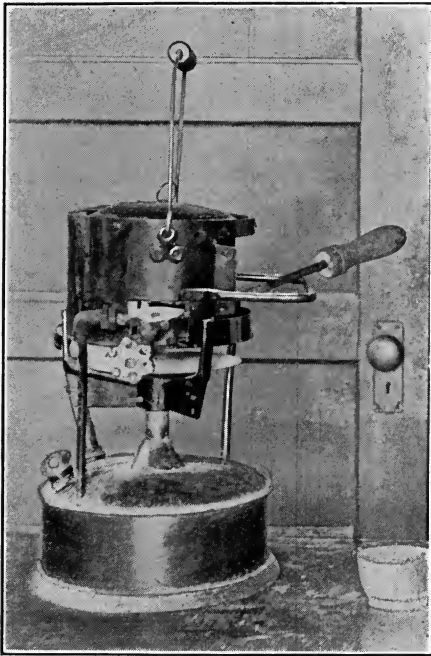

FIG. 11. Gasoline Fire Pot for Heating Soldering Irons.

Small hand power capping machines costing from \$13 and upward are available. Considerable skill and experience are required to make their use a success. With care and practice, however, satisfactory results can be attained. Directions for the use of these machines ac-

company them. One form of hand power sanitary can capping machine is shown in Fig. 13.

**10. Sizes of Cans.** Cans for food preservation vary in size from about one-fourth of a pint to five gallons. The sizes are usually designated by numbers rather than by "quarts," "pints," or "gallons." The contents of solder top cans and sanitary cans of the same numbers do not exactly correspond. The following table gives the contents of the various sizes of sanitary and solder top cans:

TABLE 1. DIMENSIONS AND CAPACITIES OF USUAL CANS <sup>1</sup>.

No.	SANITARY			SOLDER TOP	
	Height	Diameter	Capacity	Height	Diameter
1	4 in.	2 <sup>3</sup> / <sub>8</sub> in.	11.6 oz.	4 in.	2 <sup>11</sup> / <sub>16</sub> in.
2	4 <sup>1</sup> / <sub>2</sub> "	3 <sup>3</sup> / <sub>8</sub> "	21.3 "	4 <sup>9</sup> / <sub>16</sub> "	3 <sup>3</sup> / <sub>8</sub> "
2 <sup>1</sup> / <sub>2</sub>	4 <sup>11</sup> / <sub>16</sub> "	4 "	31.2 "	4 <sup>3</sup> / <sub>4</sub> "	4 "
3	5 "	4 <sup>1</sup> / <sub>4</sub> "	35.0 "	4 <sup>7</sup> / <sub>8</sub> "	4 <sup>3</sup> / <sub>16</sub> "
10	6 <sup>5</sup> / <sub>16</sub> "	6 <sup>1</sup> / <sub>8</sub> "	107.0 "	6 <sup>7</sup> / <sub>8</sub> "	6 <sup>1</sup> / <sub>4</sub> "

<sup>1</sup> From Circular 158, University of California Experiment Station, page 10. Dimensions in inches and capacities in fluid ounces.

**11. Net Weights that Cans for Market Must Contain.** Cans or jars of fruit for market are packed according to weight. The net contents of the containers must be declared on the label and the contents must equal or exceed the amount declared. Commercial canneries provide counterpoised scales and fill the cans according to weight. During sterilization the weight will decrease because of the shrinkage of the fruit in the sirup. The label must therefore state the net contents based on weight of the fruit when the can is opened after sterilization and this must be taken into account when filling the cans.

Dr. A. W. Bitting has done a great deal of work upon the net contents of cans of fruit and has published tables

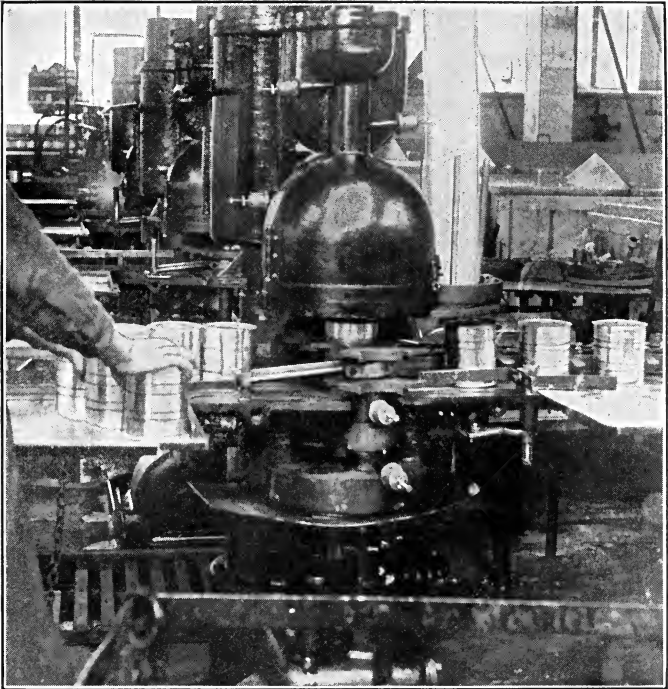

FIG. 12. View in Modern Cannery. Sealing Cans.

showing the relations between the fresh weight of fruit placed in the cans and the weight on the "cut out"; that is, when the can is opened several weeks or longer after sterilization. The weight immediately after sterilization will not be the same as that several weeks after sterilization because of the equalization of sugar in the sirup and fruit that takes place slowly after sterilization.

To determine the weight of fruit in a can, the can is opened and the contents are drained on a screen, or the top is cut and the fruit drained by inverting the can. .

The contents are stated either as net weight of fruit or as total weight of fruit and sirup.

The following table gives the relation between the weight of fruit placed in the can before sterilization and that some time after sterilization, for various fruits and sizes of cans. The table is based on results published by Dr. A. W. Bitting in Department Bulletin 196 of the United States Department of Agriculture.

TABLE 2. RELATION BETWEEN SIZE OF CAN AND WEIGHTS OF FRUIT BEFORE AND AFTER STERILIZATION

Fruit	Size of Can	Sugar Per Cent of Sirup	Original Weight of Fresh Fruit gms.	Weight of Fruit After Sterilization and Storage	
				Grams	Ounces
Apricot . . . . .	2½	Water	550	545	18
" . . . . .	2½	20	550	548	18
" . . . . .	2½	40	550	556	18½
" . . . . .	2½	60	550	513	17
Peach . . . . .	2½	Water	560	535	17¾
" . . . . .	2½	20	560	545	18¼
" . . . . .	2½	40	560	558	18¾
" . . . . .	2½	60	560	514	17
Pear . . . . .	2½	30	560	544	18
Loganberry . . . . .	2½	50	550	426	14¼
Strawberry . . . . .	2½	50	500	357	12
Plum . . . . .	2½	40	560	550	18¼
Royal Anne Cherries	2½	30	550	518	17¼

The weights of fresh fruit in Column 4 may be taken as the proper amount to weigh into the cans of this size before sealing, if the fruit is for market; because the figures were obtained upon fruits packed in the usual commercial way and represent average conditions. The net contents to be published on the label would be obtained from Column 5. Five hundred and fifty grams

corresponds to  $18\frac{1}{2}$  ounces; 560 grams to  $18\frac{3}{4}$  ounces; and 500 grams to  $16\frac{3}{4}$  ounces.

**12. Sirups and Hydrometers.** In commercial canning, fruits are packed in the cans before cooking. A sirup is added and the fruit is cooked in this sirup in the can. The sirups are made to contain various percentages of sugar, according to the various grades and varieties of fruit.

The sirups are tested before use by means of a sugar hydrometer or saccharometer. There are two general makes of hydrometers; namely, those which indicate the per cent of sugar directly, and those which indicate the Baumé degree, which is approximately one-half the real per cent of sugar. The Brix and Balling hydrometers indicate actual per cent of sugar.

The hydrometers consist of a glass tube with a long narrow stem at the top and an enlarged lower end weighted with shot or mercury. The upper stem carries a scale marked either in per cent sugar (Balling or Brix degrees) or in degrees Baumé. The instruments sink to 0 in water. Liquids containing sugar or other materials in solution exert a greater buoyant effect than water and the instrument rises in proportion to the amount of sugar present.

To use the instrument, a tall glass jar or cylinder is filled with the sirup. A tall green olive jar or a tall narrow flower vase will do for a cylinder. The hydrometer is inserted and the degree indicated at the surface of the liquid is read. (See Fig. 32.)

The sirup should be cool when the test is made because high temperatures cause the reading to be too low.

The hydrometer need not be used in household canning. Sirups can be made up accurately enough for this purpose by making use of the following table. For each gallon of water used in making the sirup weigh out the amount of sugar given in Column 3 of the table and

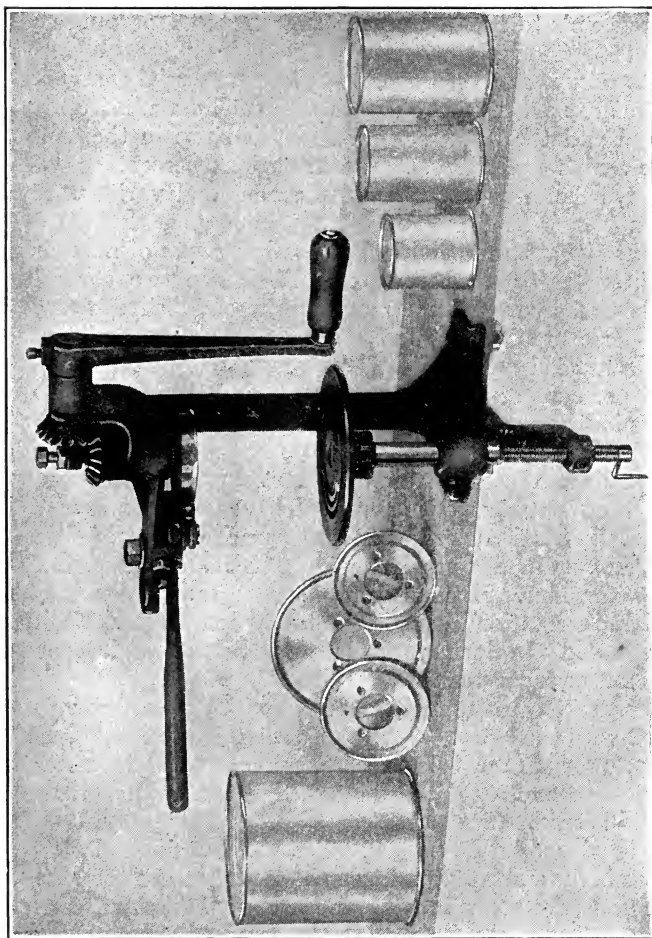

Fig. 13. Hand Power Capping Machine for Sanitary Cans. (Courtesy of Henninger and Ayes Company, Portland, Oregon.)



dissolve in one gallon of water. To use Column 4, measure out the amount of sugar indicated and dissolve in one quart of water.

TABLE 3. AMOUNTS OF SUGAR TO USE PER GALLON OF WATER TO GIVE SIRUPS OF VARIOUS PERCENTAGES OF SUGAR <sup>1</sup>

<i>Per Cent Sugar (Degree Brix or Ballings)</i>	<i>Degree Baumé</i>	<i>Amount of Sugar per Gallon of Water</i>	<i>Number of 8-Ounce Measuring Cups of Sugar per Quart</i>
5.....	2.8	7 oz.	1/8
10.....	5.5	15 "	3/8
15.....	8.3	1 lb. 8 "	1/2
20.....	11.1	2 " 2 "	3/4
25.....	13.8	2 " 13 "	1
30.....	16.5	3 " 10 "	1 1/8
35.....	19.2	4 " 7 "	1 3/8
40.....	21.9	5 " 10 "	1 3/4
45.....	24.6	6 " 14 "	2
50.....	27.2	8 " 6 "	3
55.....	29.8	10 " 4 "	4
60.....	32.4	12 " 10 "	5
65.....	34.9	15 " 11 "	6

<sup>1</sup> From Circular 158, University of California Experiment Station. Page 15.

The sirup in home canning is added boiling hot to save time in sterilizing and to avoid the necessity of "exhausting." See paragraph 14. The sirup may be heated in a teapot and poured directly into the jars or cans. It should be poured down through the center of fruit packed in jars rather than against the sides of the jar. This will prevent breakage. (See Fig. 10.)

**13. Cane vs. Beet Sugar.** An unwarranted prejudice exists against beet sugar for canning. Cane and beet sugar are one and the same thing chemically and modern

factory methods produce beet sugar of just as good quality as the best cane sugar. Both are used in commercial canneries with equally good results.

A number of years ago beet sugar was in some cases poorly refined and occasionally of poor flavor on this account. This condition no longer exists and beet sugar can be used for canning, jelly making, preserves, marmalades, etc., to just as good advantage as cane sugar.

**14. Exhausting.** If fruit is put up in solder top or sanitary cans (see Recipe 1, Part III), the contents of the can should be hot when it is sealed. In commercial canneries, this condition is attained by heating the cans and contents after the can is filled and before it is closed. The same effect is obtained in home canning by adding boiling hot sirup or water to the fruit in the can.

Exhausting or the addition of hot sirup expands the contents of the can. The can is then sealed and sterilized. On cooling, the contents contract again and form a vacuum in the can. Hence the origin of the term "exhausting." The vacuum formed in the can causes the ends to be drawn in slightly. If spoiling should occur, gas is formed in the can and the edges bulge out. Thus, a can of fruit with ends slightly drawn in is known to be good. This is the principal reason for exhausting cans, or adding boiling hot sirup before sealing them.

In exhausting solder top cans, the fruit and sirup are placed in the can cold. The cap is sealed on the can as directed in Recipe 1, but the vent hole is left open. The cans are placed in boiling water to about three-fourths the depth of the cans. A washboiler or other sterilizer can be used. They are left approximately five to ten minutes depending on the size of the can. They are then removed and the vent hole is closed or "tipped" with a drop of solder. The can is then ready for processing.

To exhaust sanitary cans, one proceeds as with solder

top cans, but does not place the lid on the can until after exhausting. Then it is sealed in a sanitary capper such as the one shown in Fig. 13.

**15. Sterilization of Fruits.** Sterilization is the destruction of all living microorganisms in the product sterilized.

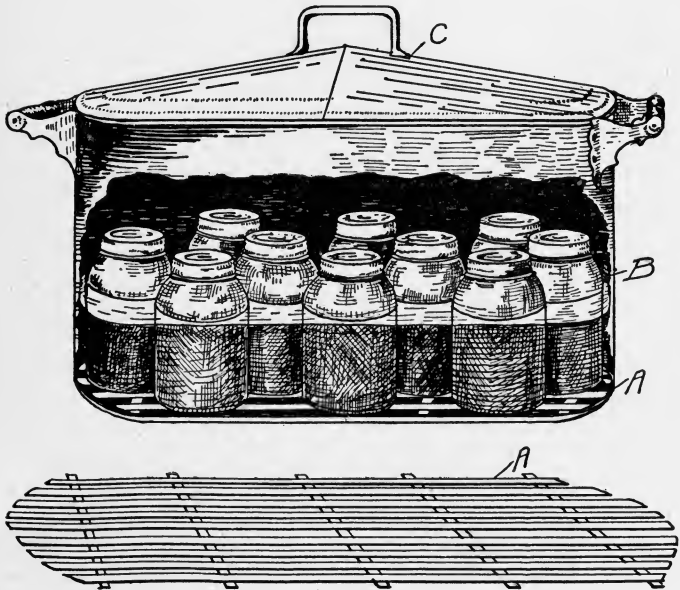

FIG. 14. A Convenient Form of Washboiler Sterilizer. A. False bottom of wooden slats. B. Jars on false bottom, showing level of liquid outside of jars; lids on loosely. C. Tight fitting lid for boiler.

It is usually accomplished by heat and accompanied by hermetic sealing so that the contents of the container will not become re-infected with microorganisms.

Fruits, because of their high acidity, are easily sterilized by heat; a temperature of 165° F. being sufficient.

However, since it is usually desirable to cook the fruit at the same time, the sterilization is carried out at the boiling point, *i. e.*, 212° F.

The old household method consisted in cooking the fruit in a pot and pouring it boiling hot into scalded cans or jars and sealing at once without further treatment. This method is unsafe because often the jars and caps do not get thoroughly sterilized by the hot fruit, and spoiling results.

Sterilizing the fruits in the container is much safer and more economical of time and labor. Any form of sterilizer in which the cans or jars may be subjected to the temperature of boiling water for the desired length of time may be used.

A very simple sterilizer for home use may be made by placing a false slat or screen bottom in a washboiler. The jars rest on this false bottom to protect them from the direct heat of the flame. (See Fig. 14.) A very convenient frame for holding jars in a washboiler may be bought in the form of a rack used ordinarily for boiling clothes. Figure 16 illustrates such a rack. This also acts as a false bottom. It is improved by soldering a wire guard on the sides of the rack to hold the jars in place.

In using a washboiler sterilizer the jars are filled with fruit and hot sirup or water is added, the lids and rubbers placed on loosely, enough water is added to the boiler so that when the jars are placed in it the water will rise to about two-thirds the height of the jars, the water is heated to the temperature of the jars or a little higher, the jars are placed on the false bottom, the cover is placed on the boiler, the water is heated to boiling, and boiled for the length of time desired for the particular fruit to be sterilized. *The time is counted from the time the water is actively boiling.* The tops of the jars are heated by the steam. If the lid of the boiler

fits imperfectly a towel may be placed between the lid and boiler top to make the seal more perfect. (See Fig. 15.)

The jars after sterilization are removed at once and the caps are tightened. If the false bottom or rack is equipped with handles the removal of the hot jars is



FIG. 15. Washboiler Sterilizer with Cover Made Tight by Use of a Cloth. This is a very effective method of covering boilers that have poorly fitting covers.

greatly facilitated. Jar tongs may also be used to lift the jars from the hot water.

The length of time of sterilization will vary with different fruits and with the maturity of the fruit. This variation is because of the differences in texture; not because some fruits are harder to sterilize than others.

Firm fruits, such as certain varieties of clingstone peaches, and pears, require a longer time than softer fruits, such as most freestone peaches and plums. The length of sterilization for various fruits is taken up under the recipes for each fruit.

Various forms of commercially made sterilizers for fruits may be purchased. These give satisfactory results and where very large quantities of fruits are to be canned their use may become desirable. There are types of commercial sterilizers designed primarily for the sterilization of vegetables and meats under steam pressure, but which can also be used for fruits. These are discussed under paragraph 21, Sterilization of Vegetables. (See Fig. 18.)

## CHAPTER IV

### CANNING VEGETABLES

As a rule, vegetables are more difficult to can successfully than are fruits. However, if the fundamental principles involved are well understood, good results may be uniformly obtained in canning all vegetables with ordinary kitchen equipment. The difficulties of vegetable canning and methods of overcoming these difficulties are taken up in the following paragraphs.

A great deal of interest has been taken recently in vegetable canning, because of cases of fatal poisoning from the use of home canned vegetables. These poisonings have been caused by a very powerful toxin produced in jars or cans of improperly sterilized vegetables by the growth of an organism known as *Bacillus botulinus*. Experiments and experience have shown, however, that the methods described in this book are perfectly safe. All that is necessary is that the methods be well understood and applied intelligently.

**16. Peeling and Preparing.** Vegetables for canning should be as fresh as possible. Waste no time in getting the vegetable from the garden into the can. Asparagus becomes tough and bitter if held twenty-four hours. String beans lose flavor and crispness; peas may ferment; and corn loses in flavor and sweetness if kept too long uncanned after gathering. The vegetables should therefore be canned on the same day that they are picked.

Vegetables should usually be graded for size and appearance. The amount of grading will depend on whether the product is for home use or for sale. Grade asparagus into two or three sizes and peas into young tender pods

and larger, more mature pods. Other vegetables need not be graded, unless for sale. In this case select the material of best appearance for canning for market and the less attractive vegetables for home use.

The vegetables should be thoroughly washed to remove earth, etc. A large tub may be used for this.

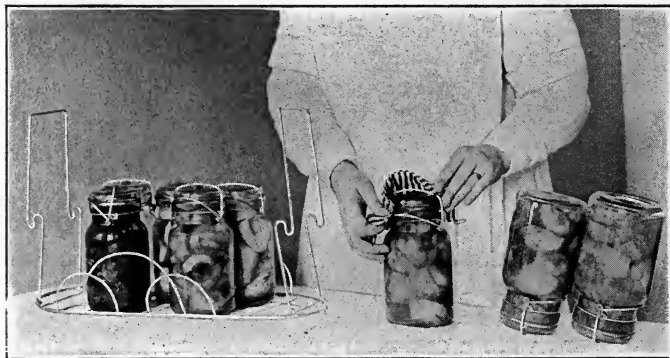

FIG. 16. Closing Jars after Sterilizing. *a*, Convenient rack to hold jars in sterilizer; this is known as a rack for boiling clothes; any hardware store can get one for you. The jars can be raised or lowered by it and it also serves as a false bottom. *b*, Pressing down the clamp of a glass top jar. *c*, Jars cooling.

In small scale canning the peeling, cutting, and preparation for the can must in practically all cases be done by hand. Root vegetables such as beets, turnips, and carrots, may be peeled by the peeler shown in Figure 43. In canning factories, peas are threshed and graded by machinery, while corn is silked and cut from the cob by special machines. Other vegetables are prepared largely by hand labor.

**17. Blanching or Parboiling.** Most vegetables are given a short preliminary boiling in water after grading, cutting, and peeling. This improves the texture and



color and usually removes disagreeable flavors and mucilaginous substances from the skins. The process is spoken of as "blanching," but is nothing more nor less than parboiling.

The prepared vegetables are placed in a screen basket or in a cheesecloth and plunged into vigorously boiling

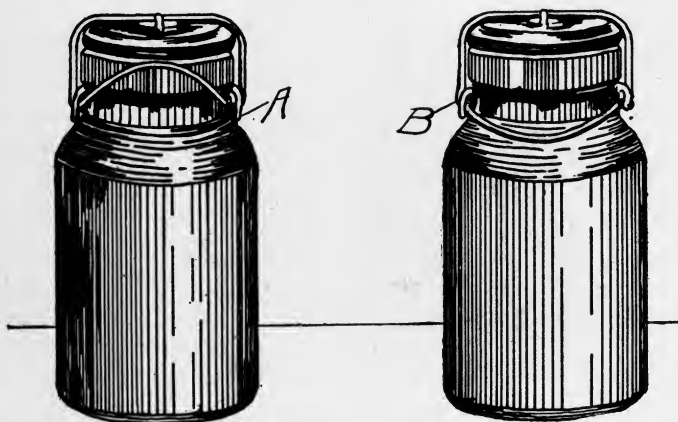

FIG. 17. Positions of Clamp on Glass Top Jar before and after Sterilizing. A. Before and during sterilization. B. After sterilization.

water for a length of time varying from a few seconds to ten minutes, the time depending on the vegetable and its degree of maturity. Small green peas will require less than a minute, while large stalks of asparagus may require ten minutes' blanching. Blanching cooks the vegetables more rapidly than cooking in the can, and tough vegetables can be made tender with less trouble in the blanching process than in the sterilization process. Convenient methods of blanching are illustrated in Fig. 8. Tomatoes are parboiled or steamed about one minute and beets about fifteen minutes to cause the



FIG. 18. Home Size Steam Pressure Sterilizer. (Courtesy of Henninger and Ayes Company, Portland, Oregon.)

skins to slip off easily in peeling. They are chilled after heating to facilitate handling in peeling.

**18. Chilling.** The blanched vegetables must be placed in the can with all expediency. To make them cool enough to handle, they should be plunged into cold water after blanching. Chilling in this way also sets the color in green vegetables and tends to make most vegetables more crisp.

**19. Brine and Acidified Brines.** Vegetables, with the exception of tomatoes, are canned in dilute brine. Tomatoes are canned without any liquid except their own juice.

The usual brine contains from two to three ounces of salt per gallon. For practical purposes, an ounce is equivalent to a level tablespoonful of salt; this rule will save trouble in making up small quantities of brine.

Most vegetables are deficient in acid and if canned in a salt brine only are very difficult to sterilize. That is to say, the spores of the bacteria occurring on vegetables are very difficult to kill under this condition. If, however, the deficiency in acidity of the vegetables is made up by the addition of a small amount of some harmless acid substance such as lemon juice or vinegar, the vegetables are as easily sterilized as fruits. For example, in ordinary brine, asparagus must be sterilized for at least three hours in boiling water, while if a small amount (4 ounces or 8 tablespoonfuls per gallon) of lemon juice is added, this vegetable may be sterilized in one hour or less. Other vegetables behave similarly. Vinegar may be used to replace lemon juice, although slightly more is needed because ordinary vinegar is not quite so acid as lemon juice. The following table gives the amounts of salt and lemon juice or cider vinegar to use for various vegetables.

TABLE 4. AMOUNTS OF SALT AND LEMON JUICE OR STRONG VINEGAR FOR VEGETABLE CANNING BRINES

<i>Vegetables</i>	<i>Ounces Salt by Weight per Gallon of Water</i>	<i>Tablespoonfuls Salt per Quart</i>	<i>Ounces by Fluid Measure of Lemon Juice per Gallon</i>	<i>Tablespoonfuls Lemon Juice per Quart</i>	<i>Ounces Strong Vinegar by Fluid Measure per Gallon</i>	<i>Tablespoonfuls Strong Vinegar per Quart</i>
Carrots, asparagus, string beans, artichokes, turnips, parsnips, okra, cauliflower.....	3	1	5	2½	6	3
Peas and spinach.....	3	1	6	3	8	4
Corn.....	3	1	8	4	10	5

The advantage of this so-called "lemon juice" method is that the time of sterilization in water at 212° is greatly shortened and made much more certain. It is probably

the most satisfactory method for home canning. The amount used does not materially affect the flavor. The brine can be discarded when cans are opened and the vegetables cooked in fresh liquid or a small amount of baking soda may be added. This will remove practically all taste of the lemon juice or vinegar, should this flavor prove objectionable. Many vegetables are improved by the addition of the small amount of lemon juice or vinegar recommended.

**20. Addition of the Brine.** The brine should be added boiling hot to cans that are to be sealed, or the cans should be exhausted in steam or boiling water before sealing (see paragraph 14). Jars require a shorter time to heat if filled with hot brine. A teapot makes a very convenient utensil for heating and pouring brines or sirups into cans or jars. (See Fig. 10.)

**21. Sterilization.** Four ways of sterilizing vegetables are used. These are: (a) Sterilization under steam pressure; (b) intermittent sterilization in boiling water; (c) sterilization in boiling water by a single long sterilization; and (d) sterilization in boiling water by a relatively short heating after addition of a small amount of lemon juice or vinegar to the brine used in canning.

(a) Pressure Sterilization: The boiling point of water rises if steam is confined in a closed space, and temperatures much above 212° F. can be attained in this way. By this means the spores of many bacteria that are killed with the greatest difficulty at the temperature of boiling water are destroyed by a few minutes' heating under five to fifteen pounds' steam pressure. These pressures correspond to 228° F. and 250° F., respectively.

The following table shows the relation between steam pressure in pounds per square inch and temperature in degrees Fahrenheit. The table is of use where the sterilizer used may not be equipped both with a thermometer and a steam gauge.

The steam pressure sterilizer is independent of altitude and therefore is of value in elevated regions.

TABLE 5. RELATION BETWEEN STEAM PRESSURE IN POUNDS PER SQUARE INCH AND TEMPERATURE IN DEGREES FAHRENHEIT

<i>Pressure, Pounds per Square Inch</i>	<i>Temperature, Degrees Fahrenheit</i>
0.....	212.0
1.....	215.2
2.....	218.3
3.....	221.3
4.....	224.2
5.....	226.9
6.....	229.5
7.....	231.9
8.....	234.3
9.....	236.6
10.....	238.8
11.....	241.0
12.....	243.0
13.....	245.3
14.....	247.3
15.....	249.1

Several forms of steam pressure sterilizers for home use are on the market. There is one known as the "water seal outfit," which gives temperatures only slightly above the boiling point of water. This is considered favorably by many home canners; because it requires only a small amount of water, is easily heated, and is inexpensive. Another type can be operated only up to five pounds' pressure per square inch. Most forms of pressure cookers will withstand a steam pressure of 15 pounds or more per square inch.

Steam pressure sterilizers or retorts can be obtained in sizes holding from two dozen cans to several thousand. The small outfits are heated by direct heat; the large ones, by steam from a boiler.

Steam pressure sterilizers can be used for sterilization

at 212° F. by simply opening the release cock and keeping the pressure at 0 pounds.

Steam pressure sterilizers are well suited to sterilization of cans but are not convenient for jars.

In using the sterilizer, seal the cans of vegetables hot and place them in the basket or crate. Add water to the depth of several inches. Lower the crate and contents into the retort. Clamp the lid securely on the sterilizer and leave the release cock open. Heat the water to boiling and as soon as steam escapes freely from the cock close it. The purpose of leaving the cock open at first is to allow the steam to displace the air in the retort; otherwise the pressure in the retort would be due to compressed air and the temperature would be uneven and not in proportion to the indicated temperature or pressure. Heat until the dial of the steam gauge indicates the desired pressure or until the thermometer reaches the desired temperature for the required length of time by regulating the fire or by opening the release cock sufficiently, and by setting the weight on the safety valve so that it will release the steam automatically when the proper pressure is reached.

When the cans have been sterilized sufficiently, open the release cock and as soon as the pressure falls to zero, remove crate and contents and cool in a tub of cold water if cans have been used.

If jars are used, leave the lids and rubbers on loosely during sterilization. Close immediately after removal from the sterilizer, but do not, of course, chill the jars. (See Fig. 18.)

(b) Intermittent or Three-Day Sterilization of Vegetables at 212° F. is accomplished by heating the container and contents to the boiling point of water for a specified length of time on several (usually three), consecutive days. It is the most effective method at 212° F., because the bacterial spores start to grow between sterilizations

from the softening effect of the heat and are easily killed by the second and third sterilizations.

Cans are sealed hot and heated usually for one hour in boiling water or steam on each of three successive days. Jars are heated the first day with rubbers removed and caps on jars loosely. At the end of the first sterilization rubbers are sterilized in boiling water about five minutes, placed on the hot jars and the caps are screwed down. The second and third days the sterilizations are carried out without loosening the caps because the vacuum formed after the first day's sterilization will prevent bursting of the jars.

The three-day method is safe, but often softens the vegetables so much that they become unattractive in appearance.

(c) Sterilization of Vegetables at 212° F. by One-Period Method: By this method the vegetables are heated in boiling water or steam once only, but for a long period of time. The method is recommended strongly by the United States Department of Agriculture in Farmers' Bulletin 839 and is in extensive use.

No pressure sterilizer is used with this method. It sometimes results in softening of the vegetables from overcooking. Results of investigations by Dr. Dickson of Stanford indicate that this method does not always kill spores of certain bacteria. Method "(2)," described below, requires a shorter time of sterilization and therefore results in a more attractive product.

(d) Sterilization by the Lemon Juice Method: If a small amount of harmless vegetable acid in the form of lemon juice or vinegar is added, the brine vegetables are easily sterilized by a single sterilization at 212° F. The vegetables are best acidified by adding the lemon juice or vinegar to the brine used in filling the cans or jars. The amounts to use for various vegetables will be found in Table 4. The method is used as follows:

Pack the vegetables in the usual way. Add the hot brine which has been acidified. Seal the cans and put rubbers and caps loosely on the jars. Sterilize in boiling water or steam from three-quarters to two hours, depending upon the vegetable. Remove cans and chill in water. Remove jars and seal.

This method does not result in overcooking and retains the color and flavor more perfectly than other methods. It produces a slight acid taste in some vegetables. This can be removed before cooking for the table by drawing off the brine and cooking in fresh water in the usual way or by adding a small amount of baking soda before cooking for the table. The method has been proven safe and free from danger of *botulinus* poisoning.



## CHAPTER V

### CANNING OF MEATS

Meats are seldom canned in the household, because of the great difficulty of sterilizing them without a steam retort, and because of the fear of serious or fatal poisoning from the use of improperly sterilized meat. Sterilization can be safely accomplished without special equipment if care is used. Chicken, rabbit, salmon, trout, fresh pork, and other meats of which there, for some reason, may be a surplus, may be preserved in attractive form in this way.

**22. Preparation of Meats for Canning.** Meats are canned fresh or after curing or after a preliminary cooking.

Chicken and rabbit are usually first cooked and canned in the boneless condition or in pieces as the meat comes from the roasting oven or fry pan. The fresh meat may also be cut in pieces to fit the containers and sterilized without previous cooking. By the last process the meat is not usually so attractive as where it is first cooked in some way before canning. A suitable sauce or gravy should be added.

Beef is usually corned before canning (see Recipe 129) and canned with a gelatin broth which sets to a firm jelly when the meat is cooked after sterilization.

Fish is ordinarily canned fresh after cutting to fit the can. Various sauces or oil may be used to fill the cans, especially with small fish such as sardines. Tomato sauce is also used extensively. "Kippered" fish is also canned. This is fish soaked in brine and smoked a short

time. (See Recipe 139.) Salmon, tuna, shad roe, etc., are canned without added liquid.

**23. Sterilization of Meats.** Meats because of their low acidity, high protein content, and the presence of spore-bearing bacteria, are very difficult to sterilize. Pressure sterilizers or intermittent sterilization are very necessary in order that fatal poisoning from *botulinus* bacteria may not result. Mrs. Thomas of San Francisco, now with the Extension Division of the University of California, has made experiments in which she sterilized chicken in a brine acidified with about five ounces of lemon juice per gallon. She found that the meat was easily sterilized in boiling water. The method has not been tested sufficiently to warrant a recommendation for its general use. It seems very promising, however.

Meats should be sterilized under 10 to 15 pounds pressure for one heating or for 1½ hours in actively boiling water on each of three successive days. The one-period method at 212° F. is not recommended.

## CHAPTER VI

### STORAGE AND SPOILING OF CANNED FOODS

Canned foods should be stored under proper conditions in order that they shall keep to the best advantage.

A knowledge of the causes and results of the spoiling of canned goods is of great importance.

**24. Storage of Canned Foods.** If intended for market, canned fruits, vegetables, and meats should be stored a month or more to be certain that all goods marketed are in sound condition. A cool dark storage room is best for permanent storage, while a warm room is best if it is desired to ascertain whether the material will keep. Warm temperatures cause rapid growth of the microorganisms causing spoiling.

Fruits in jars will retain their color better if the jars are wrapped in paper to exclude the light.

The storeroom must be dry to prevent molding of jars and rusting of cans. Freezing and thawing injures the flavor and texture of canned goods; therefore, the storage room should be kept above the freezing point.

**25. Spoiling of Canned Foods—*Botulinus* Poisoning.** As stated in previous chapters, spoiling is due to the growth of microorganisms.

Fruits, because of their composition, are spoiled by molds or yeast. The spoiling of jars or cans of fruits usually means imperfect sealing and leaky containers, into which yeasts or molds gain access after sterilization. As the cans or jars cool after sterilization the contents contract, forming a vacuum, through which air with mold and yeast cells is drawn if the container has a small leak.

The products formed in a spoiled can or jar of fruit are alcohol and carbon dioxide from fermentation of the sugar. No poisonous compounds are formed. The carbon dioxide gas will cause the jar or can to burst if there is no other way for it to escape.

Vegetables are spoiled most commonly after sterilization by spore-bearing bacteria not killed during sterilization. Corn, peas, and asparagus are difficult to sterilize

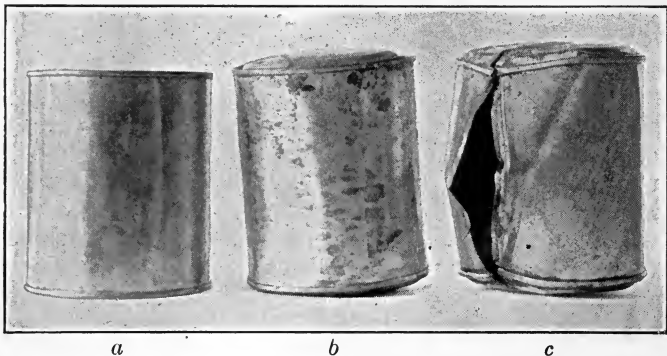

FIG. 19. Normal and Spoiled Cans of Food. *a*, Normal. *b*, Swelled can. *c*, Can burst by pressure of gas caused by fermentation. (After Zavalla.)

and often develop growths of various resistant bacteria. Vegetables are also spoiled by bacteria gaining entrance through leaks after sterilization. In these cases, the bacteria are usually of the lactic acid non-spore bearing type, in contrast to the non-acid forming spore bearers met with in imperfectly sterilized cans of vegetables.

Usually the products of decomposition in vegetables are harmless, although often vile in taste and odor. Occasionally, however, *botulinus* bacilli spores, will be present and survive the heating process. These develop and produce a very violent poison. Many fatal

cases have come to the notice of state boards of health, where death was caused by the use of imperfectly sterilized corn, peas, or string beans. The poison is so powerful that a single grain of corn from a can heavily infected with *botulinus* will cause death.

The presence of *botulinus* is hard to detect. Usually a rancid odor will be noticed and gas pressure normally develops, but the flavor may not be objectionable.

The poison is destroyed by heating the vegetables to boiling for half an hour after taking from the can. Most fatal cases have resulted where the vegetables have been used from the can or jar for salads, etc., without cooking thoroughly before serving.

Suspected vegetables should not be fed to chickens or animals without thorough boiling because the poison is fatal to animals as well as to human beings.

The cases of poisoning have occurred where vegetables have been canned by the hot-pack method without sterilization in the can. Where thorough sterilization by any one of the methods given in paragraph 21 is employed there is no danger from *botulinus*. Tomatoes do not develop *botulinus*. Other vegetables do.

Meats spoil in ways similar to those noted for vegetables and there is danger from *botulinus* poisoning unless the meats are thoroughly sterilized. Fish and other marine products are especially difficult to sterilize and therefore must be canned with great care. Dr. Dickson of Stanford has done a great deal of work on the occurrence of *botulinus* in food products, especially in canned vegetables.

## CHAPTER VII

### FRUIT JUICES

Refreshing juices of pleasing flavor can be made from many fruits. The problem is one of so preserving the juice that as much as possible of its fresh flavor and appearance is retained. The most practical way of accomplishing this is by pasteurization by heat at temperatures from 150° to 180° F.

**26. Fruits for Juice.** Fruits for juice making should possess an agreeable flavor and aroma and be rather tart in taste. Very sweet fruits of low acid do not make attractive juices. Grapes should possess an agreeable flavor and high acid. A red color is preferred to white. The Eastern varieties have these qualities in a single variety. Two Californian varieties must be blended; one furnishing flavor and the other color and acid. Muscat, blended with any tart red wine grape, will give the desired result. Concord, Isabella, or other good Eastern varieties, used alone, give good results. The grapes should not be too sweet. A juice of 20% sugar and .8% to 1% acid is of the proper composition.

Loganberries make an excellent juice. They should be as ripe as possible.

Blackberries, raspberries, and strawberries make rather poor juices.

Apple juice is used in great quantities fresh, but a relatively small amount is pasteurized, largely because apples may be obtained practically throughout the whole year for the production of fresh juice.

Orange and lemon juices have not been successes com-

mercially, because of the difficulty in retaining the flavor of the fresh juices.

Pomelo or grape fruit juice has been developed commercially in Florida.

Pineapple juice as now found on the market is attractive in appearance, but very disappointing in flavor.

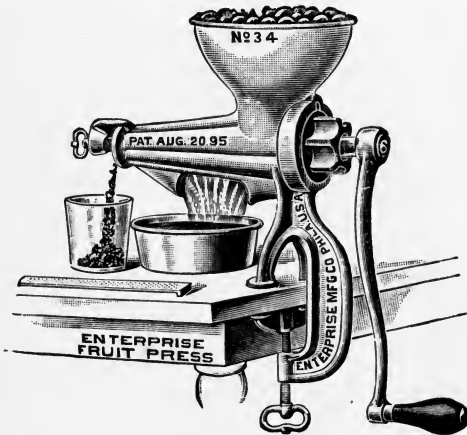

FIG. 20. Small Crusher for Home Use. (Courtesy of Berger and Carter Company, San Francisco, California.)

Pomegranates produce a highly colored juice of fair flavor, but there is considerable difficulty in separating the juice-bearing seeds from the astringent pulp.

Grape, apple, loganberry, and pomelo juices are all easily prepared and are all of very satisfactory quality. Other fruits may prove satisfactory sources of juice as methods of preparing the juice are developed by investigation.

**27. Crushing.** To facilitate heating of the fruit before pressing and the extraction of the juice the fruit must be thoroughly crushed.

In the household a small food chopper or small fruit crusher may be used. (See Fig. 20.) Small hand power crushers are available for farm use. (See Fig. 22.) Larger crushers for factory use are of many types, sizes, and



FIG. 21. Pressing Crushed Fruit.

prices. Grape crushers consist of two wooden or iron cylinders revolving closely together to crush the fruit but not the seeds. It is desirable to separate the stems from grapes after crushing. This is done by mechanical stemmers or by hand by use of a coarse screen.

**28. Heating before Pressing.** The color of grapes must be dissolved from the skins by heating. Berries will press more satisfactorily if heated. Citrus fruits, pomegranates, and apples should not be heated.

The crushed grapes should be heated to about 120° to 135°

F. by use of an aluminum or agateware pot. They should be stirred frequently and the temperature observed carefully with a dairy or other type of thermometer, that can be conveniently immersed in the crushed grapes. Grapes are allowed to stand twenty-



four hours before pressing to permit the color to dissolve in the juice. The grapes may also be heated by separating the juice by pressing and heating it to 140 to 150° F. and returning it to the skins.

Berries should be heated to about 150 to 165° F. and pressed hot.

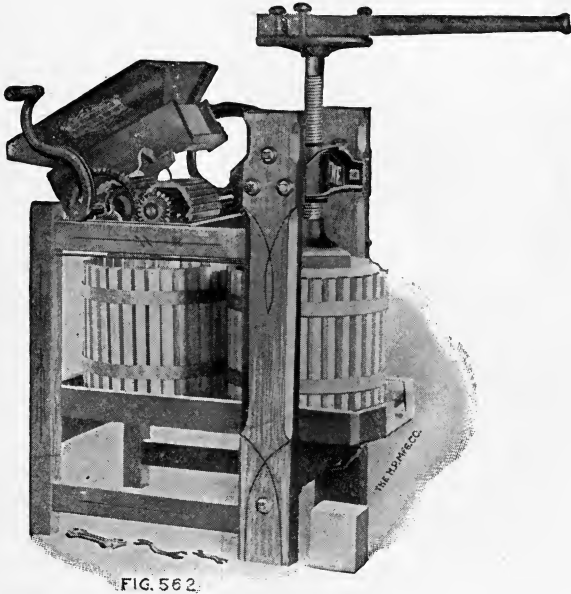

FIG. 22. Small Crusher and Press for Farm Use. (Courtesy of Berger and Carter Company, San Francisco, California.)

**29. Pressing.** The simplest press is a heavy cloth bag which may be twisted. Small kitchen presses may be had also. Various sizes and forms of presses suitable for farm and factory use may be had. The hydraulic press is the most commonly used commercial press and gives the highest pressure of any fruit press.

Pressure is applied directly to the fruit in the "basket" form of press. In the rack and cloth type the fruit is held between layers of heavy press cloths. Wooden

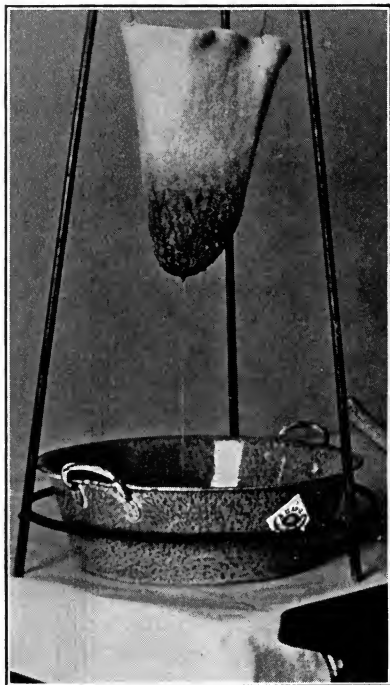

FIG. 23. Straining juice after pressing. Same arrangement may be used for separating juice from crushed soft fruits.

racks separate the cloths. This type of press gives a clearer juice than the basket press but requires more labor.

**30. Clearing the Juice.** The juice comes from the press cloudy—not perfectly clear. It also contains proteins in solution which, if not removed, are coagulated during pasteurization later and cause the juice to become cloudy. Therefore, to produce a juice which will be clear and remain so in the bottle, it must be heated to the temperature at which the juice is to be pasteurized later and must then be filtered or otherwise cleared. The juice will then clear more

satisfactorily if it is allowed to stand overnight after pressing and before clarifying. After standing this length of time it may be drawn off from the sediment and cleared in any way desired.

The juice may be clarified by the addition of egg white, casein, or Spanish clay before heating. These materials are coagulated and settle out after heating, carrying down with them the suspended particles which have caused the juice to be cloudy. Grape juice may be clarified by any of the above materials used singly; or with casein or egg white employed in combination with the clay. Other juices are best clarified by the use of the clay only. Casein may be bought from a drug store or chemical supply house. Spanish clay may be obtained from chemical supply firms.

The casein is prepared for use by boiling together three ounces of casein to one ounce of sal soda in one quart of water. When dissolved, this is diluted to one gallon with water. Spanish clay is prepared for use by soaking a weighed amount in a measured amount of water until soft. One gallon of water is used for each pound of clay. When soft it is worked into a thin, even-grained mud with the water. Egg white is mixed with several times its volume of water and stirred until dissolved. Dried albumen may also be used.

In using the clarifying materials described above, the amount necessary is measured and added to the juice and mixed thoroughly by stirring.

The juice is then heated to 175° F. and allowed to stand twenty-four hours. Most of the juice can then be poured off clear from the sediment or filtered easily through a jelly bag.

It must be emphasized that clarification is not necessary for the preservation of the juice, and results in some loss of flavor. It is not generally recommended for home use. It is only necessary in the home production of juice to heat it to 175° F. allow it to cool twenty-four hours, and filter through a jelly bag.

The juice may be filtered through a felt filter bag specially made for small scale filtration or through an

ordinary cloth bag. Filter bags vary in size from one to ten gallons and cost from one and one-half to ten dollars. Larger metal filters that are filled with asbestos or wood fiber are used in large scale filtration, but cost very much more.

A box filled with sand also makes a fairly satisfactory filter. A funnel fitted with filter paper can also be used.

Filters must be thoroughly washed after use to prevent souring. Juice is ordinarily difficult to filter, unless clarified, and the filters must be changed and cleaned often during continued filtration to maintain them at full capacity.

For home use a rough filtration without a clarification is all that is required.

**31. Bottling and Canning.** The previous operations have prepared the juice for the final container in which it is to be stored. Bottles, jars, and cans are all used as containers. These should be clean.

Two types of bottles are available: those with plain tops to be closed with corks and those with special tops to be closed with caps or crowns. The bottles should not be filled completely and a space of about an inch and a half should be left between the cork and the juice.

If the bottles are to be corked, the corks must be sterilized in boiling water for ten minutes before they are used. Ordinary taper corks of good quality may be used, but wine bottle corks driven into the bottles with an inexpensive apparatus designed for the work give better results.

The corks must be tied down with a string to hold them in place during pasteurization.

If crown finish bottles such as soda water, beer, or grape juice bottles are used, the crowns or caps are crimped on by a special machine. This costs from five dollars upward. The crowns cost about thirty cents per gross and are cheaper and more attractive in ap-

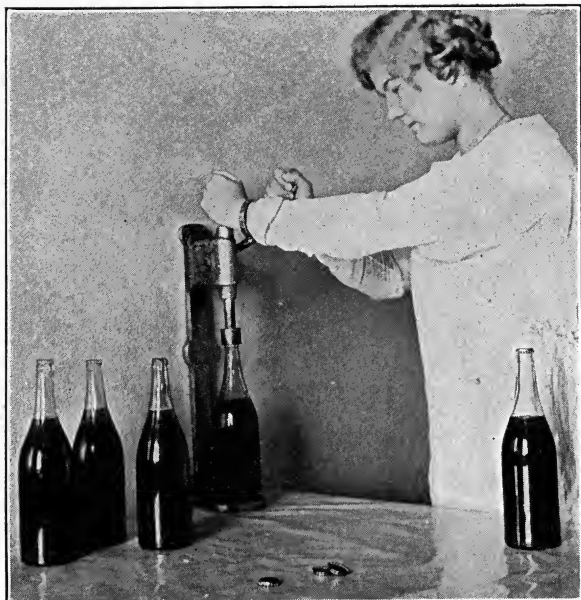

FIG. 24. Capping Bottles with Small Hand Power Crown Capper. Note that bottles are not completely full.

pearance than corks. If any great amount of juice is to be put up, their use is recommended.

Cans may be used for the less acid juices, such as grape and apple juices, but are not recommended for very acid berry or lemon juice, because of the danger of the solution of tin in poisonous quantities. Enamel lined cans are best and sanitary cans are to be preferred to solder top cans because of the danger from the action of the juice on the solder used in sealing the latter.

Cans may be filled with hot juice at 180° F. and sealed at once without further sterilization. A better plan is to fill them with warm (not hot) juice, seal, and then pasteurize.



FIG. 25. Sterilizing Bottles of Juice. Note that bottles lie horizontally and are completely immersed in the water.

Jars may also be used. They are filled with the warm juice and sealed at once with scalded caps and rubbers. The juices are pasteurized in the jars.

**32. Pasteurization of Fruit Juices.** Fruit juices must not be overheated but nevertheless they must be heated to a high enough temperature to insure their keeping. This temperature is between  $165^{\circ}$  and  $170^{\circ}$  F. The temperature must be maintained for about twenty minutes. Juice should never be boiled.

The most convenient and certain way of obtaining these conditions is to heat the bottles or cans while they are completely immersed in water.

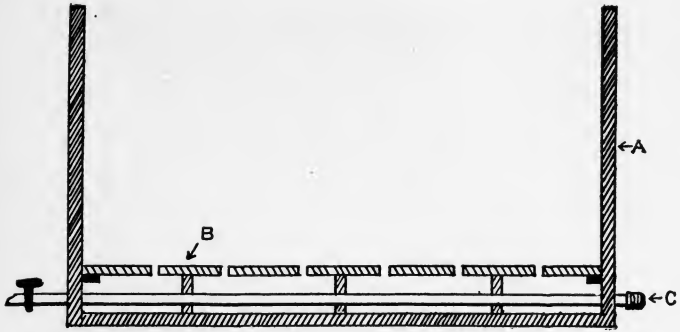

FIG. 26. Wooden Vat with Steam Coil for Use in Sterilizing Bottles of Juice or Cans of Food. A. Walls (of wood). B. False Bottom. C. Steam Coil.

An ordinary wash boiler with a false bottom makes a satisfactory pasteurizer; or any of the factory-made home and farm sterilizers may be filled with water and used as pasteurizers.

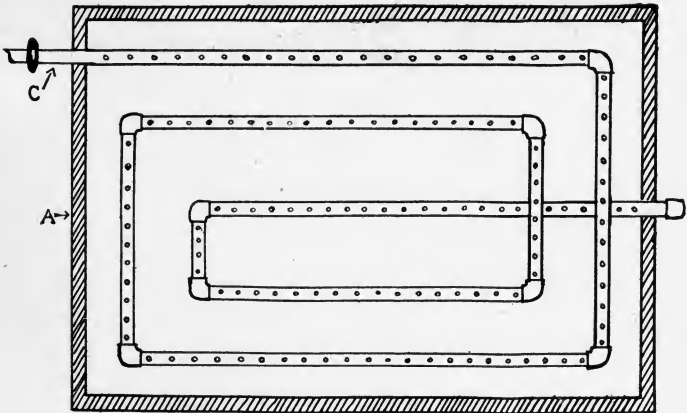

FIG. 27. Plan for Arrangement of Steam Coil of Fig. 26. Showing perforations for escape of steam for direct heating of water.



FIG. 28. Dipping Ends of Bottles in Melted Paraffin to Seal Corks after Pasteurizing. This is not necessary if crown caps are used.

See Fig. 25. A larger pasteurizer may be made of a wooden tank and steam coils as indicated in Figs. 26 and 27.

The sealed jars, bottles, or cans, are placed in the pasteurizer and completely covered with water. Bottles should lie horizontally so that the hot juice will sterilize the corks. With a thermometer inserted in the water, it is heated to 175° F. and maintained at this temperature for twenty minutes. The temperature in the containers



will be several degrees below 175° F. The bottles or cans are then removed. The necks of corked bottles should be dipped in paraffin or sealing wax as soon as removed and again when cool. Bottles closed with crown caps need not be so treated.

## CHAPTER VIII

### FRUIT AND OTHER SIRUPS

Many fruits and other substances may be used as sources of sugary liquids which may be evaporated to sirups suitable for cooking and table use. In most cases the ordinary kitchen utensils will be all that is required in the way of equipment.

**33. Sources of Sirups.** Maple, sugar, beet, cane, and sweet sorghum saps; grape, apple, peach, prune and some other fruit juices can all be used as sources of table and cooking sirups. They can be prepared with ordinary kitchen equipment. Such sirups will be more or less dark colored and will not be equal in flavor to the best grades of commercially prepared table sirup, but still very palatable sirups can be produced in the home.

**34. Clearing the Juice.** The juices should be expressed as for fruit juices. The juice should be made as clear as possible before concentration by heating to boiling for a short time with clarifying agents as described in paragraph 30 or by filtration after boiling. The clearer the juice is before concentration the more attractive will the sirup be. The juice will filter more rapidly hot than cold.

**35. Deacidification.** Some juices are improved for table use by removing a portion of the acidity before concentration. This is especially true of grape, sorghum, and apple juices. Precipitated chalk will combine with and remove fruit acids. It may be obtained at any drug store.

The acidity must not be completely neutralized or the sirup will be very dark colored and of poor flavor. Partial deacidification is best accomplished as follows:

The cleared juice is divided into two portions, one equivalent to three-fourths and the other one-quarter of the total. To each gallon of the larger portion is added an ounce of the chalk. It is heated with constant stirring to boiling. It is then removed from the fire and allowed to stand twenty-four hours. The clear juice is poured off from the sediment and filtered. The sediment may be filtered to recover the juice contained in it.

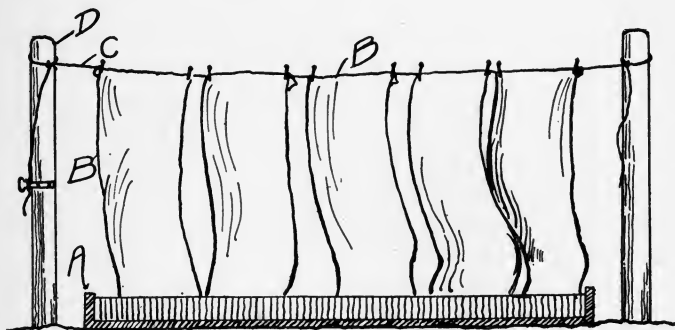

FIG. 29. Apparatus for Sun Evaporation of Fruit Juices. A. Shallow trough or pan to hold juice. B. Pieces of cheesecloth for evaporation of juice. C. Line to hold cloths. D. Posts for support of line.

To the treated juice is added the untreated portion. This will give a combined juice of one-fourth the acidity of the original fresh juice.

Juices of very low acid need not be treated with chalk.

**36. Concentration.** The sirup must be boiled down until it will test  $70^{\circ}$  Brix or Balling or  $37^{\circ}$  Baumé in order that it will contain enough sugar to prevent spoiling. The concentration should be carried out as rapidly as possible in shallow vessels to minimize scorching the sirup and darkening the color.

Large factories carry out the concentrating process

under a vacuum, which causes the juice to boil at a lower temperature than 212° F. This prevents darkening of the color and scorching. Vacuum evaporators are too expensive for small scale operations and the housewife or farmer must use open pans or kettles.

The shallower the pan, the more rapid the evaporation will be and the less the injury to flavor and color. A large rectangular tin lined pan built in over a brick furnace can be used for larger scale work. These pans are usually so arranged by partitions that the juice may be added at the upper end of the pan and sirup will flow from the lower end, the excess water being boiled off as the juice flows from the upper to the lower end.

During evaporation, samples of the sirup should be taken and transferred to a tall jar and tested with a hydrometer. A tall olive bottle or tall narrow can will answer for a hydrometer jar. The hydrometer may be purchased from any chemical supply house for about fifty to seventy-five cents or through a drug store. The druggist will usually order one on request. The Brix or Balling hydrometers ordered should read from 0 to 70° and the Baumé from 0 to 50°. A glass cylinder for the hydrometer, if desired, can be obtained for about fifty cents. If the purchase of a tester is not deemed worth while the sirup is simply boiled down to a very thick consistency. It may also be boiled down only partially and sealed in jars or bottles boiling hot. If this is done the sirup will keep with less than 65% sugar.

**Sun Evaporation:** Sirup may also be made by evaporation in the sun by the Waterhouse method. The clear juice is placed in a broad shallow pan or in a shallow wooden trough. Above this is hung a number of lines from which hang pieces of cheese cloth. The whole apparatus is placed in the open. The cheese cloth is dipped in the juice and hung on the lines. The air and sun quickly dry the juice on the cloth to a sirup. The

cloths are then dipped in the juice and the sirup wrung out into the juice. They are again wet with the juice and hung up to dry. The process is repeated until the consistency of a heavy sirup is reached. This process was developed by Addison G. Waterhouse, and was patented by him a number of years ago. He devised a number of methods by which the cheesecloth was made in the form of a long endless belt which revolved slowly. It passed through the juice at one end of the circuit and through rollers at the other end which squeezed out the evaporated juice.

The method is easy of application and inexpensive. (See Fig. 29.)

**37. Storing the Sirup.** If concentrated so that the juice will test 70° Balling or Brix or 37° Baumé when cold, the sirup may be stored in any sort of tin, glass, or wooden container without sterilization. If less concentrated than this, it should be poured boiling hot into scalded jars, bottles, or cans, and sealed hot. It will then keep indefinitely.

## CHAPTER IX

### JELLIES AND MARMALADES

The production of both jellies and marmalades depends on the same principles, and the methods of manufacture are similar. For these reasons they have been discussed together in this chapter.

The following paragraphs give the fundamental principles as well as a discussion of various tests for jelly.



FIG. 30. The Pectin Test. To test suitability of fruit juices for jelly making.

These enable anyone at all familiar with cooking to obtain uniform results.

**38. Fruits for Jelly.** A fruit jelly depends for its consistency upon three substances. These are pectin and acid, from the fruit, and sugar, which is added. If any one of the three components is lacking or too small in amount, jelly cannot be made.

Certain fruits are rich in both pectin and acid. Examples are sour apples, crab apples, currants, loganberries, and lemons. Jelly is easily made from these fruits. Some fruits contain moderate amounts of pectin and acid. Examples are loquats, oranges, ripe apples, blackberries, grape fruit, and some varieties of plums. Jellies can be made from these fruits if care is taken. Some fruits are rich in pectin but low in acid. The guava, quince, and fejoia are examples. Acid fruits must be added to such fruits. Other fruits are low in pectin but rich in acid; for example, rhubarb and gooseberries. Still other fruits are deficient in both acid and pectin. Peaches, apricots, prunes, pears, strawberries, and raspberries belong to this class. They must be combined with such fruits rich in pectin as currants, crab apples, or sour apples, before jelly can be made from them.

TABLE 6. SUITABILITY OF VARIOUS FRUITS FOR JELLY

<i>Fruits Rich in Pectin and Acid. Jelly can be Easily Made from Them</i>	<i>Fruits with Medium Amounts of Pectin and Acid. Will make Jelly if Carefully Used</i>	<i>Fruits Rich in Pectin but Low in Acid. Acid Fruit must be Added</i>	<i>Fruits Low in Pectin and Acid. Fruit from Column 1 must be Added</i>
Sour apples Crab apples Currants Loganberries Lemons Cranberries Sour plums Eastern varieties of grapes	Ripe apples Blackberries Oranges Grape fruit Loquat Most plums California grapes Sour cherries Quinces	Guava Fejoia Unripe Figs Pie Melon	Apricots Peaches Pears Strawberries Raspberries

**39. Preparing and Cooking the Fruit.** The fruits are prepared for cooking by cutting in pieces or by crushing. Berries and currants should be crushed. Other fruits are cut.

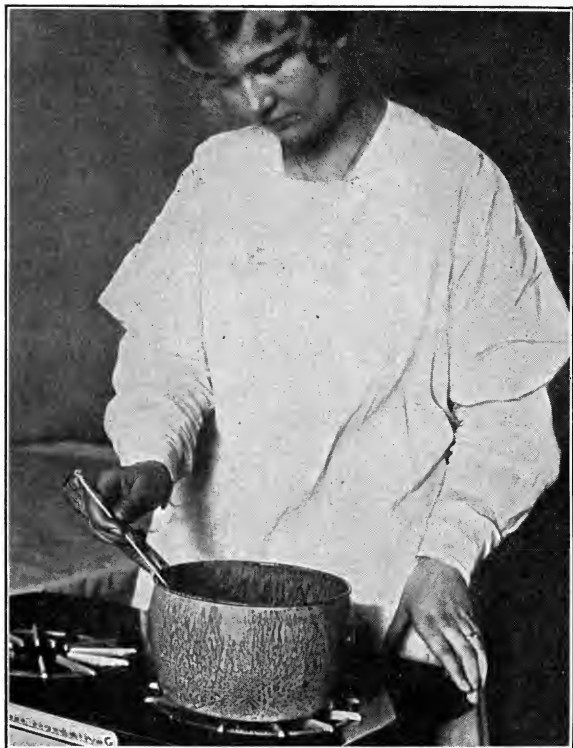

FIG. 31. The Thermometer Test for Jellies. To determine when jelly has cooked sufficiently. Boil to 218 to 221° F., depending on consistency desired.

The pectin is held in the tissues of the fruit and in most cases must be liberated by boiling. Jellies can be made from currants, loganberries, and cranberries by using the juice obtained by crushing and pressing the fresh fruit without cooking, but even these soft fruits give firmer jellies if boiled before extracting the juice.



In cooking the fruit, water must be added to the less juicy varieties, such as apples, plums, etc. Only enough should be added to barely cover the fruit; if too much is added the juice will be too dilute and failure will result. Currants, grapes, and berries need no added water.

The fruits should be cooked only until tender. For apples this will be ten to fifteen minutes' boiling. Berries should only be heated to boiling. Oranges, lemons, and grape fruit are tough and require about an hour's boiling. Long boiling of any fruit results in loss of flavor.

**40. Expressing and Clearing the Juice.** The hot juice may be pressed from the fruit or may be allowed to simply drain from the fruit through a cloth. The latter method is usually employed in the household. In factories the juice is pressed from the hot fruit with heavy pressure. If the juice is merely allowed to drain from the fruit through a jelly bag it will be clearer than if obtained by pressure, but pressing will give a larger yield of juice and the juice will contain more pectin. Both methods may be combined by allowing most of the juice to drain from the fruit through a jelly bag, followed by pressing out the juice from the residual pulp in a small press or by twisting the jelly bag to exert pressure. Juice obtained by pressure must be filtered through a bag several times to clear it. If this is done, very clear bright jelly can be made from it.

All fruit juices for jelly making should be made as clear as possible by straining or filtering.

**41. Testing for Pectin.** If any doubt as to the jelling properties of the juice exists, it should be tested for pectin. Failure can often be averted by this test.

Obtain a small amount (a ten cent bottle) of grain alcohol from the druggist. To one teaspoonful of the juice in a glass add one teaspoonful of the alcohol and stir slowly. If the juice is rich in pectin, a very large amount of bulky gelatinous material will form in the

glass, almost turning the material to a soft jelly. Juices moderately rich in pectin will give a few large pieces of gelatinous material and juices too poor in pectin to make jelly will give a few small flaky pieces of sediment.

If the juice proves poor in pectin it must be blended with a juice rich in pectin. See paragraph 43 for the amount of sugar to add to the juices of various pectin content. The less pectin the fruit contains the less sugar can be used.

**42. Testing for Acid.** Fruits rich enough in pectin to give a good jelly may not possess enough acid. No accurate simple household method can be given, although the following test will aid in judging of the acidity of the juice.

To one teaspoonful of lemon juice add nine teaspoonfuls of water, and one-half teaspoonful of sugar. Mix in a glass. Place in another glass a little of the fruit juice, but add no water to it.

Compare the tartness of the two liquids by taste. If the fruit juice is not as sour as the diluted lemon juice it is deficient in acid and it will be necessary to raise the acidity of the fruit juice by adding lemon or other sour juice.

With a little practice and experience this test can be made very useful, although it is, of course, not very accurate.

**43. Addition of Sugar.** The amount of sugar to add to the juice will vary with the pectin and acid content of the fruit. Juices such as loganberry, currant, crab apple, and sour apples, that are rich in acid and pectin, will make good jellies if one cup or as much as one and one-quarter cups of sugar are used to each cup of juice. In some cases as much as one and one-half cups of sugar can be used.

With fruit juices only moderately rich in pectin, but still of fair jelling quality, three-fourths of a cup of sugar

may be used and with fruits low in pectin, only one-half a cup of sugar may be used.

The reason for using less sugar with fruits poorer in pectin is seen from the following discussion. To make jelly, the juice must finally contain a high amount of sugar (55 to 65%), and enough pectin and acid to form a jelly with the sugar. Boiling the juice after adding the sugar concentrates the pectin by boiling off the excess water. The boiling must continue until the jelly contains 55% or over of sugar. The more sugar is added the less boiling is necessary and for the same reason the less concentrating of the pectin in the juice takes place. If a small amount of sugar is added, more boiling down is necessary to produce the requisite high concentration of sugar and this results in greater boiling down and concentrating of the pectin. Thus, if to a cupful of juice poor in pectin only a half cupful of sugar is added the juice must be boiled down to a relatively small volume and this will so increase the pectin in proportion to the sugar that a jelly will usually result.

The sugar may be added cold as there is no special virtue in warming it.

**44. Sheeting Test for Jelling Point.** The juice and sugar should be boiled down rapidly in shallow pots. Long boiling, such as is necessary in large amounts in deep pots, results in loss of flavor, darkening of color, and caramelization of the sugar.

The juice must be boiled down until it will jell when cold. This will be between 55 and 65% or more sugar, depending upon the pectin content of the fruit. The usual way of testing this point is to allow the jelly to drip from a large spoon. If it falls from the spoon in wide sheets it is considered done. It is also usually done when the boiling jelly forms large bubbles and apparently "tries to jump out of the pot."

**45. Thermometer Test.** A more accurate test is the

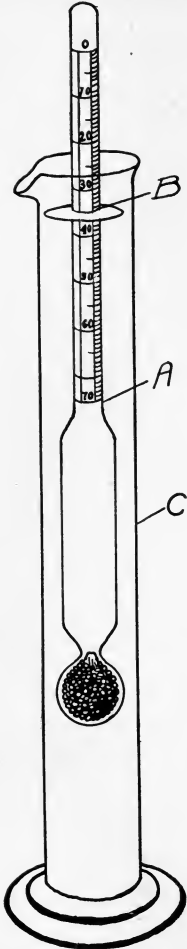

FIG. 32. Baumé Hydrometer for Jelly Test. Boil to 29 to 31° Baumé, depending on consistency desired. A. Hydrometer. B. Level of liquid at which hydrometer is read. C. Cylinder to hold liquid.

thermometer test. A candy or other good thermometer is kept in the boiling liquid. As the juice boils down the boiling temperature increases. When it reaches 221° F. or 105° C., it has reached the proper point for a stiff jelly. The thermometer must be kept well immersed in the boiling juice for this test. (See Fig. 30.)

When the boiling point reaches 221° F., it merely indicates that the jelly contains 65% sugar. This will mean a stiff jelly that will stand shipping, assuming that the fruit juice contains sufficient pectin and acid. If a less firm jelly is desired, it should be boiled only to 219 or 218° F. Often for household use such a jelly is more desirable than a very stiff jelly. It must be remembered that these figures apply only to fruits with a sufficient amount of pectin and acid.

**46. Hydrometer Test for Jelling Point.** The various types of hydrometers described under "Sirups for Canning" (see paragraph 11) may be used to test the jelling point. Their use is not so convenient as that of the thermometer. They are more certain and satisfactory than the sheeting test.

While the jelly is boiling hot,

pour it into a tall glass or tin or copper cylinder. A tall narrow twenty-five cent flower vase, or a tall narrow olive jar, or even a quart milk bottle will answer for a cylinder. Insert the hydrometer and read the degree at the surface of the liquid. When the test reads 32° Baumé or 62° Brix or Balling in the hot juice, a stiff jelly will result if the juice contains sufficient pectin. Similarly, a "quivery" or less firm jelly will result at 29° Baumé or 58° Balling or Brix, assuming that the fruit contains sufficient pectin and acid.

#### **47. Meaning of Thermometer and Hydrometer Tests.**

These tests simply indicate that the jelly contains a certain amount of sugar and that boiling has concentrated the juice down to this sugar content. It does not necessarily mean that one will always obtain a jelly by boiling the juice down to the temperatures or Baumé and Balling degrees mentioned above. If the fruit is deficient in pectin and acid or in only one of these constituents, jelly cannot be made, regardless of the amount of boiling taking place.

On the other hand, if sufficient pectin and acid are present, the above tests are very valuable in determining the jelling point.

**48. Pouring and Cooling the Jelly.** Pour the jelly into glasses or other containers. Paper jelly containers are now on the market which answer the purpose very well. The glasses should be dry.

If the jelly is poured through a piece of cheesecloth or tea strainer into the glasses, any coarse particles will be removed.

Allow the jelly to cool overnight before sealing with paraffin.

**49. Coating with Paraffin.** When the jelly has set, paraffin should be added to seal it. If paraffin is added to the hot jelly the jelly "sweats" or moistens the sides of the glass between the paraffin and the glass. This

causes the paraffin to become loose so that it no longer protects the jelly. The hot jelly also decreases or contracts in volume as it cools—the paraffin sets before contraction ceases and is apt to not fit down closely on the jelly later.

If when the jelly is cold, the inside of the glass above the jelly is wiped perfectly dry with a cloth or if the jelly is allowed to stand until this part of the glass is absolutely dry, the paraffin will adhere perfectly when added.

Add the paraffin hot enough to sterilize the top of the jelly. This will insure its keeping.

**50. Sterilization of Jellies.** If jellies contain less than 65% sugar, *i. e.*, the jelly tests less than 32° Baumé or 62° Balling or Brix when hot, or boils at less than 221° F., it may ferment or mold unless sterilized in sealed glasses or jars. In the hot interior valleys of California housewives lose a great many glasses of jelly by fermentation. Under such conditions the jelly should be boiled down to the point noted above or should be placed in jars and sterilized. This can be done by pouring the hot jelly into scalded jars and sealing at once. The glasses are then immersed in water at the simmering point for fifteen minutes to sterilize the rubbers and caps. Such jelly will keep under all conditions of weather.

**51. Jellies without Cooking.** A few fruits are so rich in pectin and acid that jellies can be made from them without heating the fruit or the juice and sugar. Such fruits are currants, loganberries, and cranberries.

Crush the fruit thoroughly and press out the juice with vigorous pressure to force the pectin out of the pulp. Strain as clearly as possible.

Two methods may then be used. By the first method, add one and one-half cups of sugar to each cup of juice and mix thoroughly until the sugar dissolves. Pour into glasses and place the glasses in the sun for several days until the jelly becomes firm. The sun evaporates the

excess moisture. Bright sunlight is necessary. When jelly has formed, seal with paraffin.

Jelly may also be made without sun evaporation if two cups of sugar are added to each cup of juice.

**52. Jelly Stocks.** The juice obtained by draining or pressing the hot fruit after cooking may be sterilized in bottles as directed for fruit juices (see paragraph 32) or poured boiling hot into jars or cans and sealed without cooking. This juice or "jelly stock" can be used by the usual method at any time by adding sugar and boiling down to the jelling point. This economizes on jelly glasses and results in fresher flavored jellies.

**53. Crystallization of Jellies.** Crystals form in grape jelly from the separation of cream of tartar. There is no certain way of preventing this. It can be greatly minimized, however, if the juice is boiled down about one-half after pressing and is then stored in bottles or jars for about six months before being made into jelly.

Crystallization in other jellies is caused by the presence of excess sugar. This may be caused by the sugar added in making the jelly or may be caused by crystals of glucose, a sugar found in all fruits. It can be prevented if the jelly is boiled down so that it contains not more than 70% sugar. The use of the thermometer and hydrometer tests will guard against this common defect in jellies.

**54. Marmalades.** Marmalades differ from jellies only in the fact that they have pieces of the fruit suspended in the jelly. Fruits for marmalade must be rich in pectin and acid.

The principles of marmalade making are the same as for jelly making. First, a portion of the fruit is boiled, pressed, and strained to give a pectin solution. Part of the fruit is cut in thin slices, cooked till tender, and added to the juice obtained by boiling and pressing. Sugar in equal volume is added and the mixture boiled down to the jelling point.

Orange marmalade is the best known. Dundee marmalade is the standard. It is made in Scotland from the bitter Seville orange shipped from Spain in brine. It possesses the peculiar aromatic and bitter flavor of this orange.

In the United States the usual commercial varieties of oranges, such as the Naval, Valencia, Mediterranean Sweet, Satsuma, etc., are used in combination with lemons. Lemons furnish the acid and oranges the pectin.

Grape fruit is also used a great deal for marmalade, both alone and in combination with lemons.

Fruits rich in pectin, such as apples, currants, and loganberries may be used as source

of the pectin solution and shreds of apricots, peach, watermelon rind, pear, quince, etc., may be added to produce the marmalade effect.



FIG. 33. Marmalade Slicer. Can also be used for vegetables. (Courtesy of Henninger and Ayes Company, Portland, Oregon.)



## CHAPTER X

### FRUIT JAMS, BUTTERS, AND PASTES

These products resemble each other in appearance and method of manufacture and are therefore considered together. Soft fruit not suitable for canning can often be made into the above products. Apple butter and other fruit butters are often made without the use of sugar, thus affording a way of using certain fruits without the addition of this otherwise very important item in the cost of fruit preserving.

**55. Jams.** Jams are made by cooking and crushing the whole fruit, adding sugar, and boiling a short time. They are usually not heavily spiced and are not cooked for any great length of time. The fruit is not broken up very finely. Apricots and berries and other fruits of high flavor and soft texture are suitable. If a large amount of sugar is used, *i. e.*, enough so that the jam will contain over 65% sugar after it is cooked, it will keep without sterilization. It is usually necessary, however, to either pack the jam boiling hot into containers, and seal or to sterilize in the containers because the amount of sugar ordinarily employed is not sufficient to preserve the product indefinitely.

**56. Fruit Butters.** Fruit butters differ from fruit jams chiefly in that they are boiled longer than jams, are finer grained, and smoother in texture, and are usually heavily spiced. It is also customary to add the boiled down juice or sirup of the fruit to the crushed fruit to replace a certain amount of sugar that must otherwise be used. Many recipes call for the use of fruit, fruit sirup, and spices only, no sugar being added.

The fruit juice, usually equal in bulk to the fruit to be used, is boiled down to a light sirup and the fruit is then cooked down to a thick consistency in the sirup with or without the addition of sugar. Apple juice and grape juice may be used with many varieties of fruits, and a considerable saving in sugar can be so effected.

**57. Fruit Pastes.** Fruit butters or jams may be cooked down slowly to as thick a consistency as possible without scorching. They may then be allowed to evaporate slowly on the back of the stove or in shallow dishes in the sun to a thick paste. This will keep without sterilization.

The pulp from jelly making may be ground up finely and cooked with an equal quantity of sugar to give an attractive fruit paste. A sort of confection can be made by spreading this on a platter or shallow dish in the sun and drying down to a gelatinous firm consistency. It can then be cut into cubes to be used as candy or as a garnishing for desserts.

## CHAPTER XI

### FRUIT PRESERVES AND CANDIED FRUITS

Preserves and candied products both owe their flavor, appearance, and keeping qualities to the large amount of sugar used in their preparation. Preserves are put up in a heavy sirup while candied products contain more sugar than do preserves and are packed dry. Both are expensive because of the sugar necessary and the care and time required in their preparation.

**58. Preserves.** Preserves are fruits or vegetables containing so much sugar in the form of a heavy sirup that they are in the nature of a confection. Because of their exceedingly high sugar content, sterilization is not usually necessary. Fruits for preserves should retain their shape well during cooking. Pears, quinces, many varieties of peaches, figs, kumquats, pineapple, and watermelon rinds are all good for preserves. For most fruits it is desirable to start cooking the fruit in a dilute sirup of about 30% sugar, or one cup of sugar to about two or three of water. If too heavy a sirup is used at first the fruit is apt to be tough, regardless of the amount of cooking given. A dilute sirup penetrates the fruit. When the fruit has become tender enough in the light sirup the sirup is concentrated by boiling down to 65% sugar or 221° F. as for jellies. The hydrometer test may be used to test the sirup.

Strawberries are often used for preserves, but must be handled with care. In this case sugar equal in weight to the berries used is added. They are cooked only a short time and left to stand in the sirup until they will absorb the sirup and become plump. Commercial fac-

tories add artificial color in the form of Ponceau 3R and Amaranth to give the proper tint to the berries, because the natural strawberry color soon fades.

Preserves are packed hot into jars or glasses and sealed with ordinary jar caps or with hot paraffin.

Soft fruits can be used for preserves if cooked only a short time in a heavy sirup and then left in shallow dishes in the sun to permit concentration of the sugar by solar evaporation. This method is especially good for strawberry preserves.

**59. Candied Fruits.** Candied fruits are confections made by impregnating fruit with a very heavy sirup, followed by draining and partial drying so that the fruit may be handled easily. They should be glossy or "glacéd" in appearance, semitransparent, of the shape and size of the original fruit; the flesh should be free from sugar crystals and the surface should not be sticky.

The process is one of covering the partially cooked fruit with a dilute hot sirup which from day to day is gradually increased in sugar content until it becomes a very heavy sirup, which impregnates the fruit with a high sugar content, 65 to 70%. The slow increase in sugar is necessary to avoid shrivelling and toughening of the fruit. In order that the shape and appearance of the fruit may be retained, long boiling as in making preserves is objectionable. Whole fruits, such as cherries, apricots, figs, etc., are punctured thoroughly, through and through, in numerous places with coarse wooden or copper needles to permit penetration of the sirup. Large pears and peaches are peeled and cut in half. Pineapple slices from the canned product are excellent for candying purposes.

The fruit is then cooked until tender in a dilute sirup made up of glucose or corn sirup. Karo Korn sirup is good for the purpose. Use one cup of this sirup or of glucose to three cups of water.

The fruit and sirup are allowed to stand twenty-four hours in this sirup in a pot or stoneware crock. A wooden float will keep them immersed. On the next day, the sirup is poured off and increased to 30% sugar or 15% Baumé or about a half a cup of sugar is added to each six cups of sirup. The sirup is heated to boiling and poured back over the fruit. After twenty-four hours it



FIG. 34. Placing Candied Fruits on Wire Screen to Drain.

is increased to 35% sugar, or another half a cup of sugar is added to each six cups of sirup and the sirup again poured boiling hot over the fruit. This is repeated with a 5% Balling or 3% Baumé or half a cup sugar to 6 cups of sirup, increase each day until a sirup of 68% Balling or 36° Baumé is reached, or until the sirup is about as thick as honey.

The fruit is then drained on a screen a few days and when dry enough to no longer be sticky can be packed in candy or other pasteboard boxes.

A moderate amount of glucose in the product prevents

hardening of the fruit and the formation of crystals of sugar in the fruit. It also gives a glossy appearance and causes the fruit to remain semitransparent. Glucose used alone produces a flat tasting product; hence the desirability of using cane or beet sugar with it as directed above.

## CHAPTER XII

### FRUIT DRYING

Dried fruit is one of the most concentrated of all fruit products and one of the simplest to prepare. It requires no very expensive or special equipment when carried out on a small scale.

Fruit is dried in two ways: (a) by sun evaporation, and (b) by artificial heat. The former is used in dry hot climates such as prevail in California and Arizona, while the latter must often be used in climates where summer rains occur. Both methods are discussed in the following pages.

**60. Importance of the Industry.** Fruit is dried on a very extensive scale in California, and in this state fruit drying is one of the largest horticultural industries. It serves in this state both as a primary industry and as an insurance against low prices for fruit grown primarily for canning or fresh shipment. As in other states, a certain amount of cull fruit is dried, but as a rule, the fruit used is the average orchard run. The raisin industry in California amounts to 125,000 tons of raisins annually, and is the largest of the state's dried fruit outputs. Prunes, figs, peaches, pears, and apricots are also dried in large quantities. The climate of this state is dry and hot without summer rains. This permits drying in the sun and accounts for the size of the industry.

In other fruit growing regions of the United States artificial heat is used almost exclusively in drying. Drying fruit is one of the cheapest and most convenient ways of saving surplus fruit crops. If well done the

quality of the product compares favorably with that of canned fruit.

**61. Gathering the Fruit.** Drying does not improve or disguise the quality of the fruit. To obtain dried fruit of good marketability, a good grade of fresh fruit must be used.



FIG. 35. Knocking Ripe Prunes from Trees for Drying.

The stage of ripeness at which the fruit is picked varies with the variety. Apricots are picked firm ripe—if too ripe they will melt down to unattractive “slabs”; figs and prunes are allowed to ripen until they drop from the trees of their own accord; peaches are gathered when fully ripe, but while still firm enough to permit handling; pears are picked when full

size, but not yet ripe, and are allowed to ripen in piles of straw before drying; grapes are picked when fully ripe; apples for drying are usually the packing house culls. The riper the fruit is, the more sugar it will contain and therefore the larger the yield of dry fruit will be, unless the fruit is overripe and so soft that excessive loss occurs.

**62. Transfer to the Dry Yard.** The fruit should be taken quickly to the dry yard or evaporator after picking and so handled that bruising does not take place.



Fruit for drying should be handled as carefully as fruit for fresh shipment, if the best results are expected.

**63. Cutting and Peeling.** Apples are peeled, cored, and cut into disks before drying. Other fruits are usually dried without peeling.

Peaches and apricots are cut in half and pitted by hand. Pears are cut in half lengthwise before placing on drying trays. They are not peeled or cored. Peaches are sometimes peeled before drying by use of a hot concentrated lye solution. The peaches are cut and pitted; then immersed in a boiling 10% soda lye solution for a long enough time to soften the skin thoroughly. They are then passed through strong jets of water that wash off the softened skins and remove the lye adhering to the pit cavities. This method of peeling is not easily used on a small scale and is only recommended for large dry yards.

**64. Dipping Fruits before Drying.** Prunes are dipped in a hot dilute lye solution a few seconds to crack the skins before they are dried. The dipping solution contains about  $\frac{1}{2}\%$  of lye or one pound per thirty gallons of water, for the French prune, the one most commonly grown. The solution is more dilute for the Sugar Prune and Imperial Prune, two less important varieties. The prunes are held in a wire basket in which they are immersed in the hot lye solution for five to thirty seconds, or they are carried through the liquid in a perforated rotating drum. They are often dipped in water or are passed through water sprays to remove excess lye and adhering dirt. The dipping checks the skins sufficiently to greatly increase the rate of drying.

Sultanina and Sultana seedless grapes are often dipped in hot dilute ( $\frac{1}{2}\%$ ) lye solution or in sodium bicarbonate solution to crack the skin slightly or to remove the bloom to facilitate drying. The dipping in dilute lye is also carried out in connection with the sulphuring of Sultanina



FIG. 36. Dipping Prunes and White Grapes in Boiling  $\frac{1}{2}\%$  Lye Solution before Drying.

grapes (Thompson Seedless). It increases the rate of absorption of the sulphur fumes. Grapes after dipping in hot lye are rinsed in cold water while those dipped in cold sodium bicarbonate solution are not rinsed in water but are placed directly upon trays to dry.

**65. Sulphuring Fruits before Drying.** Fruits darken badly, unless treated with fumes of burning sulphur before drying. The darkening is due to oxidation of the coloring matter. Sulphur fumes prevent oxidation and darkening. In some cases, for example in Muscat raisins and prunes, the dark color is considered desirable; in others the dark color is objectionable. Apricots, pears, apples,

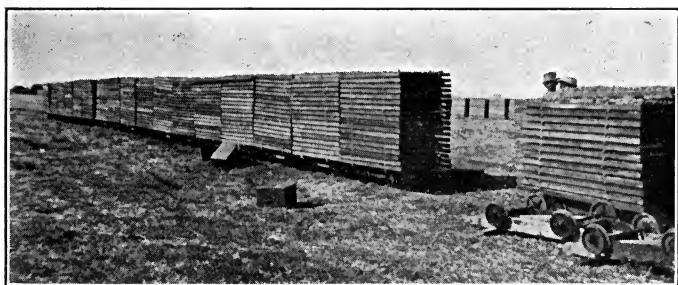
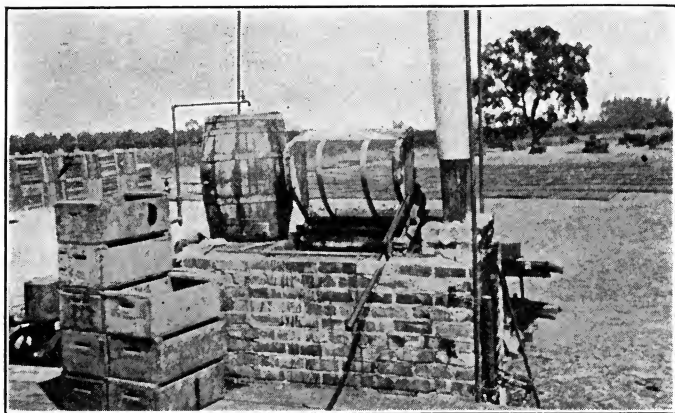

FIG. 37. Upper View, Fruit Dipper for Prunes. Lower View, Stacking Fruit that is nearly Dry. This permits drying to finish in the shade, giving a more uniform product.

and peaches are usually "sulphured" before drying. Sulphuring should not be excessive, because the flavor of the fruit is thereby injured and sulphuring should never be employed to cover up defects.

In addition to preventing the darkening of the color, the sulphur fumes act as mild a preservative and tend to prevent the molding and fermentation of the fruit during sun drying.

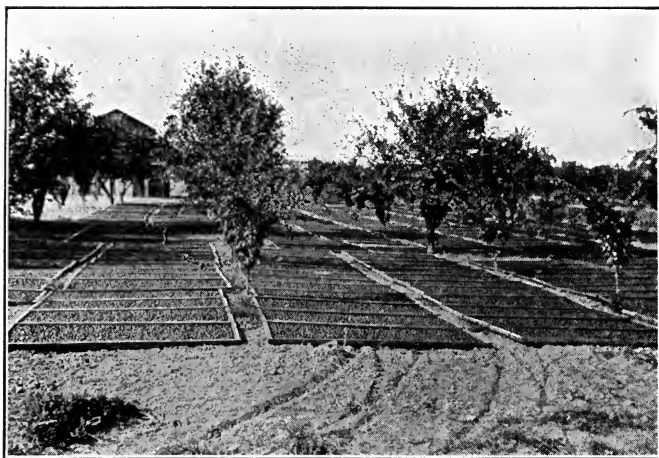

FIG. 38. Views of Drying Yards in California. In lower figure is shown a portion of a field of 20 acres of fruit trays.

A great deal of controversy has arisen in the past and a great diversity of opinion exists at present as to the effect of sulphurous acid in food products (sulphurous acid and sulphur dioxide are other names for the fumes of burning sulphur). It is generally admitted that when large amounts of sulphurous acid are eaten in food, injury to health results; but it is extremely doubtful whether the relatively small amount eaten in cooked dried sulphured fruits is harmful. Cooking drives off a great deal of the sulphurous acid and little remains in the cooked fruit, unless the fruit has been badly over sulphured.

The sulphuring of the fruit is accomplished by spreading it on drying trays and exposing the fruit and trays to the fumes of burning sulphur for the desired length of time. The room or box in which the sulphuring is carried out is commonly called a "sulphur box" or "sulphur house." It may be a small house large enough to hold a small hand truck or carload of trays, or may be so constructed that the trays may rest on cleats on the sides of the sulphur box. A very convenient form is the so-called "balloon sulphur hood." This is a light rectangular wooden or building paper covered box that can be set down over a stack of about one dozen trays.

Sulphur is burned in a shallow pit inside the sulphur box in the ground beneath the trays, or in a container outside the box and the fumes are conducted into the box by means of a flue. To ignite the sulphur, a small amount of excelsior or a few shavings may be used. The sulphur should be kept burning constantly for the length of time it is desired to expose the fruit to the fumes.

Apples are sometimes sulphured by passing them on a belt conveyor through a long box filled with sulphur fumes. Sliced apples are sulphured for twenty to thirty minutes; apricots, peaches, and seedless grapes, three to five hours, and pears, six to forty-eight hours. After sulphuring, the fruit is ready for the dry yard or evaporator.

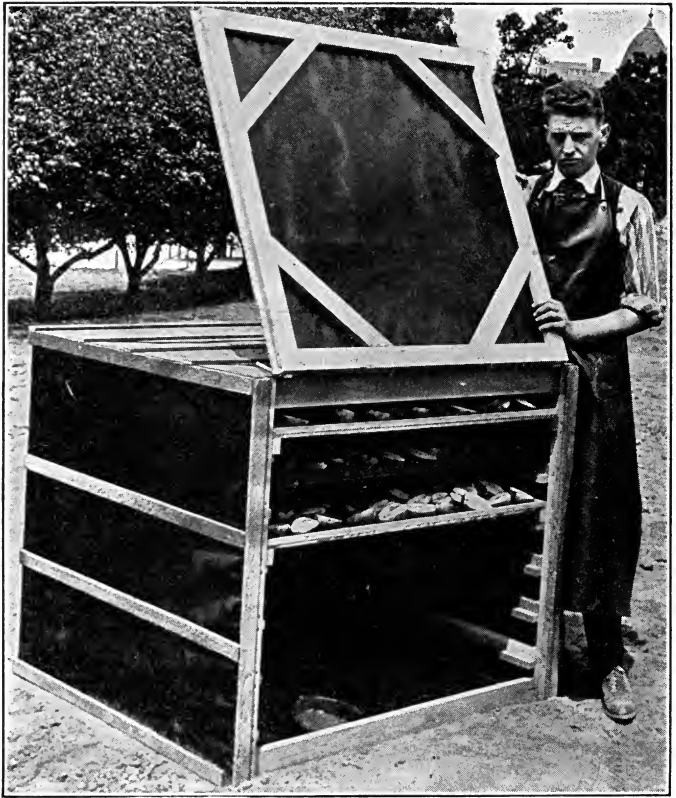

FIG. 39. Small Fruit Sulphuring Box for Home Use. Note pears cut in half for drying.

**66. Trays for Sun Drying.** Wooden trays 2 x 3 feet, or 3 x 6 feet, or 3 x 8 feet are used in sun drying fruits commercially. These are made of sugar pine or other tasteless white wood. Redwood colors the fruit. Shakes 3" x 6" are nailed to side strips and cleats are nailed to

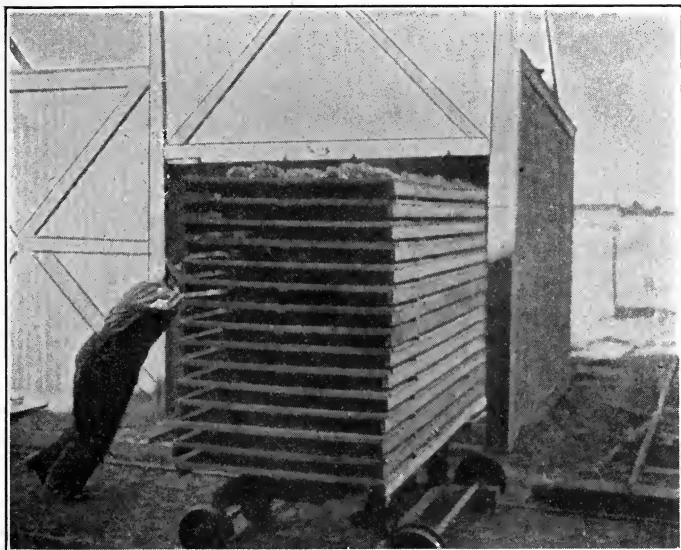

FIG. 40. Sulphuring Fruit on a Large Scale in California. The trays of fruit on car in picture have just been sulphured in the sulphur house in the background.

the ends. In long trays, one or two narrow strips of wood are nailed lengthwise near the center of the tray to act as a support.

For drying small amounts of fruit, improvised trays may be used. Cloth or paper will answer the purpose or the fruit may be placed directly on a flat roof.

**67. Sun Drying.** A dry hot climate, free from rains, is necessary for sun drying. Sun drying requires less

equipment and labor than drying by artificial heat. There is more tendency for darkening of the fruit, for accumulation of dust, and injury by insects or mold than is the case in artificial drying. However, dried fruits of excellent quality are made by this method.



FIG. 41. Muscat Grapes Drying on Trays in the Vineyard. Note that trays are tilted toward sun and that the grapes are stacked on the trays in shallow layers.

The fruit after preparation by cutting, dipping, peeling, spreading on trays, and sulphuring, as the case may require, is then exposed to the sun on trays that are placed on the ground. The drying yard should be clean and as free from dust as possible.

Grapes are turned when about one-half dry by inverting a full tray over an empty one. Prunes are stirred or turned several times during drying to cause even drying. Other fruits are ordinarily not turned.

In case of a shower, the trays are stacked in piles of a



dozen or more trays each and covered with empty trays or with boards to shed the rain. Late in the season this often becomes necessary. During long rain storms or continued cloudy weather, it is sometimes necessary to use artificial heat, or the partially dried fruit must be



FIG. 42. Sorting Dried Prunes. The partially dried fruit and culls are sorted out.

heavily sulphured to prevent molding until there is again sufficient sunshine to permit drying.

The fruit should not be allowed to become too dry. The texture of the finished product should be leathery, not hard and brittle. Excessive drying results in great loss of flavor and makes the fruit difficult to cook.

The fruit will dry more uniformly, the color will be better, and there will be less danger of its becoming too dry, if the trays are stacked when the fruit is about two-thirds dry. They should be stacked so that the air will pass freely between them and complete the drying.

All of the fruit will not dry at the same rate, and when most of it is sufficiently dry, it is taken from the trays. That which is not dried sufficiently is left on the trays a few days longer.

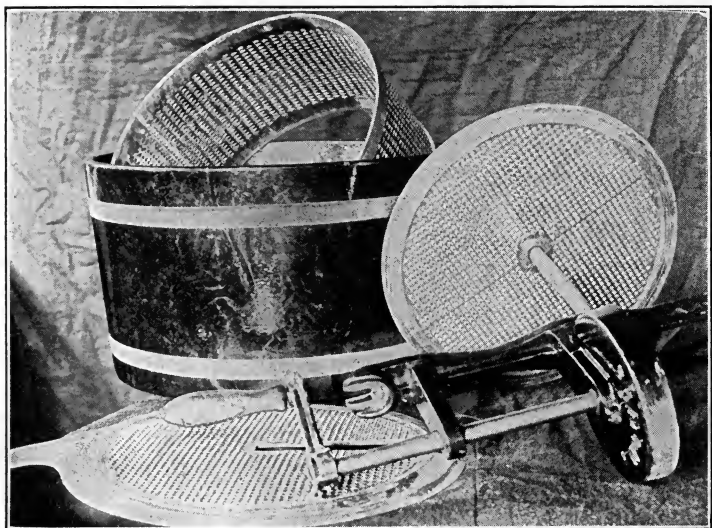

FIG. 43. Pomona Vegetable Peeler. This machine is very useful in peeling vegetables for drying.

In good drying weather most fruits are left four to six days in the sun, and about the same length of time in the stack, making a total time of eight to twelve days.

**68. Artificial Evaporation.** The rate of removal of water by evaporation by sun or artificial heat depends upon three factors: (1) temperature, (2) humidity of the air, and (3) the rate at which the air passes over the fruit. In many fruit growing sections, factors "1" and "2," or both, are not favorable for sun drying, and artificial heat must be used.

Evaporators are of many sizes and designs. An efficient dryer should take into account all three of the above principles. The temperature in the evaporator may be raised to about  $115^{\circ}$  F. for most fresh fruits and

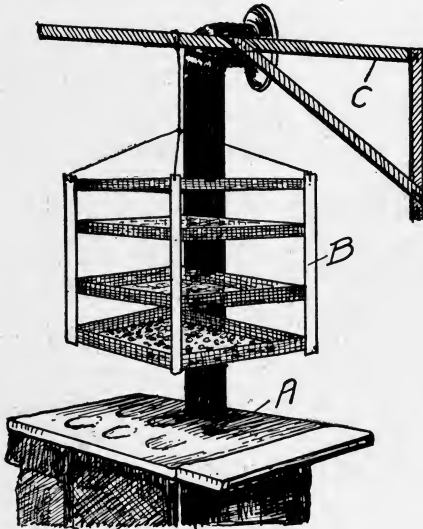

FIG. 44. A Home Made Dryer for Use above the Kitchen Stove. A. Stove. B. Frame with screen trays. C. Support. (After Farmers' Bulletin 841, United States Department of Agriculture.)

$140^{\circ}$  F. for fruit that is almost dry. Temperatures much above this cause scorching and severe darkening of color. Thermometers should be used to record the temperature in the dryer.

The humidity or moisture content of the air passing through the dryer is exceedingly important. If air is saturated with water vapor it will not cause drying, regardless of the amount used; therefore, the evaporator

cannot be made so long that the air passing through becomes oversaturated with moisture. A rise in temperature greatly increases the power of the air to absorb moisture. Thus air at ordinary temperatures may be saturated with water vapor, but when heated to  $140^{\circ}$  to



FIG. 45. Small Home Made Cabinet Dryer. Can be used on kitchen stove.

$175^{\circ}$  F., will again be able to take up a very large amount of moisture. It must not, however, be allowed to cool before it leaves the dryer, or the cooling will cause the excess moisture to condense on the fruit at the upper end of the dryer. If, therefore, the air is well heated, it will be "dry" before it goes into the dryer regardless of its previous moisture content when cold.

The importance of the volume of the air passing over the fruit is a point often lost sight of in building dryers. Air soon becomes saturated with moisture. If it is not

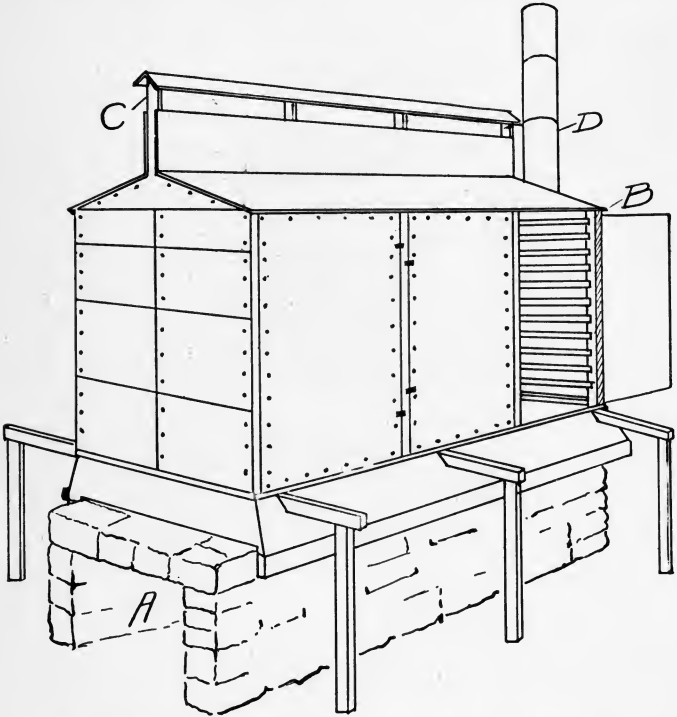

FIG. 46. Galvanized Iron Fruit and Vegetable Dryer for Farm Use. (After J. S. Caldwell, Extension Bulletin 27, Series I, State College of Washington.)

replaced with fresh air at once, the saturated air passes over the remaining fruit without causing drying. If the air is supplied more rapidly than it becomes saturated with water, drying proceeds throughout the whole dryer. The

rate of absorption of water vapor is greatest when the warm air first enters the evaporator and before it has absorbed very much moisture. Therefore, if the volume of air passed through is very large, the rate of absorption is greatly increased, because the air is constantly in the condition in which it most rapidly takes up water.

With these principles in mind, the artificial dryer should be built so that an even temperature, dry air, and a large supply of air are maintained.

A simple dryer for home use can be constructed from a few pieces of galvanized coarse mesh screen. This is hung or placed on metal supports above the stove. The dryer consists of several of these screen trays placed one above the other at about three-inch intervals. (See Fig. 44.)

A small cabinet dryer can be made of rough lumber, an old stove, and a few lengths of stove pipe. (See Fig. 45.)

For larger scale drying, several types of evaporators are in use. The kiln dryer is one of the cheapest. A floor, usually 20 x 20 feet, made up of wooden strips with spaces between for passage of hot air, forms the drying surface on which the fruit is placed. Beneath the floor the flue or stove pipe from the heater is placed. This is led back and forth across the dryer several times to distribute the heat under the entire floor. A roof with a large ventilator completes the dryer.

The tunnel dryer consists usually of a wooden chamber 12 to 18 feet long and 6 x 3 feet in cross section. It is sloping. Hot air flues pass beneath it. The trays slide in on runways at the upper end and are taken out at the lower end. The entering tray displaces one at the lower end. This dryer is used a great deal for berries and prunes in the Pacific Northwest.

The cabinet evaporator consists of an upright heating chamber into which the trays fit one above the other.

Heat is supplied at the bottom from hot flues or from steam pipes. The fresh fruit is placed at the top. As a new tray goes in, a tray of dried fruit is taken from the bottom of the stack, the whole stack of trays automatically dropping the height of one tray. This form of dryer is used in some apple drying sections.

The air blast evaporator is one of the most satisfactory types. It is used for grapes and prunes during rainy weather in the central portion of California. It consists of a long narrow room the width of an eight-foot tray. At one end is a large air fan. Back of the fan is a series of very hot flues. The trays are stacked on trucks and run into the long chamber through side doors. The fan draws the hot air over the flues and forces it through the drying chamber over the fruit. The rate of drying is rapid and the maximum efficiency of the heat is obtained because of the large volume of air used.

Specific directions for temperatures of drying, etc., for various fruits will be found in recipes in Part III.

**69. Sweating.** Fruit dries unevenly, some pieces being hard and dry and others not quite dry enough when the bulk of the fruit has reached the desired stage of dryness. The moisture content of the outer layers of the fruit is less than that of the center of each piece. The moisture content is equalized by storing the fruit in bins or large boxes for a time to undergo "sweating," which is nothing more nor less than equalization of the moisture. The sweat boxes or bin must be protected from insects and should be kept dry and cool. The fruit is left in the sweat boxes about two weeks, or until packed for final storage or market.

**70. Processing and Packing.** Fruit dried in the sun usually becomes infested with insects or insect eggs which would later produce larvae with resulting loss of the fruit. Often the fruit may become too dry or may be dusty.

Treatment of the fruit with boiling hot water for a short time will overcome the above defects. This may be accomplished by placing the fruit in a wire basket and immersing it in boiling water for about one minute. If it has been very dry it may be packed at once; if only medium dry it may be necessary to allow it to dry on trays a short time before packing.

Apricots, peaches, and pears are sometimes sulphured for one to three hours after dipping in hot water. This is often done to permit the fruit to absorb large amounts of water without fermenting or molding—the sulphurous acid acting as an antiseptic. Its use is not to be encouraged in treating dried fruits for this purpose.

The packing of dried fruits is an extensive industry, requiring rather elaborate and expensive machinery and a variety of processes, which cannot be described or discussed adequately in this volume.

Raisins are dried to an almost anhydrous state at the packing house; are then stemmed in a special machine; processed in hot water; and the raisins with seeds are seeded in a complicated seeding machine.

Prunes are graded for size according to number per pound. The seller is paid on a basis of eighty prunes to the pound. He is penalized for all prunes requiring more than eighty to the pound and is paid a premium for those requiring less than eighty to the pound. After grading they are processed in hot water and packed.

Dried fruit for market is usually packed in paraffin paper lined wooden boxes of 20 to 50 pounds' capacity, or in paper cartons of half pound to one pound size. Packed fruit brings much better prices than bulk dried fruit. Attractive packages are essential for successful marketing.

Dried fruit for home use should be stored in insect-proof containers, away from rodents. Paper bags, tight



boxes, jars, etc., can be used. Ordinary cloth or burlap bags are not suitable, because it is possible for insects to deposit eggs through these.

A dry place should be selected so that the fruit will not become moldy.

## CHAPTER XIII

### DRYING VEGETABLES

Many surplus vegetables can be dried and thus made available for use throughout the year. The methods are similar to those used for fruits. In regions of dry summers, sun drying may be used; under other conditions, artificial evaporation must be resorted to.

Vegetables contain from 80% to 95% water; drying, therefore, decreases the weight from five to twenty-fold.

**71. Vegetables for Drying.** Certain vegetables give very good products when dried; others do not lend themselves well to this method of preservation or are more satisfactory when preserved in some other way, *e. g.*, by salting or fermentation, etc. Corn, green peas, green string beans, potatoes, turnips, carrots, onions, and tomatoes may be dried very satisfactorily. Artichokes, asparagus, cucumbers, cabbage, sweet peppers, and cauliflower do not dry well, and give better results when preserved by salting or fermentation.

**72. Preparation.** The vegetables should be clean and of good quality. Root vegetables should be washed thoroughly.

Potatoes must be peeled. Vegetable peelers are available for this purpose, for the peeling of all root vegetables. These machines vary from small kitchen sizes to large power driven peelers of several tons' daily capacity. Turnips, carrots, parsnips, and onions are best peeled without parboiling. Beets are parboiled for fifteen or twenty minutes, after which the skin may be slipped off easily.

Other vegetables are prepared as for cooking for the table.

**73. Blanching.** Certain vegetables, such as potatoes, corn, and beets, are improved if heated in boiling water a short time before drying. Carrots, turnips, onions, and vegetables of green color, such as peas and string beans, need not be blanched because it results in loss of color in these cases.

Blanching is useful in preventing the darkening of Irish potatoes where sulphuring is not used. Potatoes contain a substance called oxidase which causes darkening when the cut surfaces of the potato are exposed to the air. This oxidase is destroyed by heating the potatoes through in boiling water. Vegetables that have been blanched before drying are more tender than those not so treated and can be cooked in a shorter time.

**74. Sulphuring.** Potatoes turn black in color unless parboiled or sulphured before drying. The most attractive dried potatoes are made by sulphuring the sliced vegetable for twenty minutes before drying. Any of the forms of fruit sulphuring devices previously described may be used. Turnips, tomatoes, carrots, and onions are improved by sulphuring. Other vegetables should never be sulphured because of the bleaching action. Tomatoes should be sulphured about two hours. Potatoes, carrots, onions, and turnips for twenty minutes. The sulphuring is carried out after the vegetables have been sliced and placed on trays.

**75. Sun Drying.** The prepared vegetables may be dried on trays in the sun as described for fruits. Vegetables, with the exception of tomatoes, dry very quickly. They should be allowed to become nearly "bone" dry, not merely leathery in texture. Any sort of tray may be used, such as those previously described for fruits. (See paragraph 66.)

When the vegetables are nearly dry, the trays should

be stacked so that drying will proceed more uniformly and so that less darkening of color will take place.

Peas, string beans, and other vegetables with much chlorophyll should be dried in the shade. This can be done by exposing the vegetables to the sun on trays a short time and then allowing the vegetables to dry after



FIG. 47. Packing of Dried Vegetables in Insect-Proof Containers. Sun dried vegetables should be heated to 150° F. in an oven or dipped in boiling water and dried again before packing, to kill insect eggs.

the trays are stacked. This gives a brighter green color than that obtained where the vegetables are dried completely in the sun.

**76. Artificial Drying.** Any of the driers described for fruits under paragraph 68 may be used for vegetables. In large commercial dryers continuous systems are largely in use. The prepared vegetables pass on endless metal cloth conveyors or by screw conveyors through a drying chamber through which is circulated a strong counter current of hot air. The vegetables are handled largely by automatic machinery in order to cut down

labor costs. The dried product is pressed into bales or boxes after drying to economize on shipping space.

Artificial evaporators are necessary in many vegetable growing localities because of fogs and rain. In general, higher grade dried vegetable products can be made by artificial, than by sun evaporation.

Apple dryers and hop kilns can be used for vegetable drying when not in use for the purpose for which they were built. Temperatures of drying and approximate lengths of time required are given in the vegetable drying recipes in Part III.

**77. Processing Sun Dried Vegetables.** Sun dried vegetables must be sterilized by steaming a short time or plunging in boiling water for about half a minute or by heating through in an oven to destroy insect eggs. The excess moisture can then be dried out before packing.

Artificially dried vegetables do not require sterilization if they are packed soon after drying.

**78. Packing and Storing Dried Vegetables.** Vegetables should be packed in insect-proof containers and stored in a dry place secure from rodents. Ordinary cloth or burlap sacks are not insect-proof; but if the dried vegetables are first wrapped in paper or placed in paper bags they may then be safely stored in sacks. It is a good plan to hang the sacks of vegetables from a rafter so that mice or rats will not reach them.

Dried vegetables may be pressed into cubes or bales. This economizes on space and checks insect injury.

## CHAPTER XIV

### VINEGAR MANUFACTURE

Waste fruits, inferior honey, and other sugar containing materials not suitable for sale or use otherwise can often be made into satisfactory vinegar. The waste cores and peels from canneries and fruit driers can be turned to profit in this way. Vinegar is used in enormous quantities for ketchup and pickles in addition to the large amounts used as table vinegar.

Vinegar making is a fairly simple process, provided the fundamental principles involved are well understood.

**79. General Principles.** Vinegar making depends on two fermentation processes. The first is a transformation of sugar into alcohol, and carbonic acid gas by yeast. The second is the conversion of the alcohol into acetic ("vinegar") acid. The second fermentation cannot take place before the first and must follow the first. If it should start before the yeast fermentation is complete, it will stop the yeast fermentation and give an inferior vinegar. Vinegar manufacture depends on making these two fermentations as efficient as possible, and in keeping them separate. In the following paragraphs the methods of controlling the two fermentations are discussed.

**80. Raw Materials.** Any substance containing 10% or more sugar, or a substance easily changed to sugar, or any fermented liquid containing 4% or more alcohol can be made into vinegar in the household. Industrially starch and distilled alcohol are also used. Fruit juices, dried fruits, fruit sirups, partially fermented jelly, honey, and spoiled wine can all be used. Watermelons do not contain enough sugar.

**81. Crushing Fruits for Vinegar.** Fruits used for vinegar should be thoroughly crushed in a food chopper or fruit crusher. The crushed fruit should be placed in a crock or wooden barrel, for yeast fermentation, before pressing. Grapes and berries in small lots are easily

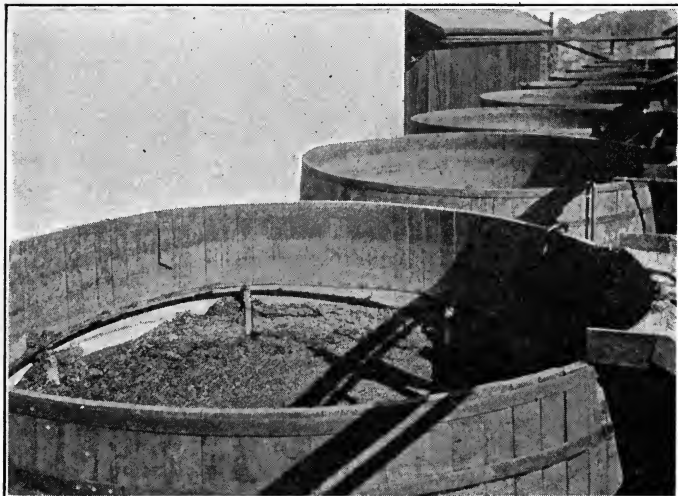

FIG. 48. Fermenting Vats Used in Large Scale Manufacture of Vinegar from Fruits.

crushed by the hands. Very ripe peaches, pears, apricots, and plums, are easily crushed with the hands or with a potato masher. Apples require the use of a crusher or grinder. Yeast should be added to the crushed fruit. See paragraph 84 on addition of yeast.

**82. Diluting Honey.** To each cup of honey add four cups of water and one-half a cup of any fruit juice. Honey does not ordinarily contain enough yeast food to cause a good fermentation. The fruit juice furnishes this necessary food. Yeast must be added as directed in paragraph 84.

**83. Preparation of Fruit Cores and Peels and Dried Fruits for Vinegar Making.** Cores and peels, give good results if two cups of water is added to each cup of fruit, the mixture boiled until the fruit is tender, pressed and sweetened with one half a cup of sugar to each four cups of juice. Dried fruits contain about 60% of sugar. They may be used for vinegar making if four pints of water is added to each pound of fruit. The mixture is allowed to soak twenty-four hours. It is then heated to boiling and allowed to cool. The fruit may then be pressed and the resulting juice used for vinegar. Yeast should be added in the way described in paragraph 84.

**84. Addition of Yeast and Control of Alcoholic Fermentation.** The crushed fruit, diluted honey, and fruit juice prepared as described in paragraphs 81, 82, and 83 must be allowed to pass through an alcoholic fermentation. This is caused by yeast. The materials contain yeast that will cause fermentation, but usually the fermentation will be very poor and an inferior product will usually result because the yeasts naturally present are not of the proper varieties. Therefore, good yeast should be added.

All containers and other utensils coming in contact with the juices or fruits must be clean. Never under any circumstances add vinegar or vinegar mother to fresh juices before fermentation. They should only be added after yeast fermentation is complete.

If large amounts of vinegar are to be made, suitable yeast may be obtained from the College of Agriculture, University of California, Berkeley, California. This will be sent for one dollar, prepaid, with directions for use. It is more satisfactory than bread yeast.

To crushed fruit, compressed yeast is added at the rate of one cake per three gallons of crushed fruit. The yeast must be broken up thoroughly in the juice or crushed fruit. This can be done by mixing the yeast



with a little juice or water and then stirring the yeasty liquid in with the crushed fruit.

Fruit juices and diluted honey are allowed to ferment until there is no longer any gas given off and until all taste of sugar disappears. This will be in about three weeks at room temperature.

Crushed fruits should be allowed to ferment about a week. This will soften them so that the juice may be pressed out easily. During fermentation, the crushed fruit should be stirred frequently and should be screened or covered with a cloth to keep out vinegar flies. The fruits are then pressed and the juice allowed to ferment until all the sugar is destroyed. Yeast fermentation proceeds most rapidly at warm temperatures. A temperature of about 80° to 90° F. is the most favorable. At temperatures above 105° F., fermentation ceases and at temperatures below 60° F., it proceeds extremely slowly. At 80° to 90° F. fermentation will usually be complete in two weeks or less. Because a warm temperature is so favorable, the stoneware crock or other container should be kept in a warm room, except in hot summer weather.

Vinegar flies often gather around fermenting fruits or juices. Their presence is objectionable, both because of their appearance, and the fact that they may infect the material with vinegar bacteria. Vinegar bacteria form vinegar acid which seriously interferes with and may stop yeast fermentation. It is essential that yeast fermentation run to completion in order that a strong vinegar shall be formed. The flies may be kept out of barrels or jars by the use of cheesecloth covers.

**85. Pressing Fermented Fruits.** The same equipment can be used as described under paragraph 29, "The Pressing of Fruits for Fruit Juice." If only a small amount (less than five gallons) of crushed fruit has been

fermented, it may be pressed through a cheesecloth. Usually a great deal of the juice may be poured off after fermentation is complete; this is especially true of soft fruits.

The pressed juice should be placed in clean containers. Alcoholic fermentation will continue for several days after pressing.

**86. Removal of Sediment.** When alcoholic fermentation is over, the yeast and coarse fruit, pulp, etc., will settle out. When this has occurred the fermented liquid should be drawn or poured off the sediment, because this material will affect the flavor of the vinegar. Usually settling will have taken place in a month after the start of alcoholic fermentation or within two weeks after alcoholic fermentation is over. A hose is used to syphon off settled fermented liquids from barrels; the liquid may simply be poured from a crock or jar into another similar clean container.

**87. Adding Vinegar Starter.** When the alcoholic fermentation is complete (but not before) the vinegar fermentation should be started by the addition of a small amount of vinegar. Never add vinegar until yeast fermentation is complete. This is when gas is no longer given off and there is no longer a taste of sugar. This may be done by adding one pint of barrel vinegar or new vinegar from a grocery store to each gallon of fermented liquid after drawing it off from the yeast sediment. To fermented orange juice add one quart of vinegar per gallon. If there is any vinegar on hand from previous home made lots, it may be used. The addition of several pieces of "vinegar mother" also greatly assists the start of vinegar fermentation.

The vinegar adds millions of vinegar bacteria which multiply rapidly in the alcoholic liquid and it also increases the vinegar or acetic acid so that molding and

growth of "wine flowers" cannot take place. Mold and wine flowers often spoil alcoholic liquids to be used for vinegar unless vinegar is added.

**88. Vinegar Fermentation.** Vinegar fermentation must not be allowed to start until after alcoholic fermentation is complete. Starting the vinegar fermentation is described in the preceding paragraph.

The mixed vinegar and alcoholic liquid must be so placed that a large surface is exposed to the air. If the

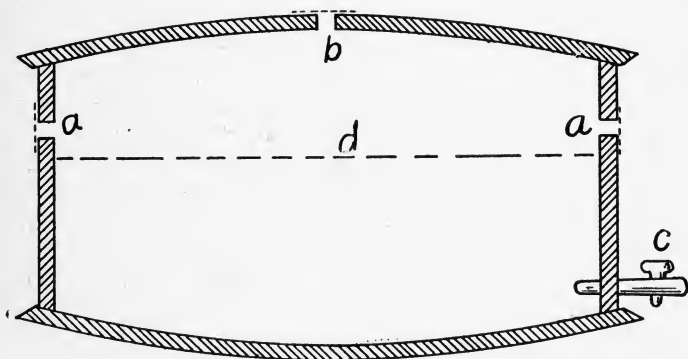

FIG. 49. Barrel Arranged for Vinegar Making. *a*, Holes for admission of air. *b*, Open bung hole. *c*, Spigot.

liquid is in a bottle the bottle should be filled only two-thirds full and must not be corked. A cloth only should be placed over the mouth of the bottle to keep out insects. A stoneware crock or glass fruit jar can be used. It should be covered with a cloth only. If a barrel is used, leave the bung open and fill the barrel only two-thirds or three-fourths full. The arrangement in Fig. 49 is very good.

Vinegar fermentation proceeds most rapidly in a warm room at 75° to 90° F. At this temperature, vinegar will

usually form in about three or four months. It will then be ready for filtration and use.

During the vinegar fermentation the liquid should be protected from vinegar diseases and pests as described in paragraph 84.

**89. Vinegar Generators.** The rate of vinegar fermentation depends on the amount of surface exposed to the air and to the temperature. Vinegar generators enormously increase the surface and hence speed up the rate of fermentation accordingly.

The most common type of generator is a wooden cylinder 8 to 12 feet high and about 30 to 40 inches wide. This is usually filled with beechwood shavings. Corn cobs, or rattan shavings may also be used. Charcoal or coke in large pieces may be used for distilled alcoholic liquids, but not for fruit

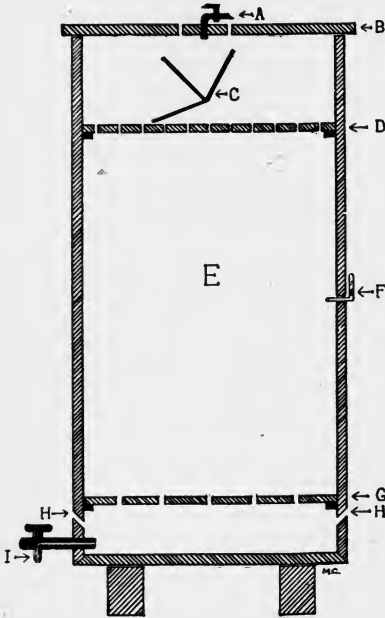

FIG. 50. Plan for Upright Vinegar Generator for Farm Use. A. Delivery pipe for fermented juice. B. Cover. C. Tilting trough to distribute liquid over false head. D. Perforated false head. E. Main cylinder of generator filled with shavings. F. Thermometer. G. Walls of generator. H. Air inlets. I. Outlet for vinegar.

juices because the material would soon become clogged with sediment.

The acidified fermented juice is run through the above

generator slowly (not more than twenty-five gallons per day). It is distributed over the perforated head of the generator by a tilting trough and trickles down over the shavings. Air is admitted through air holes near the bottom of the generator. Heat is generated by the fermentation and the temperature in the generator is maintained at 80° to 85° F. by regulating the rate of flow of liquid and air supply. A mixture of one part vinegar and three parts fermented liquid enters the top of the generator and vinegar issues from the bottom. The time for the liquid to flow through the generator is only a few minutes.

Considerable skill and experience are necessary to successfully operate vinegar generators and their use is recommended only for relatively large installations.

A simple generator for farm use can be constructed of a barrel filled with beechwood shavings and fitted with two wooden spigots and hole at each end. To operate this generator, it is filled half full with fermented juice acidified with one gallon of vinegar to each three gallons of liquid. The upper spigot is left open. The barrel is turned halfway over several times daily, closing the lower spigot and opening the upper spigot each time. Air enters holes in centers of ends of the barrel and flows out the upper spigot furnishing air to the liquid and vinegar bacteria on the wet shavings in the upper part of the barrel. A form of revolving generator is also used commercially.

The operation and construction of vinegar generators is very well described in a circular published by the Hydraulic Press Manufacturing Company of Mt. Gilead, Ohio. This company will send the above circular free on request.

Vinegar fermentation should be watched carefully and when the vinegar is strong enough for use it should be placed in completely filled containers such as barrels

or bottles. Where very large amounts of vinegar are made, the vinegar should be analyzed for acid content. The instrument shown in Fig. 51 is used by vinegar

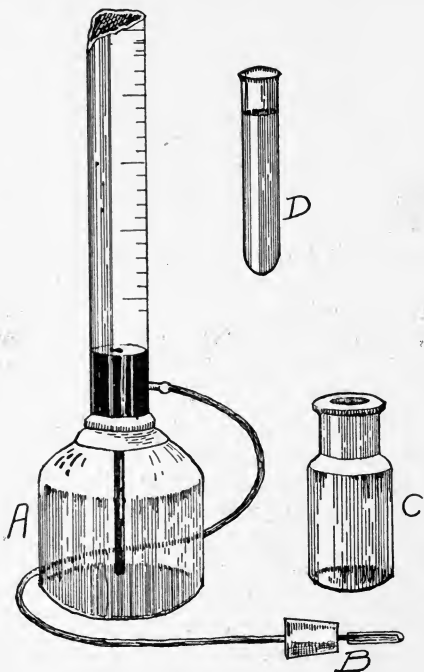

FIG. 51. Leo Acid Tester for Testing Strength of Vinegar. A. Water reservoir and graduated cylinder. B. Measuring spoon for baking soda. C. Bottle in which vinegar and soda are mixed. D. Tube for measuring vinegar.

factories. Directions for its use accompany it. It can be used by anyone.

**90. Aging of Vinegar.** Vinegar is greatly improved in flavor by storing for one year in well-filled closed wooden

barrels. It does not age very well in well-filled bottles and may deteriorate in open barrels and tanks after reaching its maximum strength. The bacteria form acid so long as any alcohol is left. When all of the alcohol is changed to acid, they attack the acid itself if the vinegar is exposed to air and may completely destroy all the acid or seriously lower the quality of the product. Hence the necessity for storing it in well-filled closed containers when the maximum acid content is reached. This point is determined by analysis with instruments shown in Fig. 51 if a large quantity of vinegar is made. In the household the taste will serve as a guide.

**91. Clearing the Vinegar.** If the vinegar is for home use it may be made sufficiently clear by straining through heavy cloth.

If it is to be sold, it may be necessary to clarify it by the methods outlined in Recipe 95. However, vinegar made in small quantities usually becomes clear after settling several months and only the sediment need be filtered or strained.

## **92. Vinegar Diseases and Pests.**

(a) Wine Flowers. This disease is caused by a film yeast growing on freshly fermented fruit juices and is seen as a white powdery or wrinkled and easily broken film. It is easily distinguished from vinegar mother because vinegar mother is thick, slimy, almost colorless, and tough. Wine flowers destroy the alcohol of the liquid and do not form any acid. They are especially dangerous in fermented orange juice or other fermented juices of low alcohol content. If vinegar at the rate of one or two pints to every gallon of fermented liquid is added when yeast fermentation is *complete*, there will be little danger of injury by wine flowers. Pure yeast added to the fresh juice before fermentation, also reduces the possibility of growth of wine flowers.

(b) Lactic Acid Bacteria. These grow in fermented

liquids producing disagreeable flavors and cloudiness. They can be controlled as directed for wine flowers.

(c) Vinegar Eels. These are small nematode worms just large enough to be seen in the vinegar when it is held to the light in a small glass tube or small tumbler. They are not especially harmful to health but their appearance is not pleasing. They may infest generators so badly that the generators cannot be used until the eels have been killed.

They may be killed by heating the vinegar to 120° F. in an agateware pot or by heating in some other way. Generators infested with eels are sterilized by live steam. Tanks in which infested vinegar has been stored should be steamed or sulphur should be burned in them several times so that the fumes will kill the eels. They can also be removed by close filtration. Eels will seldom appear in very small lots of vinegar, but are very common in vinegar factories where they usually do not become numerous enough to require repressive measures.



## CHAPTER XV

### FRUIT WINES

Fermented beverages from various fruits can be made successfully on a small scale on the farm without expensive equipment. Success depends upon the use of clean, sound fruit of good quality, care in manipulation, and the possession of a knowledge of the principles of fermentation. Control of fermentation is by far the most important factor concerned.

**93. Red Wine.** Red wine is made by alcoholic fermentation of crushed red wine grapes. The color of these grapes is in the skins and does not dissolve until fermentation takes place. It then dissolves in the fermented juice, giving the characteristic red color.

(a) **Crushing.** The grapes may be crushed in an apple or fruit crusher or with a heavy stick or with the hands. Use only clean ripe grapes; never moldy ones. It is not practicable to make less than five gallons of wine. Wooden containers are necessary for good results.

(b) **Yeast.** Compressed yeast or magic yeast cannot be used for wine. The grapes will ferment of their own accord, but may not give a good product. If only a few gallons of wine are to be made, the grapes may be allowed to ferment with the yeast naturally occurring on them. Better results will be obtained if yeast obtained from the Viticulture Division of the University of California, Berkeley, is used. This may be obtained for one dollar per culture. Directions for its use accompany the culture.

(c) **First Fermentation.** The crushed grapes are placed in an open wooden vat or open barrel or in a stone-

ware crock. The yeast from the University is added or the grapes are allowed to ferment spontaneously. They should be stirred well three times daily. Fermentation is allowed to proceed until almost all of the sugar is fermented. This will be in five to eight days at room temperature. By this time the wine should have become deep red in color.

(d) Pressing. The juice is pressed from the fermented grapes. A cider press or kitchen size fruit press may be used for small quantities. A jelly bag may also be used.

(e) Final Fermentation. The wine is transferred to barrels or casks. These are left open until the sugar is all fermented. This will take place in about two to three weeks. During this time the barrels should lie on their sides with bung holes up and open and they should be kept full.

(f) Settling and Filling Up. When fermentation ceases and the sugar is all fermented, the barrels are filled with other sound new or old wine and closed with bungs. They should be examined once daily for about two weeks, removing the bung or cork to release pressure of gas and then replacing it. This will prevent bursting of the barrels. As the wine cools it contracts in volume and more wine must be added occasionally to keep the containers full in order to prevent vinegar formation. Souring of wine is often caused by not keeping the barrels full.

(g) Racking. When the wine has settled for about a month, it is drawn off ("racked") into clean barrels, casks, or demijohns, and these are filled completely and closed.

(h) Aging. Newly made wine is not pleasing in flavor. It must be allowed to age in barrels or other closed and well filled wooden containers for at least a year before it should be used. The containers must be kept full and closed during this time. Wine improves with age up to a

certain point. Claret is usually best when three or four years old.

During aging, the flavor and bouquet of the wine develop by a slow oxidation process, brought about by the air which slowly gains entrance through the pores of the wood.

(i) Clearing the Wine. If properly made, wine will usually become clear of its own accord. If it should not do so, it may be clarified by filtration.

(j) Bottling. When the wine has acquired its best flavor (after two to four years for red wine), it should be bottled to prevent deterioration. The bottles should be well filled and corked with good quality wine corks so that the bottles will not leak. It is also a good plan to seal the corks with paraffin to prevent molding.

**94. White Wine.** White wine may be made in a small way on the farm in barrels or puncheons (180 gallon barrels), or in small casks. Demijohns or bottles may be used, but the results so obtained are not very satisfactory. A barrel or cask should be employed. White wine grapes of good quality only should be used.

(a) Crushing, Pressing and Settling. White grapes are crushed and pressed before fermentation. The juice is not allowed to ferment with the skins, in this way differing from red wine.

(b) Fermentation is carried out in barrels or puncheons, etc., with the bungs left open. Open vats are not used. The same care in fermentation should be given as for red wine (see paragraph 93). Fermentation should be complete in four or five weeks.

(c) Racking, Filling Up, Aging, Clearing, etc., are carried out as for red wine.

**95. Other Fermented Fruit Juices.** Hard cider and other fermented fruit juices are often made for home use. These may be used while still in fermentation, as "sharp" cider, etc., or may be allowed to ferment "dry," *i. e.*,

until no sugar is left and may then be allowed to age in wood before use. Or they may be bottled just before fermentation is over to produce sparkling drinks.

The juice is pressed from ripe fruit and allowed to ferment spontaneously or fermentation is induced by the addition of pure yeast from such a source as the University of California or some other reliable source. Compressed yeast can be used but may not give an agreeable flavor.

If the fermented juices are to be aged this must be done in wooden barrels or casks for the best results. Because of their low alcohol content, vinegar fermentation must be carefully avoided by keeping the barrels full; well closed, and in a cool place. These juices age very quickly and may be used in a few months after fermentation.

Pomegranates, pears, oranges, blackberries, raspberries, sweet plums, cherries, and peaches may all be used for hard cider. Peaches and pears may be pressed more satisfactorily if crushed and fermented before pressing.

## CHAPTER XVI

### PRESERVATION OF VEGETABLES AND FRUITS BY SALTING AND PICKLING

A great variety of pickles may be made from vegetables and to a less degree from fruits. These include such things as cucumber pickles, dill pickles, sauerkraut, ripe olives, and sweet fruit and vegetable pickles.

The preservation of vegetables by salting and fermentation involves principles similar to those of pickling, and, therefore, this method of preservation is considered with pickling.

**96. Preservation of Vegetables by Salt.** Many vegetables may be preserved in salt or strong brine without causing any marked changes in flavor or composition of the vegetables. The salt acts as an antiseptic and prevents spoiling. There are three ways in which the salt is used. The vegetables may be mixed with dry salt in sufficient quantity to completely prevent the growth of all microorganisms, or only a small amount of dry salt is added and fermentation is allowed to take place, the products of fermentation, together with the salt, preserving the vegetables; or a very strong brine may be made up and the vegetables stored in this without fermentation.

(a) **Dry Salting.** In this method the vegetables are prepared fresh as for cooking for the table. Carrots, beets, and turnips are peeled and sliced; string beans are broken into short pieces and corn is cut from the cob. Onions and peas do not respond well to salting. Corn and string beans are excellent when salted.

One pound of salt is weighed out and mixed with each

three to four pounds of vegetables in a stoneware jar or in an open barrel. The salt and vegetables are built up in alternate layers and a wooden cover to fit inside the container and heavily weighted, is placed on the vegetables. The salt and pressure draw the juice from the vegetables. This forms a concentrated brine in which the vegetables will keep indefinitely. They should be sealed with paraffin after about two weeks to check evaporation of the liquid. The vegetables must be freshened in water by soaking in cold water or by parboiling before use for cooking. They will keep indefinitely in this way.

(b) Salt and Fermentation. In this method a small amount of salt (one-half pound to each ten pounds of vegetables) is used. This permits the growth of yeasts and lactic acid bacteria, but prevents the growth of putrefactive bacteria. It does not prevent the growth of mold; molding must be checked by exclusion of air. The lactic acid formed in the fermentation is the main factor in the preservation of the vegetables. Cabbage, string beans, sliced beets, greens, sliced root vegetables, all lend themselves very well to this process. In Belgium and Holland, it is said that this is the most common way of preserving all kinds of vegetables.

Vegetables preserved by this method possess a "sauerkraut" flavor which varies with the kind of vegetable preserved.

The jar or barrel must be kept sealed after fermentation is over. Jars are sealed by pouring a thick layer of paraffin over the fermented vegetables. This is added ten days to two weeks after mixing the salt and vegetables. When vegetables are taken out for use the paraffin coating must be replaced in order that molding will not take place.

Barrels may be fitted with a six-inch bung in one head. The vegetables and salt are packed in with the head removed and is so left until fermentation is over. The bar-

rel is then headed up and brine of the same strength as that on the vegetables (one pound of salt per gallon of water) is added to fill the barrel completely and the barrel is sealed with the bung. As the vegetables are taken out they are replaced with brine.

(c) Strong Brine. A few vegetables cannot be preserved satisfactorily by methods "a" and "b." Some of these may be stored in a very strong brine made of three and one-half to four pounds of salt per gallon of water. No fermentation can take place in this high concentration of salt. Large peppers, cauliflower, artichokes, and asparagus, are examples of vegetables that can be successfully preserved in this way.

The vegetables will float because of the buoyant action of the brine. Wooden floats must be used to keep the vegetables submerged to prevent molding.

The vegetables must be freshened before use. A convenient way of doing this is to suspend them in a coarse bag or colander in the top of a large pot of water. The salt rapidly dissolves out and is carried away by the large volume of water beneath the vegetables. This

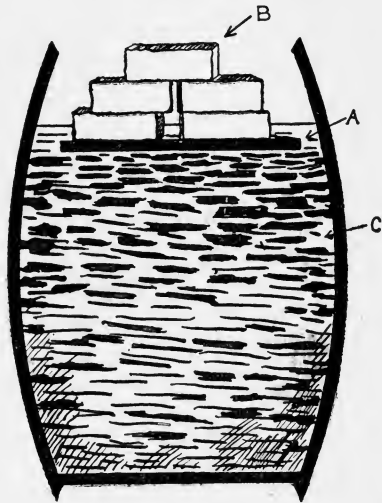

FIG. 52. Barrel or Other Container Arranged for Fermentation of Vegetables. A. False wooden head. B. Heavy weights. C. Prepared vegetables, salt and brine. When fermentation is over, seal with paraffin.

method is much more rapid than that of placing the vegetables in the bottom of a pot of water.

See Recipes 99, 100, and 101, Part III.

**97. Dill Pickles.** Dill pickles are made by the fermentation of cucumbers in a brine in the presence of dill weed and spices and with the exclusion of air. Lactic

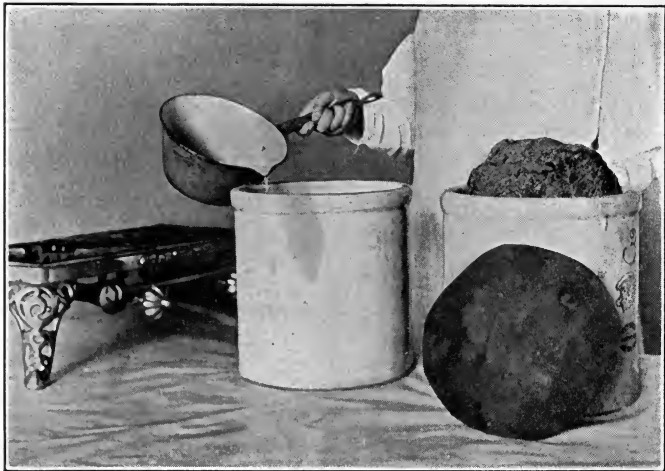

FIG. 53. Preserving Vegetables by Salting. On right, jar with vegetables mixed with salt and weighted down with heavy rock; on left, sealing jar of salted vegetables with paraffin after fermentation.

acid is formed and gives the characteristic sauer-kraut flavor to this style of pickle. The brine used is about one-half pound of salt per gallon of water. A small amount of vinegar added to the brine will prevent softening by injurious bacterial growth. The amount of vinegar needed is three-quarters of a quart per ten quarts of brine.

Dill pickles may be made in stoneware crocks, but



better results are obtained in barrels. Exclusion of air is essential.

Fermentation requires from five days to a month, depending on the temperature. The finished pickles should be canned and sterilized to prevent deterioration. (See Recipe 104 for specific directions.)

**98. Pickling Vegetables in Vinegar.** Cucumbers, green tomatoes, onions, small peppers, beets, and cauliflower are the vegetables most commonly preserved in vinegar. The processes of pickling consist of a preliminary treatment to prepare them for the vinegar and secondly, of the storage in plain or sweetened vinegar. The vinegar is the preserving agent, sterilization being unnecessary.

(a) Storage in Brine. Most vegetables for pickling should be stored in brine a few weeks to remove disagreeable flavors before placing them in vinegar. Cucumbers are stored for about two weeks in a brine consisting of one and three-fourths pounds of salt to the gallon of water; this is then increased to two and one-half pounds per gallon and the cucumbers held in this until needed for final pickling in vinegar. Fermentation takes place during storage, the green color fades to an olive green, the acrid flavor disappears, lactic acid is formed from the sugar, and the texture and flavor improved. The cucumbers must be kept submerged in the brine. This can be done with a wooden float. Should softening set in more salt must be added. Softening is the result of harmful bacterial or mold growth. This is checked by increasing the salt content. Onions, cauliflower, and green tomatoes are stored in a brine of three and one-half pounds of salt per gallon for two weeks or longer before pickling. Peppers are stored in wooden barrels, filled with a brine of the same strength as directed for use on cucumbers. After fermentation, the barrel is closed and stored until peppers are used in vinegar. Beets are not stored in salt.

(b) Removal of Salt. The salt must be removed from the vegetables by soaking in cold water, or by heating in several changes of water to about 120° to 150° F. A teaspoonful of alum per gallon of hot water used will make cucumbers more crisp. Several hours' heating are usually necessary to remove the salt.

(c) Addition of Vinegar. Good cider vinegar should be used. If the salt has been removed from the vegetables by soaking in cold water the vinegar is added to the pickles boiling hot; if it has been removed by heating in water to 120° to 150° F., the vinegar is added cold. The vinegar may be spiced or sweetened by methods given in Recipe 107. The pickles will be ready for use after two or three weeks' storage in vinegar.

**99. Pickling Fruits in Vinegar.** Fruits, especially figs and peaches, are often made into sweet pickles by the addition of a spiced and sweetened vinegar to the cooked fruit or by cooking the fruit in this sweetened liquor. (See Recipe 108.)

**100. Olives.** The olive pickling industry is one of the most important of California's fruit industries. Arizona is the only other state growing olives commercially.

Olives are pickled both green and ripe, although green pickled olives are no longer produced commercially in the United States.

Olives before pickling are extremely bitter in flavor. The pickling process is largely one of removing this bitterness.

(a) Pickled Ripe Olives. The olives should be of good pickling varieties such as Mission, Manzanillo, Sevillano, or Ascolano, and should be ripe. They are ripe when cherry red to black in color. They should not be overripe and soft or badly injured by frost.

Wooden or stoneware vessels must be used for olive pickling. Never use metal.

The first step in the treatment is the addition of a

lye solution of approximately three ounces (three table-spoonfuls) of soda lye to the gallon of water. This solution is allowed to penetrate through the skins of the olives and a little way into the flesh. The action of the lye is evidenced by a change in color of the skins of the olives and is also shown by darkening of the flesh of

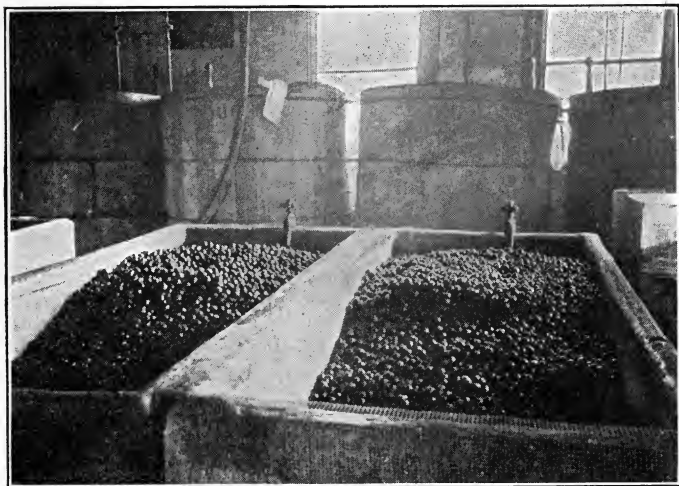

FIG. 54. Vats of Olives being Exposed to Air to Color Them during Pickling Process.

the fruit. If an olive is cut occasionally during the lye treatment, the action of the lye will be seen on the cut surface. The first lye is used to act upon the color in the skins so that it will turn dark on exposing the olives to the air. If it goes too deeply into the flesh the coloring during air exposure will not be satisfactory. It will usually take from three to eight hours for the lye to penetrate sufficiently. The lye is then removed and placed in another vessel. The olives are left exposed to the air in the vessel in which lye treatment took place.

They are stirred three or four times daily. Two to four days' exposure will usually be sufficient to darken the olives. Exposure is necessary because the lye treatment bleaches the natural color of the olive more or less. Exposure to air injures the flavor and texture



FIG. 55. Interior of Large Olive Pickling Plant.

slightly and if a dark color is not desired the exposure part of the process may be omitted.

When the olives have acquired the desired color the lye is returned to them to remove the bitter principle. The lye must be left on the olives the second time until it reaches the olive pits. This will be in about twenty-four hours. It dissolves and destroys the bitter compounds.

The lye is then removed and discarded. The olives are then covered with water which is changed twice daily until no taste of lye is perceptible. This will require about a week's time.

The olives are then sterilized in jars or cans in a brine of five ounces (five tablespoonfuls) of salt per gallon of water. They must be sterilized in boiling water one hour. Any of the sterilizers described under canning of fruits and vegetables may be used.

(b) Green Olives. Olives for green olive pickles should be of full size, but still green in color. They are placed in a lye solution of three ounces per gallon and left until the lye reaches the pits. This destroys the bitterness. The lye is washed out with repeated changes of water. This must be done without exposing the olives to the air in order that darkening of the olives shall not take place. Green olive pickles should be light yellowish green when pickled and should not be brown in color. The olives are then placed in barrels or jars and covered with a brine of nine ounces (nine tablespoonfuls) of salt per gallon. The barrels or jars should be completely filled with brine and sealed with a bung or well fitting top. Fruit jars may be used for small quantities. Air must be excluded in order that lactic acid fermentation but not molding may take place. The reason for placing the olives in the brine is to permit lactic acid fermentation to take place. This produces the characteristic green olive flavor and texture. If the brine is too weak they will soften. If it is too concentrated they will not undergo fermentation. Barrels are the most satisfactory containers. They should be full and closed.

The barrels or jars are left in a warm place until the olives have reached the desired flavor. They are then removed, placed in olive or fruit jars, the brine is filtered, and poured on the olives boiling hot and the jars are sealed. No further sterilization is necessary.

(c) "Greek" Olives. Olives may be cured without the lye treatment by mixing one pound of salt to each three pounds of olives used. The salt and olives are built up in alternate layers in a crock or tank or barrel and left

until the proper flavor has developed. The olives are covered with a thick layer of salt. The salt destroys the bitterness and draws out some of the moisture from the olives to such an extent that when they are removed from the salt no sterilization is necessary to keep them. The salt is brushed off the olives after the bitterness has disappeared. This will be in four to six weeks. They are stored in jars or boxes. This style of olive is used very extensively by the Italian and Greek population in America. Such olives contain most of the food value of the olive and possess more of the fresh olive flavor than do olives pickled in the usual way.

**101. Tomato Ketchup.** This product is made in enormous quantities and is used on practically every table. Most of it is made in factories, especially equipped for this purpose. It can, however, be made on a small scale.

The material used should be of best quality and free from moldy or soured tomatoes. Firm varieties, such as the Stone are preferable to the watery, less pulpy varieties because the pulp will require less boiling down and will be of better color. The various steps in tomato ketchup manufacture are (a) preparation of the pulp, (b) seasoning the pulp, (c) concentrating, and (d) sterilizing.

(a) **Pulping.** The tomatoes in commercial factories are broken up finely in a "cyclone" machine and the pulp forced through fine openings which hold the skins and seeds. In the kitchen, pulping is accompanied by boiling the crushed tomatoes a short time followed by forcing the juice and pulp through a fine screen to remove skins and seeds. These must be removed if an attractive product is to be made.

(b) **Addition of Flavoring Materials.** Sugar, vinegar, pepper, salt, onions (usually), cayenne pepper, and various other spices are added to the pulp. Paprika is

often added in large quantities to impart a deep red color. The onions are added before cooking. The other spices are usually added after the ketchup has been partly boiled down so that the flavor will not be lost by boiling.

There are several ways of adding the spices. One of the best methods is to suspend the whole or coarsely ground spices in a bag in the ketchup during boiling. The flavor is extracted from the spices in this way. If ground spices are added directly to the pulp there is danger of darkening the product too much; for home ketchup making this, however, is not a serious defect and is more economical of spices. Acetic acid or oil solutions of spices are also used.

(c) Boiling. The pulp is boiled down to about two-thirds or one-half the original volume. Half of this boiling is carried out before the spices are added. Boiling should be rapid and burning avoided by stirring. Long boiling gives a dark color. There is no simple way of determining when the ketchup is done, except by taste and appearance. When it has reached the desired consistency it is ready for bottling.

(d) Sterilizing. The hot ketchup is poured into scalded bottles or jars. Bottles are sealed with scalded corks. Bottles should be sterilized in boiling water forty-five to sixty minutes to kill mold spores. Jars may be sterilized one hour in a washboiler sterilizer as previously directed for fruits. Ketchup may also be put up in cans.

## **102. Miscellaneous Tomato Products.**

(a) Tomato Paste. Tomato paste is tomato pulp flavored or unflavored, as desired, which has been concentrated to about one-tenth to one-twelfth the original weight of pulp taken. It is used as a flavoring and as a base for soups, in combination with rice, spaghetti, etc. It need not be sterilized and can be stored in jelly glasses,

jars, etc., sealed with paraffin. In making the paste the skins and seeds are removed from the tomato pulp by screening. The pulp is then boiled down slowly and finally concentrated to a thick paste on the back of the stove or in the sun in shallow pans. It is used extensively by the Italian population under the name of "consève."

(b) Purée. Tomato purée is fresh pulp freed from skins and seeds. It is sterilized in cans, bottles, or jars. It is usually not concentrated before sterilizing, although container space is saved by boiling the purée down before canning.

(c) Chili Sauce, Piccalilli, and Relishes. These are various forms of chopped tomato relishes, flavored in various ways and consisting of various combinations of other vegetables with tomatoes. Some of these are made from green and others from ripe tomatoes. Recipes for the above products will be found under Part III.



## CHAPTER XVII

### PRESERVATION OF MEAT

It is often desirable to preserve surplus meat in some attractive and palatable form in the household or on the farm. Occasions will often arise where there will be pork or beef to salt or smoke; fish to salt, smoke, or can; and chicken or rabbit to can. The following discussions on meat preservation and the recipes given in Part III of this book are intended to give the principles of meat preservation and specific directions for carrying out the actual processes. The preservation of eggs is also included with the discussion of meats.

**103. Salting Meats.** The custom of farmers salting down the winter's supply of meat, once so prevalent, is now much less popular than in former times. It is still, however, of great economical importance. The great packing houses now supply cured meats to the farmers who raise the pork and beef from which the bacon, etc., is made. Preserving meats by salting is not a difficult process and can be carried out on the farm with ordinary equipment at hand.

(a) **Dry Salting.** This method is used more commonly for fish than for other meats, although it is used quite frequently for pork also. The meat must be fresh but should not be salted until the animal heat has disappeared. Frozen meats do not take up the salt satisfactorily. Stoneware crocks or good clean barrels are used to hold the salted meat. Pork and beef are cut in medium size pieces; fish are cut in half and heads, fins, and backbone are removed unless the fish are very small. For each 100 pounds of meat, ten to fifteen pounds of

salt is weighed out. Salt is thoroughly rubbed into each piece of meat and the salted meat is packed in alternate layers with the salt in a clean barrel or crock, the last layer of meat being thoroughly covered with salt. A heavy weight is placed on the meat. Pork and beef should be removed three or four times during the first two weeks and rubbed thoroughly with salt. Dry salting is used more often as a preliminary treatment to smoking than as a means of permanent preservation.

A small amount of saltpeter and pepper is often added to hold the color of the meat and to add flavor.

Fish are left in the salt without removing to rub with more salt. Fish improve with age up to a year. A rather coarse salt should be used.

Dry salting of meat tends to dry the meat considerably by drawing out the moisture to form a brine. Its use, except for fish, requires considerable experience and skill to attain uniformly satisfactory results. The preservation in brine requires less experience and is recommended in preference to the dry-salting method.

(b) Preserving Meats in Brine. A strong brine makes a convenient preservative solution for meats. This brine may be made of salt and water alone, but it often contains other ingredients such as spices, sugar, and saltpeter. The saltpeter is used to preserve the bright red color to meat.

The brine used must be a practically saturated solution of salt to prevent putrefaction. This is especially true of fish. Barrels, crocks, etc., must be thoroughly cleaned and scalded before use. Brines should be heated to sterilize them and allowed to cool before they are used.

Pork and beef are rubbed with ten pounds of salt per 100 pounds of meat and the dry salt and meat are allowed to stand overnight before the brine is added. A brine is then added. A typical brine consists of ten pounds

of salt and two ounces of saltpeter per four gallons of water. This is about enough brine for 100 pounds of meat. The meat is kept submerged by wooden floats until used.

The meat should be stored in a cool place. If the brine should at any time become slimy or should the odor become objectionable it should be changed and fresh brine added. Beef and pork will keep indefinitely in this way, although in time the flavor and quality deteriorate.

Fish are put down in a brine of about three and one-half pounds of salt per gallon of water and stored until used. Corn beef brine contains saltpeter, sugar, and baking soda.

**104. Drying Meats.** Meats may be dried with or without previous salting, provided a dry hot climate is available. Venison is often sun dried after sprinkling strips of the meat with pepper to keep away insects. The venison is cut in strips about three-quarters of an inch thick and hung on a line to dry. Salt may be used before drying, but makes the product tough and unpalatable. The dried venison is known as "jerkey."

Beef may be dried in the same way as venison.

Fish is often dried. It is first stored about sixteen to twenty-four hours in a strong brine of three pounds of salt per gallon of water. It is then dried.

Meats that have been salted may be dried even in a coast climate. Fish are dried in great quantities along the seashores of all maritime countries. Without fairly heavy salting to prevent the growth of putrefactive bacteria this would not be possible.

**105. Preservation of Meats by Smoking.** Smoke contains certain compounds of a creosote nature that act as powerful preservatives. It also imparts an agreeable flavor to meats.

(a) Salting. Meats are usually stored in salt or brine

a short time before smoking. This assists in the preservation of meat, adds to the flavor, and reduces the moisture content of the meat slightly. Smoking further reduces the content of water.

The strength of the brines used with different meats, the ingredients besides salt, and the length of storage

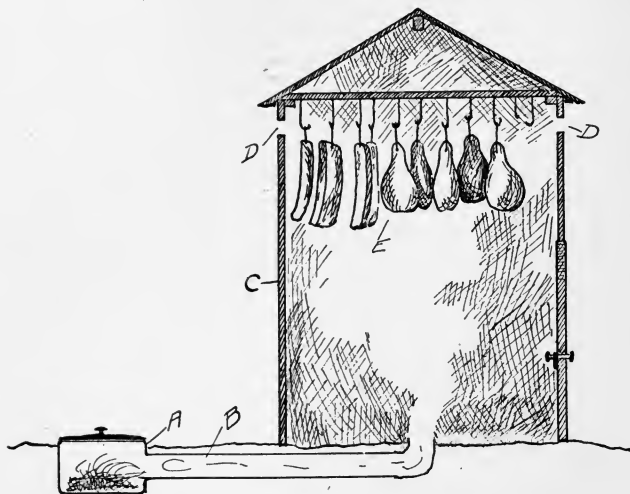

FIG. 56. Home-Made Smoke House.

vary. Fish are stored for only about sixteen hours in a strong brine. Pork is stored about three weeks before smoking. The brines used for various meats are given under meat preservation recipes of Part III.

(b) The Smoke House. The meat is usually rinsed in warm water after removal from the brine or salt and is allowed to drain before hanging in the smoke house.

The smoke house may be merely a large box made almost air-tight; a large barrel or dry goods box will answer for small amounts of meat. This is arranged with

wire netting shelves to hold the pieces of meat or with hooks from which the meat is hung. A hole about fifteen inches deep is dug in the ground and the bark or other source of smoke is burned in this. This sort of a smoke house is very satisfactory for fish because the flavor and texture of the fish is improved by the relatively high temperatures resulting from this arrangement.

Bacon, hams, and beef should, however, be kept as cool as possible. The arrangement shown in Fig. 56 is well suited to the purpose. The smoke is generated outside the house and is conducted to the floor of the house by means of several pieces of stove pipe. The house should be tall so that there will be as little heat as possible. A little ventilation is necessary to draw the smoke from the fire box to the house. If the ventilators are placed just below the level at which the meat hangs, the upper part of the house and the meat will hang continually in a dense cloud of smoke. The openings should be arranged so that they may be regulated. Dense smoke without heat is essential except in freezing weather. If the meat becomes frozen the smoke will not penetrate and where freezing is apt to occur it will be necessary to arrange for heating the house.

(c) Smoke Producing Substances. A great variety of substances are used for smoking meats. Spent tan bark from tanneries is one of the best materials for smoking purposes. It imparts an agreeable flavor and odor and also gives a dense smoke without much need of close attention. Hickory chips and other hardwood chips, or hardwood sawdust give good results. Corn cobs may be used, but do not produce such a desirable flavor as does tan bark or hardwood. The smoke-producing material should not blaze; this can be prevented by proper regulation of the ventilation or by smothering the flame with moistened tan bark or hardwood sawdust, etc. So-called "liquid smoke" preparations

may be purchased. These are chemical solutions which produce a smoked taste in bacon or ham when rubbed on the meat. Their use is not so satisfactory as smoking.

(d) Length of Smoking. Fish are smoked less than twenty-four hours, because they take up the smoke very quickly. The meat is smoked until it has reached the proper color, texture, and flavor. For pork, this will ordinarily be in one to two weeks. If the meat is to be used soon after smoking, a short period of smoking will be more satisfactory than a long one. Meat, to be kept a long time, must be thoroughly cured by smoking to prevent spoiling.

Beef is smoked thoroughly and then hung in a warm dry place to become as dry as possible. It is known as dried beef rather than smoked beef.

(e) Storing Smoked Meats. Cured bacon and ham may be kept by wrapping in heavy parchment paper and then in heavy wrapping paper and storing the wrapped meat in a cool dry place.

If the smoke house is not needed for other purposes the meat may be left hanging in this. Smoke may be started occasionally to drive away insects. Pepper rubbed on the surface of the meat will also act as insect repellent.

Ham and bacon may also be kept by placing the pieces on a layer of sifted ashes and covering with a thick layer of the same. Beef should be hung in a dry place. Fish should not contain too much moisture before storing. It will usually be necessary to dry the smoked fish several days in the sun before storing.

**106. Miscellaneous Meat Products.** Lard, mince-meat, head cheese, sausage, pickled pigs' feet, and other meat products may be made on the farm. They are of less importance than the methods of preservation just discussed and are to be considered more as means of preparing meat for the table than as methods of preservation, the subject with which this book aims to deal.

**107. Preservation of Eggs with Water Glass.** Water glass is a clear sirupy liquid that may be obtained from drug stores and often from groceries for the preservation of eggs. It is used in two ways.

It may be diluted with from nine to twelve parts of water to one part of water glass and used as a liquid in which the eggs are stored. Tin, glass, stoneware, or wooden containers may be used. The container should be well covered to prevent evaporation of the water and the eggs should be well covered with the liquid.

In the second method the eggs are dipped in a solution of one pint of water glass to three pints of water. They are drained and allowed to dry on a layer of flour or corn starch or precipitated chalk. When dry they are dipped in the water glass and dried as before. They are then packed in bran or saw dust. The water glass acts as an air tight seal.

Eggs will keep a year or more by either method. *Fresh clean* eggs must be used. Do not wash them. Use non-fertile eggs if they can be had. The eggs should be kept in a cool place.

Eggs stored in water glass will in time develop a slight stale taste, but will still be wholesome. They are not so suitable as fresh eggs for frying because the yolks are apt to break. They should not be used for hard boiling as a "sulphur" odor may develop if the eggs have been kept several months in the solution. For other purposes they are very satisfactory.

## CHAPTER XVIII

### MILK PRODUCTS

The manufacture of condensed milk, dried milk, cheese, and butter constitutes a series of very important dairy industries. A full discussion and description of these industries would be entirely outside the scope of this book. In the following pages only that material is taken up which will be of most interest and value to those desiring to preserve moderate amounts of butter or who desire to make a small amount of cheese or who wish to pasteurize milk in a small way. No attempt or claim is made to give a description of commercial installations or practices.

#### **108. Sterilization and Pasteurization of Milk.**

(a) Sterilization. Enormous quantities of canned milk are used. Commercial factories concentrate milk before canning and sterilization. This must be done in a vacuum evaporator and cannot be carried out on a small scale. Milk may be sterilized in sealed cans under steam pressure at ten pounds' pressure for forty minutes or for one hour at 212° F. on each of three successive days. Milk is exceedingly difficult to sterilize because of the spore-bearing bacteria present. There is, however, very little need of sterilizing milk in the household because it is usually not necessary to keep it more than two or three days. Pasteurization is, however, useful.

(b) Pasteurization of Milk in the Household. Milk heated to 140° to 160° F. will keep much longer than unheated milk. Heating to this temperature kills many of the bacteria and so weakens those not killed that their growth is very much slowed up.



Pasteurization may be accomplished in bottles or in open pots. If carried out in bottles the bottles should be scalded before filling. The filled bottles should be sealed with sterilized corks. They may be heated in a pot of water with bottles completely immersed until the water reaches 150° F. Maintain at this temperature for twenty minutes. Remove and cool. A thermometer must be inserted in the water to test the temperature.

The milk may also be pasteurized by heating in a pot to 145° F. at which temperature it is maintained for twenty-five minutes. A double boiler is best. Pour into scalded jars or bottles. For practical purposes milk may be pasteurized by heating in a pot to the simmering point or by "scalding"; that is, heating to boiling. This is often necessary for the keeping of milk in hot weather.

Pasteurized milk will keep considerably longer than the unpasteurized, and will not contain living typhoid or tuberculosis bacteria. Where there is any suspicion that milk may be infected with disease organisms it should be pasteurized; or if a thermometer is not available it should be heated to boiling ("scalded") before use.

**109. Storage of Butter.** Butter may be kept very satisfactorily in cold storage, but this is rarely available on the farm. The most practical method for farm use is preservation by salting. Butter should be kept cool, excluded from the air and away from the light. The spoiling of butter is brought about by the formation of fatty acids from the butter fat and the decomposition of the proteins and sugar in the buttermilk left in the butter. These changes are largely bacterial in nature, although partly a simple chemical change. Exclusion of air lessens the tendency for decomposition by bacteria.

Preservation by salt may be accomplished by adding from one-half to one pound of salt to each ten pounds of butter. The salt is worked in thoroughly. The butter is packed tightly in crocks and covered with salt.

Butter may also be preserved by adding one-fourth to one half a pound of salt to each ten pounds of butter and then storing the salt in a saturated brine (three and one-half pounds of salt per gallon of water). This is the usual household method. Such butter should be "freshened" by working in cold water before use.

Butter contains casein and buttermilk which tend to decompose. These can be removed by heating the butter in boiling water a short time. The casein is coagulated and falls to the bottom of the pot. The melted fat may be skimmed or poured off without mixing any water with it. It is then poured in dry jars, allowed to cool, and is sealed with paraffin. The butter is stored until it is to be used and keeps well in this form. It must be salted before it is used.

#### **110. Cheese.**

(a) "Cottage" Cheese. The only cheese that may be made satisfactorily without special experience and training is "cottage" cheese or "schmier kase." Formerly this product was made only in the home. In recent years, however, it has been made in large quantities for sale in delicatessens, restaurants, and cafeterias.

Skim milk is ordinarily used. It must be clean and of good quality. The first step is the formation of the curd. This is ordinarily accomplished by permitting the milk to sour naturally or by addition of a starter of lactic acid bacteria. It may also be accomplished by the addition of rennet, as in the making of hard cheese, but this produces rather a tough curd. Seventy degrees Fahrenheit is considered the best temperature for souring of the milk.

The curdled milk must next be heated to coagulate the curd. This should not be carried out at too high a temperature, or the curd will be tough and dry. The milk should be heated slowly to about 100° F., *i. e.*, blood temperature or a little higher and kept at this temperature until the curd seems firm and the whey clear. About

half an hour's heating at this temperature will be sufficient.

The curd is then drained through a cheesecloth for several hours. It is then broken up with a wooden potato masher or with the hand. About one ounce (one tablespoonful) of salt is added to each five pounds of curd. Other flavorings, such as finely chopped pimento, or black pepper, or various spices may also be added. "Pimento" cottage cheese is especially popular in California. If a rich flavor is desired, cream or melted butter is added and worked into the cheese.

Cottage cheese must be used within three or four days after it is made and is best when fresh. It does not ripen and improve with age in the way that other cheese does.

(b) Cheddar Cheese. This is the most common type of American cheese. It is made from whole milk. It cannot be made very successfully without considerable experience.

The first step is the souring of the milk to .2% acid. This is done by the addition of a starter of lactic bacteria and must be carefully watched by a chemical determination of the acid.

Rennet is then added. This is a substance obtained from the lining of calves' stomachs. It may be purchased also under the name of junket tablets. Rennet coagulates or curdles the casein. The curd is cut into cubes and left until the acid reaches 1%. It is then salted, pressed, and left to ripen.

The ripening process is a very complex one brought about by bacterial and enzyme action. Lactic acid is formed from the milk sugar left in the curd; the casein or curd is softened and partially decomposed and the butter fat undergoes partial decomposition. Most of these changes are brought about by bacteria occurring in the milk.

(c) Other Types of Cheese. There are numerous other

types of cheese. Space will not permit their discussion here. Bulletin 146 of the Bureau of Animal Industry of the United States Department of Agriculture gives good descriptions of the various types. This bulletin may be obtained free of charge by writing to the United States Department of Agriculture, Washington, D. C. It is not recommended that the making of cheese (except cottage cheese) be undertaken on the farm unless in a small experimental way and with the personal advice and supervision of some one experienced in cheese making. Recipes for cottage cheese and gouda cheese will be found in Part III.

## PART III

### FOOD PRESERVATION RECIPES

The first two divisions of this book have been devoted to a discussion of the principles of food preservation and general descriptions of processes. The third division, *i. e.*, Part III, gives working directions for the carrying out in the household or on the farm, of the various food preservation methods. Very little discussion accompanies the recipes. It is strongly advised that the corresponding discussion in Part II be read before taking up the actual directions of the recipes. This will give a better understanding of the recipes, so that they may be followed to better advantage.



## CHAPTER XIX

### FRUIT CANNING RECIPES

The following recipes contain directions for the canning of the most important fruits.

A discussion of the principles of fruit canning will be found in Chapter III.

#### (1) **Canning Peaches.**

1. Pick the fruit when firm ripe. It should be canned as soon after picking as feasible. If for sale sort into three grades for quality. These may be called Extra Fancy, Fancy, and Pie grade. The largest and most perfect fruit forms the first grade; medium size and quality, the second grade; and the soft, small, and blemished fruit is placed in the Pie grade.

2. Peel the fruit, preferably by hand. The peeling knife illustrated in Fig. 2 will be found very useful. Lye peeling is not recommended for small quantities of fruit. See Recipe 4. The skin may be slipped from some varieties of peaches after scalding in hot water and chilling in cold water.

3. Cut freestone peaches in half and remove pit. Cut clingstone peaches to pit around narrow side of the fruit. Insert pitting spoon at stem end, cut one-half of fruit from pit; the peach then falls in halves and the pit may be scooped from the adhering half by means of the pitting spoon. See Fig. 2. If the clingstone peaches are soft or difficult to pit when peeled, they should be pitted before peeling.

4. *Addition of Sugar.* If three grades of fruit have been made, add  $\frac{3}{4}$  pound of sugar to each pound of fruit of first grade; to the second grade  $\frac{1}{2}$  pound, and to the

pie grade, no sugar. If no grading has been done, add  $\frac{1}{2}$  to  $\frac{3}{4}$  pound of sugar per pound of fruit, depending on the degree of sweetness desired. Add just enough water to prevent scorching. Heat slowly to boiling and boil two or three minutes. This causes the fruit to shrink before canning. Do not cook too long.

5. Pack boiling hot into scalded jars or cans; fill with sirup formed in heating. Place scalded rubbers and caps on jars but do not screw down tightly. Place caps on solder top cans; seal and tip as directed in step 7.

6. *Sterilizing.* Place jars in washboiler or other sterilizer (see Fig 14), with hot water in boiler half-way up sides of jars. Heat water to boiling and keep boiling about 15 min. for freestone varieties and 20 to 30 min. for firm clingstone varieties, such as Philips and Tuscan. Remove and seal. Wax top cans are treated in same way as jars; the wax is not added until the fruit is sterilized in the cans. Sterilize solder top cans in boiling water after sealing; No. 1 and No. 2 cans 10 min. for soft fruit, 15 min. for firm clingstone peaches; No. 2 $\frac{1}{2}$  and No. 3 cans 15 min. for soft fruit and 20 min. for firm clingstone varieties; No. 8 and No. 10 cans, 30 to 40 min. Chill in cold water after sterilizing. The times given will vary somewhat with the condition of the fruit. It is a good plan to first sterilize two or three cans as a test before canning any large quantity of the fruit.

#### 7. *Sealing Solder Top Cans.*

Equipment: (1) capping steel,  
 (2) tipping steel,  
 (3) soldering fluid,  
 (4) small bristle brush,  
 (5) a gasoline torch or gas flame to heat  
 the irons.  
 (6) wire solder.

*Tinning the Steels.* The points of the soldering steels must be kept bright and coated with solder to be usable.



Often the steels become overheated and the coating is burned off. The steel must then be heated hot enough to melt solder readily. The encrustations of burned solder must then be filed off with a sharp file until the iron surface is well exposed. The hot steel is then dipped momentarily in soldering fluid and the surface is coated with solder or "tinned" by melting wire solder against the working surface; or the filed hot steel is tinned by turning it in a mixture of crystals of sal ammoniac and small pieces of solder. The steel must be kept clean and free from carbonized sirup, corroded solder, etc., by wiping with a stiff rag and occasional filing. Disappointment always ensues when dirty steels are used. See appendix for method of making soldering fluid.

*Heating the Steels.* To start the gasoline torch, pump the reservoir to good air pressure; fill the cup of the burner with gasoline by opening the cock; close the cock and burn off the gasoline to heat the burner jet hot enough to vaporize the gasoline; open the cock and light the burner. It should burn with a roaring blue flame, not a smoking luminous one. If it does not do so, increase the air pressure and heat the vaporizing jet of the burner until a good flame results. Place the steels in the flame and heat until they will melt solder quickly, but not hot enough to burn off the "tinning." Experience is the only guide.

*Cleaning the Surface of Can and Can Top.* After the can is filled, wipe out groove carefully with a clean cloth. Apply lid. Clean the surface of groove and edge of lid for soldering by brushing lightly with a small bristle brush dipped in soldering fluid.

*Soldering the Cap.* Clean the point of the hot capping steel with a cloth. Dip the steel in soldering fluid an instant. Apply the steel to the groove of the can. If solder hemmed caps are used no solder need be added. If plain caps are used, a little solder must be melted into

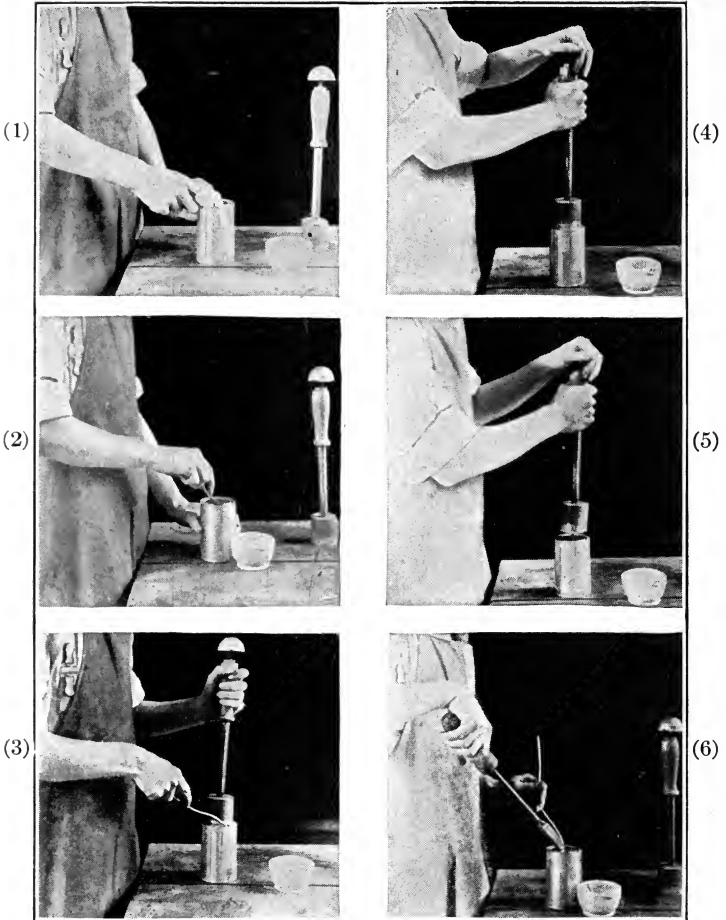

FIG. 57. Capping and Tipping a Solder Top Can. (1) Wipe off groove and cap with cloth to remove sirup, pulp, etc.; (2) Wipe groove with brush dipped in soldering fluid; (3) Apply hot capping steel and melt solder of solder hemmed cap or melt a little solder from solder wire; (4) Turn the steel two or three turns backward and forward to distribute solder evenly; (5) Raise the steel, but hold lid down for 2 or 3 seconds by center rod to allow solder to set; (6) wipe vent hole with soldering fluid; apply hot tipping steel and seal with drop of solder.

the groove by pressing a strip of wire solder against the lower part of the steel. Turn the steel around two or three times in the groove to distribute the melted solder. Raise the steel and press down on the rod through the center of the steel a second or two to permit the solder to set enough to hold the lid in place. Remove the steel. One heating of the steel is usually enough for six to ten cans.

*Tipping.* After the can has been capped and "exhausted" or heated to expand its contents, the small hole in the center must be closed before sterilizing the can. To do this, heat the small pointed tipping steel. Clean the point. Dip it in soldering fluid. Clean the vent hole with the bristle brush dipped in soldering fluid. Melt a drop of solder over the hole with the point of the steel. With a little practice this can be done quickly and neatly.

## (2) Alternative Methods for Canning Peaches.

### Alternative Method A

In this method all of the cooking of the fruit is carried out in the can or jar. Do not cook before canning.

1. Make a 60° Balling sirup for first grade fruit ( $12\frac{3}{4}$  pounds of sugar per gallon water); see table 3; a 40° sirup for second grade fruit, and use plain water for pie stock.

2. Pack the peeled and pitted fruit in cans or jars. Fill with boiling hot sirup or water (according to grade of fruit).

3. Sterilize in jars as in Recipe 1 for 20 min. at 212° F. for freestone peaches and 25 to 30 min. for clingstone peaches; 15 min. in cans for freestone peaches and 20 to 25 min. for clingstone peaches.

### Alternative Method B. Use of Fruit Juices Instead of Sugar

When sugar is very scarce and expensive the amount needed for canning can be greatly reduced or in some

cases sugar may be omitted entirely by using the following method:

1. Press and strain the juice from ripe grapes or apples or other fruit available. It should be strained boiling hot.

2. To the strained juice add baking soda in very small amounts. Stir after each addition and taste. Continue the additions until almost all of the acid or tart taste has disappeared. If this is not sweet enough add sugar to taste. Omit soda if juice is very sweet.

3. Pack the prepared fruit in cans or jars. Heat the juice to boiling and fill the jars and cans with it. Sterilize in the containers as directed in Alternative Method A above.

### (3) Canning Apricots.

1. Use ripe fruit that is not too soft. Grade into Extra Fancy, Fancy, and Pie Grades.

2. Wash, cut in half and remove pits. Do not peel.

3. Add  $\frac{3}{4}$  pound sugar to each pound of best grade fruit; one-half pound to second grade, and none to third grade. Add a small amount of water to prevent scorching. Bring to a boil for 2 or 3 min.

4. Pack hot into jars or cans. Seal and tip cans, but leave caps and rubbers loosely on jars.

5. Sterilize cans of No. 1 and No. 2 sizes, 8 min.; No. 2 $\frac{1}{2}$  and No. 3, 15 min.; No. 8 and No. 10 cans and jars 20 to 25 min. Count time after the water boils. Use washboiler or other convenient sterilizer. Chill cans in water after sterilizing. Seal jars and wax top cans after sterilizing.

6. *Alternative Methods for Apricots.*

#### Alternative Method A

Make 60% and 40% sirups. Pack pitted fruit in cans or jars cold. Add hot 60% sirup to Extra Fancy, 40% to Fancy, and water to pie fruit. Seal cans. Sterilize as

in above method but increase the time 5 min. in each case.

#### Alternative Method B. Canning in Fruit Juice

The method for canning peaches in fruit juice de-acidified with baking soda may be used for apricots. Omit soda if juice is sweet. See Recipe 2, Part B.

#### Alternative Method C. Lye Peeling

Apricots may be lye peeled by the method given in Recipe 4. It is, however, not recommended for home use.

#### (4) Lye Peeling Peaches and Apricots.

This method of peeling is not strictly suited to home use, but may be useful in larger scale operations.

1. Prepare a 10% lye solution, 12 ounces of lye per gallon of water. Heat this to boiling in an iron pot or tank; do not use aluminum or tin. Keep at the boiling point.

2. Cut peaches and apricots in half and remove pits. The fruit must be firm.

3. Immerse the fruit in the boiling lye long enough to separate the skins from the flesh. This will take 30 to 60 seconds. A metal conveyer is used in factories to carry the fruit through the boiling lye. A wire basket will answer for home use.

4. Immerse the fruit in cold water after dipping and wash off the loosened peels. Rinse in water till all lye is removed. The loosened skins can also be removed by vigorous sprays of cold water. All lye must be removed or the fruit will darken.

5. The peeled fruit is then ready for canning or drying.

#### (5) Canning Pears.

The Bartlett pear is the most popular for canning.

1. Gather the fruit when it has reached full size but is still hard in texture. Allow it to ripen in a cool, shady

place. The flavor and texture of fruit so ripened are superior to those of tree ripened fruit.

2. Peel; cut in half and remove cores. See Fig. 2 for appearance of peeling and coring knives.

3. Grade into three grades. If pears are held very long after peeling, cover with water to prevent darkening.

4. Add  $\frac{1}{2}$  pound of sugar to each pound of best grade; and about  $\frac{1}{4}$  pound to each pound of second grade, and only water to pie grade. Add water to cover to all grades to prevent scorching. Pears will require more water than peaches or apricots. Boil 2 to 3 min. and pack hot. Seal solder top and sanitary cans.

5. Sterilize No. 2 $\frac{1}{2}$  and No. 3 cans 20 min; No. 8 and No. 10 cans 30 to 35 min; and jars 25 min. in boiling water. Cool cans in water and seal jars after sterilizing.

6. *Alternative Methods.*

#### Alternative Method A

Prepare a 40% sirup and a 20% sirup; 5 $\frac{3}{4}$  and 2 pounds sugar per gallon respectively. Pack uncooked fruit, peeled in cans and jars. Add boiling hot 40% sirup to best grade; 20% to second grade, and water to pie grade. Seal cans. Sterilize as above but add 5 min. time of cooking in each case. Pears do not shrink very much in canning and therefore this method is well suited to them.

#### Alternative Method B. Use of Fruit Juices

Fruit juices may be substituted for sugar sirups if method B of Recipe 2 is used.

#### (6) Canning of Cherries.

Cherries for canning should be of the sweet varieties and thoroughly ripe.

1. Stem and grade into three grades.
2. Pit with small kitchen size pitter, if desired. Un-

pitted canned cherries develop a slight pit flavor that many prefer to the flavor of the pitted fruit.

3. To best grade add  $\frac{1}{2}$  pound of sugar per pound of fruit; to second grade  $\frac{1}{4}$  pound. Add water to cover. Add only water to pie fruit. Heat very slowly to boiling. Pack boiling hot in cans or jars.

4. Sterilize as directed for apricots and for same lengths of time. (See Recipe 3.)

#### **(7) Canning of Apples.**

Apples are usually canned for pie making, and for this purpose sugar is ordinarily omitted. Use ripe, sound fruit.

1. Peel and core the apples and cut into quarters. Grading is not necessary. (See Fig. 4 for small peeling and coring machine.)

2. Add a small amount of water to apples in pot. Heat to boiling. Pack boiling hot into cans or jars.

3. Sterilize No. 2 $\frac{1}{2}$  or No. 3 cans, and wax top cans 10 min.; No. 8 and No. 10 cans 15 min. and jars 15 min. in washboiler or similar sterilizer, counting time after water boils.

4. Sugar may be added in "2" at rate of  $\frac{1}{2}$  pound of sugar per pound of fruit, if desired.

#### **(8) Canning of Plums.**

Plums tend to break up badly during cooking and sterilization because the fruit is soft when ripe. The white egg plum is popular for canning purposes.

1. Remove stems and grade fruit into three grades. To each pound of best grade add one pound of sugar; to second grade  $\frac{1}{2}$  pound. Add a little water to all three grades. Heat to boiling and boil 2 or 3 min. Pack hot into jars or cans.

2. Sterilize for same lengths of time as directed for apricots. (See Recipe 3, 5.)

3. Alternative Methods. Plums may also be canned by the methods given in Recipe 2.

**(9) Canning of Rhubarb.**

Rhubarb, although a vegetable, resembles the sour fruits in composition. It is canned as a fruit rather than as a vegetable. It cooks down badly during sterilization; it is therefore advisable to cook it before canning. Plain tin cans cannot be used because of the high acidity of the rhubarb. Enamel lined cans or glass jars must be employed.

1. Wash the rhubarb and cut into lengths 1 to 2 inches long and place in a pot. If for sauce, add 1 pound of sugar to each pound of rhubarb with a little water; if for pie stock, only, add a little water. Bring to boil. Boil 3 to 4 min. and pack hot into jars or cans. Use enamel lined cans; plain tin will corrode.

2. Sterilize in a washboiler or other sterilizer in boiling water; No. 2½ or No. 3 cans 10 min. and jars 15 min.

**(10) Canning of Rhubarb without Sterilization.**

1. Choose clean sound stalks. Cut in lengths to fit the jars used. Wash the rhubarb thoroughly and scald the jars and caps.

2. Pack the rhubarb into the jars and fill jars to overflowing with cold water. Seal tightly and store in a cool place.

Rhubarb because of its extreme acidity will keep several months to a year put up in this way.

**(11) Canning of Figs.**

Figs are canned as preserves. White figs are preferred to black. Pick the figs firm ripe but not too soft. Handle carefully.

1. To each pound of figs in a pot add 1 pound of sugar and 2 pints of water. Cook very slowly down to a heavy preserve or until the sirup boils at 220° F., or until the hot sirup tests 28° Baumé or to 60° Balling. This will take at least one hour. The figs should hold their shape. Some varieties of figs will show shriveling during cooking unless the fruit is pierced in a number of places with a



tooth pick or large needle or table fork, so that the sirup will penetrate. The figs will usually be more plump if punctured in this way before cooking.

2. Pack the boiling hot figs and sirup into cans or jars. Sterilize cans 15 min. and jars 20 min. at the temperature of boiling water as directed for peaches and other fruits.

3. *Figs in Water or Light Sirup.* During the rush of the season, it may be inconvenient to make the figs into preserves. If so, they may be canned in water or a 25% sirup. Pack the fresh figs into cans or jars. Cover with a hot 25% sirup (1 cup sugar to 3 cups water or  $2\frac{3}{4}$  pounds per gallon), or with water. Seal cans except wax top cans. Place covers and rubbers on jars and wax top cans loosely. Sterilize  $1\frac{1}{4}$  hours in boiling water. Figs are very difficult to sterilize under these conditions and require at least one hour at  $212^{\circ}$  F. Later these jars or cans may be opened and the figs cooked down to a preserve with sugar. The Kadota, Brown Turkey, and White Endich are the best of California grown figs for canning. The Adriatic is fairly satisfactory. The Smyrna breaks up badly and the Mission is dark colored. The Magnolia is used in Texas for canning. The Celeste fig is excellent.

### **(12) Canning of Strawberries.**

Strawberries are usually preserved in a heavy sirup; but are also canned more or less extensively in medium sirup. Strawberries shrink badly during sterilization. Therefore, they should be cooked before canning. Use sound, ripe, well colored fruit.

1. Wash, sort, and stem.

2. Place the fruit in a kettle and add an equal amount of sugar by weight. Heat slowly to boiling. Boil slowly about 5 min. Allow to stand in the pot over night. This allows the sirup to penetrate.

3. Pack into cans or jars. Heat solder top and sanitary cans in boiling water 3 to 5 min. before sealing.

4. Sterilize cans 10 min. and jars 15 min. in boiling water.

**(13) Canning of Blackberries.**

1. Sort into two grades: one Fancy and the other Pie Grade.

2. To the better grade, add an equal weight of sugar. Cook slowly until the sugar dissolves. Pack into cans or jars. To pie grade add very small amount of water and heat to boiling. Pack hot. Use enamel lined cans and glass jars only.

3. Sterilize cans 10 min. at the boiling point of water and jars 15 min.

*4. Alternative Methods.*

Alternative Method A

In this method pack the berries into cans or jars before cooking. Add hot 50% sirup (1 pound sugar to 1 pint of water), to better grade and water to pie grade. Sterilize 20 min. at temperature of boiling water. Blackberries canned in this way will shrink badly in volume after canning.

Alternative Method B

The berries may also be canned as directed in Method B, Recipe 2.

**(14) Canning of Raspberries and Loganberries.**

These berries may be canned as directed for blackberries. (see Recipe 13.)

**(15) Canning of Oranges.**

Oranges must be sterilized below the boiling point of water; not above 180° F. The fruit must be very ripe or almost overripe in order that it will not turn bitter in the can. A thermometer is necessary.

1. Peel and cut in slices about  $\frac{1}{2}$  inch thick. Pack into enamel lined cans or glass jars.

2. Prepare a 50% sirup (1 pound sugar to 1 pint of water). Heat the sirup to 150° F. and fill the cans or jars. Seal the jars and cans tightly.

3. Place in a large pot or boiler of water at about 120° F. The pot or boiler should contain a false bottom of wire screen or wooden slats to protect the jars from the direct heat of the fire. The jars and cans must be completely immersed.

4. Heat the water slowly to 175° F. Keep it at this temperature for 45 min. Keep thermometer inserted in the water and watch the temperature carefully; it should not exceed 180° F.

Canned oranges do not retain their flavor for any great length of time, usually not longer than three months. After that time they become "stale" in flavor but are still edible.

#### **(16) Canning of Grape Fruit.**

Grape fruit after sterilization in cans or jars is very satisfactory as a base for fruit cocktails, "before breakfast dishes," etc.

1. Peel and cut fruit in small pieces about  $\frac{1}{2}$  inch square or of proper size for fruit cocktails, etc. Pack into jars; if not in jars, in enamel lined cans. Plain tin corrodes and cannot be used. Fill the jars or cans with fresh grape fruit juice which has been heated to 150° to 160° F. Use a thermometer.

2. Sterilize as directed for oranges for 30 min. at 175° F. (See Recipe 15.)

#### **(17) Canning of Grapes.**

The Muscat is the most popular grape for canning. Use large, thoroughly ripe fruit. They are used largely for pies. Other varieties may be used.

1. Wash and remove from stems. Cut the grapes in half and remove seeds if a high quality product is desired.

2. Pack in cans or jars without previous heating. To

fruit for dessert purposes add a hot 40% sirup, and to pie fruit, hot water.

3. Sterilize in a washboiler or other sterilizer at 212° F.; cans 10 min.; jars 20 min. Grapes may also be canned without removing seeds, but the quality of the finished product is much better if seeds are removed.

### **(18) Canning of Pineapples.**

Pineapples are extensively grown for canning in the Hawaiian Islands. Only fruit thoroughly ripened in the field is used.

The fruit is first topped and butted by machinery. It is next peeled or cut to the diameter of a No. 2½ can and the core is removed in the same machine. The fruit is then sliced. It is packed in cans, several grades being made according to appearance of slices. A 50% (1 pound of sugar to 1 pint of water), sirup is added to the best grade. The poorest grade is shredded and canned in a light sirup. The cans are sterilized 35 to 40 min. at 212° F.

Canned pineapple may be purchased more cheaply than fresh pineapple and unless there is a supply of home grown material, it will not pay to can.

### **(19) Canning of Currants, Cranberries, and Gooseberries.**

These fruits may be put up in jars for use in jams, jellies, and pies. Do not use tin because of the high acidity of the fruit.

1. Wash and pack in jars uncooked.

2. Add water hot and sterilize with caps on jars loosely 10 min. in a washboiler or similar sterilizer, counting the time from the time the water boils. Remove jars and tighten caps.

## CHAPTER XX

### CANNING VEGETABLES

The general principles of vegetable canning will be found in Part II, Chap. IV. The following recipes consist of working directions only; it is therefore advised that Chap. IV be read before the actual canning be undertaken.

#### (20) Canning of Artichokes.

Use only young, tender artichokes.

1. Trim off hard tips and stems and outer leaves, leaving only the tender parts.

2. Parboil or blanch in boiling water for 5 to 10 min. This is best done by placing the vegetables in a wire basket or cheesecloth and immersing in the boiling water. Chill slightly in cold water. Pack into jars or cans whole if possible. Cut to fit can if necessary.

3. Fill with boiling hot brine of 3 ounces of salt per gallon and 4 fluid ounces ( $\frac{1}{4}$  pint), of lemon juice or very strong vinegar per gallon. A measuring cup or tablespoon may be used to measure the lemon juice. Two tablespoons equal one ounce of liquid.

4. Sterilize cans, after sealing, one hour in boiling water and jars one and one-half hours. If the jar rubbers swell and become loose, they may be placed on the jars after an hour's sterilization; this subjects them to only a half hour's sterilization.

5. *Pressure Method.* Lemon juice may be omitted in the above formula, but if this is done the vegetables must be sterilized in sealed cans in a steam pressure sterilizer at ten pounds' pressure for 20 min. See par. 21,

Chap. IV. Do not attempt to use jars in a steam pressure sterilizer. The breakage will be too great.

6. *Three-Day Method.* In this method omit the lemon juice but sterilize one hour on each of three successive days in boiling water. (See par. 21, Chap. IV.)

7. *One-Day Method at 212° F.* If the lemon juice and vinegar are omitted, sterilize cans for 4 hours at 212° F. and jars 4½ hours. (See par. 24, Chap. IV.)

### (21) Canning of Asparagus.

1. Use tender tips freshly cut from the garden or field. Freshness is essential.

2. Wash. Grade into three sizes. Cut to length of jar or can.

3. Parboil or blanch in boiling water 2 to 10 min. depending on size of stalks. (See Recipe 1.)

4. Chill in cold water. Scrape skin from very large stalks.

5. Pack into cans or jars neatly with blossom ends up. Square cans are most commonly used.

6. Fill with boiling hot brine of 3 ounces salt (3 tablespoonfuls), and 5 ounces (10 tablespoonfuls), lemon juice or strong vinegar per gallon of water.

7. Seal cans. Place scalded rubbers and caps loosely on jars.

8. Sterilize cans in boiling water one hour and jars one and one-half hours.

9. *Pressure Method.* Omit lemon juice and vinegar. Sterilize in cans 20 min. at ten pounds pressure 240° F. Do not use jars in this method.

10. *Three-Day Method.* Sterilize in boiling water one hour on each of three successive days. (See par. 24, Chap. IV.) Do not use lemon juice or vinegar.

11. *One-Day Method at 212° F.* If the lemon juice and vinegar are omitted from above brine and steam pressure is not used the asparagus may be sterilized by heating

cans or jars in boiling water for 5 hours. Less time than this may result in fatal poisoning.

**(22) Canning of Green String Beans and Wax Beans.**

1. Use small tender pods only for the best results. Grade into two sizes. The smaller grade will be most tender.

2. String and break or cut into pieces as for table use. Large pods are greatly improved by cutting into thin pieces lengthwise.

3. Parboil or blanch in boiling water; the small tender pods 3 min. and larger, tougher pods 6 min. or longer. Par boiling is easily done by placing the beans in a cheese-cloth bag and immersing in boiling water. Chill momentarily in cold water. (See par. 17, Chap. IV.)

4. Pack into cans or jars. Add a boiling hot brine of 2 oz. (2 tablespoonfuls), salt and 4 fluid oz. (8 tablespoonfuls), lemon juice per gallon of water. Seal cans. Place caps and rubbers on jars loosely.

5. Sterilize cans  $1\frac{1}{2}$  hours in boiling water; jars 2 hours at the same temperature. (See par. 21, Chap. IV.) Remove jars and seal.

6. *Pressure Method.* Omit lemon juice and vinegar in above formula. Sterilize in cans, only 30 min. under 10 lb. steam pressure,  $240^{\circ}$  F.

7. *Three-Day Method.* Omit lemon juice and vinegar from brine. Sterilize in boiling water 1 hour on each of three successive days. (See par. 21, Chap. IV.)

**(23) Canning of Beets.**

1. Use small red beets of good color. Turnip shaped beets are preferred. Wash, cut off tops and roots.

2. Parboil until the skins will slip easily. This will be 10 to 15 min. boiling.

3. Chill in cold water and peel.

4. Pack into jars or cans. Add a boiling hot brine of 3 oz. (3 tablespoonfuls) salt and 4 fluid oz. (8 table-

spoonfuls), lemon juice or strong vinegar per gal. Seal cans and place caps on jars loosely.

5. Sterilize cans 1 hour in boiling water and jars  $1\frac{1}{2}$  hours.

6. *Pressure Method.* Omit lemon juice and vinegar in above recipe. Sterilize cans 30 min. at 10 lbs. pressure,  $240^{\circ}$  F.

7. *Three-Day Method.* Omit lemon juice and vinegar. Sterilize 1 hour in boiling water on each of three successive days.

8. *One-Day Method at  $212^{\circ}$  F.* If the lemon juice or vinegar are omitted from the brine, sterilize cans  $4\frac{1}{2}$  hours and jars 5 hours at  $212^{\circ}$  for one day only.

#### (24) Canning of Carrots, Turnips, Parsnips and Onions.

1. Peel and cut in pieces as for table use.

2. Place in cans or jars. Add a hot brine of 4 fluid oz. of lemon juice or strong vinegar (8 tablespoonfuls), and 3 oz. by weight (3 tablespoonfuls), salt per gallon of water. Seal cans. Leave caps and rubbers on jars loosely.

3. Sterilize cans  $1\frac{1}{2}$  hours in boiling water and jars 2 hours.

4. *Pressure Method.* As for beets (See Recipe 23, 6.)

5. *Three-Day Method.* As for beets. (See Recipe 23, 7.)

6. *One-Day Method at  $212^{\circ}$  F.* If lemon juice or vinegar are omitted from brine, follow one-day method as for beets. (See Recipe 23, 8.)

#### (25) Canning of Corn.

1. Use sweet corn at the best stage of ripeness for table use. Can immediately after gathering from garden or field. Remove husks and silk. Blanch in boiling water 10 min. and chill.

2. Cut the corn from the cob avoiding the hard husks of kernels near cob; that is, do not cut too close to the cob. Scrape cobs.



3. Prepare a brine of  $\frac{1}{2}$  lb. sugar, 3 oz. (3 tablespoonfuls) salt and 6 fluid oz. (12 tablespoonfuls), lemon juice or strong vinegar per gallon of water.

4. Place the corn in a pot and add enough of the brine to practically cover the corn. Heat to boiling. Boil about 5 min. Transfer while boiling hot to cans or jars. Seal cans and place caps and rubbers on jars loosely.

5. Sterilize cans 2 hours and jars  $2\frac{1}{2}$  hours in boiling water by wash boiler or similar sterilizer.

6. *Pressure Method.* Omit lemon juice and vinegar from the above recipe. Sterilize in cans for 50 min. under 15 lbs. pressure,  $250^{\circ}$  F. No. 2 cans are usually employed for corn. Do not use glass jars in the pressure method for corn.

7. *Three-Day Method.* Omit the lemon juice and vinegar from the above recipe. Sterilize cans or jars for  $1\frac{1}{2}$  hours at  $212^{\circ}$  on each of three successive days. Corn is hard to sterilize because the heat penetrates slowly and because the corn is lacking in acid and contains spore-bearing, heat-resistant bacteria.

8. *One-Day Method at  $212^{\circ}$  F.* If the lemon juice and vinegar are omitted from brine, sterilize both cans and jars 6 hours at  $212^{\circ}$  F.

### **(26) Canning of Green Peas.**

Peas are harvested, shelled, cleaned, and graded commercially by machinery. If all of these operations are carried out by hand the product becomes too expensive for marketing purposes. Enough for canning for home use may be shelled by hand.

1. Select tender peas. Shell.

2. Place in a cheesecloth bag or wire basket and par-boil or blanch in boiling water 1 to 5 min. depending on the size and texture. Chill in cold water.

3. Pack into jars or cans.

4. Fill with a boiling hot brine of 2 oz. of salt (2 tablespoonfuls), and 5 fluid oz. (10 tablespoonfuls), lemon

juice or strong vinegar per gallon of water. Seal cans. Place caps and rubbers on jars loosely.

5. Sterilize cans  $1\frac{1}{2}$  hours and jars 2 hours at  $212^{\circ}$  F. In cooking peas canned in this way after opening the can add a little baking soda to remove the lemon flavor.

6. *Pressure Method.* As for beets. (See Recipe 23, 6.)

7. *Three-Day Method.* As for beets. (See Recipe 23, 7.)

8. *One-Day Method at  $212^{\circ}$  without Lemon Juice or Vinegar.* Sterilize cans at  $212^{\circ}$  F.  $5\frac{1}{2}$  hours and jars 6 hours if lemon juice or vinegar are omitted from brine.

### (27) Canning of Pimentos and Sweet Peppers.

1. Select ripe, well colored pimentos or sweet peppers. To peel them place them in a very hot oven for a short time, until the skins may be easily slipped from the pimentos with the fingers. They may also be peeled by dipping them in very hot cotton seed oil for a short time.

2. Allow to cool. Remove skins and cut out stems and seed cores.

3. The heating will have softened them. Pack well in cans or jars. Fill with boiling hot water. Seal cans. Place rubbers and caps loosely on jars.

4. Sterilize cans 40 min. and jars 60 min. at  $212^{\circ}$  F. in a washboiler sterilizer. Pressure sterilization and lemon juice are not necessary.

### (28) Canning of Pumpkin and Squash.

1. Cut in half and remove pulp and seeds. Cut in strips and cut off outer rind. Cut flesh in pieces that will go into cans or jars conveniently.

2. Pack into jars or cans. Add a boiling hot brine of 2 oz. of salt (2 tablespoonfuls), and 4 fluid oz. lemon juice (8 tablespoonfuls), per gallon. Seal cans; place lids and rubbers on jars loosely.

3. Sterilize cans 1 hour and jars  $1\frac{1}{2}$  hours at  $212^{\circ}$  F. In using pumpkin canned in this way it will be advisable

to add a little baking soda to remove the acid taste after can is opened for use.

4. *Pressure Method.* Remove pulp and outer rind. Cook till soft. Pass through screen or grinder. Heat pulp almost to boiling. Pack into cans hot and seal. Sterilize 1 hour at 10 lbs. steam pressure. Do not use jars.

5. *Three-Day Method.* Prepare and can as in (4) but sterilize cans  $1\frac{1}{2}$  hours and jars 2 hours on each of three successive days.

### (29) Canning of Spinach and Other Greens.

1. Greens for canning should be fresh. Trim as for cooking for table use.

2. Place in wire basket or cheese cloth and immerse in boiling water for 10 min. Chill in cold water.

3. Pack in jars or cans.

4. Fill with boiling hot brine of 2 oz. salt (2 tablespoonfuls) and 6 oz. (12 tablespoonfuls) lemon juice per gallon of water. Seal cans. Place caps and rubbers on jars loosely.

5. Sterilize cans in boiling water 60 min. and jars 80 min.

6. *Pressure Method.* As for beets. (See Recipe 23, 6.)

7. *Three-Day Method.* As for beets. (See Recipe 23, 7.)

8. *One-Day Method at 212° F.* Sterilize cans 4 hours and jars  $4\frac{1}{2}$  hours at 212° F. if lemon juice and vinegar are omitted from brine.

### (30) Canning of Tomatoes.

Tomatoes for canning should be smooth skinned and of good color.

1. To peel the tomatoes, place them in a wire basket or cheesecloth and immerse in boiling water long enough to crack and loosen the skins. This will be  $\frac{1}{2}$  to 1 min.

2. Chill in cold water and peel. Cut out cores. The juice from the cores may be added in canning.

3. Heat to boiling and pack hot in cans or jars. Seal cans. Place caps and rubbers on jars loosely.

4. Sterilize No. 3 cans in boiling water 40 min. and No. 10 cans 75 min.; jars 60 min. Tomatoes canned without the addition of tomato juice are known as "solid pack"; if juice is added, "standard pack."

5. *Canning Whole Tomatoes for Use in Salads.* Peel as in "1." Do not remove cores. Pack carefully whole in wide mouthed cans or jars. Prepare tomato juice by pressing cooked tomatoes through a cheesecloth. Heat juice to boiling. Pour boiling hot on the tomatoes in the cans or jars. Seal cans. Sterilize 5 min. in boiling water counting time from time the water boils.

6. *Canning Tomato Purée.* Tomato purée is the pulp of the tomato minus skins and seeds. Peel as in "1." Boil in pot till soft. Pass through fine screen to remove seeds. Heat to boiling. Fill into jars or cans. Seal cans. Space is saved if the purée is boiled down to one-half its volume before canning. Sterilize No. 3 cans or smaller cans at 212° for 80 min. and jars 1½ hours, and No. 10 cans 1¼ hours. Purée is useful for soups, etc. Commercially, tomato purée is made in enormous quantities for ketchup manufacture. A special machine known as the "cyclone" removes skins and seeds and makes a coarse pulp. The pulp is passed through a finisher to break it up more finely before boiling down and canning.

### (31) Canning of Sweet Potatoes.

Sweet potatoes are best sterilized without pressure. The cans must be well filled or oxidation and darkening of color will result.

1. Use freshly dug potatoes.

2. Boil in water until the skin will slip easily from the potato, usually 15 to 20 min. Peel while still as hot as possible. Gloves may be worn to protect the hands.

3. Pack tightly into cans or jars pressing the potatoes

down to make the container as full as possible. Seal cans. Place caps and rubbers on jars loosely. The best grade of rubbers must be used.

4. Sterilize No. 2 and No. 3 cans 4 hours in boiling water and jars 5 hours. Pressure sterilization results in darkening and the lemon juice method is not suitable.

### (32) Canning of Dried Beans.

1. *Beans Boston Style.* Soak the beans overnight in water. Discard the water. Place the beans in a screen basket or mosquito netting bag and steam in a covered washboiler or steam pressure retort for  $1\frac{1}{2}$  hours. Prepare a sauce as follows: Boil together 2 gals. water; 5 oz. (10 tablespoonfuls) salt; 1 pint best molasses; 2 lbs. sugar; allow to cool to about  $160^{\circ}$  F. and add  $\frac{1}{4}$  lb. of butter; 1 tablespoon ground cinnamon;  $\frac{3}{4}$  teaspoon of cayenne pepper and  $1\frac{1}{2}$  gals. of tomato purée (tomato pulp). Pack the hot steamed beans into cans filling cans about  $\frac{1}{2}$  inch from top. Heat the sauce prepared as above to boiling and fill the cans. Seal. Sterilize  $1\frac{1}{4}$  hours at 15 lbs. steam pressure or  $250^{\circ}$  F. They may also be sterilized by heating to  $212^{\circ}$  F. for  $1\frac{1}{2}$  hours on each of three successive days.

2. *Beans with Pork.* Proceed as in "1" but when beans are filled into cans add a few strips of salt pork to each can. Sterilize as in "1."

### (33) Canning of Hominy.<sup>1</sup>

1. *Preparation.* Dissolve 2 oz. soda lye (2 tablespoonfuls, level), in each gallon of water in an agateware pot. Place white dry corn in this and boil hard for 1 hour. Place the corn in a wire basket or mosquito netting bag and allow cold water to run through it for 5 or 6 hours. If this cannot be done, place in a large tub of water and change the water often and stir frequently for 6 or 8 hours. This is to remove the lye. Place the corn in a hulling machine to remove the hulls and black eyes.

<sup>1</sup> From "National Canning Recipes," page 26.

This machine may be made by running a shaft through a barrel lengthwise. Place the ends of the shaft on a horizontal support so that the barrel may be revolved.

A barrel churn may also be used for this. After hulls and eyes are removed, place the hulled corn back in the agateware kettle with water and cook until tender. Place on coarse screen and wash out remaining hulls and eyes with water.

2. *Sterilizing.* Fill into cans. Add a boiling hot brine of 2 oz. (2 tablespoonfuls), of salt per gallon of water. Cap and seal. Sterilize cans 45 min. at 15 lbs. steam pressure, 250° F. or 1¼ hours on each of three successive days at 212° F. Jars may be used if sterilized 1½ hours on each of three successive days at 212° F.

#### (34) Canning of Egg Plant.

1. Peel and cut in slices. Drop in boiling water for 10 to 15 min.

2. Pack hot in cans or jars. Cover with boiling water. Seal cans. Place scalded caps and rubbers on jars without screwing them down.

3. *Pressure Sterilization.* Sterilize cans 60 min. at 10 lbs. pressure, 240° F.

4. *Three-Day Method.* Sterilize jars or cans 1 hour on each of three successive days at 212°F.

5. *One-Day Method at 212°.* Sterilize at 212° F. for 3½ hours in jars or cans for one cooking only.

#### (35) Canning of Okra.

1. Wash the okra in cold water. Parboil 15 min. in boiling water.

2. Cut off and discard stem end. Cut in slices crosswise. Pack in cans or jars.

3. Fill cans or jars with hot brine, consisting of 2 oz. (2 tablespoonfuls), of salt and 4 oz. of lemon juice or strong vinegar per gallon of water. Seal cans. Leave lids and rubbers loose on jars.

4. Sterilize cans 1 hour at 212° F. and jars 1½ hours. Count time after water boils.

5. *Pressure Sterilization.* Omit lemon juice and vinegar from above brine. Sterilize in cans 30 min. at 10 lbs. pressure 240° F.

6. *Three-Day Method.* Omit lemon juice and vinegar. Sterilize 1 hour on each of three successive days at 212° F.

7. *One-Day Method at 212° F.* Omit lemon juice and vinegar. Sterilize cans 2 hours and jars 3½ hours at 212° F.

## CHAPTER XXI

### CANNING MEATS

Meats are very difficult to sterilize because of their lack of acid and because of the presence of spore-bearing bacteria. Unless thoroughly sterilized, there is danger of ptomaine and *botulinus* poisoning. The following directions give good results if carefully followed.

#### (36) Canning Meats without Preliminary Cooking.

1. Cut the fresh meat in pieces to fit cans or jars. Pack into jars or cans.

2. Prepare a broth by boiling the bones or scraps or other meat in water. Season to taste with salt. Pour this boiling hot into the cans or jars. Seal cans.

3. *Sterilization by Three-Day Method.* Sterilize at 212° F. 1½ hours on three successive days.

4. *One-Day Method.* Sterilize at 212° F. for 6 hours on one day only. This method is used extensively by California housewives and was first advocated by Miss Lillian D. Clark of the University of California.

5. *Pressure Method.* Sterilize in cans 30 min. at 15 lbs. steam pressure 250°.

6. *Acidified Brine Method.* Prepare a brine of 3 oz. salt per gallon or use a meat broth and acidify the brine or broth with 4 oz. (8 tablespoonfuls), lemon juice or strong vinegar per gallon. Pack the meat into cans or jars. Fill with boiling hot acidified liquid and sterilize 4 hours at 212° F.

#### (37) Canning of Cooked Meats.

1. Cook the meat in any desired way as for use on the table. For example, chicken and rabbit may be fried after rolling the fresh meat in flour; or they may be



boiled in lightly salted water until almost done. Beef and pork may be roasted or stewed, etc., before canning.

2. Pack the cooked meat while hot in cans. Fill with boiling hot gravy, or tomato sauce, or broth. A gelatin broth made by boiling unflavored gelatin in meat broth or water is often added. This sets to a jelly in the jar or can after sterilization. Knox's or other unflavored gelatin may be used. Two or three ripe olives added to each jar or can will greatly improve the flavor.

3. Sterilize as in Recipe 36.

4. *Acidified Brine Method.* To the gravy or brown liquid or broth from cooking add 1 oz. (2 tablespoonfuls) lemon juice or strong vinegar per quart and mix well. Pack meat in jars or cans. Add boiling hot liquid and sterilize 4 hours at 212° F.

### **(38) Canning of Corned Beef.<sup>1</sup>**

1. Prepare the beef by the corning process as described in Recipe 127.

2. Place the beef in an ordinary kettle; cover with cold water; bring slowly to a boil for an hour.

3. Cut into pieces of proper size to fit the openings of the cans or jars. Pack and cover with a hot liquid made by adding gelatin to the liquid in which the meat was boiled, flavored with laurel (bay leaves), cloves and nutmeg to taste.

4. Sterilize by any of the methods give in Recipe 36.

### **(39) Canning of Fresh Fish.**

1. Prepare as for cooking for the table. Cut the fresh fish to fit cans or jars and pack tightly.

2. Fill the cans or jars with a boiling hot weak brine or with a highly spiced tomato purée or catchup.

3. Sterilize by any of the methods given in Recipe 36.

4. *Sardines.* Sardines are cooked in hot cottonseed or olive oil and packed in oil. Sterilize for one-half the time given in 36.

<sup>1</sup> "National Canning Recipes," page 55.

5. *Salmon.* Salmon may be canned as described in (1), (2), and (3) but usually the fresh fish is packed tightly into cans and no liquid is added. The cans are heated in steam for an hour before sealing. The cans are then sealed and sterilized at 15 lbs. pressure 250° F. for 1½ hours or for 5 hours at 212° F.

6. *By Acidified Brine.* Pack the fresh fish into cans rather loosely. Prepare a brine of 3 oz. salt (3 tablespoonfuls), and 5 oz. (10 tablespoonfuls) lemon juice per gallon. Heat to boiling and fill jars or cans. Sterilize at 212° F. for 4 hours and seal. Instead of brine, tomato purée may be added.

**(40) Canning of Kippered Fish.**

1. Soak the fresh fish in a strong brine (2 lbs. per gallon), overnight. Smoke with spent tan bark smoke or smoke from hard wood as described in Recipe 136 for about 8 hours.

2. Pack into cans and fill with hot water. Sterilize as described in Recipe 36.

Small fish such as herring, smelt, sardines, etc., are excellent prepared in this way.

## CHAPTER XXII

### RECIPES FOR FRUIT JUICES

The most important step in the preparation of fruit juices is the sterilization of the juice. Temperatures should be used which will sterilize the juices without imparting a cooked taste. The recipes include directions for the preparation of the fruit juices that have been found by experience to be satisfactory beverages. Certain fruits such as peaches, apricots, and prunes, do not give satisfactory juices and are therefore omitted.

#### (41) Apple Juice.

Apples for the production of juice should possess a marked flavor. Winesap, Northern Spy, Gravenstein, Newtown Pippin, are all good for this purpose. Use clean, sound fruit and not wormy culls. A thermometer that may be immersed in the juice or water will be necessary. A dairy thermometer reading to 185° F. or higher will answer the purpose. See Chap. VII for description of crushers and presses.

1. Crush or grind the fruit and press out the juice. If the fruit is heated to 150° to 160° F. (not above 160° F.) for a few minutes it will press more easily. Heat the juice to 150° F. in a pot.

2. Strain or filter the juice through a jelly bag or other filtering device. It is usually desirable to strain the juice twice.

3. Fill the juice into bottles, allowing a space of about 1½ inches in the necks of the bottles for expansion of the juice during sterilization. Crown finish bottles are best if any large amount of juice is to be put up.

4. Cork the bottles with corks previously sterilized

for 10 min. in boiling water. Tie the corks down with a string to hold them in the bottles during sterilization. If crown caps and bottles are used, place the caps on the bottles with a crown bottle capping machine. (See Fig. 24.)

5. *Pasteurization.* Lay the bottles in a horizontal position on the false wooden bottom of a washboiler or large pot. Fill the boiler or pot with water. Heat the water slowly until a thermometer held in the water registers 175° F. Maintain this temperature for 20 min. (See Fig. 25.) For larger scale pasteurization a large wooden vat with false bottom and heated with steam coils may be used. The washboiler or other pasteurizer may be filled full of bottles so long as the water completely covers them.

6. *Paraffining the Corks.* As soon as the bottles are removed, dip the ends of necks and corks in melted paraffin. Dip again when the bottles are cold. This prevents molding. Dipping is not necessary for Crown Caps.

7. *Canning Apple Juice.* The strained apple juice may also be pasteurized in cans. Enamel lined cans are safer to use than plain tin lined cans because of the action of the juice on tin. Fill the cans with juice. Seal them. Pasteurize as described above for bottles. Solder top cans previously described, or sanitary cans that may be sealed with a small hand power capping machine may be used.

#### (42) Red Grape Juice.

1. *Varieties of Grapes.* Red grape juice should have a pleasing and pronounced flavor in addition to a deep red color and tart taste. Practically none of the European varieties of red grapes grown in the United States possess all of these characteristics. They are, however, found in Eastern varieties. They may also be obtained from European varieties if two varieties of European grapes are mixed or their juices blended.

An excellent combination of European varieties is made of equal quantities of Muscat and any good variety of red wine grape. The Muscat furnishes flavor. Petite Serah, Zinfandel, Carignarne and Mataro or other common variety of red wine grape may be used for color and acid. Better varieties for this purpose are Barbera St. Macaire, and Refosco. The Muscat is a large white raisin and shipping grape of very pronounced flavor. It is grown very extensively in California. The other varieties are red wine grapes grown in California. Any Eastern variety of good color may be used without the addition of red wine grapes. Concord and Isabella are both good varieties.

2. *Picking.* The grapes should not be too ripe. If a Balling sugar tester is available, test the grapes from time to time during ripening. Muscat grapes should be picked at about 22% sugar when tested with the Balling saccharometer; red grapes at 18% to 20%, that is, when they are still quite acid or tart.

3. *Crushing.* Crush thoroughly. This can be done in an agateware pot with a potato masher or with the hands. If Muscats are used, mix with an equal amount of some red wine grape.

4. *Heating to Extract Color.* Heat the crushed grapes with a thermometer inserted until a temperature of 140° F. is reached. Stir the grapes often. Remove the heated grapes from the stove and allow to stand in an agateware or aluminum pot overnight. On a large scale the grapes may be crushed in a hand power grape crusher (see Fig. 22), and heated in a wooden vat by means of a tin steam coil or in a large tin lined or aluminum steam kettle. Both methods are used commercially. The juice may also be heated after pressing from the grapes and then returned hot to the grapes to remove the color.

5. *Pressing.* Press the grapes after they have stood

overnight as directed above. Small quantities may be pressed through a jelly bag or flour sack. A ciderpress (see Fig. 22), may be used for larger quantities.

6. *Filtering.* As directed for apple juice, Recipe 41.

7. *Bottling and Pasteurizing.* As for apple juice. Grape juice may also be pasteurized in cans to good advantage.

#### **(43) Loganberry, Blackberry, and Raspberry Juices.**

1. Use ripe well colored berries. Crush thoroughly.

2. Heat in an agateware or aluminum pot to 150° to 160° F. with a thermometer inserted.

3. Press hot through a bag or press. Strain several times until fairly clear.

4. To each gallon of loganberry or blackberry juice, add 2 lbs. of sugar. To each gallon of raspberry juice, add 2 lbs. of sugar and 1 pt. of lemon juice.

5. Bottle, and pasteurize as for apple juice.

6. The juice is diluted with from one to two cups of water to each cup of juice before serving. Loganberry juice has become one of the most popular fruit juice beverages of the United States.

#### **(44) Lemon Juice.**

Lemon juice does not retain its flavor well after pasteurizing. Cull lemons and "juice" lemons may often be obtained from lemon orchards or packing houses very cheaply.

1. Cut the lemons in half. Remove the pulp and juice in a lemon squeezer or on a glass lemon cone. Strain out coarse pulp.

2. Bottle and pasteurize as directed for apple juice. (Recipe 41.)

Lemon juice develops a "limey" or "stale" flavor in time but is still good for lemonade.

#### **(45) Orange Juice.**

1. Use ripe fruit. Fruit at the beginning of the season will make a bitter juice.

2. Peel the fruit to remove oil cells. Crush and press out juice. Or cut the whole oranges in half and remove pulp and juice on an orange cone.

3. Strain through a cheesecloth. Do not remove all the pulp by straining because it contains the flavor. Do not allow oil from the skins to get into the juice because this in time becomes stale in flavor.

4. Bottle and pasteurize as for apple juice. (See Recipe 41.)

Orange juice retains its flavor only a short time, not more than two or three months and is not very satisfactory as a bottled juice.

#### **(46) Orange-Lemon Juice.**

1. Mix 1 pint of lemon juice with each gallon of orange juice. Add 2 lbs. of sugar to each gallon.

2. Bottle and pasteurize as directed for apple juice. (Recipe 41.) To serve this juice, dilute each cup of juice with 1 or 2 cupfuls of water.

This juice retains its flavor much better than ordinary orange juice.

#### **(47) Grape Fruit Juice.**

1. Cut the fruit in half and remove pulp and juice on a glass cone.

2. Strain through cheesecloth.

3. Heat in an agateware pot to 175° F. and fill into scalded bottles, filling them full.

4. Cork and tie down the corks.

5. Place bottles in water previously heated to 175° F. and keep at 175° F. for 20 min.

6. Remove bottles and seal with paraffin. This method removes the air from the bottles and prevents darkening of the juice, which would otherwise take place.

Grape fruit juice is the most satisfactory of all citrus fruit juices. A great deal of this is now bottled in Florida for sale.

**(48) Pomegranate Juice.**

1. Choose well colored ripe fruit. Cut fruit in half and remove kernels. Be careful not to get any of rind or pulp mixed with the kernels.

2. Crush the kernels, press out the juice and heat to 150° F.

3. Allow the juice to stand overnight. Strain until fairly clear.

4. Add 1 lb. of sugar to each gallon of juice.

5. Bottle and pasteurize as directed for apple juice. (See Recipe 41).

**(49) Pineapple Juice.**

1. Use well ripened fruit. Remove butts and rinds. Crush the pulp and press out the juice.

2. Heat the juice to 150° to 160° F. in an agateware or aluminum pot. Allow to stand overnight. Filter.

3. Bottle and pasteurize as directed for apple juice.

**(50) Clarification of Fruit Juices.**

In addition to filtration, fruit juices may be made clear by the addition of various substances which will coagulate and settle, carrying with them to the bottom of the container, the material which causes the cloudiness. Clay, casein, and the white of egg are the most suitable materials for this purpose. Clay and casein are coagulated by the acid of the fruit juice. Egg white must be coagulated by heating the juice.

1. *Clarification with Clay.* Prepare a solution of good grade of clay by soaking 1 lb. of dry clay in each gallon of water. (A clay known as Spanish clay is considered best for this purpose, it being a medium grade of potters' clay.) The clay is soaked for about 10 days and then worked with the hands until it forms a smooth thin mud with the water.

To clarify apple juice with clay, add 1 pint of the thoroughly mixed clay to each 10 pints of juice and heat with stirring to 150° F. Let stand overnight.



The next morning pour off the clear juice and filter the sediment. The juice is then bottled and pasteurized as directed for unclarified juice. If clarification is imperfect, use more clay.

For grape juice, use  $\frac{3}{4}$  pint of the clay to each 10 pints of juice; other juices, 1 pint to 10 of juice and proceed as with apple juice. Occasionally, the juice will not become clear with this amount of clay and more must be added.

2. *Clarification with Casein.* Casein may be bought through a drug store. It comes as a granular powder. To dissolve it, add to each 3 oz. by weight of the casein, 1 tablespoonful of sal soda and 1 pint of water. Boil till dissolved and then add 7 pints of water.

Casein is used for grape juice only. To each 10 gallons of juice, add  $\frac{1}{2}$  gallon of the casein solution. Heat to 150° F.; allow to stand overnight; pour off clear juice and filter the sediment.

3. *Clarification by Combined Use of Casein and Clay.* This combination gives good results with grape juice. Add  $\frac{1}{2}$  gallon of the casein solution and  $\frac{1}{2}$  gallon of the clay solution to each 10 gallons of juice and proceed as in "1."

4. *Clarification with Egg White.* Mix the white of 1 egg with a half pint of water. Add this to each gallon of grape juice. Heat to 175° F. and proceed as above. Egg white gives good results with grape juice but is not satisfactory for most other juices.

## CHAPTER XXIII

### SIRUPS

Sirups for table use and for cooking purposes may be made in the kitchen or in a small way on the farm with the materials found at hand or constructed at small expense. Usually, these home made sirups will not be as light colored as the factory made products but will be of pleasing flavor, if carefully prepared. Grapes and apples are especially well suited to the manufacture of sirups. Sorghum is also excellent. The general principles of sirup manufacture will be found in Chapter VIII.

#### (51) Fruit Sirups for Cooking Purposes.

1. Crush the fruit and press out the juice. Apples and berries may be heated to boiling after crushing to facilitate extraction of the juice.

2. Heat the pressed juice to boiling and filter through a jelly bag or other form of filter until clear. The juice may also be clarified by methods described in Recipe 50. This will give a clearer and more attractive sirup.

3. Boil the juice down rapidly in a shallow pan. Long boiling causes the sirup to be dark colored and of poor flavor. The hot sirup should finally test 63% Balling or 35° Baumé or must be boiled until it becomes of the desired consistency.

4. Pack the sirup boiling hot into scalded jars or bottles and seal at once. Sirup that tests 63° Balling hot or 68° Balling cold will keep without packing hot in scalded jars or bottles. The sugar test is not necessary if the sirup is sealed hot.

Sirups made as above are suitable for use in mince-meat etc., but are somewhat too sour for table use.

Grapes and apples are the most suitable fruits for this purpose.

**(52) Fruit Sirups for Table Use.**

1. Clarify the fruit juice. To do this, heat to boiling and strain till clear or clarify according to Recipe 50.

2. Divide into two lots representing  $\frac{1}{4}$  and  $\frac{3}{4}$  of the juice respectively.

3. To  $\frac{3}{4}$  of the juice add 2 oz. (3 tablespoonfuls) of precipitated chalk per gallon. Heat to boiling and allow to stand overnight. Filter through a jelly bag to remove the chalk. The juice may also be treated with baking soda instead of chalk. Add the soda in small amounts until there is no longer any acid taste. Do not add too much soda.

4. To the filtered juice add the  $\frac{1}{4}$  of untreated juice. Boil the juice down to a sirup and seal boiling hot in bottles or jars. This sirup is less acid than that made by the preceding recipe and can be used on griddle cakes, etc.

Precipitated chalk may be bought from any drug store. Ground limestone may also be used. It is harmless.

**(53) Fruit Sirups by Sun Evaporation.** (See Chap. VIII, par. 35.)

1. Crush the fruit, press out the juice and strain or filter it until clear.

2. Place the juice in a shallow pan or make a shallow wooden water-tight trough. Place whole apparatus in a sunny place. Hang from a clothesline or other support above the container several strips of cheesecloth. (See Fig. 29 for diagram of such an arrangement.) Dip the cloths in the juice and hang them above the pan or trough. In a few minutes the juice will dry to a sirup on the cloth. Dip them in the juice; wring out the sirup into the juice; dip again and hang up to dry. Repeat this until the sirup reaches 65% to 68% Balling or 35% to 37% Baumé. (See Chap. II, par. 11, for use of these testers.) Store in bottles or jars.

This sirup will have a great deal of the fresh fruit flavor and may be diluted as a beverage or may be used in cooking. Sirups for table use may be made in a similar way by modifying Recipe 52 accordingly.

**(54) Fruit Sirups made by the Addition of Sugar.**

Highly flavored and tart juices may often be sweetened with sugar to give heavy sirups suitable for use in soda fountains or as bases for home made beverages.

1. *Lemon, Orange and Grape Fruit Sirups.* Grate off the oil cells from  $\frac{1}{2}$  doz. fruits. To the gratings add  $2\frac{1}{2}$  lbs. of sugar and 1 pint of the juice of the fruit used. Warm until sugar dissolves. Stir and allow to stand with occasional stirring for three or four days. Press through a cloth to remove gratings.

2. Pomegranate, red grape juice, strawberry, loganberry, raspberry, and blackberry juices may be made by adding  $1\frac{3}{4}$  lbs. sugar to each pint of juice. This sirup will keep without sterilization.

**(55) a. Sorghum Sirup. Home Recipe.**

1. Crush the green sugar sorghum canes. A food chopper may be used for small scale work; for larger scale work a cane mill will be needed. The ground cane may be boiled with a small amount of water and pressed a second time.

2. Heat the juice to boiling and strain until clear.

3. Boil down until the sirup will test 63% hot or 68% Balling cold, or until of desired consistency. Seal hot in scalded jars, bottles, or cans.

**(55) b. Manufacture of Sorghum on Small Commercial Scale.**

1. *Equipment.* Small horse power mill (see Fig.); galvanized iron or copper evaporating pan 8 to 10 ft. long (see Fig.); portable furnace for pan; settling pan at crusher about 6 to 8 ft. long to permit settling of juice (this pan may be made of galvanized iron to receive juice at upper end of pan and to allow settled juice to

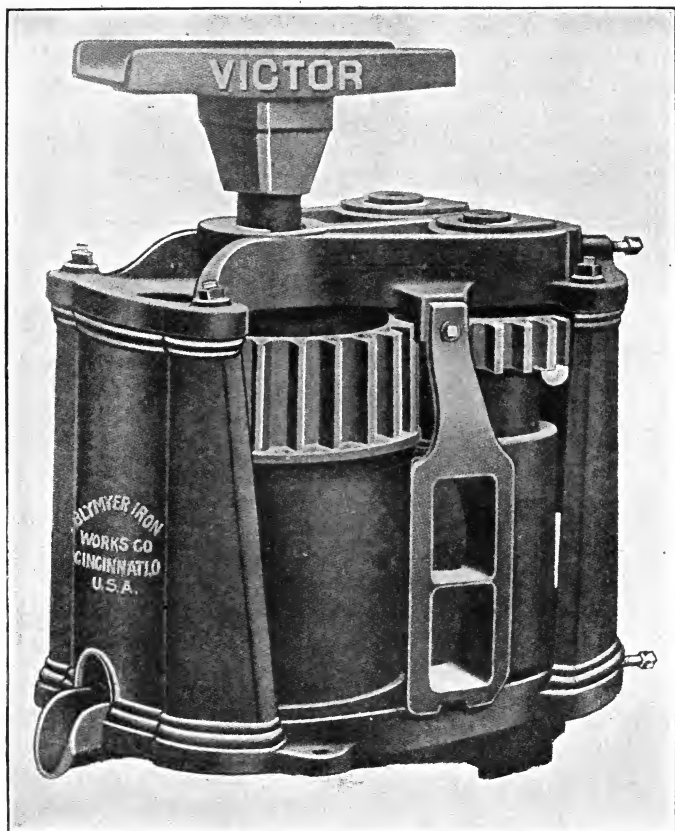

FIG. 58. Horse Power Sorghum or Cane Mill. (Courtesy Blymer Iron Works.)

flow out at lower end into a settling tank); settling tank or barrel of 50 gals. capacity for fresh juice; two open 50 gal. barrels; skimmer for use during boiling of sirup; 10 or 15 gal. open barrels or tubs with spigot, to be placed above and at one end of evaporating pan to supply juice to pan; several buckets and dippers.

2. *Varieties of Sorghum.* Honey Sorghum, Orange Sorghum, Red Amber Sorghum, and Gooseneck Sor-

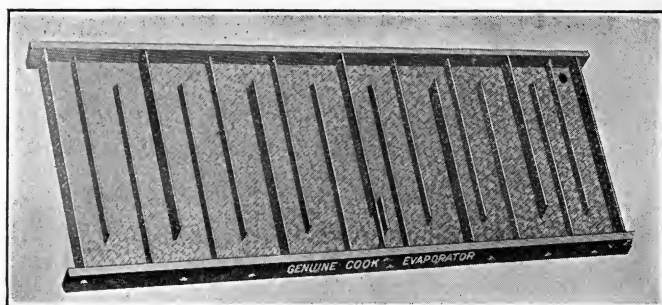

FIG. 59. Evaporating Pan for Sorghum and Other Sirups. (Courtesy Blymer Iron Works.)

ghum are all good varieties. Plant quick maturing varieties in Eastern states and late maturing varieties in California.

3. *Harvesting.* Strip off leaves from canes when seed is almost ripe; cut canes at 6 to 8 inches from ground. Cut off seed heads and haul stripped cane to the mill at once. Leaves and seed heads spoil the flavor of sirup and make it hard to clear, therefore, they should be used for forage only and not for sirup.

4. Press juice from stripped cane by running it through a sorghum mill (see Fig.). The mill is set on supports so that bottom of rollers is about 40 inches from the ground and is operated by a sweep fastened to top of rollers and

drawn by one or two horses. Power mills may be used for larger factories.

5. Allow juice from mill to flow continuously through settling pan and from settling pan into a 50 gal. settling tank.

6. Heat to boiling and allow to settle 4 or 5 hours in settling tank. This can be done by running the juice through the pan at such a rate that it will be heated to boiling but not concentrated to a sirup. Skim off floating material and draw settled juice off from sediment. The settled juice is used for sirup; the sediment may be used for stock feed or strained and used for sirup.

7. Fill the evaporating pan with the juice and boil down to a sirup. Allow sirup to flow from the pan and the juice to flow into the pan at such a rate that the sirup tests when hot, 36° to 40° Baumé or 65° to 73° Balling or Brix. A very hot fire is essential; quick burning wood is best; crude oil can be used if a special burner is installed.

8. Allow sirup to settle 4 or 5 hours in a shallow vessel. Draw it off and fill into sirup cans or kegs.

Sorghum sirup outfits may be obtained from dealers in farm machinery. (See par. 12, and par. 46, for description of sugar and sirup testers.) **(56) Sugar Beet Sirup.**

1. Wash and cut in thin slices. The thinner the slices the better.

2. Place slices in a pot and barely cover with water. Bring to the simmering point or to 175° to 180° F. and keep at this temperature about 45 min. Strain off the hot sugary liquid through a cheesecloth. It is not necessary to press the beets. A second more dilute juice can be obtained by heating the slices with fresh water.

3. Strain the juice till fairly clear. Boil down rapidly to a heavy sirup and skim off material that comes to the surface. Seal hot in scalded jars, bottles, or cans. This sirup will be dark colored but is suitable for some forms of cooking and for table use.

## CHAPTER XXIV

### JELLIES AND MARMALADES

The recipes given in this chapter are designed primarily for the making of jellies and marmalades in the home. Especial attention has been given to the jelly tests. These are of great value in determining when a jelly or marmalade has been boiled long enough; in determining whether a given fruit is suitable for jelly making; and in determining how to correct a fruit that has been proven by test to be unsuitable.

#### (57) Jellies.

1. *Fruits for Jelly.* Most apples, crab apples, loganberries, currants, cranberries, sour blackberries, lemons, oranges and lemons mixed, grape fruit, guava and lemon mixed, sour plums, and Eastern varieties of grapes give good jellies. Other fruits must be mixed with fruits rich in pectin or their juices must be mixed before a good jelly may be obtained. Oranges must be thoroughly ripe, or the jelly will be bitter.

2. Crush or slice the fruit. Add water to cover unless the fruit is very juicy; for example, loganberries and currants require no water. Currants, berries, and other soft fruits are heated to boiling for not longer than 5 min.; boil apples about 20 min. and citrus fruits about 1 hour. If the water boils off too much, add more during the boiling process.

3. Pour the hot fruit and juice into a jelly bag and drain off the hot juice. Press the residual pulp and keep the pressed juice separate from the strained juice. Strain the juice till clear.

4. *Pectin Test.* To test whether the juice has sufficient



pectin to make a jelly, first obtain a little grain alcohol from the druggist. Place 1 teaspoonful of alcohol and 1 of juice in a glass and mix. If after 4 or 5 min. standing a heavy gelatinous precipitate forms, the juice has sufficient pectin; if the precipitate is small, a fruit juice richer in pectin must be added or less sugar than usual must be added. The pectin test is useful but not necessary.

5. *Acid Test.* Compare the taste of the juice with a dilute lemonade made of 8 teaspoonfuls of water and 1 of lemon juice and  $\frac{1}{2}$  teaspoonful of sugar. If the juice is very much less tart in taste than the lemonade, an acid juice must be added to the fruit juice to make up the deficiency. This test is useful but not necessary.

6. *Addition of Sugar.* If the juice is rich in pectin and acid, add 1 cup of sugar to each cup of juice; if only moderately rich in these constituents, add only  $\frac{3}{4}$  cup of sugar to 1 of juice; if poor in pectin, add only  $\frac{1}{2}$  cup of sugar to 1 of juice.

7. *Boiling.* Boil in small lots on a rapid fire. Skim if necessary. The skimmings are good food; do not waste them.

8. *Jelly Tests.* Boil until the jelly "sheets" in large pieces from a spoon. A better test is to insert a candy thermometer; or a chemical thermometer reading to 250° F. The jelly is done when it boils at 220° F.

Another test is the appearance of the bubbles during boiling. The jelly is done when the bubbles become very large and the jelly "tries to jump out of the pot into the glass."

Another very good test is the hydrometer test. Pour the hot jelly into a cylinder. Insert a Baumé or Balling hydrometer. The jelly is done when it tests 30° Baumé or 57° Balling. For very hot climates boil down to 32° Baumé or 60° Balling.

9. Pour into dry glasses and allow to cool.

10. *Paraffining.* Add hot paraffin to the cold jelly to cover it. If a thin knife blade is run around the edges of the jelly after adding the paraffin, it will run down the sides of the glass and make a seal that will not be so apt to "leak" or "sweat."

11. *Some Causes of Failure.* They are use of fruit too low in pectin or acid and the use of too much sugar. Very few cases will be found where more than 1 cup of sugar to 1 of juice can be used. The poorer the fruit is for jelly making the less sugar can be used.

### (58) Jelly Stocks.

Fruit juices for jelly making can be sterilized and used later at any time for jelly.

1. Prepare the juice for jelly making as in Recipe 57 but do not add sugar.

2. Heat to boiling and pour into scalded jars or bottles. Seal at once with scalded corks or caps. Invert to cool so that the hot juice will sterilize corks and jars. Seal corks by dipping ends of bottles in melted paraffin.

3. The juice may also be put up as follows: Bottle and seal with sterilized corks. Pasteurize as described for apple juice in Recipe 41 at 175° F. for 20 min.

4. To make jelly from this jelly stock, open at any time and proceed as with fresh juice under Recipe 57.

### (59) Jellies without Cooking.

Currants, loganberries, and cranberries will make jelly without cooking because they are exceedingly rich in pectin and acid.

1. Crush the fruit very thoroughly and press as completely as possible. Do not heat the fruit or juice. Strain the juice.

2. Add 1½ cups of sugar to each cup of juice and mix until sugar dissolves. Pour into glasses (preferably shallow ones), and leave in the sun. The juice will set to a jelly in a few days. The sun evaporates the excess

moisture. A bright sun is necessary. After jelly has set, seal with paraffin.

**(60) Orange Marmalade.**

1. Use 12 oranges to 3 lemons. Cut 4 of the oranges in very thin slices. Cut the remaining 8 oranges and 3 lemons into medium slices.

2. To the 8 oranges and 3 lemons add water to cover. Boil slowly for 1 hour. Add water occasionally to replace that boiling off. Press out the juice and strain till clear.

3. To the thinly sliced 4 oranges add water to cover and boil slowly till tender ( $\frac{3}{4}$  to 1 hour). Drain off the juice. *Do not press.* The slices must be kept whole. Strain the juice and add to that from the first 8 oranges.

4. Mix the thin slices with whole lot of juice.

5. Add 1 cup of sugar to each cup of mixed juice and slices. Boil slowly until a good jelly test is obtained or until the marmalade boils at 220° F. or until the liquid tests 32° Baumé or 60° Balling.

6. Allow to stand in the pot about 5 min. or until the liquid cools to about 160° F. before pouring into glasses. This allows the slices to absorb the sirup and prevents their coming to the surface. Pour into glasses. Allow to cool and seal with hot paraffin.

**(61) Grape Fruit and Other Marmalades.**

1. *Grape Fruit Marmalade.* Proceed as in Recipe 60 but use grape fruit instead of oranges. Use the same amount of lemon as in Recipe 60.

2. *Apricot and Peach Marmalade.* Prepare an apple juice rich in pectin by boiling apples and pressing as for jelly. To each cup of this juice add  $\frac{3}{4}$  cup of sugar and about  $\frac{1}{4}$  cup of finely sliced peaches or apricots. Boil down until a good jelly test is obtained. Pour boiling hot into glasses and seal.

Other marmalades may be made in a similar way.

## CHAPTER XXV

### FRUIT JAMS, BUTTERS, AND PASTES

These three products offer convenient ways of using many soft fruits unsuitable for canning, *e. g.*, overripe berries, apricots, plums, peaches, and surplus apples. Butters are often made with the use of sirups instead of sugar; fruit sirups made as directed in Chapter XXIII can be used for this purpose, and in this way the sugar bill may be cut materially.

#### (62) Fruit Jams.

1. Weigh the fruit after peeling, pitting, etc. Add a little water and cook till soft. Mash with a potato masher or spoon or pass through a colander. If the fruit is very soft, boiling is unnecessary before adding sugar

2. Add 1 lb. of sugar for each pound of fruit. Boil about 5 min.

3. Pack boiling hot into scalded jars or cans and seal.

4. *Fruits for Jams.* Apricots, peaches, figs, tomatoes, blackberries, loganberries, raspberries, strawberries, and loquats are especially good for jams.

#### (63) Fruit Butters with the Addition of Sugar.

Fruit butters are made both with and without sugar addition. They are usually heavily spiced.

1. Boil the peeled fruit in its own juice (or add a little apple juice or grape juice), until it is soft and of a mushy consistency.

2. Pass through a screen to give a fine grained pulp. To each pound of pulp add  $\frac{3}{4}$  lb. of sugar. To each 10 lbs. of pulp add 3 teaspoonfuls ground cinnamon and 2 teaspoonfuls ground cloves.

3. Boil slowly to a thick "butter" that can be used for spreading on bread. Pack boiling hot into jars and seal. Apples and peaches are the fruits most commonly used for fruit butters. Apricots are also good for this purpose.

**(64) Fruit Butters without the Use of Sugar.**

1. Peel and pit the fruit. Add enough juice to prevent scorching. Cook till soft. Pass through a fine screen.

2. To the pulp add 3 qts. of apple or grape juice per quart of pulp and to each 4 qts. of the mixture 2 teaspoonfuls of ground cinnamon and 1 of ground cloves. If apple or grape sirup prepared as directed in the recipe for sirup for cooking purposes is used, add 1 qt. of sirup to 1 qt. of pulp instead of using the juice as noted above.

3. Boil down to a thick butter. Seal boiling hot in jars or cans. This butter will be very tart and will be suitable for a relish.

**(65) Fruit Pastes or Fruit Bars.**

1. Cook the fruit until tender. Pass through a fine screen or sieve. Berries, apricots, figs, peaches, apples, and quinces may be used.

2. To the fine pulp thus obtained, add 1 cup of sugar per cup of pulp or add  $\frac{1}{2}$  cup of sugar and  $\frac{1}{2}$  cup of fruit sirup per cup of pulp.

3. Cook down over a slow fire to a thick butter or jam. By carrying on the last part of the concentration in a double boiler scorching will be avoided. Cook down as far as possible without scorching.

4. Pour or spread in a broad shallow baking pan or on a glass or marble slab to the depth of about  $\frac{1}{2}$  inch. The pan or slab must be greased with salad oil or butter to prevent the paste sticking to it.

5. Allow the material to stand in the breeze for 3 or 4 days to further dry out. Then cut in cubes and roll

in powdered sugar. Allow to stand in a draught or breeze a few days longer. Then pack in candy boxes.

6. Grated nuts or citron peel may be added while the pulp is cooking and just before it is finally taken from the fire.

Confections of this kind may be used as candies or as garnishings for various dishes. Various flavors such as vanilla or lemon may be added to the pastes.

## CHAPTER XXI

### RECIPES FOR PRESERVES

Practically all fruits may be made into preserves, but some are better suited to the purpose than others. These have been emphasized in the recipes in this chapter.

#### **(66) Fig Preserves.**

1. Choose figs preferably of some white variety and not overripe. Puncture them with a silver fork thoroughly so that sirup will penetrate easily.

2. Place figs in a kettle. Add 1 lb. of sugar to each pound of figs and 2 pints of water to each pound of figs.

3. Cook down slowly until the figs have become a heavy preserve. Pack boiling hot in scalded jars and seal.

#### **(67) Peach, Pear, Quince, and Other Fruit Preserves.**

1. Peel and prepare as for canning. Cut pears in half and quinces in quarters.

2. Add 1 lb. of sugar and 2 pints of water to each pint of fruit.

3. Cook down to a heavy preserve; pour into jars and seal hot.

#### **(68) Strawberry Preserves.**

1. Weigh the berries and add 1 lb. of sugar to each pound of berries. A little cochineal may also be added to color the berries because they tend to fade after cooking.

2. Heat quickly to a boil and boil about 2 min., not longer.

3. Pour into a shallow tray or baking pan and set in the sun until the liquid evaporates to a thick sirup and the berries have become plump. It will usually be necessary to cover the pan with a cheesecloth during the ex-

posure to the sun. About a week's time will usually be necessary for the sirup to evaporate.

When they have reached the desired point, pack in jars or glasses and seal with paraffin.

Strawberries preserved in this way will be much more attractive in texture, color and flavor than those prepared in the usual household way.

#### **(69) Watermelon Preserves.**

1. The white portion of the melon between the colored flesh and rind is best for melon preserves. Trim off the rind and colored flesh and cut into cubes of desired size.

2. Weigh carefully. Drop in boiling water and boil about 5 to 10 min. Remove and drain.

3. Add 1 lb. of sugar,  $\frac{1}{2}$  pint of water and the juice of  $\frac{1}{2}$  a lemon to each pound of melon. Boil down to a heavy preserve.

#### **(70) Tomato Preserves.**

1. Use a very small variety of tomato; there are many varieties that produce tomatoes about the size of prunes.

2. To each 4 lbs. of tomatoes, add 4 lbs. of sugar,  $1\frac{1}{2}$  qts. of water,  $\frac{1}{2}$  teaspoonful of ground ginger and 1 teaspoonful of ground cinnamon. Boil down to a heavy preserve and seal hot.

#### **(71) Preserved Kumquats.**

1. The kumquat is a small citrus fruit of oblong shape and of the size of a small prune. Slit the kumquats lengthwise for about  $\frac{2}{3}$  the length of the fruit in three places. Boil in water till tender. With a knife blade or fork remove the seeds.

2. For each pound of fruit boil together 1 lb. of sugar and 1 pint of water for 5 min. Add the kumquats and cook down until transparent.

3. Place the fruit carefully in a shallow pan and cover with the sirup. Allow to stand overnight to plump.

4. Pack in jars. Place in a washboiler sterilizer and sterilize 10 min. at  $212^{\circ}$  F.



**(72) Preserves Made Without Cooking.**

1. Berries and currants may be prepared in this way. Stem the berries.

2. Weigh the berries and allow 1 lb. of sugar for each pound of berries. Place the berries in a shallow pan.

3. To each pound of sugar add  $\frac{1}{4}$  pint of berry juice. Boil the juice and sugar together and pour it boiling hot over the berries.

4. Place the pan in the sun and leave until the fruit has taken up enough sirup to become plump and the sirup has become very thick.

5. Pack in glasses and seal with hot paraffin.

## CHAPTER XXVII

### RECIPES FOR CANDIED FRUITS

If large amounts of fruit are to be candied, Recipe 73 should be used, because it may be accurately controlled by the use of a sirup hydrometer; if only a small amount is to be made, then Recipe 74 will be found suitable, as no sirup hydrometer is needed when it is followed. Success in candying of fruit depends largely upon slow increase in the sugar content of the sirups used in candying, and in care in preventing fermentation during the candying process.

#### **(73) Candied Fruits with Use of Sugar Tester.**

1. *Preparation of Fruit for Cooking.* Puncture cherries, figs, kumquats, loquats, crabapples and apricots, through and through in several places with a silver fork; peel pears and peaches; core or pit and cut in half. Cut pineapple in rings as for canning or use the canned product. Fruit for candying should be firm ripe but not soft. Canned fruits may be used instead of the fresh fruit.

2. If fresh fruit is used, cook carefully in water until tender. Avoid breaking the fruit. Place the cooked fruit in a pan or stoneware crock or other convenient vessel.

3. Prepare a sirup of glucose or Karo Korn sirup and water using 1 cup of the glucose or Karo to 2 cups of water. Heat this sirup to boiling and cover the fruit with it. Allow fruit and sirup to stand 24 hours. If the fruit floats, place a wooden float or a tin pot cover upon it to keep it submerged.

4. After 24 hours pour off the sirup and test it with a

Balling or a Baumé hydrometer or sugar tester. This is done by pouring the sirup into a cylinder or tall jar and inserting the hydrometer. Read the degree at the surface of the liquid. See Fig. 32. Add sugar to increase the sirup to 35° Balling or to 20° Baumé. This can be done by trial. Heat the sirup to boiling and pour it back on the fruit.

5. After 24 hours pour off the sirup and add sugar to increase the sirup to 35° Balling or 23° Baumé. Pour it back boiling hot on the fruit.

6. At 24 hours intervals repeat the above process adding sugar to increase the sirup to 40, 45, 50, 55, 60, 65, and 70° Balling, respectively, or to 25, 27, 29, 31, 33, 35, and 37° Baumé. The final sirup should be 70° Balling or 37° Baumé. Allow the fruit to stand in this heavy sirup for 3 or 4 days.

7. Then remove the fruit. Place it on a coarse screen and allow it to dry about a week in a breeze or draught in the house.

8. Pack the candied fruit in pasteboard or wicker boxes. Do not use closed jars because the fruit will mold in sealed containers. Open jars may be used.

#### **(74) Candying Fruits without the Use of a Sugar Tester.**

1. Proceed exactly as in the preceding recipe under (1) and (2).

2. Prepare a sirup of Karo Korn sirup or glucose, 1 cup and water 2 cups. Heat this to boiling and pour it on the prepared fruit. Leave 24 hours.

3. After 24 hours pour off the sirup and to each 4 cups add  $\frac{1}{2}$  cup of sugar. Heat to boiling and pour back on the fruit.

4. At intervals of 24 hours repeat this process adding  $\frac{1}{2}$  cup of sugar to each 4 cups of sirup each time until the sirup becomes very thick and of about the consistency of thick honey. Leave the fruit in this sirup for about 1 week.

## 210 HOME AND FARM FOOD PRESERVATION

5. Remove the fruit and drain it. Place it on a coarse wire screen and allow to dry for about 1 week in a room where a draught or breeze will strike it.

6. Pack in pasteboard or wicker boxes or open jars. Do not use sealed containers.

## CHAPTER XXVIII

### RECIPES FOR THE DRYING OF FRUITS

The following fruit drying recipes cover both evaporation by artificial heat and by solar heat. The latter method gives satisfactory results only in climates that are free from frequent summer rains. The general principles of fruit drying will be found discussed in Chap. XII. This chapter should be read in connection with the recipes.

#### (75) Sun Drying Apricots, Pears, Peaches, and Apples.

1. Apricots, peaches, and apples are allowed to ripen on the trees. Pears are picked when they are full size but still hard and are allowed to ripen in lug boxes or on piles of straw. Fruit for drying must be ripe but not so soft that it will melt down on the drying trays.

2. Cut apricots and peaches in half and remove pits. Peaches may be lye or hand peeled (see Recipe 2), but this is not necessary. Cut pears in half; do not peel. Peel, core, and cut apples in rings about  $\frac{1}{4}$  inch thick (see apple peeler, Figs. 4 and 58). Place the fruit on trays. These are made of shakes or thin lumber and are 2 x 3 ft., 6 x 3 ft., or 8 x 3 ft. usually. If trays are not available use paper or cloth or wire screen or any flat surface exposed to the sun.

3. *Sulphuring.* Fig. 39 illustrates a sulphur box. Any closed space in which the trays of fruit may be stacked and exposed to the fumes of burning sulphur may be used. An old pan may be used to hold the sulphur. Place the trays of fruit in the sulphuring house. Place enough sulphur in a pan to burn for the required length of time (see time given below), 5 lbs. per ton will be

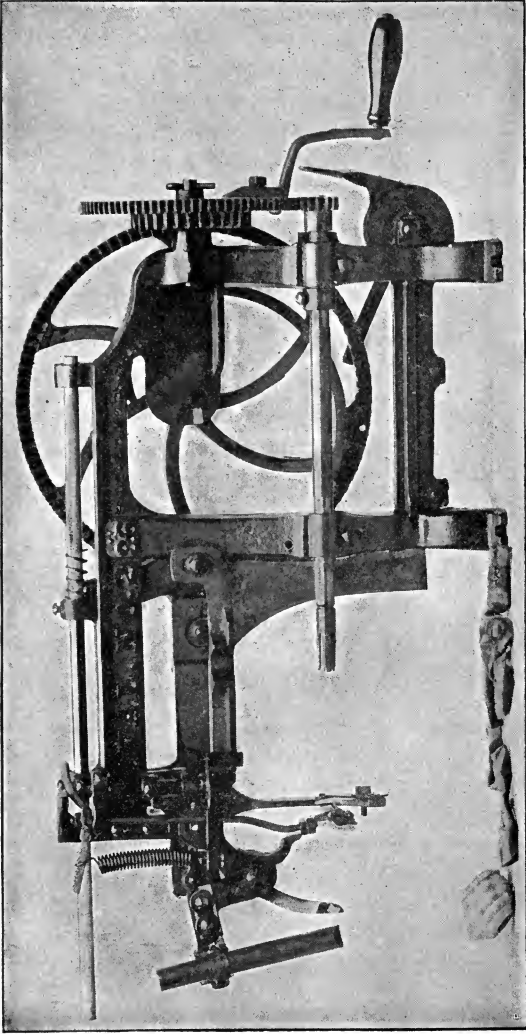

Fig. 60. Apple Peeler for Farm Use. (Courtesy of Berger and Carter)

enough for most fruits. Light the sulphur. This can be done by placing some shavings in the pan, lighting these and pouring the sulphur on them. Place the burning sulphur in the sulphur house and close the door. Expose apples to the burning sulphur fumes 30 min.; apricots and peaches 3 hours and pears 6 hours. Sulphuring prevents the fruits darkening and molding during drying.

4. Place the fruit in the sun to dry. Dry until it becomes leathery and tough but not brittle. A better product will be obtained if the trays are stacked one above the other in stacks of 10 or 12 trays each when the fruit is about  $\frac{3}{4}$  dry. It will then finish drying in the shade and will be of more uniform quality.

5. *Sweating.* Sweating consists of equalization of the moisture content. Put the dried fruit in large boxes or in bins and leave a week or 10 days. It is then ready for selling to the packing house.

6. *Processing.* If the fruit is for home use and is not to be sold to a packing house, it must be sterilized to prevent its being spoiled by insects that come from insect eggs deposited on the fruit during drying. To do this plunge the fruit into violently boiling water for about 1 min. Drain. Dry on trays in the sun for a few hours. The dipping destroys insects and their eggs.

7. *Packing and Storing.* Pack the fruit in heavy paper bags or in jars or other insect proof containers. Plain cloth or burlap bags are not insect proof. Store in a dry place.

8. *Precautions.* A dry rainless climate is essential to successful sun drying. In case of rain, stack the trays one above the other and cover with a rain shedding cover, or bring the fruit indoors until the rain has passed. Do not use wood for trays that will give a disagreeable flavor or color to the fruit.

#### (76) Sun Drying Prunes.

1. Allow fruit to ripen thoroughly on the trees, and

if possible permit it to drop from the trees before picking.

2. *Dipping.* Prepare a lye solution of  $\frac{1}{2}$  an oz. of lye per gallon of water. This will be approximately  $\frac{1}{2}$  a tablespoonful per gallon or 5 oz. per 10 gallons. Heat this to boiling in an iron or agateware pot; aluminum dissolves. Place the prunes in a wire basket. Immerse them in the boiling lye solution long enough to check or crack the skins slightly over the entire surface. This will require about 10 seconds. The time will vary with the variety of the fruit and its condition. Rinse in cold water after the lye dipping.

3. Spread on trays and dry in the sun. It will usually be necessary to occasionally stir or turn the fruit on the trays during drying to prevent sticking to the trays and molding.

4. *Stacking the Trays.* When the fruit is about three-fourths dried stack the trays one above the other and allow drying to complete. This will prevent overdrying and gives a more evenly dried product.

5. *Storing and Processing.* As for apricots. (See Recipe 75.)

#### **(77) Drying Thompson Seedless and Sultana Grapes.**

1. Raisin making requires a dry hot climate free from rains. Dip the ripe grapes in a lye solution as directed for prunes. Rinse in water.

2. *Unsulphured Raisins.* Dry in the sun until three-fourths dry. Stack the trays and allow drying to complete. During drying it will be necessary to turn the grapes by inverting one tray over another. This is done when the grapes are dried about one half. It is done to equalize drying. This gives a brown raisin. If a bleached, white raisin is desired, proceed as directed in step 3.

3. *Sulphured Raisins.* If a bleached white product is desired, place the dipped grapes on trays and expose



to fumes of burning sulphur for 3 hours. Then dry in the sun in usual way.

**(78) Drying Muscat and Currant Grapes.**

1. These varieties are not dipped or sulphured. Pick when ripe. Spread on trays and expose to the sun.

2. When about one-half dry turn the grapes by placing an empty tray over the loaded tray. Turn the two quickly and remove the upper one. This exposes to the sun the grapes that were previously on the bottom of the bunches and next to the tray.

3. When the grapes are about three-fourths dry, stack the trays and allow the grapes to finish drying in the stack.

**(79) Packing Raisins.**

1. Raisins are usually commercially packed as follows: The stems are removed by stemming machine. The seeds of Muscat raisins are removed by a seeding machine. The raisins are packed in wax paper-lined cartons. They must be stored secure from insects. Dipping in boiling water before packing will kill insect eggs.

**(80) Sun Drying Cherries.**

1. Cherries may be dried in the same way as directed for prunes or may be dried without dipping.

**(81) Sun Drying Figs.**

1. Allow the figs to partially dry on the trees and drop of their own accord. A dry hot climate is necessary.

2. Place on trays and dry in the sun.

3. *Bleaching.* If a bleached fig is desired, dip the dried white figs in boiling water for about 3 min. Expose to sulphur fumes 3 hours. Dry in the sun.

4. *Packing and Storing.* Commercially the dried figs are slit from stem to calyx on one side and spread flat. They are packed and pressed into bricks. These are wrapped in paraffined paper and placed in cartons. For home use they may be sterilized by dipping in boiling

water 1 min.; drying a short time and then packing in insect proof containers.

**(82) Drying Fruits in Evaporators.**

1. In rainy or moist climates, or late in the season, artificial dryers may become necessary. Build one to suit your needs. (See Chap. XII, par. 67, for description and figures of evaporators.) Trays with wire screen bottoms will be needed to facilitate the passage of heat. A thermometer will be necessary.

2. Prepare the fruit for drying as previously described under Recipes 75 to 81, inclusive, and place on the dryer trays. If the fruit is to be sulphured, sulphur as directed in preceding recipes.

3. *Apples.* Start the evaporator at 110° F. and gradually raise to 140° F. near the end of drying. They should dry in 8 hours or less. Apples should be sulphured for 20 min. before drying.

4. *Apricots and Peaches.* A temperature of 120° F. may be used to start. Gradually increase to 140° F. They should be dry in 6 hours.

5. *Berries.* Dry very slowly at first (110° to 120° F.), for about 2 hours, starting at 110° F. and gradually reaching 120° F. in the above time. Gradually increase to 130° F. and complete most of the drying at this temperature. Too rapid heating causes dripping and melting. They should dry in 5 hours.

6. *Cherries.* Start at 110° F. and increase slowly to 150° F. About 4 hours will be necessary.

7. *Pears.* Dry after cutting in half and sulphuring 6 hours. Start at 110° F. and increase slowly to 140° F.

Or peel, core, cut in eighths and dry without sulphuring as above.

8. *Prunes.* Dip as in Recipe 76. Dry as directed for cherries above.

9. *Grapes.* All grapes should be dipped in boiling lye solution of  $\frac{1}{2}$  oz. per gallon, and rinsed in cold water

before drying. See Recipe 77. Start drying at 110° F. and increase to 140° F. Temperatures above 140° F. will give a "scorched" or caramelized taste to the raisins.

10. *Figs.* Allow to dry as much as possible on the trees. Place in the evaporator. Start at 110° F. and increase slowly to 140° F.

11. *Processing and Storing.* Artificially evaporated fruits contain no insect eggs. As soon as dry, pack in insect proof packages and store in a dry place.

## CHAPTER XXIX

### RECIPES FOR THE DRYING OF VEGETABLES

Vegetables may be readily sun dried in most climates but the quality of sun dried vegetables is usually not so high as that of artificially dried vegetables. Sun dried vegetables are usually exposed to attacks by insects, and insect eggs are usually deposited upon them during drying. This makes it imperative to sterilize vegetables that have been dried in the sun, to make certain that they will not be destroyed by insects during storage later. Careful attention should be therefore paid to the directions given in the various recipes for the sterilization of dried vegetables.

#### **(83) Sun Drying String Beans and Peas.**

1. String the beans and break into lengths as for cooking. Shell the peas. Peas and beans for drying should be young and tender. The vegetables will not become so tough during drying if they are parboiled 10 minutes before drying.

2. Spread on trays in the sun. Allow to dry about one-half day in sun. Then stack the trays one above the other or place the trays in the shade to finish drying. This will prevent bleaching.

3. *Processing and Storing.* Dip in boiling water for  $\frac{1}{2}$  to 1 min. when dry to kill insect eggs; dry in the sun a few hours and pack in insect proof packages. Or the dried vegetables may be sterilized by heating in an oven long enough to heat them through thoroughly. This is a very satisfactory method. Peas are liable to attack by weevils unless sterilized as above.

**(84) Sun Drying Corn.**

1. Use freshly picked sweet corn. Cook in boiling water for 10 min. Remove and cut from the cob.
2. Spread on trays and dry in the sun.
3. Sterilize and store as directed for peas and beans. (Recipe 83.)

**(85) Sun Drying Irish Potatoes.**

1. Cook until almost done. Peel.
2. Slice and spread on trays. Dry in the sun until brittle.
3. *Alternative Method.* Peel. Slice the raw potatoes and spread on trays. Expose to sulphur fumes for 20 min. Dry in sun.
4. *Storing.* As in Recipe 83.

**(86) Sun Drying Sweet Potatoes.**

1. Cook with skins on until almost done. Peel and slice.
2. Dry in the sun.
3. Store as in Recipe 83.

**(87) Sun Drying Carrots, Turnips, Onions, Cabbage, and Cauliflower.**

1. Peel and slice carrots and turnips. Slice the cabbage. Break the cauliflower heads into small pieces. Place on trays.
2. Expose to fumes of burning sulphur for 30 to 40 min. (See Chap. XII, par. 64, for description of sulphuring box.)
3. Dry in the sun. Store as in Recipe 83.
4. *Alternative Method.* Prepare as in 1. Parboil in boiling water 10 min. Spread on trays and dry in the sun. This method produces darker colored dried vegetables than where sulphur is used but is probably better adapted to household use.

**(88) Sun Drying of Beets, Pumpkin, and Squash.**

1. Peel and cut in slices about  $\frac{3}{8}$  in. thick. Place on trays and dry in the sun. No sulphuring or parboiling are necessary.

2. It will usually be necessary to turn the vegetables occasionally during drying to prevent molding.

3. Store as directed in Recipe 83.

4. *Alternative Method for Beets.* Parboil the beets until they may be peeled easily. Peel, slice and dry.

### (89) Sun Drying Tomatoes.

1. Use ripe firm fruit. Cut in half and place on trays with cut side uppermost.

2. Expose to fumes of burning sulphur for 1½ hours.

3. Dry in the sun.

4. *Alternative Method.* Cut in half and sprinkle cut

surfaces with salt. Dry in the sun. This gives a darker product.

5. Process and store as in Recipe 83.

### (90) Sun Drying Peppers.

1. Use ripe red peppers.

2. String on a coarse thread and hang the peppers in the sun until almost dry. Hang in the kitchen to complete drying.

3. *Storing.* A good way to store dried peppers is to merely hang them from the ceiling or a nail on the string on which they were dried. No processing is necessary.

### (91) Drying Vegetables in an Artificial Evaporator.

1. Prepare for drying as directed in Recipes 83 to 90, inclusive. Use an evaporator with wire screen trays and equipped with a thermometer. Any of the forms described and figured in Chap. XII, par. 67 may be used.

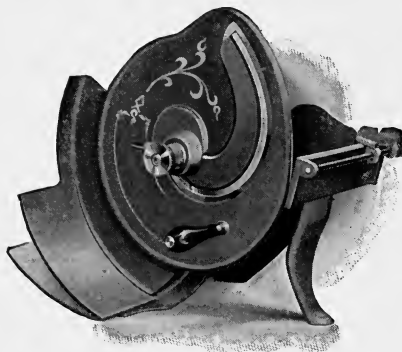

FIG. 61. Hand Power Vegetable Slicer  
(Courtesy Berger and Carter)

## RECIPES FOR THE DRYING OF VEGETABLES 221

2. Begin drying at 110° F. and gradually increase the temperature to 145° F. until vegetables are brittle dry.

3. Allow the vegetables to stand in a bin or box securely covered with a cloth to exclude insects. They will in a few days absorb enough moisture to become leathery and tough.

4. Store in insect proof packages. If cloth or burlap bags are used, first tie in paper to exclude insects. Store in a dry place.

## CHAPTER XXX

### RECIPES FOR THE MAKING OF VINEGAR

The principles of fermentation and vinegar making will be found discussed in Chapter XIV. If these principles are understood the following recipes will be much more useful. The use of good material must be emphasized; good vinegar cannot be made from partially decomposed fruits. Nevertheless, cull fruits, if sound, fruit peelings, cores, etc., can be used to good advantage.

#### (92) Home Manufacture of Vinegar from Whole Fruits.

1. Crush the fruit and heat to boiling. Press out the juice through a jelly bag or coarse cloth. Allow the juice to cool overnight in an agateware pot or stoneware crock or wooden bucket or barrel. If fruits are soft and juicy, heating is not necessary.

2. On the next day break up a yeast cake for each 5 gals. or less of juice and mix it with the juice. In 24 hours the juice will be fermenting. Allow the juice to stand in the crock, or bucket, etc., until fermentation ceases. This will require about 2 to 3 weeks. Allow to stand 1 week longer for the yeast to settle. This will make a total of 3 to 4 weeks from the time the fruit was pressed.

3. When fermentation is over and the yeast has settled, pour or draw off the fermented liquid into another container of the same kind in which fermentation has taken place or pour it off and return it to the original containers.

4. To each gallon of the liquid add 1 pint of good vinegar, preferably vinegar from a barrel. This adds a



starter of vinegar bacteria and the vinegar acid favors a rapid start of vinegar fermentation.

5. Cover the jar or bucket, etc., with a cheesecloth so that insects will be screened out and so that air may get to the liquid freely. An abundant supply of air is necessary for vinegar formation. If a barrel is used arrange it as shown in Fig. 49. The barrel should be left about two-thirds to three-fourths full. Leave the bung open and bore a hole at each end of the barrel just above the surface of the liquid as shown in Fig. 49. Cover the holes with fine screen or cheesecloth to keep out insects. Leave in a warm place until vinegar forms. This will be in 2 to 12 months, depending on temperature conditions. A warm room is best.

6. The vinegar may then be drawn off and strained or filtered and should be bottled or stored in completely filled and closed barrels to prevent deterioration.

**(93) Vinegar from Cores, Peels, and Fruit Scraps.**

1. Often fruit scraps are wasted. These will make good vinegar.

2. To each cupful of scraps, add 2 cups of water or enough to cover well. Boil about 10 to 15 min. and press out the juice.

3. To each 10 cups of liquid add 1 cup of sugar and stir until dissolved. Allow to cool overnight in a jar or other convenient container. (Do not use tin.)

4. Proceed from this point as in Recipe 92.

**(94) Vinegar from Honey and Sirups.**

1. To each cup of the honey or sirup add 4 cups of water and a half cup of any fruit juice.

2. Mix well and proceed from this point as in Recipe 92.

**(95) Clarifying Vinegar.**

1. *With Fish Isinglass.* If a large amount of vinegar is to be made for sale it should be made as clear as possible. This may be done by filtration until clear or may

be accomplished by clarification. Fish isinglass is most commonly used for this purpose. The Russian isinglass is best.

If the vinegar is very cloudy, weigh out 2 oz. of isinglass for each 100 gals.; if moderately cloudy, 1 oz. and if only slightly cloudy,  $\frac{1}{2}$  to  $\frac{3}{4}$  oz. Soak each ounce in about 1 gal. of vinegar for several days. It will swell and become soft. Break it up thoroughly and work it into solution in the vinegar. Pressing it through a fine screen will aid. Then add it to the larger lot of vinegar in the proportion required as noted above. Stir well and let settle until clear. Draw off the cleared vinegar with a hose or through a spigot.

2. *With Spanish Clay.* This is a clay of poor pottery clay grade. For each 100 gals. of vinegar weigh out 5 to 8 lbs. of clay, depending on the cloudiness of the vinegar. Soak in the proportion of 1 lb. of clay to 1 gal. of vinegar until soft. Work up into a thin mud in the vinegar; it must be finely broken up into a smooth mud or "solution." This will require a great deal of crushing and stirring. An old butter churn may be used. Add the clay solution to the vinegar in the amount required (5 to 8 lbs. clay per 100 gals. of vinegar). Stir. Allow to settle several days. Draw off clear vinegar and filter the sediment.

## CHAPTER XXXI

### RECIPES FOR FRUIT WINES

The following recipes for fruit wines are designed for the home or very small scale manufacture of these fermented fruit juices.

#### (96) Red Wine.

1. Use ripe red wine grapes of good color. Crush them thoroughly into a wooden tub or open barrel or open stoneware jars. Crushing may be done with a fruit crusher or with the hands. Place in a warm place.

2. In a day or two fermentation will start. Stir the grapes thoroughly and vigorously three times daily for about one week. By this time the juice should be deep red in color; if not, leave a few days longer.

3. Press out the fermenting red juice from the skins and stems. Place it in a cask or barrel or demijohn and leave in a warm place till fermentation is over. Then fill the barrel or demijohn with wine and place a barrel bung or cork in loosely to close it. Do not drive it in. Leave thus for about 2 or 3 weeks. Then drive the bung or cork in tightly. Leave for three weeks longer. Then draw off the wine from the sediment and transfer to other barrels or bottles, filling them full and sealing tightly. If barrels are used they should be filled up occasionally, once a month, with wine to replace that lost by evaporation.

4. After 6 months draw off the wine again and fill into clean barrels or demijohns and seal. Repeat after 6 months.

5. Store till wine is aged sufficiently to be used. This will usually not be under 1 year. It may then be bottled,

corked and stored till used. Bottling stops further aging and checks deterioration.

6. *Suggestions.* Better results will be obtained if a culture of wine yeast is used for fermentation. Such a culture can be obtained from the Division of Viticulture, University of California, Berkeley, for one dollar. Grapes must be sound and not moldy. Keep all utensils scrupulously clean.

**(97) White Wine.**

1. Crush ripe white grapes and press out the juice.
2. Allow to ferment in a barrel, cask, or demijohn in a warm place. When fermented completely, proceed as directed for red wine.

**(98) Hard Cider from Apples, Oranges, and Other Fruits.**

1. *Yeast Starter.* Crush and press out the juice from a small amount of sound fruit. Place this in a jar in a warm place. When this is fermenting rapidly (after about 4 or 5 days), it may be used to start a larger lot. Make enough for 1 gal. of yeast to each 10 gals. of juice.

2. Crush and press the main lot of fruit. Add 1 gal. of the yeast starter from (1) to each 10 gals. of juice and mix thoroughly.

3. Allow to ferment until fermentation ceases. Fill the containers with fermented or hard cider and close them with bungs or corks as the case requires.

4. Allow to settle several weeks. Draw off from the sediment and filter as clearly as possible. Store in well filled and closed containers. The cider will be ready for use in a few months. It should then be bottled to prevent deterioration.

## CHAPTER XXXII

### RECIPES FOR THE PRESERVATION OF VEGETABLES BY SALT OR FERMENTATION

Vegetables may be preserved by heavy salting with dry salt, by storage in strong brine and by fermentation in a weak brine or in the presence of a small amount of salt. Recipes for the use of all three methods are given. If the salting is carefully done, the salted vegetables will be very attractive in flavor and appearance. They will possess more of the fresh vegetable flavor and odor than will canned vegetables. The principles of preservation of vegetables by salt will be found in Chap. XVI, pars. 96 and 97. A knowledge of these principles will be of great assistance in carrying out the directions given in the recipes.

#### (99) Preservation of Vegetables by Dry Salt.

1. Slice or shred the vegetables and weigh. String beans are prepared and broken as for cooking.

2. Weigh 1 lb. of salt to each 4 lbs. of vegetables. Place a layer of the salt in the bottom of a crock or barrel or wooden tub. Do not use metal containers. Build the sliced or broken vegetables and salt up in alternate layers until the container is full. Cover last layer of vegetables with a layer of salt.

3. Place a false wooden head small enough to fit inside the container on top of the mixture. Place a heavy weight on this head. Leave until the liquid is forced out of the vegetables and they are immersed in the brine formed by their own juice and the salt. This will be in about 2 weeks.

4. Remove the false head and weight and seal with paraffin to prevent evaporation of the liquid.

5. The vegetables will keep indefinitely and retain much of the original appearance and flavor of the fresh vegetables. To use them, soak in a large volume of water overnight; for example, by suspending them in a cheesecloth bag near the surface of a large pot of water. Or parboil to remove salt. Then cook and prepare for the table in the usual ways.

#### **(100) Preservation of Vegetables in Strong Brine.**

1. Prepare a brine of  $3\frac{1}{2}$  lbs. of salt per gallon of water. Immerse the whole vegetables in this and keep them submerged by means of a wooden float. Do not use metal containers. This method is especially good for peppers, artichokes, cauliflower and other vegetables not readily preserved by the dry salting process.

2. If the vegetables show mold or fermentation at any time add more salt. They will keep better if the container is sealed with paraffin.

3. Freshen for use as in preceding recipe.

#### **(101) Preservation of Cabbage by Fermentation (Sauerkraut).**

1. Shred the cabbage into narrow strips and weigh.

2. For each 10 lbs. of cabbage weight 6 oz. to 8 oz. ( $\frac{1}{2}$  lb.) of cooking or fine dairy salt.

3. Mix the salt and cabbage very thoroughly in a stoneware crock or wooden container. Place a false head on the cabbage. A wooden head to fit inside the container may be made or a plate may be used for small amounts of material in a crock. Place a heavy weight on the false head (do not use limestone because it is acted upon by the sauerkraut).

4. Leave in a warm place. The juice of the cabbage soon forms a brine. Fermentation will soon start and foam will appear. After about three weeks the kraut should have the desired flavor. When a scum appears,

skim it off. If this scum is left undisturbed, it may completely spoil the product.

5. When fermentation ceases and the kraut has developed the proper flavor, it may be kept by sealing it over with paraffin. A better way is to heat it to boiling and pack boiling hot in jars. Sterilize  $\frac{1}{2}$  hour in a wash-boiler sterilizer at  $212^{\circ}$  F. and seal. It will then keep indefinitely.

### (102) Preservation of String Beans, Beets, and Greens by Fermentation.

1. String and break the beans into lengths as for cooking. They should be small and tender. Peel the beets and slice. Trim greens as for cooking for the table.

2. Weigh the vegetables and for each 10 lbs. of vegetables weigh out  $\frac{1}{2}$  lb. of cooking or dairy salt. Mix vegetables and salt intimately in a crock or barrel. Place false wooden cover and heavy weight on the material. Leave in warm place. The juice of the vegetables will form a brine in which fermentation will take place. The fermentation should be done in 3 weeks.

3. Seal with a thick layer of melted paraffin.

4. Whenever the container is opened to remove material for cooking, it should be resealed again with paraffin.

### (103) <sup>1</sup> Preservation of Vegetables by Fermentation in Brine.

1. Cucumbers, string beans, green tomatoes, beets, beet tops, and turnip tops, peas, corn and peppers may be preserved in this way.

2. Wash the vegetables and drain off the surplus moisture. Pack in a keg or crock or other utensil until nearly full (within about 3 in. of the top). Prepare a weak brine as follows: To each gallon of water used, add  $\frac{1}{2}$  pint of vinegar and  $\frac{3}{4}$  cup of salt and stir until salt is entirely dissolved. The amount of brine necessary to

<sup>1</sup> From Farmers' Bulletin, 881, U. S. D. A.

cover the vegetables will be equal to about one-half the volume of the vegetables.

3. Pour the brine over the vegetables to cover them and keep them submerged by means of a wooden cover. Leave in a warm place until fermentation is over.

4. Remove to a cool place and seal with melted paraffin. If mold has formed, skim it off before sealing. Dill and spices may be added to the brine if desired, when it is poured on the vegetables. Vegetables prepared in this way have a sour taste.

#### (104) Dill Pickles.

1. Wash the cucumbers. Prepare a crock or keg, barrel or wooden bucket. Do not use metal.

2. Place a layer of dill plant in the bottom of the container and a small quantity of mixed "dill pickle spices." These may be obtained from a grocery. Place two or three layers of cucumbers on these spices and dill plant. Add another layer of dill plant and spices and two or three layers of cucumbers, repeating the alternation of layers until the container is almost full.

3. Cover with a layer of beet leaves or grape leaves at least 1 in. thick. Fill and cover with a brine made of 1 lb. of salt, 10 qts. of water and  $\frac{2}{3}$  qt. of vinegar.

4. Allow to stand until fermentation ceases (3 to 4 weeks). Seal with paraffin.

5. If large barrels are used the barrels may be headed up after filling with the cucumbers and spice and then filled with a brine, made as above. Leave the bung-hole open. When fermentation is over the barrel may be completely filled with the brine and the bung-hole closed.

6. Dill pickles may be kept indefinitely by heating to boiling in the brine in which they are made and sealing boiling hot in glass top jars.



## CHAPTER XXXIII

### RECIPES FOR THE MAKING OF PICKLES AND RELISHES

A great many products may be grouped under the heading of pickles and relishes. Directions for the home manufacture of the most important of these are given in the following recipes. The principles involved will be found in Chap. XVI, pars. 98-102, inclusive.

#### (105) Cucumber Pickles in Vinegar.

1. Choose small cucumbers.
2. Prepare a brine of 2 lbs. of salt per gallon of water. Place the cucumbers in this and keep them submerged with a wooden float. Store in this brine for about 4 weeks. Fermentation will take place and a scum will form. If the pickles become soft, add more salt.

3. After about 4 weeks remove the cucumbers and heat them in a large amount of water to the simmering point for about 20 min. Discard this water and cover with fresh water. Heat to the simmering point; remove from fire and let stand about 2 hours to soak out the excess salt. If the pickles tend to be soft or "flabby," add a tablespoonful of alum per gallon of water. This will harden them and not injure health.

4. Rinse in cold water. Drain. Store in strong cider vinegar of good quality until ready for use. If at any time the pickles soften or mold, place them in fresh vinegar. Pack in wide mouth corked bottles or in jars with glass tops. Do not use metal.

#### (106) Onion, Green Tomatoes, and Cauliflower Pickles in Vinegar.

1. Place the vegetables in a brine of 3½ lbs. of salt

per gallon of water. Store for 4 to 6 weeks or longer keeping them submerged in the brine.

2. Remove and treat as directed for cucumbers in preceding recipes (1), (2), and (3).

#### (107) Sweet Vegetable Pickles.

1. Prepare the cucumbers, green tomatoes, etc., as directed in Recipes 105 and 106 to the point where they are ready to be placed in the vinegar. Prick the prepared vegetables through and through in several places with silver fork. This will permit the sweet vinegar to penetrate without shrivelling the vegetables. If they are soft, heat them a short time in water containing 1 tablespoonful of alum per gallon.

2. Prepare a sirup as follows:

3 cups of vinegar ( $1\frac{1}{2}$  pints).

5 " " sugar ( $2\frac{1}{2}$  pints), brown sugar is preferred.

1 tablespoonful mace

1 " " ginger root

2 " " stick cinnamon

1 " " whole cloves

Boil the vinegar and spices together slowly for about 5 min.

3. Heat the pickles in the spiced vinegar to boiling and boil about 10 min. Pack boiling hot into glass top jars and seal.

#### (108) Sweet Fruit Pickles.

1. Peel peaches. They may be left whole or cut in half as desired. Clingstone peaches are the best. Peel pears and cut in half and remove cores. Cherries, plums, and figs should be pricked with a silver fork to permit sirup to penetrate without shrivelling them. Whole Muscat, Tokay or other large grapes may be used. They should be left on the bunch.

2. Prepare a sirup of the following:

3 lbs. of sugar

- 1 pint of water
- 1 " " vinegar
- 1 tablespoonful of ginger root
- 1½ tablespoonfuls of whole cloves
- 2 " " stick cinnamon

3. Place the fruit in this sirup and cook till tender. Allow to stand in the sirup overnight. On the next day pour off the sirup and boil it down until it forms a heavy sirup. If the sirup is thick after standing overnight it will not be necessary to boil it down further. Heat the fruit to boiling in this sirup and pack boiling hot in glass top jars and seal at once.

**(109) Sweet Pickled Watermelon Rind.**

1. Remove outer peel and cut in pieces of desired size. Boil in salt water (4 tablespoonfuls salt per quart), for 15 min. Rinse in water till the flavor of salt is gone.

2. Place in sirup made according to preceding recipe. Boil till clear, pack hot in jars and seal.

**(110) Spiced Green Tomatoes.**

1. Prepare a sirup of the following:

- 4 lbs. of sugar
- 1 pint of vinegar
- 1 tablespoonful of cinnamon
- 1 " " " cloves
- 1 teaspoonful allspice
- 1 " " mace

2. Drop 6 lbs. whole small tomatoes into this sirup and cook until they are clear. Pack boiling hot in jars and seal.

**(111) Chowchow.<sup>1</sup>**

1. Take and cut in moderate sized pieces:
  - 2 qts. of small cucumbers
  - 2 " " " onions
  - 2 " " " green tomatoes

<sup>1</sup> From Connecticut Agricultural College Emergency Food Series No. 21.

- 1 cup salt
- $\frac{1}{4}$  lb. ground mustard
- 3 cups of sugar
- 2 " " flour
- 2 qts. of string beans
- 2 large cauliflowers
- 6 green peppers
- 3 red peppers
- 2 tablespoonfuls ground turmeric
- 4 qts. of cider vinegar
- 1 bunch of celery

2. Remove seeds from peppers. Sprinkle with 1 cupful of salt and add water to cover. Let stand 24 hours. Place onions in separate salt water to stand likewise.

3. Drain water from onions and scald all vegetables in the water in which the peppers have stood and allow to drain.

4. Make a paste of mixing the mustard, turmeric, sugar and flour with a little cold vinegar, afterwards adding the balance of the vinegar which has come to a boil.

5. Stir for a few minutes to a smooth consistency, then pour over the drained vegetables and cook slowly on the back of the stove for 20 min. Pack hot in jars and seal.

#### (112) Mustard Pickles.

1. Place in a brine of  $\frac{1}{2}$  cup of salt per quart of water the following vegetables and let stand overnight:

- 1 pint whole small cucumbers
- 1 " sliced cucumbers
- 1 " whole small onions
- 1 cup of string beans broken into lengths
- 3 green sweet peppers (chopped)
- 3 red " " "
- 1 pint small green tomatoes cut in half
- 1 " of cauliflower

2. Freshen in clear water. Allow to stand in a mixture

of water and vinegar equal parts. Then scald in the same liquid.

3. Prepare a mustard dressing of 1 qt. of vinegar, 4 tablespoonfuls of flour, 1 cup of sugar, 3 tablespoonfuls of powdered mustard,  $\frac{1}{2}$  tablespoonful of celery seed. Rub all the dry ingredients together first; heat the vinegar to boiling and add slowly to the dry ingredients, working them into a fine paste. Cook in a double boiler until the sauce thickens.

4. Add the hot sauce to the pickles and heat to simmering. Pack hot in jars. Place the jars in a washboiler sterilizer. Sterilize 15 min. at 212° F. and seal.

**(113) Piccalilli.**<sup>1</sup>

1. Use 8 qts. green tomatoes, 2 or 3 green sweet peppers and 2 hot peppers. The tomatoes may be chopped or sliced in  $\frac{1}{2}$  in. pieces. Soak the tomatoes and chopped peppers overnight in 1 pint of salt and water to cover. Drain thoroughly.

2. Heat until tender in the following mixture:

- 3 qts. vinegar
- 4 cups of sugar
- 1 teaspoonful ginger (ground)
- 1 " " cinnamon (ground)
- 2 tablespoonfuls mustard (ground or whole).

3. Add 1 cup of grated horseradish. Heat to boiling and seal. Allspice, cloves, and 1 qt. of chopped onions may be added before cooking.

**(114) Chili Sauce.**<sup>1</sup>

1. Take the following ingredients.
  - 2 qts. of ripe tomatoes (peeled)
  - 4 green sweet peppers
  - 4 tablespoonfuls brown sugar
  - 1 hot pepper
  - 4 onions

<sup>1</sup> From Circular 35, Agricultural Extension Service, University of Missouri, by Carrie L. Pancoast.

- 1 tablespoonful ginger
- $\frac{1}{2}$  teaspoonful nutmeg
- 2 tablespoonfuls salt
- 1 teaspoonful cinnamon

2. Chop the vegetables, add the other ingredients and cook till tender ( $1\frac{1}{2}$  hours). Then add 3 cups of vinegar, boil 5 min. and seal hot in jars.

**(115) Dixie Relish.<sup>1</sup>**

1. Take

- 1 qt. chopped cabbage
- 1 pint chopped white onions
- 1 " " sweet red peppers
- 1 " " green " "
- 4 tablespoonfuls mustard seed
- 2 " celery " (crushed)
- $\frac{1}{2}$  cup of sugar
- 1 qt. of vinegar
- 5 tablespoonfuls salt

2. Soak the peppers in brine (1 cup of salt to 1 gal. of water), for 24 hours. Freshen in clear cold water for 1 to 2 hours. Drain well. Remove seeds and coarse white sections. Chop separately and measure chopped cabbage, peppers, and onions before mixing. Add spices, sugar and vinegar. Let stand overnight covered in a crock or enameled vessel. Pack in small sterilized jars as follows. First drain off the vinegar so jar may be well packed. Pack the relish in the jars, pressing it carefully; then pour over it the vinegar which was drained off. Paddle the jar thoroughly to get every bubble out and allow the vinegar to displace all air spaces. Garnish each jar with two quarter-inch pointed strips of red pepper 3 inches long, placing these strips vertically on opposite sides of the seams of the jar.

3. Place in a washboiler sterilizer with caps and rub-

<sup>1</sup> Recipe published by Sadie R. Guseman of West Virginia Agricultural Experiment Station.

bers on loosely. Heat the water to boiling and boil 10 min. Remove and seal. (See Fig. 15 for diagram of the washboiler sterilizer.)

**(116) Chutney.<sup>1</sup>**

1. Mix the following ingredients:

- 12 apples finely chopped
- 6 green tomatoes finely chopped
- 6 small red peppers finely chopped
- 2 " onions " "
- 1/2 cup mint leaves
- 4 tablespoonfuls salt
- 1 " white mustard seed
- 2 cups of sugar
- 2 " " raisins finely chopped
- 2 " " vinegar
- 1/4 cup lemon juice

2. Seal cold or let stand in a cool place in earthen or glass jar. No sterilization is necessary.

**(117) Pickled Sweet Peppers.**

1. 12 green or ripe sweet peppers (whole)

- 2 qts. cabbage
- 4 tablespoonfuls white mustard seed
- 3 " celery seed
- 4 sweet peppers chopped
- 1 hot pepper "
- 1/2 cup of sugar

2. Remove stems and seeds from sweet peppers. Soak overnight in brine (1 cup of salt to 1 gal. of water).

3. Chop the cabbage and the 4 sweet peppers separately, add 1 tablespoonful of salt to each and let stand overnight. Drain. Mix with the other ingredients and stuff the peppers.

4. Place the stuffed peppers in jars, cover with hot vinegar and seal.

<sup>1</sup> From Circular 35, Extension Service, University of Missouri Experiment Station, by Carrie L. Pancoast.

**(118) Green Tomato Pickle.<sup>1</sup>**

1. 1 gal. green tomatoes
- $\frac{1}{2}$  doz. large onions
- 3 cups of brown sugar
- $\frac{1}{2}$  lemon
- 3 pods of red peppers
- 3 cups of vinegar
- 1 tablespoonful whole black pepper
- 1       "       "       cloves
- 1       "       "       allspice
- 1       "       celery seed crushed
- 1       "       mustard seed
- 1       "       ground mustard

2. Slice the tomatoes and onions very thin. Sprinkle over them  $\frac{1}{2}$  cup of salt and let stand overnight in a crock or enameled vessel. Drain well.

3. Tie the pepper, cloves, allspice, and celery seed in a cheesecloth bag. Slice the lemon and chop 2 pepper pods very fine. Add all seasoning except one pepper pod to the vinegar, then add the drained tomato and onions.

4. Cook for  $\frac{1}{2}$  hour, stirring gently at intervals to prevent burning. Remove spice bag to prevent darkening of the product. Pack hot in small jars and garnish with slender strips of the red pepper, placing them vertically on opposite sides of the jar.

5. Place covers and rubbers on jars loosely and process 15 min. at 212° and seal. (See Fig. 15.)

**(119) Tomato Ketchup.<sup>2</sup>**

1. Select ripe tomatoes of deep red color. Cook the tomatoes thoroughly and put through a colander or sieve to remove seeds and skins.

<sup>1</sup> From Extension Circular 35, University of Missouri College of Agriculture by Carrie L. Pancoast.

<sup>2</sup> Published by Sadie R. Guseman of West Virginia University.



2. For each gallon of the pulp so obtained use:
  - 2 tablespoonfuls of salt
  - 4        "        "        sugar
  - 1        "        powdered mustard
  - 1        "        whole cloves
  - 1        "        allspice
  - 1        "        cinnamon
  - 1        "        pepper
  - 2 small red peppers cut finely
  - 1 pint of vinegar (preferably cider vinegar)
  - 4 tablespoonfuls ground paprika (not essential but desirable)

Tie the whole spices in a bag of cheesecloth and add the other ingredients, except the vinegar. The paprika gives a bright red color and flavor, but may be omitted.

3. Cook until almost thick enough (usually  $1\frac{1}{2}$  hours), and add the vinegar. Continue cooking till thick.

4. Pour hot into scalded bottles and cork with corks sterilized in boiling water 10 min. The corks are not pressed in at first but left loosely in the necks of the bottles.

5. Put the bottles upright in a washboiler sterilizer with hot water one-half way up the bottles. Heat water to boiling and boil 1 hour with cover on the boiler. Drive corks into the bottles. Allow to cool. Seal with paraffin or wax.

#### (120) Tomato Paste.

No vinegar is used for this product but it is given here in conjunction with tomato ketchup.

1. Boil ripe red tomatoes until soft. Pass through a screen to remove seeds and skins.

2. Boil down quickly on a stove to about the consistency of thick ketchup. Then place it on the back of the stove or better in a double boiler and cook down until it is as thick as thick peanut butter.

3. Pack hot in jars or cans.

4. Sterilize 1 hour at 212° F. in a washboiler sterilizer and seal. This product can be used as a flavoring for various dishes, that is, macaroni, stews, rice, beans, etc., in the same way that canned tomatoes are used. It may be flavored by adding a button of garlic, a tablespoonful of cayenne pepper and two sweet red peppers and salt to taste per gallon of pulp before cooking. Then when thick, a little olive oil may be beaten in before packing in jars or cans. This product is also known as tomato "conserva" by the Italians. It is used by them in great quantities.

**(121) Ripe Olives.**

1. *Varieties.* Olives for pickling are grown extensively in California and to a slight extent in Arizona. These are the only two states of the United States that grow them. The most popular variety is the Mission olive and the next popular the Manzanillo. Practically no others are used for ripe pickles.

2. Choose olives that have become red to black in color. Underripe fruit gives a tough, inferior product; overripe fruit may be soft. Olives are exceedingly bitter and must be treated with lye to remove this.

3. Prepare a lye of 3 oz. of soda lye per gallon of water. This is 1 lb. per 5 gals. or about 3 tablespoonfuls per gallon.

4. Place the olives in a stoneware crock or glass jar or wooden vessel. Do not use metal. Cover thoroughly with the lye. Stir frequently.

5. Once every hour remove two or three olives and cut in half. Note whether the lye has penetrated through the skin. This can be determined by the fact that the lye will change the color of the skin and flesh of the olive.

6. When the cutting test shows that the lye has penetrated the skins and a little way into the flesh of the olives, pour off the lye into another vessel (usually the lye will penetrate in 3 to 4 hours).

7. The olives are now exposed to the air in the vessel in which they were treated. Stir twice daily and leave exposed until they are black or dark in color. This will take from 1 to 5 days. The exposure is to bring back the color removed by the lye treatment.

8. Return the used lye to the olives and leave until the lye has reached the pits of the olives, as indicated by cutting a sample to the pit with a sharp knife. Eight to 12 hours' time will usually be required.

9. Pour off the lye. Cover the olives with water. Change the water twice daily until there is no longer any taste of lye. This will usually require 1 week.

10. Make a brine of 5 oz. (5 tablespoonfuls), of salt per gallon of water. Cover the olives with this and heat to boiling. Pack hot in jars or cans. Sterilize 1 hour at 212° F. and seal (see Fig. 15 for appearance of a wash-boiler sterilizer).

### (122) Green Olive Pickles.

1. *Varieties.* The Sevillano and Ascolano olive are usually employed because of their large size. Mission and Manzanillo may also be used.

2. Pick the olives when full size but hard green.

3. Prepare a lye of 3 oz. of soda lye per gallon of water. (1 lb. per 5 gals.). Place the green olives in this and leave until the lye reaches the pits; as indicated by cutting a sample to the pit. It will take the lye about 24 hours to reach the pit.

4. Pour off and discard the lye. Cover the olives with water. Change this twice daily until the lye is all removed; about 1 week.

5. Prepare a brine of 9 oz. of salt per gallon of water (a little more than  $\frac{1}{2}$  lb. per gallon). Pack the olives in a keg or barrel or glass jar. Fill completely with the brine and drive bung into keg or barrel or seal the jar. Leave in a quiet place until the proper flavor develops. This will be in about 2 months.

6. Pour off the brine and strain it. Pack the olives in jars. Heat the brine to boiling and fill the jars with the boiling hot brine. Seal. No further treatment is necessary.

**(123) Ripe Olive Paste.**

1. Pickle ripe olives as in Recipe 121. Pit the olives with a cherry pitter. Grind them to a paste in a food grinder or sausage grinder. Flavor with salt, red pepper, chopped green chili and paprika to taste.

2. Pack the paste in small jars. Sterilize  $1\frac{1}{2}$  hours at  $212^{\circ}$  F. in a washboiler or similar sterilizer and seal.

**(124) Ripe Olives Cured by the Salt Process.**

1. Choose black ripe olives. Weigh. For each 4 lbs. of olives weigh 1 lb. of salt.

2. Mix the olives and salt thoroughly in crock or wooden vessel. Cover with a layer of salt. Leave until the olives have lost most of their bitterness; about a month or six weeks. They will be shrivelled in appearance. Brush off the salt and dip in olive oil. Pack in jars. Do not sterilize. These olives will have a slight bitter flavor and more "olive" flavor than olives pickled by the lye process. They are used extensively in Europe and in America by Italians and Greeks. This process was used by the ancient Romans and Jews.

**(125) Dessicated Olives.**

1. Pickle ripe olives as directed in Recipe 121.

2. Place in a slow oven and dry. The olives will first shrivel and become hard. Heat them until they swell again to their original size. These olives will be dry and very light and porous. They are an excellent "between meal" morsel.

## CHAPTER XXXIV

### RECIPES FOR THE HOME PRESERVATION OF MEATS AND EGGS

The meat preservation recipes given in this chapter (with the exception of the fish preservation recipes), were taken from Farmers' Bulletin 183, written by A. Boss. The fish preservation recipes were furnished by H. Davi, at present with the Bureau of Chemistry of the U. S. Department of Agriculture.

#### Recipes for Home Curing of Meats.<sup>1</sup>

##### (126) Plain Salt Pork.

1. Prepare a clean hard wood barrel by thoroughly scrubbing the inside with hot water and washing soda or a little lye and rinsing thoroughly with water. Sirup barrels, alcohol or whisky barrels that are still sound and sweet may be used. A large stoneware crock is also suitable.

2. The meat must be properly and thoroughly cooled because if salted before the animal heat is out the shrinkage of the muscles cause the retention of injurious gases, giving an offensive odor to the meat. It must not be frozen because the salt will then not penetrate. Ordinarily 24-36 hours' cooling after slaughtering will be sufficient.

3. Cut the carcass in pieces about 6 in. square. Rub each piece with fine salt and pack closely in a barrel. Let stand overnight.

4. The next day weigh out 10 lbs. of salt and 2 oz.

<sup>1</sup>The recipes for the curing of pork and beef were taken from Farmers' Bulletin 183, U. S. D. A., by Andrew Boss.

of saltpeter to each 100 lbs. of meat and dissolve in 4 gals. of water. Allow this brine to cool thoroughly.

5. Cover the pork completely with this cold brine and weight it down with stones or other heavy weights to keep it completely immersed. The pork should be kept in the brine till used.

### (127) Corned Beef.

1. Cool the carcass thoroughly but do not allow it to freeze. Cut in pieces about 5 or 6 in. square. The cheaper cuts such as plate, rump, cross ribs, brisket, etc., are ordinarily used. Fat beef gives better results than too lean meat.

2. Weigh the cut meat carefully and allow 8 lbs. of salt to each 100 lbs. of meat. Sprinkle a layer of salt  $\frac{1}{4}$  in. thick in the bottom of the barrel. Pack in as closely as possible the cuts of meat, making a layer 5 or 6 in. thick. Then put on a layer of salt, following that with another layer of meat. Repeat until the meat and salt have all been packed into the barrel, care being used to reserve salt enough for a good layer over the top.

3. After the package has stood overnight add for every 100 lbs. of meat, 4 lbs. of sugar, 2 oz. of baking soda, and 4 oz. of saltpeter dissolved in a gallon of tepid water. Three gallons more of cold water should be enough to cover this quantity. In case more or less meat is to be corned, make the brine in the proportion given.

4. A loose board weighted down with a heavy stone or other weight should be put on the meat to hold it down under the brine.

5. In warm weather the brine may become slimy orropy. If this happens make a new brine of 8 lbs. of salt, 4 lbs. of sugar, 2 oz. of baking soda, and 4 oz. of saltpeter to 4 gals. of water. Pour off the old brine and wash the meat thoroughly. Add the new brine. If the meat

is kept a long time the brine should be changed occasionally. The meat will usually be corned and ready for use in 6 weeks.

**(128) Sugar Curing Hams and Bacon for Smoking.**

1. Cut bacons in proper sizes and trim hams and shoulders after meat has cooled. Weigh.

2. Then pack in a barrel with the hams and shoulders in the bottom, using strips of bacon to fill in between or to put on top.

3. Weigh out for each 100 lbs. of meat, 8 lbs. of salt, 2 lbs. of brown sugar and 2 oz. of saltpeter. Dissolve all in 4 gals. of water and cover the meat with the brine. For summer use it will be safer to boil the brine and allow it to cool before using. Place a few pieces of board on the meat with weights to keep the meat immersed in the brine.

4. Bacon strips should remain in the brine 4 to 6 weeks and hams 6 to 8 weeks before smoking. In case the brine becomes slimy or ropy remove it, wash the meat and cover with a fresh brine made as above.

**(129) Dry Curing of Pork for Smoking.**

1. Cut bacons to proper size and trim hams and shoulders. Weigh.

2. For each 100 lbs. of meat weigh out 5 lbs. of salt, 2 lbs. of granulated sugar, and 2 oz. of saltpeter and mix them thoroughly.

3. Rub the meat once every 3 days with a third of this mixture. While the meat is curing it is best to have it packed in a tight box or barrel. For sake of convenience it is advisable to have two barrels and to transfer the meat from one to the other each time it is rubbed. After the last rubbing the meat should be let lie in the barrel a week or ten days, when it will be cured and ready to smoke. It cures best in a cool moist place; and the preservatives will not penetrate satisfactorily in a dry warm place.

**(130) Salting Beef for Drying.**

1. The round is usually employed. Cut the fresh meat lengthwise of the muscle fibers so that the fibers will be cut crosswise later for table use, after drying. A tight jar or barrel is necessary for curing.

2. To each 100 lbs. of meat weigh 5 lbs. of salt, 3 lbs. of sugar, and 2 oz. of saltpeter. Mix thoroughly.

3. Rub the meat with a third of the mixture and pack tightly in a large jar or cask. Allow to remain 3 days. Remove and rub with a third of the mixture. In re-packing, put at the bottom the pieces that were on top during the first salting. Rub again with remaining third of the mixture. Let stand 3 days. It is then ready for smoking and drying. The brine forming after each salting should not be removed but the meat should be repacked in the liquid each time.

**(131)<sup>1</sup> Preservation of Fish by Salting.**

1. Select fish that are fresh.

2. For large fish such as salmon and shad, cut off the head; scale, split in two down the back and remove backbone and visceral matter. Clean fish thoroughly. In splitting the fish two pieces very much alike will be obtained. Make three or four straight incisions on the outside of each piece so that the salt will penetrate. Then cut the two pieces in half crosswise making four pieces for each fish.

3. Make up a saturated brine so that it registers 95° on the salometer or simply prepare a brine of 3 lbs. of salt per gallon of water.

4. Immerse the fish in the brine. Leave immersed 48 hours. A wooden weight should be used to keep the fish completely submerged.

5. Remove the fish and drain thoroughly 3 to 4 hours. Use 5 or 10 gal. kegs for packing. Place the fish in the bottom of barrel on layer of salt with flesh side of fish

<sup>1</sup> The Fish Recipes were given by H. Davi.



upward. Sprinkle with a layer of salt. Add another layer of fish; then another layer of salt and so on until the keg is full. Cover with a thin layer of salt. Cut a circular false head to fit inside the barrel and weight it down heavily.

6. After a month drain off the oily liquid and replace with a saturated brine of 3 lbs. of salt per gallon of water. Weight down again and examine occasionally. The fish is ready for use in 5-6 months. Crocks may be used instead of barrels, but barrels seem to give a better flavor.

7. *Small Fish.* Small fish such as herring, anchovy, mackerel, and sardines are not cleaned. Immerse in saturated brine of 3 lbs. salt per gallon for 24 hours. Then proceed as directed for large fish by packing in dry salt.

8. *Salt.* The salt used should be granular, not too fine.  
**(132) Home Made Smokehouse.**

A good form of smokehouse is shown in Fig. 56. It can be made of any size. If a very small one is to be made, a large dry goods box or an old barrel may be used. It should be so arranged that the pieces of meat will hang clear of each other and so that the smoke will pass freely around the pieces. The smoke should be generated outside the house and conducted to the bottom of the house by means of an old stovepipe or covered ditch. If a larger house is built it should be 8 to 10 ft. high. One 6 x 8 ft. will be large enough for ordinary farm use. Ample ventilation should be arranged to carry off the heat. Small openings under the eaves or a chimney in the roof will be sufficient, arranged so that they may be controlled. A fire pot should be built outside the house and the smoke conducted into the house by means of a flue made of stovepipe or wood. If the meat hangs 6 or 7 ft. from the floor a fire may be built on the floor of the house itself.

**(133) Fuel for Smoking.**

Green hickory or maple smothered in sawdust of the same wood are considered excellent for smoking pork and beef. Any hard wood is superior to soft wood. Corn cobs may be used but give off carbon that may darken the meat. Spent tan bark from tanneries is the best material for smoking fish. It is also very good for other meats. The wood should *smolder* and *smoke* and not burst into *flame*.

**(134) Ham and Bacon.**

1. Cure the ham in brine or salt as described in Recipes 130 and 131. Rinse off adhering salt and allow to drain. Hang in the smokehouse.

2. Smoke continuously for 2 or 3 days or smoke 3 or 4 hours each day for about 2 weeks. Use hard wood or spent tan bark for smoke.

3. As soon as the meat is sufficiently smoked, open the doors and windows of the smokehouse and allow meat to cool. When thoroughly cooled, remove and wrap each piece closely in paper. Put the wrapped pieces in strong sacks and tie well at the top. The sacks should be hung where they are to remain until the meat is used. The sacks should be coated with a thick paste of lime, water and enough glue to make the mixture stick. Do not stack in piles. Hang so pieces do not touch.

**(135) Dried Smoked Beef.**

1. Prepare the beef by salt curing according to Recipe 132. Rinse off adhering salt and hang in smoke house. Allow to drain several hours.

2. Smoke for about 3 days. Then hang in the kitchen or a dry attic and allow to dry until sufficiently dry for slicing.

**(136) Smoking Large Fish.<sup>1</sup>**

1. Use fresh fish only. Scale. Clean. Cut in half

<sup>1</sup> The Fish Recipes were given by H. Davi.

down the back and remove backbone. Cut in pieces about 6 in. long.

2. Prepare a saturated solution of salt (3 lbs. per gallon of water). Place fish in this brine for 24 hours, keeping them immersed by wooden floats.

3. Remove from brine and allow to drain 4 hours.

4. Construct a smokehouse as previously described but make a number of wire netting trays that may be supported in some way in the smokehouse. They may be supported on cleats, nailed to the sides of the house if it is small, or by wires from the rafters if the house is large. A number of trays may be placed one above the other if a space of a few inches is allowed between each pair. Lay the fish on these wire netting or wire screen trays.

5. Smoke the fish 10 to 12 hours with tan bark smoke. Obtain this from a tannery. If this cannot be obtained use any hard wood chips smothered in hard wood sawdust.

6. Remove the fish and dry in the sun 3 to 5 days. If the sun is not shining, dry in a very slow oven or any form of fruit dryer. (See descriptions of artificial dryers, Chap. XII, par. 68.) Wrap in paraffined paper and pack in boxes in a cool dry place.

### (137) Smoking Small Fish.

1. Cut off heads. Scale and clean. Split so that halves just hold together.

2. Store in brine of 3 lbs. salt per gallon of water for 20 hours. Remove and drain 4 hours.

3. Smoke 8 hours, using spent tan bark if obtainable.

4. Dry in the sun 2 to 3 days, or in artificial dryer. Wrap in paraffined paper and pack.

### (138) Drying Fish.

1. Place the fish in a brine of 3 lbs. of salt per gallon of water as directed in Recipe 133. Drain 5 hours.

2. Dry several days in the sun or in artificial evaporators until most of the moisture is removed. Wrap in

paper or press into bricks and wrap. Store in dry place.

**(139) Dried Beef and Venison (" Jerkey ").**

This can only be made in a dry arid climate.

1. Cut in strips about 2 in. wide and  $\frac{1}{2}$  in. thick. Rub with a little salt and sprinkle heavily with pepper to repel insects.

2. Hang strips on a clothesline or long wire or string in the sun till dry. Pack in sacks.

**(140) Preservation of Eggs in Water Glass.**

1. To each pint of water glass obtained from a grocery or drug store, add 9 pints of water. Pack the eggs in a stoneware crock, tin can, or wooden vessel. Fill with the water glass and cover to prevent evaporation. Store in a cool place.

2. *Alternative Method.* Prepare a solution of 1 cup of water glass to 2 cups of water. Dip the eggs in this solution and allow to dry on a layer of flour or bran. Dip again the next day and allow to dry as before. Pack in bran and store in a cool place. Or pack in dry salt. This is preferable to bran.

3. *Caution.* Use only fresh eggs and if possible non-fertile eggs. In method (2) use clean, very dry bran.

**(141) Preservation of Eggs in Lime and Salt.<sup>1</sup>**

1. Slack 2 lbs. of lime in a small quantity of water. Mix with 2 gals. of water and add 1 lb. of salt. Stir thoroughly and allow to settle.

2. Pour off the clear solution and use it for the preservative. This will be sufficient for about 12 doz. eggs.

<sup>1</sup> This method is given by J. B. Hayes and F. E. Mussehl in Circular 74, Agricultural Extension Service, University of Wisconsin.

## CHAPTER XXXV

### RECIPES FOR DAIRY PRODUCTS

Most dairy products are best made on a factory scale. This is especially true of cheese. For this reason only one recipe for hard cheese has been given. This recipe has been recommended by the University of Minnesota Experiment Station as being the most suitable for farm use. The recipe given for cottage cheese is one of the most approved and easily followed. Recipe 146 deals with the preservation of butter by salting.

#### (142) Gouda Cheese.<sup>1</sup>

This cheese is made from whole sweet milk. One hundred pounds of milk will make 10 lbs. of finished cheese. It is best adapted to home manufacture of the 100 varieties of cheese on the American market. No special equipment is necessary.

1. *The Tools.* An ordinary washboiler serves very well as a vat. The curd may be heated by placing the boiler on the edge of the kitchen stove. The curd is best cut with many bladed knives called curd knives, made for the purpose, one with vertical and one with horizontal knives; but the cutting may be done with a common wire bread toaster or even with a coil of hay wire.

2. The wooden mold should be made like a strong box, about 10 x 8 in. inside measurement. The top and bottom should be loose and small enough to fall down through the mold; or in other words, to follow down when the cheese is pressed.

The press is made of a cleat nailed against the wall, a box in front, and a 2 x 4 or pole 10 or 12 ft. long for a lever. A pail of stones makes an excellent weight.

<sup>1</sup> R. M. Washburn. Special Bul. 12, Agr. Extension, Univ. Minn.

An accurate thermometer is needed for uniform work. The floating dairy kind is most convenient, but an ordinary weather thermometer may be used.

3. *The Milk.* The best cheese is made from clean, fresh, morning's milk, before it is 4 hours old. If night's milk is used it should either be made up at once or be thoroughly cooled after milking. Milk that is even slightly turned will make a quick acting, hard, dry cheese. If the milk is not clean or is too old the cheese is likely to become gassy and ill flavored.

4. *The Rennet.* The most practical rennet for farm use is that in tablet form, obtainable from any creamery supply company. One No. 2 fresh rennet tablet will thicken 12 gals. or 100 lbs. of milk. When the tablets are old, more must be used. Just before being used, the tablets should be dissolved at the rate of 1 tablet per pint of cold water. Hot water will kill the rennet. Rennet is improved by an ounce of salt to a pint of water, especially if it must be held for several minutes after being dissolved.

5. *Heating.* Heat the milk in the washboiler to 88° F.; not over 90° F. and not under 86° F.

6. *Setting.* The rennet solution at the rate of 1 tablet per 12 gals, is then added and thoroughly stirred for 2 min. The surface should be stirred for another 2 min. to prevent the cream from separating from the milk and being lost.

7. *Holding.* The mixture is then covered and allowed to stand at 88° F. until the curd has become thick. This should require not less than 12 nor more than 18 min.

8. *Cutting.* The curd is ready to cut when it has coagulated enough to cause it to break clear over the forefinger when the finger is inserted into the curd at an angle of 45°, lifted upward and touched on the top of the thumb. The curd is cut into small cubes to allow the whey to escape more quickly and perfectly. Therefore

the curd lumps or cubes should be cut in uniform size and about one-third of an inch across.

9. *Stirring.* Stirring is necessary to obtain a uniform removal of the whey as the curd continually settles and mats into large masses unless broken up by hand or by a small rake. The curd should be stirred gently at intervals until it is sufficiently cooked.

10. *Heating.* After the cutting and the first thorough stirring, the curd should be slowly heated to about 100° F. This may be done by edging the boiler back on the stove or by pouring clean hot water directly into the boiler or vat. The whey may be dipped off and more hot water added until the desired temperature is reached.

11. *Dipping and Draining.* When the curd has become so firm that a handful firmly squeezed, will fall apart when released, it is ready to be removed and put to press. Draining can be done by straining through cheesecloth.

12. *Pressing.* When the whey and water have been drained off, the granules of curd are firmly pressed into the mold or form. If the wooden form is used, a clean piece of cheesecloth should be first laid over and pressed down into the box and then the curd pressed into all corners. When the form is filled the cloth should be folded over it, the follower head inserted, and the whole put to press, first with little pressure and later with more. If the metal form is used, the curd is first pressed in without the cloth to permit the water to escape promptly, but upon being dressed it is covered with thick, firmly woven cloth bandages.

13. *Dressing.* After the cheese has been pressed for an hour or two it should be taken out and turned over in the form, all wrinkles in the bandage being smoothed out. It should then be returned to the press and should remain under heavy pressure for half a day or even until

the next morning, when it should be taken out and put into salt as directed in the next step.

14. *Salting*. Salting is best done by floating the young cheese in brine made as strong as possible ( $3\frac{1}{2}$  lbs. of salt per gallon of water). Dry salt is sprinkled on the top of the cheese and every 12 hours the cheese is turned over in the water and resalted. This is continued from 30 to 40 hours. It is then wiped dry and stored in a cool place.

15. *Paraffining*. By the old system the cheese was greased to keep the moisture in and rubbed firmly by hand every day to keep off mold, but a better way is to allow the cheese to become slightly dry and then dip into hot paraffin. A kettle filled with water, with half an inch of paraffin on the water, brought to a boil, makes an excellent paraffining tank. If the paraffin is too hot, it will draw the fat out of the cheese and will not cling well. If the cheese is too moist the paraffin will not cling well. Melted paraffin may also be painted on the cheese.

16. A cellar or other fairly cool place is best for curing. If too warm, the cheese will ripen too fast and may develop an off flavor, while if too cold it will work too slowly. A temperature of about 60° F. is very good. Cheese made in this way should be ready to eat in from three to eight weeks. It should keep for six months or more.

#### (143) Cottage Cheese.

1. *Souring the Milk*. Allow sweet clean milk to stand in a warm kitchen until thick and "clabbered."

2. *Cutting*. Cut in small cubes with a case knife. In making large quantities it is well to use regular curd knives. Allow to stand undisturbed for several minutes or until the whey has been fairly well forced out.

3. *Heating*. Heat with gentle stirring to 93–98° F. Allow to stand at this temperature until it is fairly firm to the touch. Then it should be drained.



4. *Draining.* Pour into a bag of cheesecloth and allow to drain an hour or two.

5. *Finishing.* Add salt to taste. Cream may be added if desired and also white pepper. Chopped pimentoes or red peppers may be added. Paprika may also be used and adds very much to the flavor. Mix with a large spoon or silver fork. The cheese should be used the day on which it is made.

**(144) The Preservation of Butter by Salt.**

1. *By Dry Salt.* Use fresh sweet butter. Weigh carefully. Weigh 1 lb. of salt for each 10 lbs. of butter. Work it in thoroughly. Pack tightly in crocks and cover with salt. Store in a cold place. When the butter is to be used, freshen it by working it in cold water.

2. *In Brine.* To each 10 lbs. of butter, add  $\frac{1}{2}$  lb. of salt and work in thoroughly. Make a brine of  $3\frac{1}{2}$  lbs. of salt per gal. Pack the butter down in this brine and store in a cool place. Keep the butter immersed in the brine with weights if necessary. Before use, freshen by working in cold water.



## APPENDIX

### Hydrometer Table for Salt, Sugar, and Lye Solutions

The following table can be used to find the equivalents of the various systems used in measuring the amounts of salt, sugar, and lye in water solutions. The table is also valuable for use in the preparation of solutions of these substances of desired strengths. For example: Suppose a 5% salt solution is desired. Six and seven-tenths (approximately  $6\frac{3}{4}$ ) oz. of salt would be added to each gallon of water; this figure being found by consulting the figure in column 3 under "Ounces per Gallon," opposite 5 in column 2.

If a Baumé hydrometer is in use, the corresponding Balling degrees or per cent sugar can be found in column 4.

The table has been arranged by J. R. Zion of the University of California.

## Relation of Specific Gravity, Salt, Sugar and Soda Lye

RELATION OF SPECIFIC GRAVITY, SALT, SUGAR, AND SODA LYE

<i>Specific Gravity</i>	<i>Salt</i>		<i>Sugar</i>		<i>Soda Lye</i>	
	<i>Baumé or Per Cent Salt</i>	<i>Oz. per Gal.<sup>1</sup></i>	<i>Balling or Per Cent Sugar</i>	<i>Oz. per Gal.<sup>1</sup></i>	<i>Per Cent</i>	<i>Oz. per Gal.<sup>1</sup></i>
1.007	1	1.3	1.8	2.3	0.5	0.7
1.014	2	2.6	3.6	4.8	1.2	1.5
1.022	3	4.0	5.5	7.5	1.8	2.4
1.029	4	5.3	7.2	9.9	2.5	3.2
1.036	5	6.7	9.0	12.6	3.1	4.1
1.045	6	8.1	10.8	15.5	3.7	5.0
1.052	7	9.6	12.6	18.5	4.5	6.0
1.060	8	11.1	14.5	21.7	5.2	7.0
1.067	9	12.7	16.2	24.7	5.8	8.0
1.075	10	14.2	18.1	28.3	6.6	9.0
1.083	11	15.8	19.8	31.6	7.3	10.1
1.091	12	17.5	21.7	35.5	8.1	11.3
1.100	13	19.1	23.5	39.3	8.8	12.4
1.108	14	20.8	25.3	43.3	9.5	13.5
1.116	15	22.6	27.2	47.8	10.3	14.7
1.125	16	24.4	29.1	52.5	11.1	15.9
1.134	17	26.2	30.9	57.2	11.9	17.3
1.142	18	28.1	32.7	62.2	12.7	18.6
1.152	19	30.0	34.6	67.7	13.5	19.9
1.162	20	32.0	36.5	73.6	14.3	21.3
1.171	21	34.0	38.3	79.5	15.1	22.7
1.180	22	36.1	40.1	85.7	16.0	24.2
1.190	23	38.2	42.0	92.7	16.9	25.7
1.200	24	40.4	43.9	100.2	17.8	27.3
1.210	25	42.7	45.9	108.6	18.7	29.0
1.220	26	45.0	47.7	116.7	19.6	30.7
1.231	27	47.3	49.6	126.0	20.6	32.5
1.241	28	49.8	51.6	136.5	21.5	34.2
1.252	29	52.3	53.5	147.3	22.5	36.1
1.263	30	54.9	55.4	159.0	23.5	38.0
1.274	31	57.5	57.3	171.8	24.5	39.9
1.285	32	60.2	59.3	186.5	25.5	41.9
1.297	33	63.0	61.2	201.9	26.6	44.1
1.308	34	66.0	63.2	219.8	27.6	46.3
1.320	35	68.0	65.2	240.0	28.8	48.7
1.332	36	72.0	67.2	262.2	30.0	51.1
1.345	37	75.2	69.2	287.6	31.2	53.7

<sup>1</sup> Ounces of material to be added to one gallon of water.

### Formula for Soldering Fluid

Place granulated zinc in an open glass fruit jar or other open glass container and add approximately three times its volume of strong muriatic (hydrochloric) acid and allow to stand for about one hour. Strain off the solution from the undissolved zinc through a cloth. Add an equal volume of water to the solution. It is then ready to use. It may be used repeatedly until it becomes too weak to act satisfactorily.

### Labeling Laws

Most states have enacted laws that make it compulsory to state on the label in prominent sized type the net contents of all cans, bottles, and other packages containing foods offered for sale. The net contents are to be indicated in ounces or pounds if the food is solid: and as fluid ounces, pints, quarts, or gallons if the product is liquid. By measuring or weighing the contents of several of the containers after they have been processed, etc., a safe minimum for the net contents may be established and labels designed accordingly.

The label must also state plainly the kind of product in the container and the contents must correspond to this declaration. Adulterants, antiseptics, or artificial colors if used, must also be declared on the label.

If these points are borne in mind, no trouble with the pure food authorities will arise from the sale of good grades of home prepared food-stuffs.

### Federal Standards for Vinegar U. S. D. A.

"1. Vinegar, cider vinegar, apple vinegar, is the product made by the alcoholic and subsequent acetous fermentations of the juice of apples; is laevo rotary, and contains in one hundred cubic centimeters not less than four (4) grams of acetic acid, and not less than one and six-tenths

grams of apple solids, of which not more than fifty (50) per cent are reducing sugars.

2. Wine vinegar, grape vinegar, contains in one hundred cubic centimeters not less than four (4) grams of acetic acid, and not less than one gram of grape solids."

*Note:* Four grams acetic acid per one hundred cubic centimeters corresponds to 40 grains on the Leo Acid Tester. Vinegar for sale should test at least 45 on the Leo Tester.

### References on Home Canning

1. *Home Canning by the One-Period Cold-Pack Method.* O. H. Benson. Farmers' Bul. 839. U. S. D. A. 1917.
2. *Home Canning Fruits and Vegetables.* Ola Powell. Farmers' Bul. 853. U. S. D. A. 1917.
3. *Canning Vegetables in the Home.* J. F. Breazeale. U. S. D. A. Farmers' Bul. 359. 1909.
4. *Canning Peaches on the Farm.* H. P. Gould and W. F. Fletcher. Farmers' Bul. 426. U. S. D. A. 1915.
5. *Canning Tomatoes at Home and in Club Work.* J. F. Breazeale and O. H. Benson. Farmers' Bul. 521. 1916. U. S. D. A.
6. *Canned Fruits, Preserves, and Jellies.* Maria Parloa. Farmers' Bul. 203. U. S. D. A. 1904.
7. *Some Common Edible and Poisonous Mushrooms.* Flora W. Patterson and Vera K. Charles. Farmers' Bul. 796. U. S. D. A. 1917. (Contains Method of Canning.)
8. *Home and Farm Canning.* W. V. Cruess. Circular 158. University of California Experiment Station. 1917.
9. *Illustrated Food Preservation Leaflet. I. Canning Fruits and Vegetables.* W. V. Cruess. University California Experiment Station, 1917.
10. *A Canning Business for the Farm Home.* Claribel

- Nye and Bessie Austin. Cornell Reading Course, Vol. II, No. 47. 1913.
11. *Principles and Methods of Canning*. Cornell Reading Course, Vol. III, No. 69. Flora Rose and O. H. Benson. 1914.
  12. *Food Preservation: A National Challenge*. Cornell Reading Course. Lesson 113. June, 1917.
  13. *Canning, Preserving, Pickling*. States Relations Service. Doc. 22. Ext. S. No. A-81. U. S. D. A.
  14. *Canning Equipment*. Cornell Reading Course. Vol. III, No. 71. Sept. 1, 1914.
  15. *The Marketing of Country Club Products*. L. B. Flohr. Markets Doc. 5, Sept. 10, 1917. U. S. D. A.
  16. *National Canning Recipes*. Published by Northwestern Iron and Steel Co., Eau Claire, Wis.
  17. *Home Canning of Fruit and Vegetables*. Mary E. Cresswell. Georgia State College of Agriculture. Bul. 107. 1917.
  18. *Home Canning*. Anna M. Turley. Oregon Agr. College Extension Bul. 204. 1917.
  19. *Canning and Preserving with 4-H Recipes*. Extension Circular No. 11. (Revised.) North Carolina Agr. College. 1917.
  20. *Home Canning*. F. J. Crider. Bul. 26. Farmers' Reading Course of Clemson College, South Carolina. 1917.
  21. *Canning Fruits and Vegetables on the Farm*. C. C. Vincent. Idaho Expt. Station. Bul. 82, 1915.
  22. *Canning Fruits and Vegetables*. J. C. Price. Alabama Polytechnic Institute Extension Circular 12. 1917.
  23. *Home Canning*. F. E. Miller. Bul. 12. 1914. Virginia Truck Experiment Station.
  24. *Home Canning by the Cold Pack Method*. Naomi L. Newburn. Illinois Agr. Expt. Station Extension Circular 10, 1917.

25. *Home Canning*. Extension Circular No. 6. Vermont Agr. Extension Service. 1917.
26. *The Farm Vegetable Garden*. Leroy Cady (with chapter on Canning by R. S. Mackintosh). Ext. Bul. 17. Minnesota Agr. Expt. Station. 1916.
27. *Preservation of Fruits, Vegetables and Meats*. Gertrude McCheyne and J. C. Hogenson. Circular 18. Utah Agr. College.

### References on Commercial Canning

1. *Methods Followed in the Commercial Canning of Foods*. A. W. Bitting. U. S. D. A. Dept. Bul. 196. 1916.
2. *Preliminary Bulletin on Canning*. A. W. Bitting. Bul. 4. National Cannery Assn. Research Laboratory. 1915.
3. *Bulletins 1, 2, 3, and 5-14 of Research Laboratory of National Cannery Assn.* Washington, D. C.
4. *Sanitary Control of Tomato Canning Factories*. B. J. Howard and H. Stephenson. Dept. Bul. 539. U. S. D. A. 1917.
5. *Canning of Peas*. A. W. Bitting. Bul. 125. U. S. D. A. Bureau of Chemistry.
6. *Fruit and Vegetable Products*. C. I. Lewis and W. S. Brown. Oregon Agr. College Bul. 128. 1914.
7. *Art of Canning and Preserving*. J. Pacrette.
8. *American Commercial Methods of Manufacturing Preserves, Pickles, Canned Foods, etc.* C. A. Shinkle.
9. *Les Conserves de Fruits*. A. Rolet. Paris, 1912. (French.)
10. *Canning with Bacteriological Technique*. E. W. Duckwall. 1905.
11. *Western Canner and Dried Fruit Packer*. Chicago. (Journal devoted to Canning.)
12. *The Canning Trade*. Baltimore. (Journal on Canning.)



**References on Drying Fruits and Vegetables**

1. *The Evaporation of Fruits and Vegetables.* J. S. Caldwell. Bul. 148, Washington State Agr. Expt. Station. 1917.
2. *The Home Drying of Fruits and Vegetables.* J. S. Caldwell. Extension Bul. Series I, No. 27. Washington State Agr. Expt. Station. 1917.
3. *Evaporation of Apples.* J. S. Caldwell. Bul. 131, Washington State Agr. Expt. Station. 1916.
4. *Commercial Evaporation and Drying of Fruits.* J. H. Beattie and H. P. Gould. Farmers' Bul. 903. U. S. D. A. 1917.
5. *Drying Fruits and Vegetables in the Home.* Farmers Bul. 841. U. S. D. A. 1917.
6. *Home Drying Manual for Vegetables and Fruits.* 1917. Published by National Emergency Food Garden Commission 210-220, Maryland Bldg. Washington, D. C. 1917.
7. *Evaporation of Apples.* H. P. Gould. Farmers' Bul. 291. U. S. D. A. 1915.
8. *The Drying of Fruits and Vegetables.* Pearl MacDonald. Pennsylvania Expt. Station. Extension Circular 61. 1917.
9. *Drying of Fruits and Vegetables for Home Consumption.* North Carolina Extension Circular 50. 1917.
10. *Control of Dried Fruit Insects in California.* W. B. Parker. U. S. D. A. Dept. Bul. 235. 1915.
11. *Practical Methods of Drying Fruits and Vegetables.* Connecticut Agr. College Extension Service Form 67. 1917.
12. *Drying Fruits and Vegetables.* Addie D. Root. Missouri Agr. College Extension Circular 23. 1917.

### Fruit Juices

1. *Grape Juice*. F. T. Bioletti. Circular 108. University California Expt. Station. 1913.
2. *Manufacture of Unfermented Grape Juice in California*. W. V. Cruess and C. J. Hintze. Journal Industrial and Engineering Chemistry. April, 1914. Page 302.
3. *Home Uses for Muscadine Grapes*. Charles Dearing. Farmers' Bul. 859. 1917.
4. *Bottles for Fruit Juices*. (Reprint from Press Bulletin.) Connecticut Agr. College. 1917.
5. *Unfermented Apple Juice*. H. C. Gore. U. S. D. A. Bureau Chemistry Bul. 118. 1908.
6. *Manufacture and Use of Unfermented Grape Juice*. G. C. Husmann. U. S. D. A. Farmers' Bul. 644. 1915.
7. *Studies on Fruit Juices*. H. C. Gore. U. S. D. A. Dept. Bul. 241. 1915.
8. *Loganberry By-Products*. C. I. Lewis and F. R. Brown. Oregon Agr. College. Bul. 117. 1914.

### Sirups

1. *Sorghum Sirup Manufacture*. A. H. Bryan. U. S. D. A. Farmers' Bul. 477. 1912.
2. *The Production of Maple Sirup and Sugar*. A. H. Bryan. U. S. D. A. Farmers' Bul. 516. 1912.
3. *Sugar Beet Sirup*. C. O. Townsend and H. C. Gore. U. S. D. A. Farmers' Bul. 823. 1917.
4. *Fruit Products*. W. W. Chenoweth. Massachusetts Agr. College Extension Circular, 46, 1917.
5. *Muscadine Grape Sirup*. Charles T. Dearing. U. S. D. A. Farmers' Bul. 758. 1916.
6. *Apple Sirup and Concentrated Cider*. H. C. Gore. Year Book, separate 639. U. S. D. A. 1914.

### Jellies

1. *Principles of Jelly Making*. N. E. Goldwaithe. Bul. 31, University Illinois. Also Cornell Reading Course, Series No. 3, Vol. I, No. 15. 1912.
2. *Jellies and Marmalades from Citrus Fruits*. W. V. Cruess. Circular 146, University of California Expt. Station. 1916.
3. *Jellies, Jams, and Marmalades*. Connecticut College Emergency Food Series No. 17, 1917.
4. *Fruit Juices and Jellies*. W. V. Cruess. Illustrated Methods of Food Preservation. University of California Expt. Station. 1917.
5. *Jelly Investigations*. W. V. Cruess and J. B. McNair. Journal Industrial and Engineering Chemistry, p. 417, May, 1916.

### Vinegar and Pickles

1. *Vinegar from Waste Fruits*. W. V. Cruess. Bul. 287, University California Expt. Station. 1917.
2. *Grape Vinegar*. F. T. Bioletti. Bul. 227, University California Expt. Station.
3. *A Treatise on the Manufacture of Pure Apple Cider Vinegar by Quick Process*. Hydraulic Press Mfg. Co. Mt. Gilead, Ohio. Circular 22.
4. *Home Made Vinegar*. F. T. Bioletti and W. V. Cruess. Leaflet University California Expt. Station. 1917.
5. *Making Cider Vinegar at Home*. F. H. Hall and L. L. Van Slyke. Bul. 258. N. Y. Agr. Expt. Station, Geneva, N. Y. 1904.
6. *Pickles and Relishes*. Carrie Pancoast. Extension Circular 35. University Missouri. 1917.
7. *Pickles, Chowchow, Chile Sauce, Sauerkraut, etc.* Emergency Food Series 21. Connecticut Agr. College Extension Service. 1917.
8. *Cucumbers*. L. C. Corbett. Farmers' Bul. 254. U. S. D. A. 1917.

9. *Preservation of Vegetables by Fermentation and Salting.* L. A. Round and H. L. Lang. U. S. D. A. Farmers' Bul. 881. 1917.
10. *Preservation of Vegetables by Salting.* W. V. Cruess. Illustrated Food Preservation Leaflet. University California Expt. Station. 1917.
11. *Preserving Vegetables by Fermentation.* Form A-90. States Relation Service Office of Extension Work South. U. S. D. A. 1917.
12. *Making Sauerkraut.* A. T. Erwin. Iowa State College Agr. Emergency Leaflet 24. 1917.
13. *Pickles.* Gladys L. Meloche. Rhode Island State College. 1917.
14. *Pickles.* Extension Division New Jersey Agr. College. 1917.
15. *Manual for Home Storage, Pickling, Fermentation and Salting of Vegetables.* National Emergency Food Garden Commission. Bul. 1917. 210-220 Maryland Bldg., Washington, D. C.
16. *Home Pickling of Ripe Olives.* F. T. Bioletti. University California Expt. Station. 1917.

### Meat Preservation

1. *Meat on the Farm. Butchering, Curing, and Keeping.* Andrew Boss. Farmers' Bul. 183. U. S. D. A. 1906.
2. *Preservation of Meat.* Extension Bul. 12, North Dakota Expt. Station. 1917.
3. *A Meat Curing Contest for North Carolina Pig Club Members and Curing Meat at Home.* Extension Circular 58. North Carolina Expt. Station. 1917.
4. *Method of Preparing and Curing Dried Beef.* Mrs. Levi Dodge. Leaflet, North Dakota Expt. Station, Feb., 1917.
5. *Killing Hogs and Curing Pork.* F. G. Ashbrook and G. A. Anthony. Farmers' Bul. 913. U. S. D. A.

**Cheese Making**

1. Extension Bul. 47. University Nebraska Expt. Station. *Farm Cheese Making*. J. H. Fraudsen and T. Thorson. 1917.
2. *Studies on the Factors Concerned in the Ripening of Cheddar Cheese*. E. G. Hastings, Alice Evans, and E. B. Hart. Research Bul. 25, University Wisconsin. 1912.
3. *Farm Cheese Making*. Extension Circular 30, University Missouri Expt. Station. L. G. Runkle.
4. *The Manufacture of Cottage Cheese in Creameries and Milk Plants*. A. O. Dahlberg. U. S. D. A. Dept. Bul. 576. 1917.
5. *Farm Dairy Cheese*. R. M. Washburn. Special Bul. 12. Agr. Extension Service, University of Minnesota. 1917.

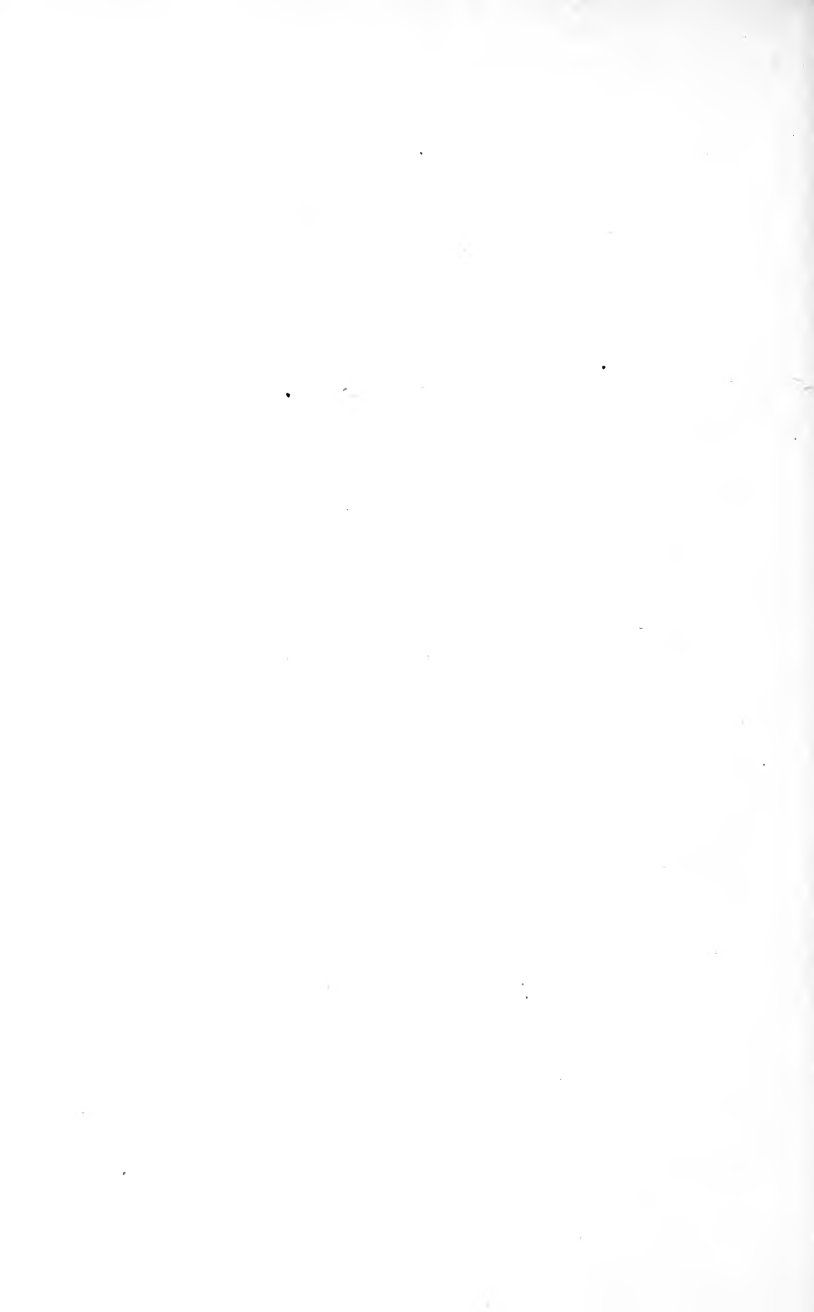

## INDEX

- Acid, addition to brine in vegetable canning, 49.  
necessity of, in jelly making, 80.  
test for jelly making, 80.
- Acid, acetic, formation in vinegar, 116.  
fermentation, control of, in vinegar making, 120-124.  
test for vinegar, 124.
- Acid, lactic, formation of, in vegetable preservation, 132.  
fermentation as a means of preservation, 132.
- Air, relation to spoiling, 12.  
effect of in pickling olives, 138.  
exclusion of, in pickling, 132, 228-231.  
necessity of, in vinegar fermentation, 121.
- Alcohol, antiseptic value of, 17.  
fermentation in fruit wines, 127, 225.  
fermentation in vinegar making, 118, 222.
- Antiseptics, in permanent preservation, 14.  
in temporary preservation, 10.
- Apple, butter, general principles, 87.  
butter, recipe, 202.  
canning, 165.  
cider, hard, 129, 226.  
cores, and skins, using, 223.  
drying recipes, 211, 216.  
jelly recipe, 198.  
jelly stock, 85 200.  
juice, recipe, 185.  
peeling machine, 26.
- Apple sirup, recipe, 192.  
vinegar, 116-124, 222-225.
- Apricot canning recipe, 162.  
candyng, 90, 208.
- Apricot drying, general, 93-112.  
drying recipes, 211, 216.  
jam, 202.
- Artichokes, canning recipe, 171.  
preservation in brine, 228.
- Asepsis as a means of food preservation, 9.
- Asparagus, canning recipe, 172.  
preservation in brine, 228.
- Aspergillus mold, 4.
- Bacillus botulinus, poisoning by, 58.
- Bacon, brine treatment, 245.  
dry salting, 245.  
smoking recipe, 248.  
smoke house, illustration, 146.
- Bacteria, lactic fermentation, 132.  
in canned foods, 58.  
in meats, 59.  
in vegetable preservation, 132.  
in vinegar making, 116, 120.  
in milk products, 150-154.  
types of, 6.
- Bag filter, illustration, 64.
- Balling tester for jelly and sirups, 82.
- Barrel for curing meats, 243.  
for vinegar making, illustration, 121.
- Barrel for preserving vegetables, illustration, 133.
- Beans, botulinus poisoning from, 58.  
canning recipe, 173.  
dried, canning recipe, 179.  
drying recipe, 218.  
fermentation, 132, 229.
- Beef, brine for preserving, 144, 244.  
corned, recipe, 244.  
dried, recipe, 248.

- Beets, canning recipe, 173.  
drying recipe, 219-220.  
fermentation of, 132, 229.  
peeling, 173.
- Berries, canning recipes, 167-168.  
drying recipes, 216.  
preserving, 89, 205.
- Blackberry, canning, 168.  
drying, 216.  
jam, 87, 202.  
jelly-making, 198-200.  
juice recipe, 188.
- Blanching, purpose of, 46.  
vegetables, 46.  
vegetables, illustration, 30.
- Boiled cider, 72-76, 192-194.
- Bottles, capping, 67.  
corking, 67.  
filling, 66.  
pasteurizing or sterilizing, 68.
- Bottling fruit juices, 66, 185-191.
- Bottling, jelly stocks, 200.  
vinegar, 125, 223.  
wine, 130, 226.
- Brine, acidified for vegetables, 48.  
for beef, 244.  
for butter, 255.  
for cucumbers, 134, 230.  
for fish, recipe, 246.  
for pork, recipe, 243.  
for olives, 240, 241.  
for vegetables, 133, 226.  
for canning vegetables, 48.
- Butter, fruit, general discussion, 87-89.  
fruit, recipes, 203.  
preservation in brine or salt, 255.
- Cabbage, drying recipe, 219, 220.  
fermentation for sauerkraut, 228.
- Candied fruits, general discussion, 90.  
recipes, 208.
- Canned foods, importance of, v.  
spoilage of, 57-59.
- Canners, factory made, 51.  
steam pressure, 51.
- Canning, equipment, 21-54.  
fruits, general discussion, 21-44.
- Canning fruits, recipes, 157-171.  
meats, general discussion, 55-57.  
meats, recipes, 182-184.  
outfits, factory-made, 51.  
vegetables, general discussion, 45-54.  
vegetables, recipes, 171-182.
- Cans, sanitary, 32.  
sealing, 29.  
solder top, 28, 158-161.  
spoiled, appearance of, illustration, 58.  
types of, illustration, 27.
- Capping bottles, 66.  
machine for bottles, illustration, 67.
- Caps for glass jars, 25.  
for bottles, 67.
- Carrots, canning recipe, 174.  
drying recipe, 219, 220.
- Cauliflower, pickling, 231.  
preservation in brine, 228.
- Celery, drying, 220.
- Chalk, precipitated, for fruit sirups, 73, 193.
- Cheese, Cheddar, general discussion, 153.  
Cottage, recipe, 254.  
Gouda, recipe, 251.
- Chemical preservatives, 10, 14.
- Cherries, canning, 164.  
candyng, 208-210.  
drying, 215, 216.  
pitting, 24.  
pitter (illustration), 25.
- Chili peppers, canning, 176.  
drying, 220.
- Chili sauce, recipe, 235.
- Chow chow, recipe, 233.
- Chutney, recipe, 237.
- Cider, hard, recipe, 226.  
sweet, recipe, 185.
- Citron, candyng, 90-92, 208-210.
- Clarification of fruit juices, recipe, 64, 190.  
of vinegar, recipe, 223.
- Clarifying materials, 64, 190, 223.
- Cleanliness as aid to preservation, 9.
- Cold storage, 9.



- Concentration of sirups, 73-75, 192-198.
- Conserves, general discussion, 89. recipes, 205-207.
- Containers for canned products, 25-29.  
for juices, 66.  
for vinegar, 223.  
for wine, 128.
- Cooker, pressure, illustration, 48. pressure, description, 50-52.
- Cooling cans after sterilizing, 52.
- Corking bottles of juice, 66, 185.
- Corn, canning recipe, 174. drying recipe, 219, 220.
- Crabapple jelly, recipe, 198.
- Cranberry jelly, 198.
- Crusher for fruits, for home use, illustration, 61.  
for farm use, illustration, 63.
- Cucumber, dill pickle recipe, 230. relishes, recipes, 234-239. sweet pickles, recipe, 232. vinegar pickles, recipe, 231.
- Currant jelly recipe, 198. jelly stock, 200.
- Dill pickles, recipe, 230.
- Dixie relish, recipe, 236.
- Driers for home use, 105.  
for farm use, 104-109. illustrations, 105, 106, 107.
- Drying fruit, general discussion, 93-112. recipes, 211-217.
- Drying meats, recipes, 248, 250.
- Drying vegetables, general discussion, 112-116. recipes, 217-221.
- Eggs, preservation in brine and salt, 250.  
preservation in waterglass, 149, 250.
- Evaporating, 104-109.
- Evaporators, 104-109.
- Exclusion of air as means of preservation, 12, 17.
- Exhausting, theory and discussion, 40.
- Fermentation, alcoholic, in fruit wines, 127, 225.  
alcoholic, in vinegar making, 118-120, 222.  
lactic, in vegetable preservation, 132, 228-231.  
lactic, in milk, 153.  
vinegar, 120, 223.
- Figs, candying recipe, 208-210.  
canning recipe, 166.  
drying, general, 93-112.  
drying recipe, 215.  
jam, 202.  
preserves, recipe, 205.  
sweet pickle, 232.
- Filtration, of fruit juices, 66, 185.  
of jelly material, 79.  
of vinegar, 125, 223.
- Fire pot, for heating soldering steels, illustration, 33.
- Fish, canning, general, 55-57.  
canning recipe, 183.  
drying recipe, 249.  
salting recipe, 246.  
smoking recipe, 248.
- Flux, soldering, directions for making, 259.
- Food, canning, 21-60, 157-185.  
causes of spoiling, 3-9.  
drying, 93-116, 211-222.  
permanent preservation, theory of, 12-19.  
temporary preservation, theory of, 9-12.
- Food poisoning, 57.
- Fruits, butters, and jams, 87, 202.  
candying, 90, 208.  
canning, 21-44, 157-171.  
drying, general, 93-116.  
drying, recipes, 211-218.  
jellies and jelly stocks, 76-86, 198-202.  
juices, 60-72, 185-192.  
picking for canning, drying, etc., 21.  
preserving, 89, 205.  
sirups, 72-76, 192.

- Germs, in relation to spoiling, 3-9, 57.
- Glass jars, 25.
- Gooseberries, canning recipe, 170.
- Grading fruits and vegetables, 23.
- Greens, canning recipe, 177.
- Grape, jelly, 198.  
 juice, general discussion, 60-71.  
 juice, recipes, 186.  
 sirup, 71, 192.
- Grapes, canning, 169.  
 drying recipes, 214.
- Grape fruit, jelly, 198.  
 juice, 60-71, 189.  
 marmalade, 201.
- Guava jelly, 198.
- Ham, recipes for salting, 243, 245.  
 recipe for smoking, 248.
- Home canning outfits factory-made, 51.  
 home-made, 41.
- Home dryers, 104-108.
- Hominy, recipe for making and canning, 179.
- Hydraulic presses, 63.
- Intermittent sterilization, 52.
- Jams, general discussion, 87.  
 recipes, 202.
- Jars, closing, illustration, 46.  
 filling with hot fruit, illustration, 31.  
 filling with sirup or brine, illustration, 32.  
 types of, illustration, 25.  
 washboiler sterilizer, illustration, 32.
- Jar rubbers, 26.
- Jellies, acid test, 80.  
 clearing juice for, 79.  
 cooking the fruit, 77.  
 crystallization of, 85.  
 fruits for jelly, 76.  
 hydrometer test, 82.  
 pectin test, 79.  
 pectin test, illustration, 76.  
 recipes, 198-202  
 sealing with paraffin, 83.
- Jellies, sheeting test, 81.  
 sterilizing, 84.  
 thermometer test, 81.
- Jelly stocks, general, 85.  
 recipes, 200.
- Juices, fruit, bottling, 66.  
 clarifying, 64, 190.  
 filtering, 64.  
 fruits, suitable for, 60.  
 general discussion, 60-72.  
 pasteurizing, 68.  
 pasteurizing, illustration, 68.  
 recipes, 185-191.  
 sealing bottles, illustration, 70.
- Ketchup, cooking, 141, 233.  
 general discussion, 141.  
 recipe, 238.  
 spices, addition of, 238.  
 sterilizing, 239.
- Labelling, canned foods, 34, 259.
- Legal standard for vinegar, 259.
- Lemon, candied peel, 101, 208.  
 jelly, 77, 198.  
 juice, 188.  
 marmalade, with oranges or grape fruit, 201.
- Lemon juice method of canning vegetables, 48.
- Lima beans, canning, 179.
- Lime and lime carbonate, use in sirups, 72, 193.
- Lye, for hominy, 179.  
 for pickling olives, 240, 241.  
 for peeling peaches and apricots, 163.
- Machine, apple peeling, illustration, 26, 212.  
 bottle capping, illustration, 67.  
 can sealing, illustration, 35, 38.  
 slicing, for vegetables, 220.  
 vegetable peeling, 104.
- Marmalade, fruit recipe, 201.  
 orange, recipe, 201.  
 from other fruits, 201.  
 slicer, illustration, 86.
- Marmalades, general discussion, 85.

- Marmalades, recipes, 201.
- Meats, canning, general discussion, 55-57.  
canning, recipes, 143-150.  
drying, 248, 250.  
preservation of, general discussion, 143-150.  
preservation of, recipes, 243-250.
- Meats, salting, general, 143-145.  
salting, recipes, 243-247.  
smoking, general, 145-148.  
smoking, recipes, 247-250.
- Mixed pickles, recipe, 234.
- Moisture, exclusion of, 10.
- Molds, in relation to spoiling, 3-5.  
destruction of, by heat, 4.  
growth on jelly and fruit, 4.
- Mother of vinegar, use in vinegar making, 120.
- Mustard pickles, recipe for, 234.
- Okra, canning recipe for, 180.
- Olives, brine for canning, recipe for, 241.  
brine for green, recipe for, 241.  
canning, 139, 241.  
coloring, by exposure to air, 137.  
green, pickling recipe for, 241.  
first lye treatment of, 137.  
second lye treatment of, 138.  
ripe, pickling recipe for, 240.  
sterilizing, 139, 241.  
vats, in large factory, illustration, 137, 138.  
washing out excess lye of, 138.
- Onions, drying, recipe for, 219.  
pickling, recipe for, 231.
- Orange, candying peel of, 208.  
canning recipe for, 168.  
jelly recipe for, 198.  
juice recipe for, 189.
- Orange-Lemon, marmalade, 201.  
juice, 189.
- Organisms and spoiling, 3-9.
- Paraffin, use of, in sealing jelly, 83, 200.  
use of, in sealing salted vegetables, 132, 228-230.
- Parsnips, canning, 174.  
drying, 220.
- Paste, fruit, 88, 203.  
tomato, recipe for, 239.
- Pasteurization, general, 11.  
of fruit juices, 68.  
of milk, 150.
- Pasteurizer for fruit juices, 68.
- Peach butter, recipe for, 202.  
paste, 203.  
preserves, 205.
- Peaches, candying, recipes for, 208.  
canning, general, 21-44.  
canning recipes for, 157.  
drying recipes for, 211, 216.  
lye peeling, 163.  
pickling recipe for, 232.  
pitting clingstone, 23.
- Peas, canning recipe for, 175.  
drying, 218.  
sterilizing canned, 50, 175.  
sterilizing sun dried, 115.
- Pears, candying, 90, 208.  
canning, recipe for, 163.  
drying, 211.
- Pears, sweet pickling, recipe for, 232.  
for vinegar, 116.
- Pectin content in various fruits, table, 77.  
importance of, in jelly, 77.  
testing, in jelly making, 79.
- Peeling, fruits, 23.  
lye, method, 163.  
peppers and pimentos, recipe for, 176.  
vegetables, 45.
- Penicillium mold (blue mold), 3.
- Peppers, canning, 176.  
drying, recipe for, 220.  
peeling, 176.
- Picking fruits for canning, 21.  
fruits for drying, 94.  
vegetables for canning, 45.
- Pickling, fruits and vegetables, general, 131-143.  
fruits and vegetables, recipes for, 231-243.
- Pimento canning, 176.  
peeling, for canning, 176.

- Pineapple, candying recipe, 208.  
canning, 170.  
juice, 190.
- Plums, canning, 165.
- Pork, brines for preserving, recipes for, 243, 245.  
dry salting, recipe for, 245.  
salting and smoking, general, 143-149.  
smoking, recipe for, 248.  
storing cured, 148.
- Poultry, canning, recipes for, 182.
- Preservation of foods, theory of, 9-18.  
general discussion of, 18-157.  
recipes for, 157-257.
- Preservatives, 10, 14.
- Preserves, general, 89.  
recipes for, 205-208.
- Press, fruit, illustrations, 62, 63.
- Pressing fruits, 63.  
sorghum, 194.
- Processing, canned foods, 41, 50.
- Prunes, dipping, for drying, illustration, 96, 97.  
drying, recipe for, 213.  
lye solution for dipping, 214.  
picking, for drying, illustration, 94.
- Pumpkin, canning, 176.  
drying, 219.
- Quince jelly, 76, 198.  
preserves, recipe for, 205.
- Raspberries, canning, recipe for, 168.  
drying, recipe for, 216.  
preserving, 89, 205.
- Relishes, recipes for, 233-239.
- Retorts, description of, 50.
- Retort, illustration, 48.
- Rhubarb, canning, without sterilization, 166.  
sterilizing, recipe for, 166.
- Rubbers, jar, 26.
- Saccharometers, description of, 37.  
use of, in jelly making, 82.  
use of, in sirup making, 74.
- Salmon, canning recipe for, 183.  
drying recipe for, 249.  
salting recipe for, 246.  
smoking recipe for, 248.
- Salt, as a preservative, general, 11.  
brines for vegetables, 132-134.  
brines for meats, recipes for, 243-246.  
brines for olives, recipes for, 240-242.
- Salting, meats, 245.  
vegetables, general, 131-135.  
vegetables, recipes for, 227-231.
- Saltpetre, use of, in meat preservation, 144.
- Sanitary cans, 32.
- Sauerkraut, general discussion of, 132.  
recipe for, 228.
- Scale for home canning, illustration of, 28.
- Sealing, bottles, 70.  
cans, 28, 158-161.  
jars, 43.
- Sirup for candying fruits, recipe for, 208.  
apparatus for sun evaporation, 73.  
for fruit canning, 37.  
hydrometers, 37.
- Sirups, general discussion of, 72-76.  
recipes for, 192-198.
- Slicing apples, 95.  
machine for vegetables, illustration of, 220.
- Smokehouse, description of, 146.  
illustration of, 146.
- Smoking beef, recipe for, 248.  
fish, 248.
- Smoking, general discussion of, 145-148.  
materials suitable for producing smoke, 147.  
pork, recipe for, 248.  
recipes for, 247-250.
- Spices, for dill pickles, 230.  
for sweet pickles, 232.
- Spinach, canning, recipe for, 177.  
salting, 227.

- Spoiling of food, general, 3-8.  
of canned foods, 57-60.
- Spoiled food, poisoning from botulinus in, 58.
- Spores, bacterial, resistance to heat of, 6.  
mold, 3-5.
- Squash, canning recipe for, 176.  
drying recipe for, 219.
- Starters, vinegar bacteria for vinegar, 120.  
yeast, for vinegar, 118.  
yeast, for wines, 127.
- Steam pressure sterilizers, 48, 50.
- Steels, soldering, use of, 158-161.
- Sterilization, general, 13.  
of canned fruits, 41.  
of canned meats, 56.  
of canned vegetables, 50.  
of fruit juices, 68.  
of jellies, 84.
- Sterilizers, factory-made, 50.  
home-made, 41.
- Storage of canned foods, 57.
- Storage of cured meats, 148.  
of dried fruit, 110.  
of dried vegetables, 115.
- Straining fruit juices, 64.
- Strawberries, canning, recipe for, 167.  
preserving, recipe for, 205.
- String beans, canning, 173.  
drying, 218.  
fermentation of, recipe for, 228.  
salting, recipe for, 227.
- Sugar in candying fruits, 90, 208.  
cane, vs. beet, 39.  
hydrometers, 37.  
in canning, 37-40.  
in jelly making, 82.  
in preserves, 89, 207.  
sirups for canning, 37.
- Sulphuring fruits for drying, 96.  
vegetables for drying, 113.
- Sun drying fruits, 93-104.  
vegetables, 112-114.
- Sweet pickles, recipes for, 232.
- Sweet potatoes, canning, recipe for, 178.  
drying, recipes for, 219, 220.
- Table for making canning sirups, 39.  
showing relation of steam pressure and temperature, 51.
- Temperature necessary for sterilizing fruits, 41.  
necessary for fruit juices, 68.  
necessary for meats, 56.  
necessary for vegetables, 50.  
of jelly at boiling point, 82.  
used in drying fruits, 105, 216.  
used in drying vegetables, 220.
- Test, acid, in jelly making, 80.  
pectin, in jelly making, 79.
- Thermometer, use of, in jelly making, 82.  
use of, in making preserves, 89.
- Tin cans, sanitary, 32.  
solder top, 28.  
wax top, 26.
- Tipping solder top cans, 160, 161.
- Tomatoes, canning, recipe for, 177.  
drying, recipe for, 220.  
ketchup, recipe for, 238.  
paste, 239.  
peeling, 177.  
pickling, recipe for, 231, 238.
- Turnips, canning, recipe for, 174.  
drying, recipe for, 219.
- Utensils, useful, in canning, 28.
- Vacuum in canned foods, 40.
- Vegetables in brine, general, 132-134.  
in brine, recipes for, 228-231.
- Vegetables, canning, general, 45-54.  
canning, recipes for, 171-182.  
drying, general, 112-114.  
drying, recipes for, 218-222.  
fermentation of, 132, 228-231.  
grading of, for canning, 45.  
packing dried, illustration of, 114.  
peeling, 45, 112.  
salting, 131-134, 227-231.  
spoilage of canned, 57.  
sterilizing canned, 50.  
sterilizing dried, 115.

- Vinegar, alcoholic fermentation  
of, 118-120.  
bacteria in vinegar making, 120-124.  
clarifying, 125.  
diseases, 125.  
eels, 126.  
fermentation, control of, 121.  
filtering, 125.  
generators, 122.  
generators, illustrations of, 122.  
legal standards for, 259.  
Leo acid tester for, illustration of, 124.  
"mother," 120.  
for pickling, 135, 231-235.  
spiced, 232.  
spoilage, 125.  
vats used in large factories, 117.
- Washboiler sterilizer for canning, 41.  
Washboiler sterilizer for sterilizing fruit juices, 68.  
illustration of, 41.  
Watermelon, candying of, rind, recipe for, 208.  
preserves, 206.  
Wax top cans, 26.  
"Wine flowers," 125.  
Wines, fruit, general, 126-131.  
fruit, recipes for, 225.
- Yeast as cause of spoiling, 5.  
in making fruit wines, 127.  
use of in vinegar, 118.
- Zinc chloride soldering fluid, 259.

**T**HE following pages contain advertisements of  
books by the same author or on kindred subjects

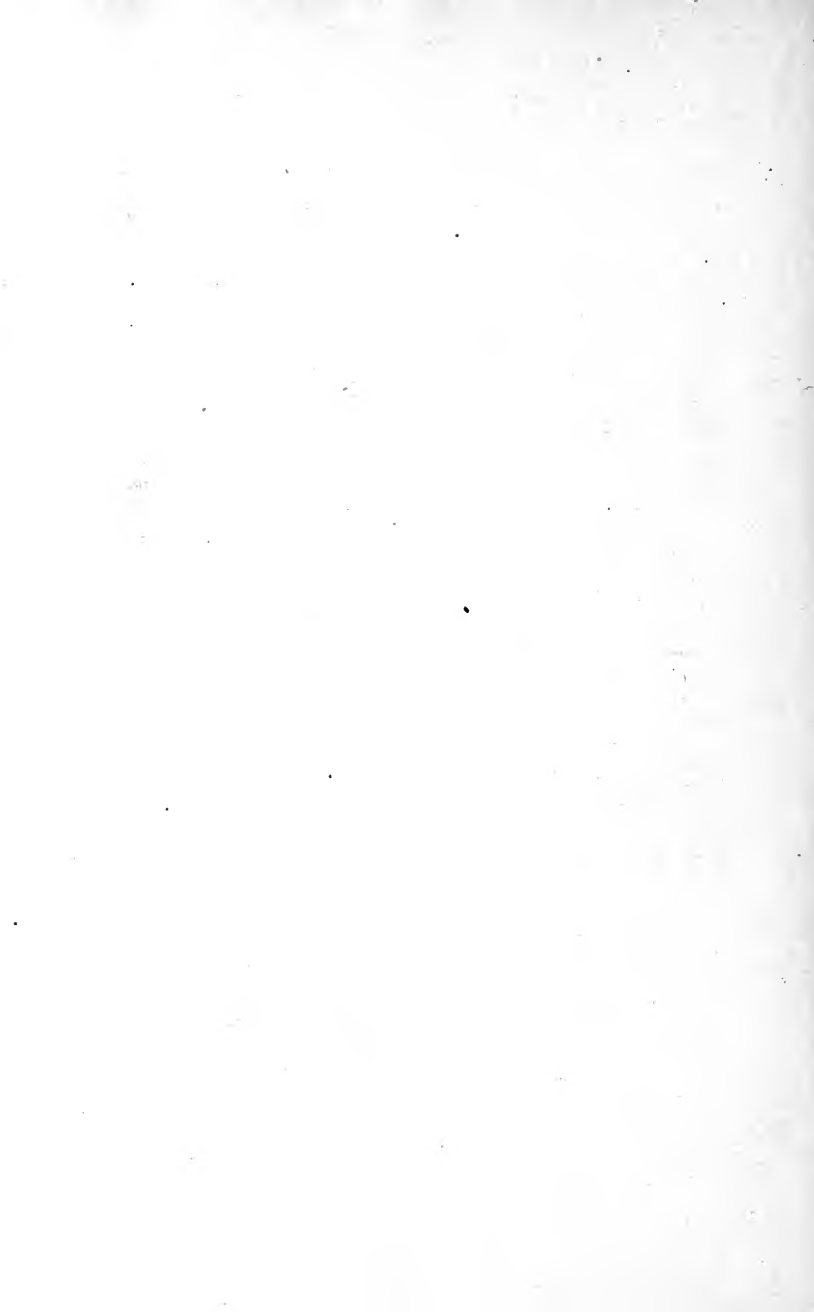



# The Food Problem

BY VERNON KELLOGG AND ALONZO E. TAYLOR

\$1.25

"Food is always more or less of a problem in every phase of its production, handling, and consumption. It is a problem with every farmer, every transporter and seller, every householder. It is a problem with every town, state, and nation. And now very conspicuously, it is a problem with three great groups; namely, the Allies, the Central Empires and the Neutrals; in a word, it is a great international problem."

These sentences from the introduction indicate the scope of "The Food Problem" by Vernon Kellogg and Alonzo E. Taylor.

Both authors are members of the United States Food Administration. Dr. Kellogg is also connected with the Commission for relief in Belgium and professor in Stanford University. Mr. Taylor is a member of the Exports Administrative Board and professor in the University of Pennsylvania. The preface is by Herbert Hoover, United States Food Administrator and Chairman for the Commission of Relief in Belgium.

The food problem of to-day of our nation, therefore, has as its most conspicuous phase an international character. Some of the questions which the book considers are:

What is the problem in detail?

What are the general conditions of its solution?

What are the immediate problems and particulars which concern us, and are within our power to affect?

And finally, what are we actually doing to meet our problem?

## TABLE OF CONTENTS

Introduction: The International Problem.

*Part I. The Problem and the Solution.*

Chapter I. The Food Situation of the Western Allies and the United States.

II. Food Administration.

III. How England, France, and Italy Are Controlling and Saving Food.

IV. Food Control in Germany and Its Lessons.

*Part II. The Technology of Food Use.*

V. The Physiology of Nutrition.

VI. The Sociology of Nutrition.

VII. The Sociology of Nutrition (*Continued*).

VIII. Grain and Alcohol.

Conclusion: Patriotism and Food.

---

THE MACMILLAN COMPANY

Publishers

64-66 Fifth Avenue

New York

# Some Aspects of Food Economy

BY MARY S. ROSE

## **Everyday Foods in War Time**

\$ .80

This little book was written in response to a request for "a war message about food." It gives a simple explanation of the part which some of our common foods play in our diet, and points out how the necessary saving of fat, fuel, sugar, and meat can be made without a loss of health or strength.

There are chapters on the Milk Pitcher in the Home; Cereals We Ought to Eat; Meats We Ought to Save; The Potato and Its Substitutes; Are Fruits and Vegetables Luxuries? Sugar and Spice and Everything Nice; On Being Economical and Patriotic at the Same Time.

## **Feeding the Family**

\$2.10

This is a clear concise account in simple everyday terms of the ways in which modern knowledge of the science of nutrition may be applied in ordinary life. The food needs of the members of the typical family group—men, women, infants, children of various ages—are discussed in separate chapters, and many illustrations in the form of food plans and dietaries are included. The problems of the housewife in trying to reconcile the needs of different ages and tastes at the same table are also taken up, as are the cost of food and the construction of menus. A final chapter deals with feeding the sick.

---

THE MACMILLAN COMPANY

Publishers

64-66 Fifth Avenue

New York

# War Bread

\$ .60

By ALONZO E. TAYLOR

A clear statement of the vital importance of wheat conservation.

# Butter

By E. S. GUTHRIE

Professor in the Dairy Department, New York State College of Agriculture, Cornell University

A practical discussion of the general characteristics of butter, and of all of the problems connected with its manufacture and marketing, together with a brief history of the product. Among the topics considered are the history of butter; composition and food value of butter; cleansing and care of dairy utensils; care of milk and cream; cream separation; grading milk and cream and neutralizing acidity; pasteurization; cream ripening; churning, washing, salting and packing butter; flavors of butter; storage of butter; marketing; whey butter, renovated and ladled butter; margarine, and testing.

# Cheese

By CHARLES THOM

Mycologist in charge of Microbiological Laboratory, Bureau of Chemistry, United States Department of Agriculture; formerly Investigator in Cheese at Connecticut Agricultural College

AND

WALTER W. FISK

Assistant Professor of Dairy Industry, New York State College of Agriculture at Cornell University

An exposition of the processes of making and handling a series of important varieties of cheese. The kinds considered are those made commercially in America or widely met in the trade here. The relation of cheese to milk and to its production and composition has been presented in so far as required for this purpose.

THE MACMILLAN COMPANY

Publishers 64-66 Fifth Avenue New York

# A Manual of Milk Products

BY W. A. STOCKING, JR.

Professor of Dairy Bacteriology in the New York State College of  
Agriculture at Cornell University

---

\$2.00

This is the most recent addition to the Rural Manual Series under the editorship of L. H. Bailey. The work is intended to serve as a reference book covering the entire subject of milk and its products. There are chapters on The Chemical Composition of Milk, The Factors Which Influence Its Composition, Physical Properties, The Various Tests Used in the Study of Milk, The Production and Handling of Milk, Butter Making, The Cream Supply, Butter Making on the Farm, Cheese Making, and the Bacteriology of Dairy Products.

---

**THE MACMILLAN COMPANY**

**Publishers**

**64-66 Fifth Avenue**

**New York**

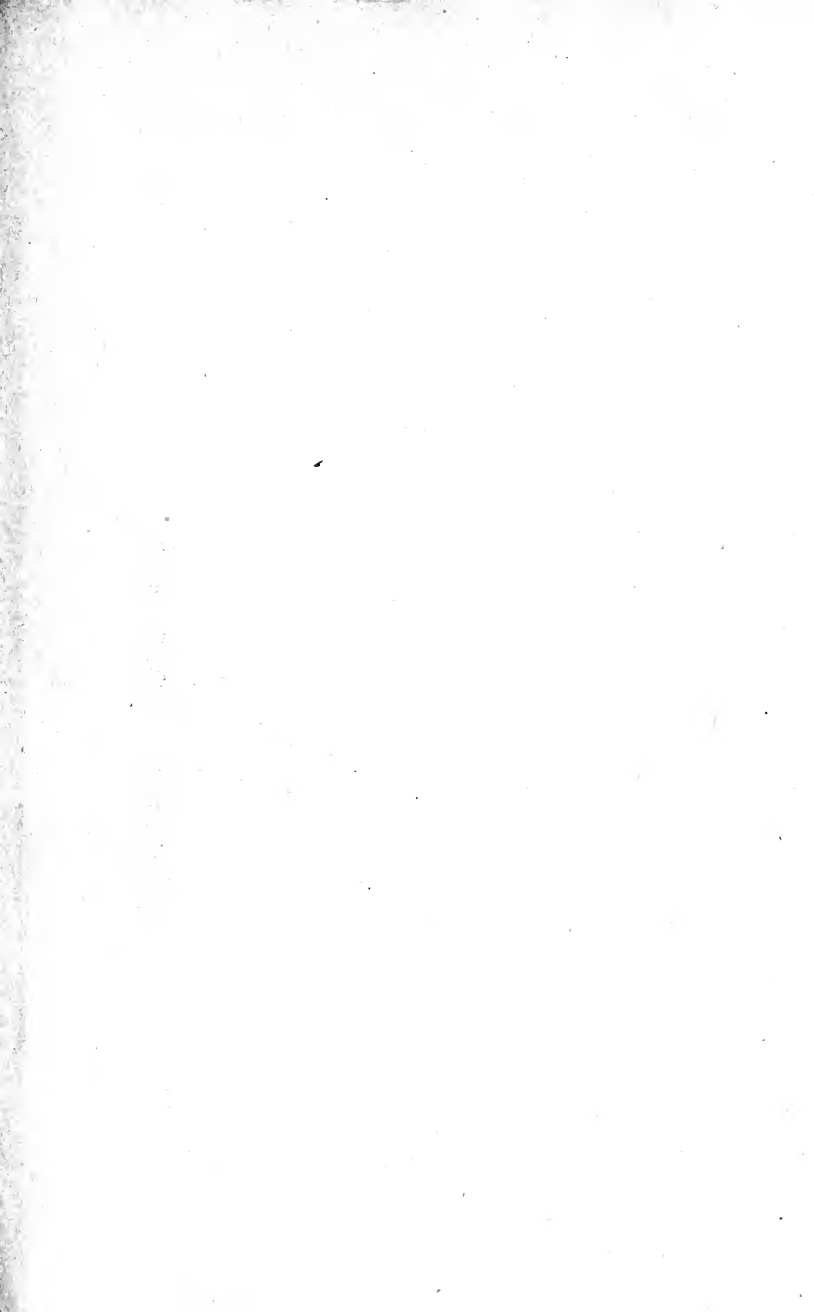



YB 67885



