

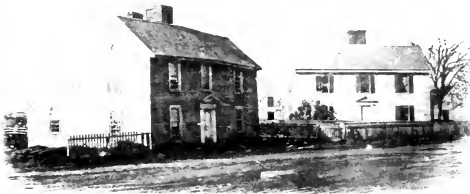

John Adams Library,



IN THE CUSTODY OF THE
BOSTON PUBLIC LIBRARY.



SHELF NO°

★ 290.4
★

2 1/2
1 1/2
1 1/2
2 1/2
6 1/2
Box
Case
A

857



Horfe-Hoeing Husbandry:

O R,

An ESSAY on the PRINCIPLES

O F

Vegetation *and* Tillage.

Designed to introduce

A NEW METHOD of CULTURE ;

WHEREBY

The Produce of Land will be increased, and the
usual Expence lessened.

Together with

Accurate DESCRIPTIONS and CUTS of the Instruments
employed in it.

By JETHRO TULL, *Esq;*
Of Shalborne in Berkshire.

The FOURTH EDITION, very carefully Corrected.

To which is prefixed,

A New PREFACE by the EDITORS, addressed to all
concerned in AGRICULTURE.



L O N D O N :

Printed for A. MILLAR, opposite to *Catharine-street*
in the *Strand*.

M. DCC. LXII.

2000 0000 2000.7

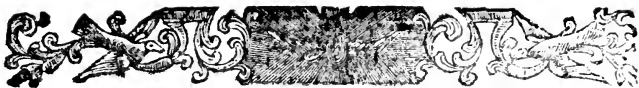

T H E
P R E F A C E.



S Mr. *Tull's* Essay on *Horse-boeing Husbandry* has been published some Years, it may be presumed that the World hath by this time formed some Judgment of his Performance; which renders it the less necessary for the Editors of this Impression to say much concerning it. For every Man who has attended to the Subject, and duly considered the Principles upon which our Author's Method of Culture is founded, is an equal Judge how far his Theory is agreeable to Nature: Though it is but too true, that few have made sufficient Experiments to be fully informed of its Worth.

How it has happened, that a Method of Culture, which proposes such Advantages to those who shall duly prosecute it, hath been so long neglected in this Country, may be matter of Surprize to such as are not acquainted with the Characters of the Men on whom the Practice thereof depends; but to those who know them thoroughly it can be none. For it is certain that very few of them can be prevailed on to alter their usual Methods upon any Consideration; though they are convinced that their

continuing therein disables them from paying their Rents, and maintaining their Families.

And, what is still more to be lamented, these People are so much attached to their old Customs, that they are not only averse to alter them themselves, but are moreover industrious to prevent others from succeeding, who attempt to introduce any thing new; and indeed have it too generally in their Power, to defeat any Scheme which is not agreeable to their own Notions; seeing it must be executed by the same Sort of Hands.

This naturally accounts for Mr. *Tull's* Husbandry having been so little practised. But as the Methods commonly used, together with the mean Price of Grain for some Years past, have brought the Farmers every-where so low, that they pay their Rents very ill, and in many Places have thrown up their Farms; the Cure of these Evils is certainly an Object worthy of the public Attention: For if the Proprietor must be reduced to cultivate his own Lands, which cannot be done but by the Hands of these indocile People, it is easy to guess on which Side his Balance of Profit and Loss will turn.

This Consideration, together with many others which might be enumerated, hath induced the Editors to recommend this Treatise once more to the serious Attention of every one who wishes well to his Country; in hopes that
some

ſome may be prevailed upon, by regard either to the public Good or their own private Intereſt, to give the Method here propoſed a fair and impartial Trial : For could it be introduced into ſeveral Parts of this Country by Men of generous Principles, their Example might, in time, eſtabliſh the Practice thereof, and bring it into general Uſe; which is not to be expected by any other means.

It is therefore to ſuch only, as are qualified to judge of a Theory from the Principles on which it is founded, that the Editors addreſs themſelves, deſiring they will give this Eſſay another Reading with due Attention : and at the ſame time they beg leave to remind them how unfit the common Practiſers of Huſbandry are to paſs Judgment, either on the Theory or Practice of this Method ; for which Reaſon it is hoped that none will be influenced by ſuch, but try the Experiment themſelves with proper Care.

As a Motive to this, it is to be obſerved that, although the Method of Culture here propoſed has made little Progreſs in *England*, it is not like to meet with the ſame Neglect abroad, eſpecially in *France*; where a Tranſlation of Mr. *Tull's* Book was undertaken, at one and the ſame time, by three different Perſons of Conſideration, without the Privity of each other : But afterwards, Two of them put their Papers into the Hands of the Third, Mr. *Du Hamel du Manceau*, of the *Royal Academy of Sciences* at *Paris*, and of

the *Royal Society* at *London*; who has published a Book, intituled, *A Treatise of Tillage on the Principles of Mr. Tull*. The ingenious Author has indeed altered the Method observed by Mr. *Tull* in his Book; yet has very exactly given his Principles and Rules: But as he had only seen the First Edition of the *Horse-hoeing Husbandry*, so he is very defective in his Descriptions of the Ploughs and Drills, which in that were very imperfect, and were afterwards amended by Mr. *Tull* in his Additions to that Essay.

One of our principal Reasons for taking Notice of this Book is, to shew the Comparison this Author has made between the Old Method of Husbandry and the New. By his Calculation the Profits arising from the New, are considerably more than double those of the Old. For, according to him, the Profits of Twenty Acres of Land for Ten Years, amount, at 10*d.* $\frac{1}{2}$ per Livre,

	<i>l.</i>	<i>s.</i>	<i>d.</i>	
By the Old Method, to 3000 Livres, or	131	5	0	}
By the New Method, to 7650 Livres, or	334	13	9	

which makes a prodigious Difference in favour of the latter. As this Computation was made by one who cannot be supposed to have any Prejudice in favour of Mr. *Tull*'s Scheme, it will naturally find more Credit with the Public than any Comparison made by Mr. *Tull* himself, or by such as may have an Attachment to his Principles.

It may probably be expected, that the Editors should take Notice of such Objections as have been made, either to Mr. *Tull's* Theory or Practice; but we do not know any that in the least affect his Principles: They stand uncontroverted: Nor are there any to the Practice, which may not be equally urged against every Sort of Improvement. One of the principal which have come to our Knowledge is, its being impracticable in common Fields, which make a great Part of this Country, without the Concurrence of every one who occupies Land in the same Field. But doth not this equally affect the Old Husbandry? For every such Person is obliged to keep the Turns of plowing, fallowing, &c. with the other Occupiers; so that if any of them were inclinable to improve their Lands, by sowing Grass-seeds, or any other Method of Culture, they are now under the same Difficulties as they would be, were they to practise Mr. *Tull's* Method. Therefore this is rather to be lamented as a public Misfortune, than to be brought as an Objection to the Practicableness of that Method. Others object, that the introducing this Sort of Husbandry is unnecessary, seeing the Improvements which are made by Grass-seeds are so considerable; besides, that the Returns made by the Fold and the Dairy, being much quicker than those of Grain, engage the Farmer to mix Plowing and Grazing together. But when this is duly considered it

can have no sort of Weight : for is it not well known that, in those Farms where the greatest Improvements have been made by Grass-feeds, the Quantity of Dressing required for the Arable Land often runs away with most of the Profit of the whole Farm? especially when the Price of Grain is low. And if this be the Situation of the most improved Farms, what must be the Case of those which chiefly consist of Arable Land; where most of the Dressing must be purchased at a great Price, and often fetched from a considerable Distance? Add to this the great Expence of Servants and Horses, unavoidable in Arable Farms; and it will appear how great the Advantages are which the Grazier hath over the plowing Farmer. So that it is much to be wished, the Practice of mixing the Two Sorts of Husbandry were more generally used in every Part of the Kingdom; which would be far from rendering Mr. *Tull*'s Method of Culture useless; seeing that, when it is well understood, it will be found the surest Method to improve both.

For although Mr. *Tull* chiefly confined the Practice of his Method to the Production of Grain (which is a great Pity), yet it may be extended to every Vegetable which is the Object of Culture in the Fields, Gardens, Woods, &c. and perhaps may be applied to many other Crops, to equal, if not greater Advantage, than to Corn.

In the Vineyard it has been long practised with Success ; and may be used in the Hop-Ground with no less Advantage. For the Culture of Beans, Peas, Woad, Madder, and other large-growing Vegetables ; as also for Lucern, Saintfoin, and the larger Grasses ; we dare venture to pronounce it the only Method of Culture for Profit to the Farmer ; seeing that, in all these Crops, one Sixth Part of the Seeds now commonly sown will be sufficient for the same Quantity of Land, and the Crop in Return will be much greater ; which, when the Expence of Seeds is duly considered, will be found no small Saving to the Farmer.

Nor should this Method of Culture be confined to *Europe* : for it may be practised to as great Advantage in the *British* Colonies in *America*, where, in the Culture of the Sugar-Cane, Indigo, Cotton, Rice, and almost all the Crops of that Country, it will certainly save a great Expence of Labour, and improve the Growth of every Plant, more than can be imagined by such as are ignorant of the Benefit arising from this Culture. And should the Subjects of *Great Britain* neglect to introduce this Method into her Colonies, it may be presumed our Neighbours will take care not to be *blameable on this Head* ; for they seem to be as intent upon extending every Branch of Trade, and making the greatest Improvements of their Land, as we are indifferent to both : So that, unless a contrary Spirit be soon exerted, the Balance of Trade,

Trade, Power, and every other Advantage, must be againſt us.

There have been Objections made by ſome to Mr. *Tull*'s Method, as if it were practicable only on ſuch Lands as are ſoft and light, and not at all on ſtiff and ſtony Ground. That it hath not been practiſed on either of theſe Lands in *England* we are willing to grant; but we muſt not from thence infer that it is impoſſible to apply it to them. For the Hoe-Plough has been very long uſed in the Vineyards in many Countries, where the Soil is ſtronger, and abounds with Stones full as much as any Part of this Country. However, though the Uſe of this Plough may be attended with ſome Difficulties upon ſuch Land, for Wheat, or Plants of low Growth, whoſe Roots may be in Danger of being turned out of the Ground, or their Tops buried by the Clods or Stones; yet none of the larger-growing Plants are ſubject to the ſame Inconveniencies. Beſides, the ſtronger the Soil is, the more Benefit will it receive from this Method of Culture, if the Land be thereby more pulverized; which will certainly be the Conſequence, where the Method laid down by Mr. *Tull* is duly obſerved.

But as moſt Inſtruments, in their Firſt Uſe, are attended with ſome Difficulty, eſpecially in the Hands of ſuch as are indocile, the Hoe-plough has been complained of, as cumbersome and unwieldy to the Horſe and Ploughman. But perhaps this ariſes chiefly from the Unwillingneſs of
the

the Workmen to introduce any new Instrument: Indeed, seeing little is to be expected from those who have been long attached to different Methods, the surest Way to promote the Use of it, is to engage young Persons, who may probably be better disposed, to make the Trial at their first entering into Business; and then a little Use will make it easy. It is proper to observe here, that the Swing-plough, which is commonly used in the deep Land about *London*, will do the Business of the Hoe-plough in all Ground that is not very strong, or very stony; and that where it is so, the Foot-plough, made proportionably strong, will completely answer all Purposes. But it must be remembered, that when these are used to hoe Corn, the Board on the Left Hand of the Plough, answering the Mould-Board, must be taken off; otherwise so much Earth will run to the Left Side, as to injure the Crop when it is low.

The *Drills* are excellent Instruments; yet we imagine them capable of some farther Improvement. Parallel Grooves, at about an Inch asunder, round the Inside of the Hopper, would shew the Man who follows the Drill, whether or no both Boxes vent the Seed equally. By an Hitch from the Plank to the Harrow, the latter may be lifted to a proper Height, so as not to be in the Way when the Ploughman turns at the Headland. Two light Handles on the Plank, like those of the common Plough, would

enable the Person who follows the Drill to keep it from falling off the Middle of the Ridge. It may also be useful, in wet Weather, to double the Drills; by which means Two Ridges may be sown at the same time, the Horse going between them: For the Planks of Two Drills, each Plank having one of the Shafts fixed to it, may be joined End for End by Two flat Bars of Iron, one on each Side, well secured by Iron Pins and Screws; and, by corresponding Holes in the Planks and Bars, the Distance between the Drills may be altered, according to the different Spaces between the Ridges.

The Alterations made by the Editors of this Impression are little more than omitting the controversial Parts of the Book, which were judged of no Service to the Reader, as they no-ways affected the Merits of Mr. *Tull's* Principles.

But as he endeavoured to recommend his Theory by drawing a Comparison between the Old Method of Culture and the New, so we beg leave to annex a Computation of the Expence and Profit of each; for which we are obliged to a Gentleman, who for some Years practised both in a Country where the Soil was of the same Nature with that from whence Mr. *Tull* drew his Observations, *viz.* light and chalky. And we chuse to give this the rather, as it comes from one who has no Attachment to Mr. *Tull's* Method, farther than that he found it answer in his Trials. We appeal to
Experience,

Experience, whether every Article in this Calculation is not estimated in favour of the Common Husbandry; whether the Expence be not rated lower than most Farmers find it, and the Crop such as they would rejoice to see, but seldom do, in the Country where this Computation was made.

In the New Husbandry every Article is put at its full Value, and the Crop of each Year is Four Bushels short of the other; tho', in several Years Experience, it has equalled, and generally exceeded, those of the Neighbourhood in the Old Way.

An Estimate of the Expence and Profit of Ten Acres of Land in Twenty Years.

I. In the Old Way.

First Year, for Wheat, costs							
33 <i>l.</i> 5 <i>s.</i> viz.	<i>l.</i>	<i>s.</i>	<i>d.</i>	<i>l.</i>	<i>s.</i>	<i>d.</i>	
First Plowing, at 6 <i>s.</i> per	}	3	0	0			
Acres - - - -							
Second and Third Ditto,	}	4	0	0			
at 8 <i>s.</i> per Acres - -							
Manure, 30 <i>s.</i> per Acres		15	0	0			
		<hr/>			22	0	0
Two Harrowings, and	}	1	5	0			
Sowing, at 2 <i>s.</i> 6 <i>d.</i>							
per Acres - - -							
Seed, three Bushels per	}	6	0	0			
Acres, at 4 <i>s.</i> per Bush.							
Weeding, at 2 <i>s.</i> per Acres		1	0	0			
Reaping, Binding, and	}	3	0	0			
Carrying, at 6 <i>s.</i> per							
Acres - - - -		<hr/>			11	5	0
		<hr/>			33	5	0

	l.	s.	d.
Brought over - - - - -	33	5	0
Second Year, for Barley, costs 11 l.			
<i>6 s. 8 d. viz.</i>			
Once Plowing, at 6 s. <i>per</i> } l. s. d.			
Acre - - - - - }	3	0	0
Harrowing and Sowing, } at 1 s. 6 d. <i>per</i> Acre, }	0	15	0
Weeding, at 1 s. <i>per</i> Acre	0	10	0
Seed, 4 Bushels <i>per</i> Acre, } at 2 s. <i>per</i> Bushel - }	4	0	0
Cutting, Raking, and } Carrying, at 3 s. 2 d. } <i>per</i> Acre - - - }	1	11	8
Grass-Seeds, at 3 s. <i>per</i> } Acre - - - - - }	1	10	0
	11 6 8		
	44 11 8		

Third and Fourth Years, lying in
Grass, cost nothing: So that the
Expence of Ten Acres in Four
Years comes to 44 l. 11 s. 8 d.
and in Twenty Years to - - }

222 18 4

First Year's Produce is } half a Load of Wheat } <i>per</i> Acre, at 7 l. - - }	35	0	0
Second Years Produce is } Two Quarters of Bar- } ley <i>per</i> Acre, at 1 l. }	20	0	0
Third and Fourth Years } Grass is valued at 1 l. } 10 s. <i>per</i> Acre - - }	15	0	0
So that the Produce of } Ten Acres in Four } Years is - - - - }	70	0	0

And in Twenty Years it will be	-	350	0	0
Deduct the Expence, and there re-	}	<hr/>		
mains clear Profit on Ten Acres		127	1	8
in 20 Years by the Old Way	-	<hr/>		

II. *In the New Way.*

First Year's extraordinary Expence	}			
is, for plowing and manuring				
the Land, the same as in Old	}	22	0	0
Way		<hr/>		
Plowing once more, at	}	2	0	0
4 s. per Acre		<hr/>		
Seed, 9 Gallons per Acre,	}	2	5	0
at 4 s. per Bushel		<hr/>		
Drilling, at 7 d. per Acre		0	5	10
Hand-hoeing and Weed-	}	1	5	0
ing, at 2 s. 6 d. per Acre		<hr/>		
Horse-hoeing Six times,	}	5	0	0
at 10 s. per Acre		<hr/>		
Reaping, Binding, and	}	3	0	0
Carrying, at 6 s. per		<hr/>		
Acre				
The standing annual	}	13	15	10
Charge on Ten Acres is		<hr/>		
Therefore the Expence on Ten	}	275	16	8
Acres in Twenty Years is		<hr/>		
Add the Extraordinaries of the	}	297	16	8
First Year, and the Sum is		<hr/>		
The yearly Produce is at least	}			
Two Quarters of Wheat per Acre,				
at 1 l. 8 s. per Quarter; which, on	}	560	00	
Ten Acres in Twenty Years, a-		<hr/>		
mounts to				
Therefore, all things paid, there	}	262	3	4
remains clear Profit on Ten Acres		<hr/>		
in Twenty Years by the New Way	-	<hr/>		

So that the Profit on Ten Acres of Land in Twenty Years, in the New Way, exceeds that in the Old by 135*l.* 1*s.* 8*d.* and consequently is considerably more than double thereof: an ample Encouragement to practise a Scheme, whereby so great Advantage will arise from so small a Quantity of Land, in the Compass of a Twenty-one Years Lease; One Year being allowed, both in the Old and New Way, for preparing the Ground.

It ought withal to be observed, that Mr. *Tull's* Husbandry requires no Manure at all, tho' we have here, to prevent Objections, allowed the Charge thereof for the first Year; and moreover, that tho' the Crop of Wheat from the *Drill-plough* is here put only at Two Quarters on an Acre, yet Mr. *Tull* himself, by actual Experiment and Measure, found the Produce of his drilled Wheat-crop amounted to almost Four Quarters on an Acre: And, as he has delivered this Fact upon his own Knowledge, so there is no Reason to doubt of his Veracity, which has never yet been called in question. But that we might not be supposed to have any Prejudice in favour of his Scheme, we have chosen to take the Calculations of others rather than his, having no other View in what we have said, than to promote the Cause of Truth, and the public Welfare.

The Wheat and Turnep Drill-Boxes, or the Drill Plough complete, mentioned in this Treatise, may be had at Mr. *Mulford's* in *Curstons-street, Chancery-lane, London.*



CHAP. I.

Of ROOTS *and* LEAVES.



SINCE the most immediate Use of *Agriculture*, in feeding Plants, relates to their *Roots*, they ought to be treated of in the first Place.

Roots are very different in different Plants: But 'tis not necessary here to take notice of all the nice Distinctions of them; therefore I shall only divide them in general into two Sorts, *viz. Horizontal-Roots*, and *Tap-Roots*, which may include them all.

All have Branchings and Fibres going all manner of ways, ready to fill the Earth that is open.

But such *Roots* as I call *Horizontal* (except of Trees) have seldom any of their Branchings deeper than the Surface or Staple of the Earth, that is commonly mov'd by the Plough or Spade.

The *Tap-Root* commonly runs down Single and Perpendicular (*a*), reaching sometimes many Fathoms below.

This (tho' it goes never so deep) has horizontal ones passing out all round the Sides; and extend to several Yards Distance from it, after they are by their

(*a*) In this manner descends the first Root of every Seed; but of Corn very little, if at all, deeper than the Earth is tilled.

These first Seed *Roots* of Corn die as soon as the other *Roots* come out near the Surface, above the Grain; and therefore this first is not called a *Tap Root*; but yet some of the next *Roots* that come out near the Surface of the Ground, always reach down to the Bottom of the pulveriz'd Staple; as may be seen, if you carefully examine it in the Spring time; but this first Root in Saint-foin becomes a *Tap Root*.

Minuteness, and earthly Tincture, become invisible to the naked Eye.

A Method how to find the Distance to which Roots extend Horizontally.

Pl. 6. Fig. 7. Is a Piece or Plot dug and made fine in whole hard Ground, the End *A* 2 Feet, the End *B* 12 Feet, the Length of the Piece 20 Yards; the Figures in the middle of it are 20 *Turneps*, sown early, and well ho'd.

The manner of this Hoing must be at first near the Plants, with a Spade, and each time afterwards, a Foot farther Distance, till all the Earth be once well dug; and if Weeds appear where it has been so dug, hoe them out shallow with the Hand-Hoe. But dig all the Piece next the out Lines deep every time, that it may be the finer for the *Roots* to enter, when they are permitted to come thither.

If these *Turneps* are all gradually bigger, as they stand nearer to the End *B*, 'tis a Proof they all extend to the Outside of the Piece; and the *Turnep* 20 will appear to draw Nourishment from six Feet Distance from its Centre.

But if the *Turneps* 16, 17, 18, 19, 20, acquire no greater Bulk than the *Turnep* 15, it will be clear, that their *Roots* extend no farther than those of the *Turnep* 15 does; which is but about 4 Feet.

By this Method the Distance of the Extent of *Roots* of any Plant may be discover'd.

What put me upon this Method was an Observation of two Lands (or Ridges) drill'd with *Turneps* in Rows, a Foot asunder, and very even in them; the Ground, at both Ends, and one Side, was hard and unplow'd; the *Turneps* not being ho'd, were very poor, small, and yellow, except the Three outside Rows, *B*, *C*, *D*, which stood next to the Land (or Ridge) *E*, which Land being plow'd and harrow'd, at the time the Land *A* ought to have been ho'd,

gave

gave a dark flourishing Colour to these three Rows; and the *Turneps* in the Row *D*, which stood farthest off from the new-plow'd Land *E*, received so much Benefit from it, as to grow twice as big as any of the more distant Rows. The Row *C*, being a Foot nearer to the new-plow'd Land, became twice as large as those in *D*; but the Row *B*, which was next to the Land *E*, grew much larger yet (*a*).

F Plate 6. is a Piece of hard whole Ground, of about two Perch in Length, and about two or three Feet broad, lying betwixt those two Lands, which had not been plow'd that Year; 'twas remarkable, that during the Length of this interjacent hard Ground, the Rows *B*, *C*, *D*, were as small and yellow as any in the Land.

The *Turneps* in the Row *D*, about three Feet distant from the Land *E*, receiving a double Increase, proves they had as much Nourishment from the Land *E*, as from the Land *A*, wherein they stood; which Nourishment was brought by less than half the Number of *Roots* of each of these *Turneps*.

In their own Land they must have extended a Yard all round, else they could not have reach'd the Land *E*, wherein 'tis probable these few *Roots* went

(*a*) A like Observation to this on the Land *E*, has been made in several *Turnep* Fields of divers Farmers, where Lands adjoining to the *Turneps* have been well tilled; all the *Turneps* of the contiguous Lands that were within three or four Feet, or more, of the newly pulveriz'd Earth, received as great, or greater Increase, in the Manner as my Rows *B C D* did; and what is yet a greater Proof of the Length of *Roots*, and of the Benefit of deep Hoing, all these *Turneps* have been well Hand-ho'd; which is a good Reason why the Benefit of the deep Pulveration should be perceivable at a greater Distance from it than mine, because my *Turneps*, not being hoed at all, had not Strength to send out their *Roots* through so many Feet of unpulveriz'd Earth, as these can through their Earth pulveriz'd by the Hoe, tho' but shallowly.

This Observation, as 'tis related to me (I being unable to go far enough to see it myself) sufficiently demonstrates the mighty Difference there is between Hand-hoing and Horse-hoing.

more than another Yard, to give each *Turnep* as much Increase as all the Roots had done in their own Land.

Except that it will hereafter appear, that the new Nourishment taken at the Extremities of the Roots in the Land *E*, might enable the Plants to send out more new Roots in their own Land, and receive something more from thence.

The Row *C* being twice as big as the Row *D*, must be suppos'd to extend twice as far; and the Row *B*, four times as far, in proportion as it was of a Bulk quadruple to the Row *D*.

A *Turnep* has a Tap-Root, from whence all these Horizontal Roots are deriv'd.

And 'tis observable; that betwixt these two Lands there was a Trench, or Furrow, of about the Depth of nine or ten Inches, where these Roots must descend first, and then ascend into the Land *E*: But it must be noted, that some small Quantity of Earth was, by the Harrowing, fall'n into this Furrow, else the Roots could not have pass'd thro' it.

Roots will follow the open Mould (*a*), by descending
ing

(*a*) A Chalk-Pit, contiguous to a Barn, the Area of which being about 40 Perch of Ground, was made clean and swept; so that there was not the Appearance of any Part of a Vegetable. more than in the Barn's Floor: Straw was thrown from thence into the Pit, for Cattle to lie on; the Dung made thereby was haled away about three Years after the Pit had been cleansed; when, at the Bottom of it, and upon the Top of the Chalk, the Pit was cover'd all over with Roots, which came from a Witch-Elm, not more than Five or Six Yards in Length, from Top to Bottom, and which was about Five Yards above, and Eleven Yards from the Area of the Pit; so that in three Years the Roots of this Tree extended themselves Eight times the Length of the Tree, beyond the Extremities of the old Roots, at Eleven Yards Distance from the Body: The annual-increased Length of the Roots was near Three times as much as the Height of the Tree.

I'm told an Objection hath been made from hence against the Growth of a Plant's being in proportion to the Length of its Roots; but when the Case is fully stated, the Objection may vanish. This
Witch-

ing perpendicularly, and mounting again in the same manner: As I have observ'd the Roots of a Hedge to do, that have pass'd a steep Ditch two Feet deep, and reach'd the Mould on the other side, and there fill it; and digging Five Feet distant from the Ditch, found the Roots large, tho' this Mould was very shallow, and no Roots below the good Mould.

So in an Orchard, where the Trees are planted too deep, below the Staple or good Mould, the Roots, at a little Distance from the Stem, are all as near the upper Superficies of the Ground, as of those Trees, which are planted higher than the Level of the Earth's Surface.

But the Damage of planting a Tree too low in moist Ground is, that in passing thro' this low Part, standing in Water, the Sap is chill'd, and its Circulation thereby retarded.

One Cause of Peoples not suspecting Roots to extend to the Twentieth Part of the Distance which in reality they do, was from observing these Horizontal-Roots, near the Plant, to be pretty taper; and if they did diminish on, in proportion to what they do

Witch-Elm is a very old decay'd Stamp, which is here called a *Staggar*, appearing by its Crookedness to have been formerly a *Plasber* in an old White-thorn Hedge wherein it stands: It had been lopped many Years before that accidental Increase of Roots happened; it was stunted, and sent out poor Shoots; but in the third Year of these Roots, its Boughs being most of them horizontally inclined, were observed to grow vigorously, and the Leaves were broad, and of a flourishing Colour; at the End of the third Year all these Roots were taken away, and the *Area* being a Chalk-Rock lying uncovered, round the Place where the Single Root, that produced all these, came out of the Bank, no more Roots could run out on the bare Chalk, and the Growth of the Boughs has been but little since.

Wheat, drill'd in double Rows in *November*, in a Field well till'd before Planting, look'd yellow, when about Eighteen Inches high; at Two Feet Distance from the Plants, the Earth was Ho-plow'd, which gave such Nourishment to 'em, that they recover'd their Health, and changed their sickly Yellow, to a lively Green Colour.

there, they must soon come to an End. But the Truth is, that after a few Inches, they are not discernibly taper, but pass on to their Ends very nearly of the same Bigness; this may be seen in *Roots* growing in Water, and in some other, tho' with much Care and Difficulty.

In pulling up the aforementioned *Turneps*, their Roots seem'd to end at few Inches Distance from the Plants, they being, farther off, too fine to be perceiv'd by ordinary Observation.

I found an extreme small Fibre on the Side of a *Carrot*, much less than a Hair; but thro' a Microscope it appear'd a large Root, not taper, but broken off short at the End, which it is probable might have (before broken off) extended near as far as the *Turnep* Roots did. It had many Fibres going out of it, and I have seen that a *Carrot* will draw Nourishment from a great Distance, tho' the Roots are almost invisible, where they come out of the *Carrot* itself.

By the Piece *F* Plate 6. may be seen, that those Roots cannot penetrate, unless the Land be open'd by Tillage, &c.

As Animals of different Species have their Guts bearing different Proportions to the Length of their Bodies; so 'tis probable, different Species of Plants may have their Roots as different. But if those which have shorter Roots have more in Number, and having set down the means how to know the Length of them in the Earth, I leave the different Lengths of different Species to be examin'd by those who will take the Pains of more Trials. This is enough for me, that there is no Plant commonly propagated, but what will send out its Roots far enough, to have the Benefit of all the ho'd Spaces or Intervals I in the following Chapters allot them, even tho' they should not have Roots so long as their Stalks or Stems.

And this great Length of Roots will appear very reasonable, if we compare the Largeness of the Leaves (which are the Parts ordain'd for Excretion) with the Smalness of the Capillary Roots, which must make up in Length or Number what they want in Bigness, being destin'd to range far in the Earth, to find out a Supply of Matter to maintain the whole Plant; whereas the chief Office of the Stalks and Leaves is only to receive the same, and to discharge into the Atmosphere such Part thereof as is found unfit for Nutrition; a much easier Task than the other, and consequently fewer Passages suffice, these ending in an obtuse Form; for otherwise the Air would not be able to sustain the Stalks and Leaves in their upright Posture: but the Roots, tho' very weak and slender, are easily supported by the Earth, notwithstanding their Length, Smalness, and Flexibility.

Plants have no Stomach, nor *Oesophagus*, which are necessary to convey the Mass of Food to an Animal: Which Mass, being exhausted by the Lacteals, is eliminated by way of Excrements, but the Earth itself being that Mass to the Guts (or Roots) of Plants, they have only fine Recrements, which are thrown off by the Leaves.

In this, Animal and Vegetable Bodies agree, that Guts and Roots are both injured by the open Air; and Nature has taken an equal Care, that both may be supply'd with Nourishment, without being expos'd to it. Guts are supply'd from their Insides, and Roots from their Outsides.

All the Nutriment (or *Pabulum*) which Guts receive for the Use of an Animal, is brought to them; but Roots must search out and fetch themselves all the *Pabulum* of a Plant; therefore a greater Quantity of Roots, in Length or Number, is necessary to a Plant, than of Guts to an Animal.

All *Roots* are as the Intestines of Animals, and have their Mouths or Lacteal Vessels opening on their outer

spongy Superficies, as the Guts of Animals have theirs opening in their inner spongy Superficies.

The Animal Lacteals take in their Food by the Pressure that is made from the Peristaltic Motion, and that Motion caus'd by the Action of Respiration, both which Motions press the Mouths of the Lacteals against the Mass or Soil which is within the Guts, and bring them into closer Contact with it.

Both these Motions are supply'd in Roots by the Pressure occasion'd by the Increase of their Diameters in the Earth, which presses their Lacteal Mouths against the Soil without. But in such Roots as live in Water, a Pressure is constantly made against the Roots by the Weight and Fluidity of the Water; this presses such fine Particles of Earth it contains, and which come into Contact with their Mouths, the closer to them.

And when *Roots* are in a till'd Soil, a great Pressure is made against them by the Earth, which constantly subsides, and presses their Food closer and closer, even into their Mouths; until itself becomes so hard and close, that the weak Sorts of Roots can penetrate no farther into it, unless re-open'd by new Tillage, which is call'd Hoing.

When a good Number of Single-Mint Stalks had stood in Water, until they were well stock'd with Roots from their two lower Joints, and some of them from three Joints, I set one in a Mint-Glass full of Salt Water; this Mint became perfectly dead within three Days.

Another Mint I put into a Glass of fair Water; but I immers'd one String of its Roots (being brought over the Top of that Glass into another Glass of Salt-water, contiguous to the Top of the other Glass: This *Mint* dy'd also very soon.

Of another (standing in a Glass of Water and Earth till it grew vigorously) I ty'd one single Root into a Bag, which held a Spoonful of dry Salt, adjoining to
the

the Top of the Glafs, which kill'd this ftrong Mint alfo. I found that this Salt was foon diffolv'd, tho' on the Outside of the Glafs; and tho' no Water reach'd fo high, as to be within Two Inches of the Joint which produc'd this Root: The Leaves of all thefe were falt as Brine to the Tafte.

Of another, I put an upper Root into a fmall Glafs of Ink, inftead of a Bag of Salt, in the Manner above-mention'd; this Plant was alfo kill'd by fome of the Ink Ingredients. The Blacknefs was not communicated to the Stalk, or Leaves, which inclin'd rather to a yellowifh Colour as they died, which feem'd owing to the *Copperas*.

I made a very ftrong Liquor with Water, and bruifed Seeds of *Wild-Garlick*, and, filling a Glafs therewith, plac'd the Top of it clofe to the Top of another Glafs, having in it a Mint, two or three of whole upper Roots, put into this flinking Liquor, full of the bruifed Seeds, and there remaining, it kill'd the Mint in fome time; but it was much longer in dying than the others were with Salt and Ink. It might be, becaufe thefe Roots in the *Garlick* were very fmall, and did not bear fo great a Proportion to their whole System of Roots, as the Roots, by which the other Mints were poison'd, did to theirs.

When the Edges of the Leaves began to change Colour, I chew'd many of them in my Mouth, and found at firft the ftrong aromatic Flavour of Mint, but that was foon over; and then the naufeous Tafte of *Garlick* was very perceptible to my Palate.

I obferv'd, that when the *Mint* had flood in a Glafs of Water, until it feem'd to have finish'd its Growth, the Roots being about a Foot long, and of an earthy Colour, after putting in fome fine Earth, which funk down to the Bottom, there came from the upper Joint a new Set of white Roots, taking their Courfe on the Outside of the Heap of old Roots downwards, until they reach'd the Earth at the Bottom; and then, after
some

some time, came to be of the same earthy Colour with the old ones.

Another *Mint* being well rooted from Two Joints, about Four Inches afunder; I plac'd the Roots of the lower Joint in a deep Mint-Glafs, having Water at the Bottom, and the Roots of the upper Joint into a square Box, contriv'd for the Purpose, standing over the Glafs, and having a Bottom, that open'd in the Middle, with a Hole, that shut together close to the Stalk, just below the upper Joint; then laying all these upper Roots to one Corner of the Box, I fill'd it with Sand, dry'd in a Fire-shovel, and found, that in one Night's time, the Roots of the lower Joint, which reach'd the Water at the Bottom of the Glafs, had drawn it up, and imparted so much thereof to those Roots in the Box above, that the Sand, at that Corner where they lay, was very wet, and the other three Corners dry. This Experiment I repeated very often, and it always succeeded as that did.

And for the same Purpose I prepar'd a small Trough, about two Foot long, and plac'd a Mint-Glafs under each End of the Trough; over each Glafs I plac'd a Mint, with half its Roots in the Glafs, the other half in the Trough: The Mints stood just upon the Ends of the Trough. Then I cover'd these Roots with pulveriz'd Earth, and kept the Glasses supply'd with Water; and as oft as the white fibrous Roots shot thro' the Earth, I threw on more Earth, till the Trough would hold no more; and still the white Fibres came thro', and appear'd above it; but all seem'd (as I saw by the Help of a coarse Microscope) to turn, and when they came above-ground, their Ends enter'd into it again. These two *Mints* grew thrice as large as any other *Mint* I had, which were many, that stood in Water, and much larger than those which stood in Water with Earth in it: They being all of an equal Bigness when set in, and set at the same time. Tho' these two, standing in my Chamber, never had
any

any Water in their Earth, but what those Roots, which reach'd the Water in the Glasses, sent up to the Roots, which grew in the Trough. The vast Quantity of Water these Roots sent up, being sufficient to keep all the Earth in the Troughs moist, tho' of a thousand times greater Quantity than the Roots which water'd it, makes it probable, that the Water pass'd out of the Roots into the Earth, without mixing at all with the Sap, or being alter'd to any Degree. The Earth kept always moist, and in the hot Weather there would not remain a Drop of Water in the Glasses, when they had not been fresh supply'd in two Days and one Night; and yet these Roots in the Glasses were not dry'd, tho' they stood sometimes a whole Day and Night thus in the empty Glasses. These two Mints have thus liv'd all one Summer.

Remarks on the Mints, &c.

Tho' the Vessels of Marine Plants be some ways fortify'd against the Acrimony of Salt, as Sea-fish are, yet the Mints all shew, that Salt is poison to other Plants.

The Reason why the Salts in Dung, Brine, or Urine, do not kill Plants in the Field or Garden, is, that their Force is spent in acting upon, and dividing the Parts of Earth; neither do these Salts, or at least any considerable Quantity of them, reach the Roots.

I try'd Salt to many Potatoes in the Ground being undermin'd, and a few of their Roots put into a Dish of Salt-water, they all died sooner or later, according to their Bigness, and to the Proportions the Quantity of Salt apply'd did bear to them.

By the Mints it appears, that Roots make no Distinctions in the Liquor they imbibe, whether it be for their Nourishment or Destruction; and that they do not insume what is disagreeable, or Poison to them, for lack of other Sustenance; since they were very vigorous, and well fed in the Glasses, at the time when the most inconsiderable Part of their Number

ber

ber had the Salt, Garlick, and Ink offer'd to them.

The sixth *Mint* shews, that when new Earth is apply'd to the old Roots, a Plant sends out new Roots on Purpose to feed on it: And that the more Earth is given it, the more Roots will be form'd, by the new Vigour the Plant takes from the Addition of Earth. This corresponds with the Action of Hoing; for every time the Earth is mov'd about Roots, they have a Change of Earth, which is new to them.

The seventh *Mint* proves, that there is such a Communication betwixt all the Roots, that when any of them have Water, they do impart a Share thereof to all the rest: And that the Root of the lower Joint of this *Mint* had Passages (or Vessels) leading from them, through the Stalk, to the Roots of the upper Joint; tho' the clear Stalk (through which it must have pass'd) that was betwixt these two Joints, was several Inches in Length.

This accounts for the great Produce of long tap-rooted Plants, such as *Lusfern* and *St. Foin*, in very dry Weather: for the Earth at a great Depth is always moist. It accounts also for the good Crops we have in dry Summers, upon Land that has a Clay Bottom; for there the Water is retain'd a long time, and the lower Roots of Plants which reach it, do, like those of this *Mint*, send up a Share to all the higher Roots.

If those Roots of a Plant, which lie at the Surface of the Ground, did not receive Moisture from other Roots, which lie deeper, they could be of no Use in dry Weather. But 'tis certain, that if this dry Surface be mov'd or dung'd, the Plant will be found to grow the faster, tho' no Rain falls; which seems to prove, both that the deep Roots communicate to the shallow a Share of their Water, and receive in Return from them a Share of Food; in common with all the rest of the Plant, as in the *Mints* they did.

The

The two last *Mints* shew, that when the upper Roots have Moisture (as they had in the Earth in the Trough, carried thither first by the lower Roots) they impart some of it to the lower, else these could not have continu'd plump and fresh, as they did for 24 Hours in the empty Glass. And I have since observed them to do so, in the cooler Season of the Year, for several Weeks together, without any other Water, than what the upper Roots convey'd to them, from the moist Earth above in the Trough (*a*). I know not what Time these Roots might continue to be supply'd thus in the hot Weather, because I did not try any longer, for fear of killing them.

But it must be noted, that the Depth of the Glass protected the Roots therein from the Injury of the Motion of the free Air, which would have dry'd them, if they had been out of the Glass.

In this Trough is shewn most of the Hoing Effects; *viz.* That Roots, by being broken off near the Ends, increase their Number, and send out several where one is broken off.

That the Roots increase their Fibres every time the Earth is stirr'd about them.

That the stirring the Earth makes the Plants grow the faster.

LEAVES are the Parts or Bowels of a Plant, which perform the same Office to Sap, as the Lungs of an Animal do to Blood; that is, they purify or cleanse it of the Recrements, or fuliginous Steams, received in the Circulation, being the unfit Parts of the Food; and perhaps some decay'd Particles, which fly off the

(*a*) 'Tis certain, that Roots and other Chyle-Vessels of a Plant have a free Communication throughout all their Cavities, and the Liquor in them will run towards that Part where there is least Resistance; and such is that which is the most empty, whether it be above or below; for there are no *Valves* that can hinder the Descent or Ascent of Liquor in these Vessels, as appears by the growing of a Plant in an inverted Posture.

Vessels, through which Blood and Sap do pass respectively.

Besides which Use, the Nitro-aerous Particles may there enter, to keep up the vital Ferment or Flame.

Mr. *Papin* shews, that Air will pass in at the Leaves, and out thro' the Plant at the Roots, but Water will not pass in at the Leaves; and that if the Leaves have no Air, a Plant will die; but if the Leaves have Air, tho' the Root remain in Water *in vacuo*, the Plant will live and grow.

Dr. *Grew*, in his Anatomy of Plants, mentions Vessels, which he calls, Net-work, Cobweb, Skeins of Silk, &c. but above all, the Multitude of Air-Bladders in them, which I take to be of the same Use in Leaves, as the Vesiculæ are in Lungs. Leaves being as Lungs inverted, and of a broad and thin Form; their Vesiculæ are in Contact with the free open Air, and therefore have no need of Trachea, or Bronchia, nor of Respiration.

C H A P. II.

Of FOOD of PLANTS.

THE chief Art of an Husbandman is to feed Plants to the best Advantage; but how shall he do that, unless he knows what is their Food? By Food is meant that Matter, which, being added and united to the first *Stamina* of Plants, or *Plantulæ*, which were made in little at the Creation, gives them, or rather is their Increase.

'Tis agreed, that all the following Materials contribute, in some manner, to the Increase of Plants; but 'tis disputed which of them is that very Increase or Food. 1. *Nitre.* 2. *Water.* 3. *Air.* 4. *Fire.* 5. *Earth.*

I will not mention, as a Food, that acid Spirit of the Air, so much talk'd of; since by its eating asunder Iron Bars it appears too much of the Nature of *Aqua Fortis*, to be a welcome Guest alone to the tender Vessels of the Roots of Plants.

Nitre is useful to divide and prepare the Food, and may be said to nourish Vegetables in much the same Manner as my Knife nourishes me, by cutting and dividing my Meat: But when *Nitre* is apply'd to the Root of a Plant, it will kill it as certainly as a Knife misapply'd will kill a Man: Which proves, that *Nitre* is, in respect of Nourishment, just as much the Food of Plants, as *White Arsenick* is the Food of Rats. And the same may be said of Salts.

Water, from *Van-Helmont's* Experiment, was by some great Philosophers thought to be it. But these were deceived, in not observing, that Water has always in its Intervals a Charge of Earth, from which no Art can free it. This Hypothesis having been fully confuted by Dr. *Woodward*, no body has, that I know of, maintain'd it since: And to the Doctor's Arguments I shall add more in the Article of Air.

Air, because its Spring, &c. is as necessary to the Life of Vegetables, as the Vehicle of Water is; some modern Virtuosi have affirm'd, from the same and worse Arguments than those of the Water-Philosophers, that Air is the Food of Plants. Mr. *Bradley* being the chief, if not only Author, who has publish'd this Phantasy, which at present seems to get Ground, 'tis fit he should be answer'd: And this will be easily done, if I can shew, that he has answer'd this his own Opinion, by some or all of his own Arguments.

His first is, that of *Helmont*, and is thus related in Mr. *Bradley's* general Treatise of *Husbandry and Gardening*, Vol. I. p. 36. , Who dry'd Two hundred Pounds of Earth, and planted a Willow of Five Pounds Weight in it, which he water'd with

Rain,

‘ Rain, or distill’d Water; and to secure it from any
 ‘ other Earth getting in, he covered it with a perforated Tin Cover. Five Years after, weighing the
 ‘ Tree, with all the Leaves it had borne in that Time,
 ‘ he found it to weigh One hundred Sixty-nine
 ‘ Pounds Three Ounces ; but the Earth was only diminished about two Ounces in its Weight.’

On this Experiment Mr. *Bradley* grounds his Airy Hypothesis. But let it be but examined fairly, and see what may be thence inferr’d.

The Tin Cover was to prevent any other Earth from getting in. This must also prevent any Earth from getting out, except what enter’d the Roots, and by them pass’d into the Tree.

A Willow is a very thirsty Tree, and must have drank in Five Years time several Tuns of Water, which must necessarily carry in its Interstices a great Quantity of Earth (probably many times more than the Tree’s (a) Weight, which could not get out, but by the Roots of the Willow.

Therefore the Two hundred Pounds of Earth not being increased, proves that so much Earth as was poured in with the Water, did enter the Tree.

Whether the Earth did enter to nourish the Tree, or whether only in order to pass through it (by way of Vehicle to the Air), and leave the Air behind for the Augment of the Willow, may appear by examining the Matter of which the Tree did consist.

If the Matter remaining after the Corruption or Putrefaction of the Tree be Earth, will it not be a Proof, that the Earth remained in it, to nourish and augment it? for it could not leave what it did not first take, nor be augmented by what pass’d through it. According to *Aristotle’s* Doctrine, and Mr. *Bradley’s*

(a) The Body of an Animal receives a much less Increase in Weight than its Perspirations amount to, as *Sanctorius’s Static-Chair* demonstrates.

too, in Vol. I. pag. 72. "Putrefaction resolves it
"again into Earth, its first Principle."

The Weight of the Tree, even when green, must consist of Earth and Water. Air could be no Part of it, because Air being of no greater specific Gravity than the incumbent Atmosphere, could not be of any Weight in it; therefore was no Part of the One hundred Sixty-nine Pounds Three Ounces.

Nature has directed Animals and Vegetables to seek what is most necessary to them. At the Time when the *Fetus* has a Necessity of Respiration, 'tis brought forth into the open Air, and then the Lungs are filled with Air. As soon as a Calf, Lamb, &c. is able to stand, it applies to the Teat for Food, without any Teaching. In like manner Mr. *Bradley* remarks, in his Vol. I. pag. 10. 'That almost every
'Stem and every Root are formed in a bending man-
'ner under Ground; and yet all these Stems become
'strait and upright when they come above-ground,
'and meet the Air; and most Roots run as directly
'downwards, and shun the Air as much as possible.'

Can any thing more plainly shew the Intent of Nature, than this his Remark does? *viz.* That the Air is most necessary to the Tree above ground, to purify the Sap by the Leaves, as the Blood of Animals is depurated by their Lungs: And that Roots seek the Earth for their Food, and shun the Air, which would dry up and destroy them.

No one Truth can possibly contradict or interfere with any other Truth; but one Error may contradict and interfere with another Error, *viz.*

Mr. *Bradley*, and all Authors, I think, are of Opinion, that Plants of different Natures are fed by a different Sort of Nourishment; from whence they aver, that a Crop of Wheat takes up all that is peculiar to that Grain; then a Crop of Barley all that is proper to it; next a Crop of Pease, and so on, 'till each has drawn off all those Particles which are proper

to it; and then no more of these Grains will grow in that Land, till by Fallow, Dung, and Influences of the Heavens, the Earth will be again replenish'd with new Nourishment, to supply the same Sorts of Corn over again. This, if true (as they all affirm it to be), would prove, that the Air is not the Food of Vegetables. For the Air being in itself so homogeneous as it is, could never afford such different Matter as they imagine; neither is it probable, that the Air should afford the Wheat Nourishment more one Year, than the ensuing Year; or that the same Year it should nourish Barley in one Field, Wheat in another, Pease in a Third; but that if Barley were sown in the Third, Wheat in the First, Pease in the Second, all would fail: Therefore this Hypothesis of Air for Food interferes with, and contradicts this Doctrine of Necessity of changing Sorts.

I suppose, by Air, they do not mean dry Particles of Earth, and the Effluvia which float in the Air: The Quantity of these is too small to augment Vegetables to that Bulk they arrive at. By that way of speaking they might more truly affirm this of Water, because it must be like to carry a greater Quantity of Earth than Air doth, in proportion to the Difference of their different specific Weight; Water, being about 800 times heavier than Air, is likely to have 800 times more of that terrestrial Matter in it; and we see this is sufficient to maintain some Sort of Vegetables, as Aquatics; but the Air, by its Charge of Effluvia, &c. is never able to maintain or nourish any Plant; for as to the Sedums, Aloes, and all others, that are supposed to grow suspended in the Air, 'tis a mere Fallacy; they seem to grow, but do not; since they constantly grow lighter; and tho' their Vessels may be somewhat distended by the Ferment of their own Juices which they received in the Earth, yet suspended in Air, they continually diminish in Weight (which is the true Argument of a Plant) until they grow to nothing.

nothing. So that this Instance of Sedums, &c. which they pretend to bring for Proof of this their Hypothesis, is alone a full Confutation of it.

Yet if granted, that Air could nourish some Vegetables by the earthy Effluvia, &c. which it carry'd with it (a), even that would be against them, not for them.

They might as well believe, that *Martins* and *Swallows* are nourish'd by the Air, because they live on Flies and Gnats, which they catch therein; this being the same Food, which is found in the Stomach of the Chameleon.

If, as they say, the Earth is of little other Use to Plants, but to keep them fix'd and steady, there would be little or no Difference in the Value of rich and poor Land, dung'd or undung'd; for one would serve to keep Plants fix'd and steady, very near, if not quite as well as the other.

If Water or Air was the Food of Plants, I cannot see what Necessity there should be of Dung or Tillage.

4. *Fire.* No Plant can live without Heat, tho' different Degrees of it be necessary to different Sorts of Plants. Some are almost able to keep Company with the *Salamander*, and do live in the hottest Exposures of the hot Countries. Others have their Abode with Fishes under Water, in cold Climates: for the Sun has his Influence, tho' weaker, upon the Earth cover'd with Water, at a considerable Depth; which appears by the Effect the Vicissitudes of Winter and Summer have upon subterraqueous Vegetables.

Tho' every Heat is said to be a different Degree of Fire; yet we may distinguish the Degrees by their different Effects. Heat warms; but Fire burns: The first helps to cherish, the latter destroys Plants.

(a) This is meant of dry Earth, by its Lightness (when pulveriz'd extremely fine) carried in the Air without Vapour: For the Atmosphere, consisting of all the Elements, has Earth in it in considerable Quantity, mix'd with Water; but a very little Earth is so minutely divided, as to fly therein pure from Water, which is its Vehicle there for the most Part.

5. *Earth*. That which nourishes and augments a Plant is the true Food of it.

Every Plant is Earth, and the Growth and true Increase of a Plant is the Addition of more Earth.

Nitre (or other Salts) prepares the Earth, Water and Air move it, by conveying and fermenting it in the Juices; and this Motion is called Heat.

When this additional Earth is assimilated to the Plant, it becomes an absolute Part of it.

Suppose Water, Air, and Heat, could be taken away, would it not remain to be a Plant, tho' a dead one?

But suppose the Earth of it taken away, what would then become of the Plant? Mr. *Bradley* might look long enough after it, before he found it in the Air among his specific or certain Qualities.

Besides, too much *Nitre* (or other Salts) corrodes a Plant; too much Water drowns it; too much Air dries the Roots of it; too much Heat (or Fire) burns it; but too much Earth a Plant never can have, unless it be therein wholly buried; and in that Case it would be equally misapply'd to the Body, as Air or *Nitre* would be to the Roots.

Too much Earth, or too fine, can never possibly be given to Roots; for they never receive so much of it as to surfeit the Plants, unless it be depriv'd of Leaves, which, as Lungs, should purify it.

And Earth is so surely the Food of all Plants, that with the proper Share of the other Elements, which each Species of Plants requires, I do not find but that any common Earth will nourish any Plant.

The only Difference of Soil (*a*) (except the Richness) seems to be the different Heat and Moisture it has;

(a) As I have said in my *Essay*, That a Soil being once proper to a Species of Vegetables, it will always continue to be so; it must be supposed, that there be no Alteration of the Heat and Moisture of it; and that this Difference I mean, is of its Quality
of

has ; for if those be rightly adjusted, any Soil will nourish any Sort of Plant ; for let *Thyme* and *Rushes* change Places, and both will die ; but let them change their Soil, by removing the Earth wherein the *Thyme* grew, from the dry Hill down into the watry Bottom, and plant *Rushes* therein ; and carry the moist Earth, wherein the *Rushes* grew, up to the Hill ; and there *Thyme* will grow in the Earth that was taken from the *Rushes* ; and so will the *Rushes* grow in the Earth that was taken from the *Thyme* ; so that 'tis only more or less Water that makes the same Earth fit either for the Growth of *Thyme* or *Rushes*.

So for Heat ; our Earth, when it has in the Stove the just Degree of Heat that each Sort of Plants requires, will maintain Plants brought from both the *Indies*.

Plants differ as much from one another in the Degrees of Heat and Moisture they require, as a Fish differs from a Salamander.

Indeed *Mistletoe*, and some other Plants, will not live upon Earth, until it be first alter'd by the Vessels of another Plant or Tree, upon which they grow, and therein are as nice in Food as an Animal.

There is no need to have Recourse to Transmutation ; for whether Air or Water, or both, are transform'd into Earth or not, the thing is the same, if it be Earth when the Roots take it ; and we are convinced that neither Air nor Water alone, as such, will maintain Plants.

These kind of Metamorphoses may properly enough be consider'd in Dissertations purely concerning Matter, and to discover what the component Particles of Earth are ; but not at all necessary to be known, in relation to the maintaining of Vegetables.

of nourishing different Species of Vegetables, not of the Quantity of it ; which Quantity may be alter'd by Diminution or Superinduction.

C H A P. III.

Of PASTURE of PLANTS.

CATTLE feed on Vegetables that grow upon the Earth's external Surface; but Vegetables themselves first receive, from within the Earth, the Nourishment they give to Animals.

The Pasture of Cattle has been known and understood in all Ages of the World, it being liable to Inspection; but the Pasture of Plants, being out of the Observation of the Senses, is only to be known by Disquisitions of Reason; and has (for ought I can find) pass'd undiscover'd by the Writers of Husbandry (*a*).

The Ignorance of this seems to be one principal Cause, that Agriculture, the most necessary of all Arts, has been treated of by Authors more superficially than any other Art whatever. The Food or *Pabulum* of Plants being prov'd to be Earth, where and whence (*b*) they take that, may properly be called their Pasture.

This Pasture I shall endeavour to describe.

(*a*) When Writers of Husbandry, in discoursing of Earth and Vegetation, come nearest to the Thing, that is, the *Pasture of Plants*, they are lost in the Shadow of it, and wander in a Wilderness of obscure Expressions, such as *Magnetism, Virtue, Power, Specific Quality, Certain Quality*, and the like; wherein there is no manner of Light for discovering the real Substance, but we are left by them more in the Dark to find it, than Roots are when they feed on it; And when a Man, no less sagacious than Mr. Evelyn, has trac'd it thro' all the *Mazes of the Occult Qualities*, and even up to the *Metaphysics*, he declares he cannot determine, whether the Thing he pursues be *Corporal* or *Spiritual*.

(*b*) By the *Pasture* is not meant the *Pabulum* itself; but the *Superficies* from whence the *Pabulum* is taken by Roots.

'Tis

'Tis the inner or (internal) Superficies (*a*) of the Earth; or which is the same thing, 'tis the Superficies of the Pores, Cavities, or Interfices of the divided Parts of the Earth, which are of two Sorts, viz. *Natural* and *Artificial*.

By Nature, the whole Earth (or Soil) is composed of Parts; and, if these had been in every Place absolutely joined, it would have been without Interfices or Pores, and would have had no internal Superficies, or Pasture for Plants: but since it is not so strictly dense (*b*), there must be Interfices at all those Places where the Parts remain separate and divided.

These Interfices, by their Number and Largeness, determine the specific Gravity (or true Quantity) of every Soil: The larger they are, the lighter is the Soil; and the inner Superficies is commonly the less.

The Mouths, or Lacteals, being situate, and opening, in the convex Superficies of Roots, they take their *Pabulum*, being fine Particles of Earth, from the Superficies of the Pores, or Cavities, wherein the Roots are included.

(*a*) This Pasture of Plants never having been mentioned or described by any Author that I know of, I am at a loss to find any other Term to describe it by, that may be synonymous, or equipollent to it: Therefore, for want of a better, I call it the inner, or internal Superficies of the Earth, to distinguish it from the outer or external Superficies, or Surface, whereon we tread.

Inner or internal Superficies may be thought an absurd Expression, the Adjective expressing something within, and the Substantive seeming to express only what is without it; and indeed the Sense of the Expression is so; for the Vegetable Pasture is within the Earth, but without (or on the Outfides of) the divided Parts of the Earth.

And, besides, Superficies must be joined with the Adjective Inner (or Internal) when 'tis used to describe the Inside of a thing that is hollow, as the Pores and Interfices of the Earth are.

The Superficies, which is the Pasture of Plants, is not a bare Mathematical Superficies; for that is only imaginary.

(*b*) For were the Soil as dense as Glass, the Roots or Vegetables (such as our Earth produces) would never be able to enter its Pores.

And 'tis certain, that the Earth is not divested or robb'd of this *Pabulum*, by any other Means, than by actual Fire, or the Roots of Plants.

For, when no Vegetables are suffer'd to grow in a Soil, it will always grow richer. Plow it, harrow it, as often as you please, expose it to the Sun in Horse-Paths all the Summer, and to the Frost of the Winter; let it be cover'd by Water at the Bottom of Ponds, or Ditches; or if you grind dry Earth to Powder, the longer 'tis kept exposed, or treated by these or any other Method possible (except actual Burning by Fire); instead of losing, it will gain the more Fertility.

These Particles, which are the *Pabulum* of Plants, are so very minute (*a*) and light, as not to be singly attracted to the Earth, if separated from those Parts to which they adhere (*b*), or with which they are in Contact (like Dust to a Looking-Glass, turn it upwards, or downwards, it will remain affixt to it), as these Particles do to those Parts, until from thence remov'd by some Agent.

(*a*) As to the Fineness of the *Pabulum* of Plants, 'tis not unlikely, that Roots may insume no grosser Particles, than those on which the Colours of Bodies depend; but to discover the greatest of those Corpuscles, Sir *Isaac Newton* think, it will require a Microscope, that with sufficient Distinctness can represent Objects Five or Six hundred times bigger, than at a Foot Distance they appear to the naked Eye.

My Microscope indeed is but a very ordinary one, and when I view with it the Liquor newly imbibed by a fibrous Root of a Mint, it seems more limpid than the clearest common Water, nothing at all appearing in it.

(*b*) Either Roots must insume the Earth, that is their *Pabulum*, as they find it in whole Pieces. having intire Superficies of their own, or else such Particles as have not intire Superficies of their own, but want some Part of it, which adheres to, or is Part of the Superficies of larger Particles, before they are separated by Roots. The former they cannot insume (unless contained in Water); because they would fly away at the first Pores that were open: *Ergo* they must insume the latter.

A Plant cannot separate these Particles from the Parts to which they adhere, without the Assistance of Water, which helps to loosen them.

And 'tis also probable, that the Nitre of the Air may be necessary to relax this Superficies, to render the prolific Particles capable of being thence disjoin'd; and this Action of the Nitre seems to be what is call'd, Impregnating the Earth.

Since the grosser Vegetable Particles, when they have pass'd thro' a Plant, together with their moist Vehicle, do fly up into the Air invisibly; 'tis not likely they should, in the Earth, fall off from the Superficies of the Pores, by their own Gravity: And if they did fall off, they might fly away as easily before they enter'd Plants, as they do after they have pass'd thro' them; and then a Soil might become the poorer (*a*) for all the Culture and Stirring we bestow upon it; tho' no Plants were in it; contrary to Experience.

It must be own'd, that Water does ever carry, in its Interstices, Particles of Earth fine enough to enter Roots; because I have seen, that a great Quantity of Earth (in my Experiments) will pass out of Roots set in Rain-water; and 'tis found that Water can never be, by any Art, wholly freed from its earthy Charge; therefore it must have carry'd in some Particles of Earth along with it: But yet I cannot hence conclude, that the Water did first take these fine Particles from the aforesaid Superficies: I rather think, that they are exhal'd, together with very small Pieces to which they adhere, and in the Vapour divided by the Aereal Nitre; and, when the Vapour is condens'd, they descend with it to replenish

(*a*) But we see it is always the richer by being frequently turned and exposed to the Atmosphere: Therefore Plants must take all their *Pabulum* from a Superficies of Parts of Earth; except what may perhaps be contained in Water fine enough to enter Roots intire with the Water.

the Pasture of Plants; and that these do not enter intire into Roots, neither does any other of the earthy Charge that any Water contains; except such fine Particles which have already pass'd thro' the Vegetable Vessels, and been thence exhal'd.

This Conjecture is the more probable, for that Rain-Water is as nourishing to Plants set therein as Spring-Water, tho' the latter have more Earth in it; and tho' Spring-water have some Particles in it that will enter intire into Roots, yet we must consider, that even that Water may have been many times exhal'd into the Air, and may have still retain'd a great Quantity of Vegetable Particles, which it received from Vegetable Exhalations in the Atmosphere; tho' not so great a Quantity as Rain-water, that comes immediately thence.

These, I have to do with, are the Particles which Plants have from the Earth, or Soil; but they have also fine Particles of Earth from Water, which may impart some of its finest Charge to the Superficies of Roots, as well as to the Superficies of the Parts of the Earth (*a*) which makes the Pasture of Plants.

Yet it seems, that much of the Earth, contain'd in the clearest Water, is there in too large Parts to enter a Root; since we see, that in a short time the Root's Superficies will, in the purest Water, be cover'd with Earth, which is then form'd into a terrene Pasture, which may nourish Roots; but very few Plants will live long in so thin a Pasture, as any Water affords them. I cannot find one as yet that has liv'd a Year, without some Earth have been added to it.

And all Aquatics, that I know, have their Roots in the Earth, tho' cover'd with Water.

The Pores, Cavities, or Interfices of the Earth, being of two Sorts, *viz.* *Natural* and *Artificial*; the

(*a*) If Water does separate, and take any of the mere *Pabu- lum* of Plants from the Soil, it gives much more to it.

one affords the Natural, the other the Artificial Pasture of Plants.

The natural Pasture alone will suffice, to furnish a Country with Vegetables, for the Maintenance of a few Inhabitants; but if Agriculture were taken out of the World, 'tis much to be fear'd, that those of all populous Countries, especially towards the Confines of the frigid Zones (for there the Trees often fail of producing Fruit), would be oblig'd to turn *Anthropophagi*, as in many uncultivated Regions they do, very probably for that Reason.

The artificial Pasture of Plants is that inner Superficies which is made from dividing the Soil by Art.

This does, on all Parts of the Globe, where used, maintain many more People than the natural Pasture (a); and in the colder Climates, I believe, it will not be

(a) The extraordinary Increase of St. Foin, Clover, and natural Grass, when their Roots reach into pulveriz'd Earth, exceeding the Increase of all those other Plants of the same Species (that stand out of the Reach of it) above One hundred Times, shew how vastly the artificial Pasture of Plants exceeds the natural. A full Proof of this Difference, (besides very many I have had before) was seen by two Intervals in the middle of a poor Field of worn-out St. Foin, pulveriz'd in the precedent Summer, in the manner describ'd in a Note on the latter Part of Chap. XII. relating to *St. Foin*. Here not only the *St. Foin* adjoining to these Intervals recover'd its Strength, blossom'd, and seeded well, but also the natural Grass amongst it was as strong, and had as flourishing a Colour, as if a Dung-heap had been laid in the Intervals; also many other Weeds came out from the Edges of the unplow'd Ground, which must have lain dormant a great many Years, grew higher and larger than ever were seen before in that Field; but above all, there was a Weed amongst the *St. Foin*, which generally accompanies it, bearing a white Flower; some call it *White Weed*, others *Lady's Bedstraw*: Some Plants of this that stood near the Intervals, were, in the Opinion of all that saw them, increased to a thousand Times the Bulk of those of the same Species, that stood in the Field three Feet distant from such pulveriz'd Earth.

Note, These Intervals were each an Hundred Perch long, and had each in them a treble Row of Barley very good. The Reason I take to be this, That the Land had lain still several Years after

be extravagant to say, ten times as many : Or that, in Case Agriculture were a little improved (as I hope to shew is not difficult to be done), it might maintain twice as many more yet, or the same Number, better.

The natural Pasture is not only less than the artificial, in an equal Quantity of Earth ; but also, that little consisting in the Superficies of Pores, or Cavities, not having a free Communication (*a*) with one another, being less pervious to the Roots of all Vegetables, and requiring a greater Force to break thro' their Partitions ; by that Means, Roots, especially of weak Plants, are excluded from many of those Cavities, and so lose the Benefit of them.

But the artificial Pasture consists in Superficies of Cavities, that are pervious to all Manner of Roots, and that afford them free Passage and Entertainment in and thro' all their Recesses. Roots may here extend to the utmost, without meeting with any Barriadoes in their Way.

The internal Superficies, which is the natural Pasture of Plants, is like the external Superficies or

after its artificial Pasture was lost ; whereby all the Plants in it having only the natural Pasture to subsist on, became so extremely *small and weak*, that they were not able to exhaust the Land of so great a Quantity of the (vegetable) nourishing Particles as the Atmosphere brought down to it.

And when by Pulveration the artificial Pasture came to be added to this natural Pasture (not much exhausted), and nothing at all suffered to grow out of it for above Three Quarters of a Year, it became rich enough, without any Manure, to produce this extraordinary Effect upon the Vegetables, whose Roots reached into it. How long this Effect may continue, is uncertain : but I may venture to say, it will continue until the Exhaustion by Vegetables doth over-balance the Descent of the Atmosphere, and the Pulveration.

And what I have said of any one Species of Plants in this Respect may be generally apply'd to the rest.

(*a*) None of the natural Vegetable Pasture is lost or injured by the artificial ; but on the contrary, 'tis mended by being mix'd with it, and by having a greater Communication betwixt Pore and Pore

Surface of the Earth, whereon is the Pasture of Cattle; in that it cannot be enlarg'd without Addition of more Surface taken from Land adjoining to it, by enlarging its Bounds or Limits.

But the artificial Pasture of Plants may be enlarg'd, without any Addition of more Land, or enlarging of Bounds, and this by Division only of the same Earth.

And this artificial Pasture may be increas'd in proportion to the Division of the Parts of Earth, whereof it is the Superficies, which Division may be mathematically infinite; for an Atom is nothing; neither is there a more plain Impossibility in Nature, than to reduce Matter to nothing, by Division or Separation of its Parts.

A Cube of Earth of One Foot has but Six Feet of Superficies. Divide this Cube into Cubical Inches, and then its Superficies will be increas'd Twelve times, *viz.* to Seventy-two Superficial Feet. Divide these again in like Manner and Proportion; that is, Divide them into Parts that bear the same Proportion to the Inches, as the Inches do to the Feet, and then the same Earth, which had at first no more than Six Superficial Feet, will have Eight hundred Sixty-four Superficial Feet of artificial Pasture; and so is the Soil divisible, and this Pasture increasable *ad Infinitum*.

The common Methods of dividing the Soil are these; *viz.* by *Dung*, by *Tillage*, or by both (*a*).

C H A P. IV.

Of D U N G.

ALL Sorts of Dung and Compost contain some Matter, which, when mixt with the Soil, ferments therein; and by such Ferment dissolves, crum-

(a) For *Vis Unita Fertior*.

bles, and divides the Earth very much: This is the chief, and almost only Use of Dung: For, as to the pure earthy Part, the Quantity is so very small, that, after a perfect Putrefaction, it appears to bear a most inconsiderable Proportion to the Soil it is design'd to manure: and therefore, in that respect, is next to nothing.

Its fermenting Quality is chiefly owing to the Salts wherewith it abounds; but a very little of this Salt applied alone to a few Roots of almost any Plant, will (as, in my Mint Experiments, it is evident common Salt does) kill it.

This proves, that its Use is not to nourish, but to dissolve; *i. e.* Divide the terrestrial Matter, which affords Nutriment to the Mouths of Vegetable Roots.

It is, I suppose, upon the Account of the acrimonious fiery Nature of these Salts, that the Florists have banish'd Dung from their Flower-Gardens.

And there is, I'm sure, much more Reason to prohibit the Use of Dung in the Kitchen-Garden, on Account of the ill Taste it gives to esculent Roots and Plants, especially such Dung as is made in great Towns.

'Tis a Wonder how delicate Palates can dispense with eating their own and their Beasts Ordure, but a little more putrefied and evaporated; together with all Sorts of Filth and Nastiness, a Tincture of which those Roots must unavoidably receive, that grow amongst it.

Indeed I do not admire, that learned Palates, accustom'd to the *Goût* of *Silphium*, *Garlick*, *la Chair venée*, and mortify'd Venison, equalling the Stench and Rankness of this Sort of City-Muck, should relish and approve of Plants that are fed and fatted by its immediate Contact.

People who are so vulgarly nice, as to nauseate these modish Dainties, and whose squeamish Stomachs
even

even abhor to receive the Food of Nobles, so little different from that wherewith they regale their richest Gardens, say that even the very Water, wherein a rich Garden Cabbage is boil'd, stinks; but that the Water, wherein a Cabbage from a poor undung'd Field is boil'd, has no Manner of unpleasant Savour; and that a Carrot, bred in a Dunghill, has none of that sweet Relish, which a Field-Carrot affords.

There is a like Difference in all Roots, nourish'd with such different Diet.

Dung not only spoils the fine Flavour of these our Eatables, but inquinates good Liquor. The dung'd Vineyards in *Languedoc* produce nauseous Wine; from whence there is a Proverb in that Country, That poor People's Wine is best, because they carry no Dung to their Vineyards.

Dung is observ'd to give great Encouragement to the Production of Worms; and Carrots in the Garden are much worm-eaten, when those in the Field are free from Worms.

Dung is the Putrefaction of Earth, after it has been alter'd by Vegetable or Animal Vessels. But if Dung be thoroughly ventilated and putrefy'd before it be spread on the Field (as I think all the Authors I have read direct) so much of its Salts will be spent in fermenting the Dung itself, that little of them will remain to ferment the Soil; and the Farmer who might dung One Acre in Twenty, by laying on his Dung whilst fully replete with vigorous Salts, may (if he follows these Writers Advice to a Nicety) be forced to content himself with dinging one Acre in an Hundred.

This indeed is good Advice for Gardeners, for making their Stuff more palatable and wholesome; but would ruin the Farmer who could have no more Dung than what he could make upon his Arable Farm.

For every Sort of Dung, the longer Time it ferments without the Ground, the lesser Time it has to ferment in it, and the weaker its Ferment will be.

The Reason given for this great Diminution of Dung is, that the Seeds of Weeds may be rotted, and lose their vegetating Faculty; but this I am certain of by Demonstration, that let a Dunghil remain Three Years unmov'd, though its Bulk be vastly diminish'd in that Time, and its best Quality lost, Charlock-feed will remain sound in it, and stock the Land whereon it is laid: For that Ferment which is sufficient to consume the Virtue of the stercoreous Salts, is not sufficient to destroy the vegative Virtue of Charlock-seeds, nor (I believe) of many other Sorts of Weeds.

The very Effluvia of animal Bodies, sent off by Perspiration, are so noxious as to kill the Animal that emits them, if confin'd to receive them back in great Quantity, by breathing in an Air replete with them; which appears from the soon dying of an Animal shut up in a Receiver full of Air. Yet this seems to be the most harmless of all sorts of animal Excrements the Air can be infected with. How noxious then must be the more fetid Steams of Ordure!

If a Catalogue were publish'd of all Instances from Charnel-houses (or Coemeteries) and of the pestiferous Effects, which have happen'd from the Putrefaction of dead Bodies, after great Battles, even in the open Air, no body, I believe, would have a good Opinion of the Wholsomeness of Animal Dung; for if a great Quantity do so infect the Air, 'tis likely a less may infect it in proportion to that less Quantity.

In great Cities the Air is full of these Effluvia, which in hot Climes often produce the Pestilence; and in cold Climes People are generally observ'd to live a less time, and less healthfully, in Cities, than in the Country; to which Difference, 'tis likely, that the eating unwholsome Gardenage may contribute.

This

This Dung is a fitter Food for venomous Creatures (*a*) than for edible Plants; and 'tis (no doubt) upon Account of this, that dung'd Gardens are so much frequented by Toads, which are seldom or never seen in the open undung'd Fields.

What can we say then to the Salubrity of those Roots themselves, bred up and fatten'd among these Toads and Corruption? The Leaves indeed are only discharging some of the Filth, when we eat them; but the Roots have that unfavoury infected Food in their very Mouths, when we take them for our Nourishment.

But tho' *Dung* be, upon these and other Accounts, injurious to the Garden, yet a considerable Quantity of it is so necessary to most Corn-fields, that without it little Good can be done by the old Husbandry.

Dung is not injurious to the Fields (*b*) being there in less Proportion: And the Produce of Corn is the Grain. When the Leaves have done their utmost to purify the Sap, the most refin'd Part is discern'd to be yet further elaborated by peculiar Organs; then, by the Vessels of the Blossoms, 'tis become double-refin'd, for the Nourishment of the Grain; which is therefore more pure from Dung, and more wholesome, than any other Part of the Plant that bears it.

And common Tillage alone is not sufficient for many Sorts of Corn, especially Wheat, which is the King of Grains.

Very few Fields can have the Conveniency of a sufficient Supply of Dung, to enable them to produce half the Wheat those will do near Cities, where they have Plenty of it.

(*a*) Mr. Evelyn says, that Dung is the Nurse of Vermin.

(*b*) Such Plants as *Cabbages*, *Turneps*, *Carrots*, and *Potatoes*, when they are designed only for fattening of Cattle, will not be injured by Dung, Tillage, and Hoeing all together, which will make the Crops the greater, and the Cattle will like them never the worse.

The Crop of 20 Acres will scarce make Dung sufficient for one Acre, in the common Way of laying it on.

The Action of the Dung's Ferment affords a Warmth (*a*) to the Infant-plants, in their most tender State, and the most rigorous Season.

But 'tis hard to know how long the Warmth of this Ferment lasteth, by reason of the great Difficulty to distinguish the very least Degree of Heat from the very least Degree of Cold.

Under the Name of Dung we may also understand whatever ferments with the Earth (except Fire); such as green Vegetables cover'd in the Ground, &c.

As to the Difference of the Quantity of artificial Pasture made by *Dung* without Tillage, and that made by Tillage without *Dung*; the latter is many Times greater, of which I had the following Proof. An unplow'd Land, wherein a Dunghil had lain for two or three Years, and being taken away, was planted with *Turneps*; at the same time a till'd Land, contiguous thereto, was drill'd with *Turneps*, and Horse-ho'd; the other, being Hand-ho'd, prospered best at the first; but at last did not amount to the Fifth Part of the Till'd and Horse-ho'd, in Bigness, nor in Crop. The Benefit of the Dung and Hand-hoe was so inconsiderable, in comparison of the Plough and Hoe-plough; the little Quantity of artificial Pasture raised to the other, was only near the Surface, and did not reach deep enough to maintain the *Turneps*, till they arrived at the Fifth Part of the Growth of

(*a*) But though Dung in fermenting may have a little Warmth, yet it may sometimes, by letting more Water enter its Hollowness, be in a Frost much colder than undung'd pulveriz'd Earth; for I have seen Wheat-plants in the Winter die in the very Spits of Dung, when undung'd drill'd Wheat, adjoining to it, planted at the same Time, has flourish'd all the same Winter; and I could not find any other Reason for this, but the Hollowness of the Dung; and yet it seem'd to be well rotted.

those, whose artificial Pasture reach'd to the Bottom of the Staple of the Land.

A like Proof is; that several Lands of *Turneps*, drill'd on the Level, at three Foot Rows, plow'd, and doubly dung'd, and also Horse-ho'd, did not produce near so good a Crop of *Turneps*, as Six Foot Ridges adjoining, Horse-ho'd, tho' no Dung had been laid thereon for many Years: There was no other Difference, than that the three Foot Rows did not admit the Hoe-plough to raise half the artificial Pasture, as the Six Foot Rows did. The Dung plow'd into the narrow Intervals, before drilling, could operate no further, with any great Effect, than the Hoe-plough could turn it up, and help in its Pulveration.

Dung, without Tillage, can do very little; with some Tillage doth something; with much Tillage pulverizes the Soil in less Time, than Tillage alone can do; but the Tillage alone, with more Time, can pulverize as well: This the Experiments of *artificially* pulverizing of the poorest Land, as they are related by Mr. *Evelyn*, fully prove.

And these Experiments are the more to be depended on, as they are made both in *England* and *Holland* by Persons of known Integrity.

This Truth is also further confirmed by those Authors who have found, that High-way Dust alone is a Manure preferable to Dung: And all these Pulverations being made by Attrition or Contusion, why should not our Instruments of Pulveration, in Time, reduce a sufficient Part of the Staple of a dry friable Soil, to a Dust equal to that of a Highway?

The common Proportion of Dung used in the Field pulverizes only a small Part of the Staple: but how long a time may be required for our Instruments to pulverize an equal Part, it depending much upon the Weather, and the Degree of Friability of the Soil, is uncertain.

I have seen surprising Effects from Ground, after being kept unexhausted, by plowing with common Ploughs for Two whole Years running: And I am confident, that the Expence of this extraordinary Tillage and Fallow will not, in many Places, amount to above half the Expence of a dressing with Dung; and if the Land be all the Time kept in our Sort of little Ridges of the Size most proper for that Purpose, the Expence of plowing will be diminished one half; besides the Advantage the Earth of such Ridges hath, of being friable in Weather which is too moist for plowing the same Land on the Level.

I have made many Trials of fine *Dung* on the Rows; and, notwithstanding the Benefit of it, I have, for these several Years last past, left it off, finding that a little more Hoeing will supply it at a much less Expence, than that of so small a Quantity of Manure, and of the Hands necessary to lay it on, and of the Carriage.

C H A P. V.

Of TILLAGE.

Tillage is breaking and dividing the Ground by Spade, Plough, Hoe, or other Instruments, which divide by a Sort of Attrition (or Contusion) as *Dung* does by Fermentation (*a*).

(*a*) *Neque enim aliud est Colere quam Resolvere, & Fermentare Terram.* Columella.

And since the artificial Pasture of Plants is made and increased by Pulveration, 'tis no Matter whether it be by the Ferment of *Dung*, the Attrition of the *Plough*, the Contusion of the *Roller*, or by any other Instrument or Means whatsoever, except by Fire, which carries away all the Cement of that which is burnt.

By

By Dung we are limited to the Quantity of it we can procure, which in most Places is too scanty: But by Tillage, we can enlarge our Field of subterranean Pasture without Limitation, tho' the external Surface of it be confin'd within narrow Bounds: Tillage may extend the Earth's internal Superficies, in proportion to the Division of its Parts; and as Division is infinite, so may that Superficies be.

Every Time the Earth is broken by any Sort of Tillage, or Division, there must arise some new Superficies of the broken Parts, which never has been open before. For when the Parts of Earth are once united and incorporated together, 'tis morally impossible, that they, or any of them, should be broken again, only in the same Places; for to do that, such Parts must have again the same numerical Figures and Dimensions they had before such Breaking, which even by an infinite Division could never be likely to happen: As the Letters of a Distichon, cut out and mixt, if they should be thrown up never so often, would never be likely to fall into the same Order and Position with one another, so as to recompose the same Distich.

Although the internal Superficies may have been drain'd by a preceding Crop, and the next Plowing may move many of the before divided Parts, without new-breaking them; yet such as are new-broken, have, at such Places where they are so broken, a new Superficies, which never was, or did exist before; because we cannot reasonably suppose, that any of those Parts can have in all places (if in any Places) the same Figure and Dimensions twice.

For as Matter is divisible *ad infinitum*, the Places or Lines whereat 'tis so divisible, must be, in relation to Number, infinite, that is to say, without Number; and must have at every Division Super-

ficies of Parts of infinite Variety (*b*) in Figure and Dimensions.

And because 'tis morally impossible, the same Figure and Dimensions should happen twice to any one Part, we need not wonder, how the Earth, every time of Tilling, should afford a new internal Superficies (or artificial Pasture); and that the till'd Soil has in it an inexhaustible Fund, which by a sufficient Division (being capable of an infinite one) may be produc'd.

Tillage (as well as Dung) is beneficial to all Sorts of Land (*c*). Light Land, being naturally hollow, has larger Pores, which are the Cause of its Lightness: This, when it is by any Means sufficiently divided,

(*b*) Their Variety is such, that 'tis next to impossible, any two Pieces, or Clods, in a Thousand Acres of till'd Ground, should have the same Figure, and equal Dimensions, or that any Piece should exactly tally with any other, except with that from whence it was broken off.

(*c*) 'Tis of late fully prov'd, by the Experience of many Farmers, that two or three additional Plowings will supply the Place of Dung, even in the old Husbandry, if they be perform'd at proper Seasons: and the hiring Price of three Plowings, after Land has been thrice plow'd before, is but Twelve Shillings, whereas a Danging will cost three Pounds: This was accidentally discovered in my Neighbourhood, by the Practice of a poor Farmer, who, when he had prepar'd his Land for Barley, and could not procure Seed to sow it, plow'd it on till Wheat Seed-Time, and (by means of such additional Plowing) without Dung, had so good a Crop of Wheat, that it was judg'd to be more than the Inheritance of the Land it grew on.

The same Effect follows when they prepare Land for Turneps, since they are come in Fashion, and sow them several Times upon several Plowings, the Fly as often taking them off; they have from such extraordinary Tillage a good Crop of Wheat, instead of the lost Turneps, without the Help of Dung; hence double-plowing is now become frequent in this Country.

The Reason why Land is enrich'd by lying long unplow'd, is that so very few Vegetables are carried off it, very little being produc'd; the Exhaustion is less than what is added by the Atmosphere, Cattle, &c. But when 'tis plow'd, a vastly greater Quantity of Vegetables is produc'd, and carried off, more than by the old Husbandry is return'd to it.

the Parts being brought nearer together, becomes, for a time, Bulk for Bulk, heavier; *i. e.* The same Quantity will be contain'd in less Room, and so is made to partake of the Nature and Benefits of strong Land, *viz.* to keep out too much Heat and Cold, and the like.

But strong Land, being naturally less porous, is made for a Time lighter (as well as richer) by a good Division; the Separation of its Parts makes it more porous, and causes it to take up more Room than it does in its natural State; and then it partakes of all the Benefits of lighter Land.

When strong Land is plow'd, and not sufficiently, so that the Parts remain gross, 'tis said to be rough, and it has not the Benefit of Tillage; because most of the artificial Pores (or Interstices) are too large; and then it partakes of the Inconveniences of the hollow Land untill'd.

For when the light Land is plow'd but once, that is not sufficient to diminish its natural Hollowness (or Pores;) and, for Want of more Tillage, the Parts into which 'tis divided by that once (or perhaps twice) Plowing, remain too large; and consequently the artificial Pores are large also, and, in that respect, are like the ill-till'd strong Land.

Light-land, having naturally less internal Superficies, seems to require the more Tillage (*d*) or Dung
to

(*d*) As for puffy Land, which naturally swells up, instead of subsiding, tho' its Hollowness is much abated by Tillage, yet it is thought little better than barren Land, and unprofitable for Corn: But what we usually call Light-land, is only comparatively so, in Respect of that which is heavier and stronger. And this Sort of Light land becomes much lighter by being ill-till'd; the unbroken Pieces of Turf underneath undissolved, forming large Cavities, increase its Hollowness, and consequently its Lightness: I have often known this Sort of Land despis'd by its Owners, who fear'd to give it due Tillage, which they thought would make it so light, that the Wind would blow it away; but whenever such has been thoroughly till'd, it never fail'd to become

to enrich it ; as when the poor, hollow, thin Downs have their upper Part (which is the best) burnt, whereby all. (except a *Caput Mortuum*) is carried away ; yet the Salts of this spread upon that barren Part of the Staple, which is unburnt, divide it into so very minute Particles, that their Pasture will nourish two or three good Crops of Corn : But then the Plough, even with a considerable Quantity of Dung, is never able afterwards to make a Division equal to what those Salts have done ; and therefore such burnt Land remains barren.

Artificial Pores cannot be too small, because Roots may the more easily enter the Soil that has them, quite contrary to natural Pores ; for these may be, and generally are, too small, and too hard for the Entrance of all weak Roots, and for the free Entrance of strong Roots.

Insufficient Tillage leaves strong Land with its natural Pores too small, and its artificial ones too large. It leaves Light-land, with its natural and artificial Pores both too large.

Pores that are too small in hard Ground, will not easily permit Roots to enter them.

Pores that are too large in any Sort of Land, can be of little other Use to Roots, but only to give them Passage to other Cavities more proper for them ; and if in any Place they lie open to the Air, they are dry'd up, and spoil'd, before they reach them.

much stronger than before ; and considering that 'tis till'd with less Expence than very strong Land, it is, for several Sorts of Corn, found to be more profitable than Land of greater Strength and Richness, that is more difficult to be till'd.

And I am apt to think, that this Sort of Light-land acquires more Cement, by having its *external* Superficies often changed, and exposed to the Dews, and other Benefits of the Atmosphere, as well as by the Increase of (its *internal* Superficies, which is the Surfaces of all the divided Parts of Earth, or) the Pasture of Plants ; the one being augmented by the other ; *i. e.* that into the more Parts the Earth is broken, the more Cement will it attain, from the Sulphur, which is brought by the Dews.

For

For fibrous Roots (which alone maintain the Plant; the other Roots serve for receiving the Chyle from them, and convey it to the Stem) can take in no Nourishment from any Cavity, unless they come into Contact with (*e*), and press against, all the Superficies of that Cavity, which includes them; for it dispenses the Food to their Lacteals by such Pressure only: But a fibrous Root is not so press'd by the Superficies of a Cavity whose Diameter is greater than that of the Root.

The Surfaces of great Clods form Declivities on every Side of them, and large Cavities, which are as Sinks to convey, what Rain and Dew bring, too quickly downwards to below the plow'd Part.

The first and second Plowings with common Ploughs scarce deserve the Name of Tillage; they rather serve to prepare the Land for Tillage.

The third, fourth, and every subsequent Plowing, may be of more Benefit, and less Expence, than any of the preceding ones.

(*e*) Roots cannot have any Nourishment from Cavities of the Earth that are too large to press against them, except what Water, when 'tis in great Quantity, brings to them, which is imbibed by the gentle Pressure of the Water; but when the Water is gone, those large Cavities being empty, the Pressure ceases; and this is the Reason, that when Land has few other but such large Cavities, the Plants in it always suffer more by dry Weather, than in Land which by Dung or Tillage has more minute and fewer large Cavities.

There may be some Moisture on the Superficies of large Cavities; but without Pressure the fibrous Roots cannot reach it; and very little or no Pressure can be made to one Part of the Root's Superficies, unless the Whole that is included be pressed.

If it be objected that a Charlock-Plant, when pulled up, and thrown upon the Ground, will grow thereon; this proves nothing against the Necessity of Pressure, &c. for the Weight of that Plant presses some of its Roots so closely against the Ground, that they send out (unless the Weather be very dry) new Fibres into the Earth; and there they are pressed in all their Superficies; without which Fibres the Plant doth not grow.

But

But the last Plowings will be more advantageously perform'd by Way of Hoeing, as in the following Chapters will appear.

For the finer Land is made by Tillage, the richer will it become, and the more Plants it will maintain.

It has been often observ'd, that when Part of a Ground has been better till'd than the rest, and the whole Ground constantly manag'd alike afterwards for six or seven Years successively; this Part that was but once better till'd, always produc'd a better Crop than the rest, and the Difference remain'd very visible every Harvest.

One Part being once made finer, the Dews did more enrich it; for they penetrate within and beyond the Superficies, whereto the Roots are able to enter: The fine Parts of the Earth are impregnate, throughout their whole Substance, with some of the Riches carried in by the Dews, and there repositied; until, by new Tillage, the Insides of those fine Parts become Superficies; and as the Corn drains them, they are again supply'd as before; but the rough large Parts cannot have that Benefit; the Dews not penetrating to their Centres, they remain poorer.

I think nothing can be said more strongly to confirm the Truth of this, than what is related by the Authors quoted by Mr. *Evelyn* (*f*), to this Effect, *viz.*

‘ Take of the most barren Earth you can find,
 ‘ pulverize it well, and expose it abroad for a Year,
 ‘ incessantly agitated (*g*); it will become so fertile as
 ‘ to receive an exotic Plant from the furthest *Indies*;
 ‘ and to cause all Vegetables to prosper in the most
 ‘ exalted Degree, and to bear their Fruit as kindly
 ‘ with us as in their natural Climates.’

(*f*) In Pag. 17, 18, and 19, of his *Phil. Discourse of Earth.*

(*g*) *i. e.* Stirr'd often.

This artificial Dust (*b*), he says, will entertain Plants which refuse Dung, and other violent Applications; and that it has a more nutritive Power than any artificial Dungs or Compost whatsoever: And further, that by this Toil of pulverizing, “ ’tis found, that
 “ Soil may be so strangely alter’d from its former
 “ Nature, as to render the harsh and most uncivil
 “ Clay (*i*) obsequious to the Husbandmen, and to
 “ bring forth Roots and Plants, which otherwise re-
 “ quire the lightest and hollowest Mould (*k*).”

’Tis to be suppos’d, that the *Indian* Plants had their due Degrees of Heat and Moisture given them; and I should not chuse to bestow this Toil upon the poorest of Earth in a Field or Garden, tho’ that be the most sure wherein to make the Experiment (*l*).

I never myself try’d this way of pounding or grinding, because impracticable in the Fields.

But I have had the Experience of a Multitude of Instances, which confirm it so far, that I am in no

(*b*) Tho’ it may be impossible for the Plough to reduce the whole Staple into so fine Powder, yet the more internal Superficies it makes, the more Dust will be made by the Atmosphere in Proportion; and great Clods perhaps are of no Use to Plants, but by that Dust they let fall, being thence extricated by the insensible Ferment of the nitrous Air; and the Surfaces of this artificial Dust must receive such Operations from the Air, before the utmost Fertility be obtain’d.

(*i*) But I take harsh uncivil Clay to be the least profitable of any to keep in Tillage.

(*k*) To this Dust, *Namque hoc imitamur arando* ought to be apply’d, and not to *Putre Solum*, which itself needs Tillage, as well as strong Land: Put it seems the Antients did not observe the Difference between natural Pores (or Hollowness) and artificial ones, tho’ it is very great; as is shewn in Chap. of *Pasture of Plants*: ’Tis easier indeed to imitate this artificial Dust in *hollow* than in *strong* Land.

(*l*) This is the most proper Trial of the Effect of Pulveration by *pounding* and *grinding*; but Land may be so barren, that Plough or Spade may not be sufficient to pulverize it to that Degree, which is necessary to give it the same Fertility, that Pounding in a Mortar, or grinding betwixt Marbles (as Colours are ground), can.

Doubt,

Doubt, that any Soil (*m*) (be it rich or poor) can ever be made too fine by Tillage (*n*).

For 'tis without Dispute, that one cubical Foot of this minute Powder may have more internal Superficies, than a thousand cubical Feet of the same, or any other Earth till'd in the common Manner; and, I believe no two arable Earths in the World do exceed one another in their natural Richness Twenty Times; that is, one cubical Foot of the richest is not able to produce an equal Quantity of Vegetables, *cæteris paribus*, to Twenty cubical Feet of the poorest;

(*m*) Land that is too hollow and light, having no Cement to join its Parts together, tho' in Nature they are capable of infinite Division, yet in Practice the Plough cannot divide them to any Purpose, unless they were first join'd, but glides through without breaking them; being more like to the primary Particles of Water against the Plough, which are broken by no Force, than to Earth; it may be moved, but not broken by Tillage, and therefore ought not to be reputed arable; nor does it indeed deserve the Name of Land, but as the desert Sands of *Lybia*, to distinguish it from Sea.

(*n*) According to some, this Rule is only general, and not universal; for, say they, there's a Sort of binding Gravel, that, when it is made *fine*, will, by a sudden Dash of Rain, run together like a Metal; and I have seen the same Accident in a particular Sort of *white* Land; but this very rarely happens to the latter: I never knew it above once, and that was after Barley was sown on it; the Hardness was only like a very thin Ice upon the Surface, which was some Hindrance to the coming up of the Barley, until the Harrow's going over it once or twice broke that Ice or Crust, and then it came up very well.

I never had any other Sort of Land liable to this Misfortune: therefore can say nothing to the Gravel in that Case, nor how deep the *Constipation* may reach in it, nor what Remedy is most proper to prevent the ill Consequence of it: But if there should be two or three Exceptions out of *One thousand Seventy-nine Millions One thousand and Sixty different Sorts of Earth* (see *Mr. Evelyn's Terra*, p. 2), 'twill be no great Matter.

But I think these are no real Exceptions against any Degree of *Pulverizing*; for it only shews, that some Sorts of Land, tho' very few, are subject by Accident to lose too soon their Pulveration: And if the Fineness were no Benefit to that Land, such Loss of it would be no Injury to it.

therefore

therefore 'tis not strange, that the poorest, when by pulverizing it has obtain'd One hundred Times the internal Superficies of the rich untill'd Land, it should exceed it in Fertility; or, if a Foot of the poorest was made to have Twenty Times the Superficies of a Foot of such rich Land, the poorest might produce an equal Quantity of Vegetables with the rich (*o*). Besides, there is another extraordinary Advantage, when a Soil has a larger internal Superficies in a very little Compass; for then the Roots of Plants in it are better supply'd with Nourishment, being nearer to them on all Sides within Reach, than it can be when the Soil is less fine, as in common Tillage; and the Roots in the one must extend much further than in the other, to reach an equal Quantity of Nourishment: They must range and fill perhaps above twenty Times more Space to collect the same Quantity of Food.

But in this fine Soil, the most weak and tender Roots have free Passage to the utmost of their Extent, and have also an easy, due, and equal Pressure everywhere, as in Water.

(*o*) And very poor Land, well pulveriz'd, will produce better Corn than very rich will do, without Manure or Tillage. The Experiment may be made by paring off the Turf, and setting Corn in the whole Ground that is very rich; and that will shew how much the natural Pasture of the rich is inferior to the artificial Pasture of the poor Land; but then the *poor* must have this Proportion of Excess of internal Superficies continued to it, during the whole Time of their Growth, which cannot be done without frequently repeated Divisions of the Soil by Hoeing or Manure; else it might require forty Times the internal Superficies at the Time of Sowing, to keep twenty Times the internal Superficies of the *rich* till Harvest: For although the rich is continually losing some of its artificial Pasture, as well as the *poor*, yet by losing this equally, they still draw nearer and nearer to the first Inequality of their natural Pasture.

But *poor* Land, being lighter, has this Advantage, that it being more *friable* than the strong, requires less Labour to pulverize it; and therefore the Expence of it is much less, than in proportion to the Excess of Poorness of its internal Superficies.

Hard Ground makes a too great Resistance, as Air makes a too little Resistance, to the Superficies of Roots.

Farmers, just when they have brought their Land into a Condition fit to be further till'd to much greater Advantage, leave off, supposing the Soil to be fine enough, when, with the Help of Harrows, they can cover the Seed; and afterwards with a Roller they break the Clods; to the End that, if a Crop succeed, they may be able to mow it, without being hinder'd by those Clods: By what I could ever find, this Instrument, call'd a Roller, is seldom beneficial to good Husbands; it rather untills the Land, and anticipates the subsiding of the Ground, which in strong Land happens too soon of itself (*p*).

But more to blame are they, who neglect to give their Land due Plowing, trusting to the Harrow to make it fine; and when they have thrown in their Seed, go over it twenty Times with the Harrows (*q*) till the Horses have trodden it almost as hard as a Highway, which in moist Weather spoils the Crop; but on the contrary, the very Horses, when the Earth is moist, ought all to tread in the Furrows only, as in plowing with a Hoe-Plough they always do, when they use it instead of a common Plough.

(*p*) This Injury the Roller does, is only when tis used to press down the Earth after the Seed is sown; and is the greater, if Land be moist; but the Rolling of it in dry Weather, when 'tis to be immediately plow'd up again, is the most speedy Way to pulverize the Soil; and the Harrow is then very useful in pulling up the Clods, to the End that the Roller may the better come at them to crush them.

(*q*) *Nam veteres Romani dixerunt male subactum Agrum, qui satis Frugibus occandus sit.*

Sed ut compluribus Iterationibus sic resolvatur veruactum in Pulverem, ut nullam vel exiguam desideret Occationem, cum seminaverimus. Col. Lib. 2. Cap. 4.

C H A P. VI.

Of HOEING.

HOEING is the breaking or dividing the Soil by Tillage, whilst the Corn or other Plants are growing thereon.

It differs from common Tillage (which is always perform'd before the Corn or Plants are sown or planted) in the Times of performing it; 'tis much more beneficial; and 'tis perform'd by different Instruments.

Land that is before Sowing tilled never so much (tho' the more 'tis till'd the more it will produce) will have some Weeds, and they will come in along with the Crop for a Share of the Benefit of the Tillage, greater or less, according to their Number, and what Species they are of.

But what is most to be regarded is, that as soon as the Ploughman has done his Work of plowing and harrowing, the Soil begins to undo it, inclining towards, and endeavouring to regain, its natural specific Gravity; the broken Parts by little and little coalesce, unite, and lose some of their Surfaces; many of their Pores and Interstices close up during the Seed's Incubation and Hatching in the Ground; and, as the Plants grow up, they require an Increase of Food proportionable to their increasing Bulk; but on the contrary, instead thereof, that internal Superficies, which is their artificial Pasture, gradually decreases.

The Earth is so unjust to Plants, her own Off-spring, as to shut up her Stores in proportion to their Wants; that is, to give them less Nourishment when they have need of more: Therefore Man, for whose Use they are chiefly design'd, ought to bring in his reasonable

fonable Aid for their Relief, and force open her Magazines with the Hoe, which will thence procure them at all times Provisions in Abundance, and also free them from Intruders; I mean, their spurious Kindred, the Weeds, that robb'd them of their too scanty Allowance.

There's no Doubt, but that one third Part of the Nourishment raised by Dung and Tillage, given to Plants or Corn at many proper Seasons, and appor-tion'd to the different Times of their Exigencies, will be of more Benefit to a Crop, than the Whole apply'd, as it commonly is, only at the time of Sowing. This old Method is almost as unreasonable as if Treble the full Stock of Leaves, necessary to maintain Silk-worms till they had finished their Spinning, should be given them before they are hatched, and no more afterwards.

Next to Hoeing, and something like it, is Trans-planting, but much inferior; both because it requires a so much greater Number of Hands, that by no Contrivance can it ever become general, nor does it succeed, if often repeated; but Hoeing will maintain any Plant in the greatest Vigour 'tis capable of, even unto the utmost Period of Age. Besides, there is Danger in removing a whole Plant, and Loss of Time before the Plant can take Root again, all the former Roots being broken off at the Ends in taking up (for 'tis impossible to do it without), and so must wait until by the Strength and Virtue of its own Sap (which by a continual Perspiration is daily enfeebled) new Roots are form'd, which, unless the Earth continue moist (a), are so long in forming, that they not only

(a) But when the Earth doth continue moist, many transplanted Vegetables thrive better than the same Species planted in Seeds, because the former, striking Root sooner, have a greater Advantage of the fresh-pulveriz'd Mould, which loses some of its artificial Pasture before the Seeds have Roots to reach it. The same Advantage also have Seeds by soaking till ready to sprout before they are planted. To both these the Moisture of the Earth is necessary.

find a more difficult Reception into the closing Pores ; but many Times the Plant languishes and dies of an Atrophy, being starv'd in the midst of Plenty ; but whilst this is thus decaying, the hoed Plant obtains a more flourishing State than ever, without removing from the same Soil that produc'd it.

'Tis observ'd that some Plants are the worse for Transplanting (a). *Fenochia* removed is never so good and tender as that which is not, it receives such a Check in Transplanting in its Infancy ; which, like the Rickets, leaves Knots that indurate the Parts of the Fennel, and spoil it from being a Dainty.

Hoeing has most of the Benefits without any Inconveniences of Transplanting ; because it removes the Roots by little and little, and at different Times ; some of the Roots remaining undisturb'd, always supply the moved Roots with Moisture, and the whole Plant with Nourishment sufficient to keep it from fainting, until the moved Roots can enjoy the Benefit of their new Pasture, which is very soon.

Another extraordinary Benefit of the new Hoeing (b) Husbandry is, that it keeps Plants moist in dry Weather, and this upon a double Account.

(a) As most long Tap-rooted Plants are ; for I have often try'd the Transplanting of Plants, of *St. Foin* and *Luferne* ; and could never find, that any ever came near to the Perfection that those will do which are not removed, being equally single.

Tap-rooted Grasses and Turneps are always injur'd by Transplanting ; their long Root once broken off never arrives at the Depth it would have arriv'd unbroken ; as for this Reason they cut off the Tap-root of an Apple-tree, to prevent its running downward, by which it would have too much Moisture.

(b) Hoeing may be divided into Deep, which is our Horse-hoeing, and Shallow, which is the English Hand hoeing ; and also the Shallow Horse-hoeing, used in some Places betwixt Rows, where the Intervals are very narrow, as sixteen or eighteen Inches ; this is but an Imitation of the Hand-hoe, or a *Succedaneum* to it ; and can neither supply the Use of Dung, nor of Fallow, and may be properly called Scratch-hoeing.

First, as they are better nourished by Hoeing, they require less Moisture, as appears by Dr. *Woodward's* Experiment, that those Plants which receive the greatest Increase, having most terrestrial Nourishment, carry off the least Water in Proportion to their Augment: So Barley or Oats, being sown on a Part of a Ground very well divided by Dung and Tillage, will come up and grow vigorously without Rain, when the same Grains, sown at the same Time, on the other Part, not thus enriched, will scarce come up; or, if they do, will not thrive till Rain comes.

Secondly, The Hoe, I mean the Horse-hoe (the other goes not deep enough), procures Moisture to the Roots from the Dews, which fall most in dry Weather; and those Dews (by what Mr. *Thomas Henshaw* has observ'd) seem to be the richest Present the Atmosphere gives to the Earth; having, when putrefy'd in a Vessel, a black Sediment like Mud at the Bottom. This seems to cause the darkish Colour to the upper Part of the Ground. And the Sulphur, which is found in the Sediment of the Dew, may be the chief Ingredient of the Cement of the Earth; Sulphur being very glutinous, as Nitre is dissolvent. Dew has both these.

These enter in proportion to the Fineness and Freshness of the Soil, and to the Quantity that is so made fine and fresh by the Hoe. How this comes to pass, and the Reason of it, are shewn in the Chapter of Tillage.

To demonstrate that Dews moisten the Land when fine, dig a Hole in the hard dry Ground, in the driest Weather, as deep as the Plough ought to reach: Beat the Earth very fine, and fill the Hole therewith; and, after a few Nights Dews, you'll find this fine Earth become moist at the Bottom, and the hard Ground all round will continue dry.

Till a Field in Lands; make one Land very fine by frequent deep Plowings; and let another be rough by insufficient Tillage, alternately; then plow the whole Field cross-ways in the driest Weather, which has continued long; and you will perceive, by the Colour of the Earth, that every fine Land will be turn'd up moist; but every rough Land will be dry as Powder, from Top to Bottom.

Altho' hard Ground, when thoroughly soak'd with Rain, will continue wet longer than fine till'd Land adjoining to it; yet this Water serves rather to chill, than nourish the Plants standing therein, and to keep out the other Benefits of the Atmosphere, leaving the Ground still harder when 'tis thence exhaled; and being at last once become dry, it can admit no more Moisture, unless from a long-continued Deluge of Rain, which seldom falls till Winter, which is not the Season for Vegetation.

As fine hoed Ground is not so long soaked by Rain, so the Dews never suffer it to become perfectly dry: This appears by the Plants, which flourish and grow fat in this, whilst those in the hard Ground are starved, except such of them, which stand near enough to the hoed (a) Earth, for the Roots to borrow Moisture and Nourishment from it.

And

(a) As when Wheat is drill'd late in very poor Land, so that in the Spring the young Plants look all very yellow; let your Hoe-plough, making a crooked Line, like an Indenture, on one Side of a strait Row of this poor Wheat in the Spring, turn a Furrow from it; and in a short time you will see all those yellow Plants, that are contiguous to this Furrow, change their yellow Colour to a deep Green; whilst those Plants of the same Row, which stand farthest off from this indented Furrow, change not their Colour till afterwards; and all the Plants change or retain their Colour sooner or later gradually, as they stand nearer to, or farther from it; and the other Rows, which have no Furrow near them, continue their yellow, after all this Row is become green and flourishing: But this Experiment is best to be made in poor sandy Ground, when the Mould is friable; else perhaps the differ-

And I have been informed by some Persons, that they have often made the like Observations; that, in the driest of Weather, good Hoeing (*a*) procures Moisture to Roots; tho' the Ignorant and Incurious fancy, it lets in the Drought; and therefore are afraid to hoe their Plants at such Times, when, unless they water them, they are spoil'd for Want of it.

There is yet one more Benefit Hoeing gives to Plants, which by no Art can possibly be given to Animals: For all that can be done in feeding an Animal is, what has been here already said of Hoeing; that is, to give it sufficient Food, Meat and Drink, at the times it has occasion for them; if you give an Animal any more, 'tis to no manner of Purpose, unless you could give it more Mouths, which is impossi-

ent Colour may not appear until the Furrow be turn'd back to the Row, having lain some time to be somewhat pulveriz'd (or impregnated) by the Weather, &c.

This Experiment I often made on Wheat drill'd on the Level before I drill'd any on Ridges.

The plowing one Furrow in sandy or mellow Ground makes a Pulveration, which is enjoy'd first by those Plants that are the nearest to it; and also delivers them from the Weeds, which, though there may be very few, yet there is a vast difference between their robbing the Wheat of its Pasture in the Row, and the Wheat's enjoying both that and the whole Pasture of the Furrow also.

I never remember to have seen a Plant poor, that was contiguous to a well-hoed Interval, unless overpower'd by a too great Multitude of other Plants; and the same Exception must be made, if it were a Plant that required more or less Heat or Moisture, than the Soil or Climate afforded.

(*a*) When Land is become hard by lying too long unhoed, the Plough in turning a deep Furrow from each Side of a single Row of young Plants (suppose of Turneps) may crack the Earth quite through the Row, and expose the Roots to the open Air and Sun in very dry Weather; but if the Part wherein the Plants stand be free, there will be no Cracks in it: 'Tis therefore the delaying the Hoeing too long that occasions the Injury. But to hoe with Advantage against dry Weather, the Ground must have been well tilled or hoed before, that the Hoe may go deep, else the Dews, that fall in the Night, will be exhald back in the Heat of the Day.

ble; but in hoeing a Plant the additional Nourishment thereby given, enables it to send out innumerable additional Fibres and Roots, as in one of the Glasses with a Mint in it, is seen; which fully demonstrates, that a Plant increaseth its Mouths, in some Proportion to the Increase of Food given to it: So that Hoeing, by the new Pasture it raises, furnishes both Food and Mouths to Plants; and 'tis for Want of Hoeing, that so few are brought to their Growth and Perfection (a)

In what Manner the Sarrition of the Antients was performed in their Corn, is not very clear: This seems to have been their Method; *viz.* When the Plants were some time come up, they harrowed the Ground, and pull'd out the Weeds by Hand. The Process of this appears in *Columella*, where he directs the Planting of *Medica* to be but a Sort of Harrowing or Raking amongst the young Plants, that the Weeds might come out the more easily: *Lignis Rastris statim jacta Semina obruantur. Post Sationem Lignis Rastris jarriendus, & identidem runcandus est Ager, ne alterius generis Herba invalidam Medicam perimat.*

(a) A Ground was drill'd with Ray-grass and Barley, in Rows at Five Inches Distance from each other; it produced a pretty good Crop of Ray-grass the second Year as is usual; there was adjoining to it a Ground of Turneps, that were in Rows, with wide Intervals Horse-ho'd; they stood for Seed; and amongst them there was, in Room of a Turnep, a single Plant of Ray-grass, which, being hoed as the Turneps were, had (in every one's Opinion that saw it) acquired a Bulk at least equal to a Thousand Plants of the same Species in the other Ground; tho' that vast Plant had no other Advantage above the other, except its Singleness, and the deep Hoeing.

I have seen a Chickweed, by the same means, as much increas'd beyond its common Size; and a Plant of Mustard-feed, whose collateral Branches were much bigger than ever I saw a whole Plant of that Sort; it was higher than I could reach its Top, and indeed more like a Tree than an Herb; many other sorts of Plants have I seen thus increas'd beyond what I had ever observ'd before, but none so much as those.

They harrowed and hoed *Rastris*; so that their *Occatio* and *Sarritio* were performed with much the same Sort of Instrument, and differed chiefly in the Time: The first was at Seed-time, to cover the Seed, or level the Ground; the other was to move the Ground after the Plants were up.

One Sort of their Sarrition was, *Segetes permota Terra debere adobruī, ut fruticare possint*. Another Sort was thus: *In Locis autem frigidis sarriri nec adobruī, sed Plana Sarritione Terram permoveri*.

For the better Understanding of these two Sorts of Sarrition, we must consider, that the Antients sowed their Corn under Furrow; that is, when they had harrowed the Ground, to break the Clods, and make it level, they sowed the Seed, and then plowed it in: This left the Ground very uneven, and the Corn came up (as we see it does here in the same Case) mostly in the lowest Places betwixt the Furrows, which always lay higher: This appears by *Virgil's Cum Sulcos equant Sata*. Now, when they used *Plana Sarritio*, they harrowed Length-ways of the Furrows, which being somewhat harden'd, there could be little Earth thrown down thence upon the young Corn.

But the other Sort of Sarrition, whereby the Corn is said *Adobruī*, to be cover'd, seems to be perform'd by Harrowing cross the Furrows; which must needs throw down much Earth from the Furrows, which necessarily fell upon the Corn.

How this did contribute to make the Corn *fruticare*, is another Question: I am in no doubt to say, it was not from covering any Part of it (for I see that has a contrary Effect), but from moving much Ground, which gave a new Pasture to the Roots: This appears by the Observation of the extraordinary Frutication of Wheat ho'd without being cover'd, and by the Injury it receives by not being uncover'd when any Earth falls on the Rows.

The same Author saith, *Faba, & cætera Legumina, cum quatuor Digitis à Terra extiterint, recte sarrientur, excepta*

excepto tamen Lupino, cujus Semini contraria est Sarritio; quoniam unam Radicem habet, quæ sive Ferro succisa seu vulnerata est, totus Frutex emoritur.

If they had ho'd it only betwixt Rows, there had been no Danger of killing the Lupine, which is a Plant most proper for Hoeing. What he says of the Lupine's having no need of Sarrition, because it is able of itself to kill Weeds, shews the Antients were ignorant of the chief Use of Hoeing; *viz.* to raise new Nourishment by dividing the Earth, and making a new Internal Superficies in it.

Sarrition scratched and broke so small a Part of the Earth's Surface, amongst the Corn and Weeds, without Distinction, or favouring one any more than the other, that it was a Dispute, whether the Good it did in facilitating the Runcation (or Hand-weeding) was greater, than the Injury it did by bruising and tearing the Corn: And many of the Antients chose rather to content themselves with the Use of Runcation only, and totally to omit all Sarrition of their Corn.

But Hoeing is an Action very different from that of Sarrition, and is every Way beneficial, no-way injurious to Corn, tho' destructive to Weeds. Therefore some modern Authors shew a profound Ignorance, in translating *Sarritio*, Hoeing: They give an Idea very different from the true one: For the Antients truly hoed their Vineyards, but not their Corn; neither did they plant their Corn in Rows, without which they could not give it the Vineyard-hoeing: Their Sarculation was used but amongst small Quantities of sown Corn, and is yet in Use for Flax; for I have seen the *Sarculum* (which is a Sort of a very narrow Hoe) used amongst the Plants of Flax standing irregularly: But this Operation is too tedious and too chargeable, to be apply'd to great Quantities of irregular Corn.

If they ho'd their Crops sown at Random, one would think they should have made mad Work of

it; since they were not at the Pains to plant in Rows, and hoe betwixt them with their Bidens; being the Instrument with which they tilled many of their Vineyards, and enters as deep as the Plough, and is much better than the *Englifo* Hoe, which indeed seems, at the first Invention of it, to be designed rather to scrape Chimneys, than to till the Ground.

The highest and lowest Vineyards are ho'd by the Plough; first the high Vineyards, where the Vines grow (almost like Ivy) upon great Trees, such as Elms, Maples, Cherry-trees, &c. These are constantly kept in Tillage, and produce good Crops of Corn, besides what the Trees do yield; and also these great and constant Products of the Vines are owing to this Sort of Hoe-tillage; because neither in Meadow or Pasture Grounds can Vines be made to prosper; tho' the Land be much richer, and yet have a less Quantity of Grass taken off it, than the Arable has Corn carried from that.

The Vines of low Vineyards (*a*), ho'd by the

(*a*) From these I took my Vineyard Scheme, observing that indifferent Land produces an annual Crop of Grapes and Wood without Dung; and though there is annually carried off from an Acre of Vineyard, as much in Substance as is carried off in the Crop of an Acre of Corn produced on Land of equal Goodness; and yet the Vineyard Soil is never impoverished, unless the hoeing Culture be denied it: But a few annual Crops of Wheat, without Dung in the common Management, will impoverish and emaciate the Soil.

The Vine indeed has the Advantage of being a large perennial Plant, and of receiving some Part of its Nourishment below the Staple; but it has also Disadvantages: The Soil of the Vineyard never can have a true Summer Fallow, tho' it has much Summer Hoeing; for the Vines live in it, and all over it all the Year: neither can that Soil have Benefit from Dung, because though by increasing the Pulveration, it increases the Crop, yet it spoils the Taste of the Wine; the Exhaustion of that Soil is therefore supply'd by no artificial Help but Hoeing: And by all the Experience I have had of it, the same Cause will have the same Effect upon a Soil for the Production of Corn, and other Vegetables, as well as upon the Vineyard.

Plough,

Plough, have their Heads just above the Ground, standing all in a most regular Order, and are constantly plowed in the proper Season: These have no other Assistance, but by Hoeing; because their Head and Roots are so near together, that Dung would spoil the Taste of the Wine they produce, in hot Countries.

All Vineyards must be ho'd one Way or other (*a*), or else they will produce nothing of Value; but Corn Fields without Hoeing do produce something, tho' nothing in Comparison to what they would do with it.

Mr. *Evelyn* says, that when the Soil, wherein Fruit-Trees are planted, is constantly kept in Tillage, they grow up to be an Orchard in half the Time they would do, if the Soil were not till'd; and this keeping an Orchard-Soil in Arable, is Horse-hoeing it.

In some Places in *Berkshire* they have used, for a long time to Hand-hoe most Sorts of Corn, with very great Success; and I may say this, that I myself never knew, or heard, that ever any Crop of Corn was properly so ho'd, but what very well answer'd the Expence, even of this Hand-work; but be this never so profitable, there are not a Number of Hands to use it in great Quantities; which possibly was one Reason the Antients were not able to introduce it into their Corn-Fields to any Purpose; tho' they should not have been ignorant of the Effect of it, from what they saw it do in their Vineyards and Gardens.

In the next Place I shall give some general Directions, which by Experience I have found necessary to be known, in order to the Practice of this Hoeing-Husbandry.

- I. *Concerning the Depth to plant at.*
- II. *The Quantity of Seed to plant.*
- III. *And the Distance of the Rows.*

{*a*} Vines, that cannot be ho'd by the Ploughs, are ho'd by the *Bidens*.

I. 'Tis

I. 'Tis necessary to know how deep we may plant our Seed, without Danger of burying it; for so 'tis said to be, when laid at a Depth below what 'tis able to come up at.

Different Sorts of Seeds come up at different Depths; some at six Inches, or more; some at not more than half an Inch: The Way to know for certain the Depth any Sort will come up at is, to make Gauges in this Manner: Saw off 12 Sticks of about 3 Inches Diameter: Bore a Hole in the End of each Stick, and drive into it a taper Peg; let the first Peg be half an Inch long, the next an Inch, and so on; every Peg to be half an Inch longer than the former, till the last Peg be six Inches long; then in that sort of Ground where you intend to plant, make a Row of Twenty Holes with the half-Inch Gauge; put therein Twenty good Seeds; cover them up, and stick the Gauge at the End of that Row; then do the like with all the other Eleven Gauges: This will determine the Depth, at which the most Seeds will come up (*a*).

When the Depth is known, wherein the Seed is sure to come up, we may easily discover, whether the Seed be good or not, by observing how many will fail: For in some Sorts of Seeds the Goodness cannot be known by the Eye; and there has been often great Loss by bad Seed, as well as by burying good Seed; both which Misfortunes might be prevented by this little Trouble; besides 'tis not convenient to plant some sorts of Seed at the utmost Depth they

(*a*) In the common way of Sowing 'tis hard to know the proper Depth, because some Seeds lying deep, and others shallow, it is not easy to discover the Depth of those that are buried: But I have found in drilling of black Oats, that when the Drill-Plough was set a little deeper for Trial, very few came up: Therefore 'tis proper for the Driller to use the Gauges for all Sorts of Seeds; for, if he drills them too deep, he may lose his Crop; or, if too shallow, in dry Weather, he may injure it, especially in Summer Seeds: but for those planted against Winter, there is the most Damage by planting too deep.

will come up at; for it may be so deep, as that the Wet may rot or chill the first Root, as in Wheat in moist Land.

The Nature of the Land, the Manner how it is laid, either flat, or in Ridges, and the Season of Planting, with the Experience of the Planter, acquired by such Trials, must determine the proper Depths for different Sorts of Seeds.

II. The proper Quantity of Seed to be drill'd on an Acre, is much less than must be sown in the common Way; not because Hoeing will not maintain as many Plants as the other; for, on the contrary, Experience shews it will, *cæteris paribus*, maintain more; but the Difference is upon many other Accounts: As that 'tis impossible to sow it so even by Hand, as the Drill will do; for let the Hand spread it never so exactly (which is difficult to do some Seeds, especially in windy Weather), yet the Unevenness of the Ground will alter the Situation of the Seed; the greatest Part rebounding into the Holes, and lowest Places; or else the Harrows, in Covering, draw it down thither; and tho' these low Places may have Ten Times too much, the high Places may have little or none of it: This Inequality lessens, in Effect, the Quantity of the Seed; because Fifty Seeds, in Room of One, will not produce so much as One will do; and where they are too thick, they cannot be well nourished, their Roots not spreading to near their natural Extent, for Want of Hoeing to open the Earth. Some Seed is buried (by which is meant the laying them so deep, that they are never able to come up, as *Columella* cautions, *Ut absque ulla Resurrectionis Spe sepeliantur*): Some lies naked above the Ground; which, with more uncovered by the first Rain, feeds the Birds and Vermin.

Farmers know not the Depth that is enough to bury their Seed, neither do they make much Difference in the Quantity they sow on a rough, or a
fine

fine Acre; tho' the same that is too little for the one, is too much for the other; tis all mere Chance-work, and they put their whole Trust in good Ground, and much Dung, to cover their Errors.

The greatest Quantity of Seed I ever heard of to be usually sown, is in *Wiltshire*, where I am informed by the Owners themselves, that on some Sorts of Land they sow Eight Bushels of Barley to an Acre; so that if it produce four Quarters to an Acre, there are but four Grains for one that is sown, and is a very poor Increase, tho' a good Crop; this is on Land plowed once, and then double-dung'd, the Seed only harrow'd into the stale and hard Ground (*a*), 'tis like not two Bushels of the eight will enter it to grow; and I have heard, that in a dry Summer an Acre of this scarce produces four Bushels at Harvest.

But, in Drilling, Seed lies all the same just Depth, none deeper, nor shallower, than the rest; here's no Danger of the Accidents of burying, or being uncover'd, and therefore no Allowance must be made for them; but Allowance must be made for other Accidents, where the Sort of Seed is liable to them; such as Grub, Fly, Worm, Frost, &c.

Next, when a Man unexperienc'd in this Method has proved the Goodness of his Seed, and Depth to plant at it, he ought to calculate what Number of Seeds a Bushel, or other Measure or Weight, contains: For one Bushel or one Pound of small Seed, may contain double the Number of Seeds, of a Bushel, or a Pound, of large Seed of the same Species.

This Calculation is made by weighing an Ounce, and counting the Number of Seeds therein; then weighing a Bushel of it, and multiplying the Number of Seeds of the Ounce, by the Number of Ounces

(*a*) Stale Ground is that which has lain some considerable time after Plowing, before it is sown, contrary to that which is sown immediately after plow'd; for this last is generally not so hard as the former,

of the Bushel's Weight; the Product will shew the Number of Seeds of a Bushel near enough: Then, by the Rule of Three, apportion them to the Square Feet of an Acre; or else it may be done, by dividing the Seeds of the Bushel by the Square Feet of an Acre; the Quotient will give the Number of Seeds for every Foot: Also consider how near you intend to plant the Rows, and whether Single, Double, Treble, or Quadruple; for the more Rows, the more Seed will be required (*a*).

Examine what is the Produce of one middle-fiz'd Plant of the Annual, but the Produce of the best and largest of the perennial Sort; because that by Hoeing will be brought to its utmost Perfection: Proportion the Seed of both to the reasonable Product; and, when 'tis worth while, adjust the Plants to their competent Number with the Hand-hoe, after they are up; and plant Perennials generally in single Rows: Lastly, Plant some Rows of the Annual thicker than others, which will soon give you Experience (better than any other Rule) to know the exact Quantity of Seed to drill.

III. The Distances of the Rows are one of the most material Points, wherein we shall find many apparent Objections against the Truth; of which, tho' full Experience be the most infallible Proof, yet the World is by false Notions so prejudiced against wide Spaces between Rows, that unless these common (and I wish I could say, only vulgar) Objections be first answer'd, perhaps no-body will venture so far out of the old Road, as is necessary to gain the Experience; without it be such as have seen it.

(*a*) The narrow Spaces (suppose seven Inches) betwixt Double, Treble, or Quadruple Rows, the Double having One, the Treble Two, and the Quadruple Three of them, are call'd *Partitions*.

The wide Space (suppose of near five Feet) betwixt any Two of these Double, Treble, or Quadruple Rows, is call'd an *Interval*.

I formerly was at much Pains, and at some Charge, in improving my Drills, for planting the Rows at very near Distances; and had brought them to such Perfection, that One Horse would draw a Drill with Eleven Shares, making the Rows at three Inches and half Distance from one another; and at the same Time sow in them Three very different Sorts of Seeds, which did not mix; and these too, at different Depths; as the Barley-Rows were seven Inches asunder, the Barley lay four Inches deep; a little more than three Inches above that, in the same Channels, was Clover; betwixt every Two of these Rows was a Row of St. Foin, cover'd half an Inch deep.

I had a good Crop of Barley the first Year; the next Year, Two Crops of Broad-Clover, where that was sown; and where Hop-Clover was sown, a mix'd Crop of That and St. Foin, and every Year afterwards a Crop of St. Foin; but I am since, by Experience, so fully convinced of the Folly of these, or any other such mix'd Crops, and more especially of narrow Spaces, that I have demolish'd these Instruments (in their full Perfection) as a vain Curiosity, the Drift and Use of them being contrary to the true Principles and Practice of Horse-Hoeing.

Altho' I am satisfied, that every one, who shall have seen as much of it as I have, will be of my Mind in this Matter; yet I am aware, that what I am going to advance, will seem shocking to them, before they have made Trials.

I lay it down as a Rule (to myself) that every Row of Vegetables, to be Horse-ho'd, ought to have an empty Space or Interval of thirty Inches on one Side of it (*a*) at least, and of near five Feet in all Sorts of Corn.

In

(*a*) Note, We call it one Row, tho' it be a Double, Treble, or Quadruple Row; because when they unite in the Spring, they seem to be all single; even the Quadruple then is but as one single Row. Observe

In Hand-hoeing there is always less Seed, fewer Plants, and a greater Crop, *cæteris paribus*, than in the common Sowing: Yet there, the Rows must be much nearer together, than in Horse-hoeing; because as the Hand moves many times less Earth than the Horse, the Roots will be sent out in like Proportion; and if the Spaces or Intervals, where the Hand-hoe only scratches a little of the upper Surface of them, should be wide, they would be so hard and stale underneath, that the Roots of perennial Plants would be long in running thro' them; and the Roots of many annual Plants would never be able to do it.

An Instance which shews something of the Difference between Hand-hoeing and Deep-hoeing is, That a certain poor Man is observ'd to have his Cabbages vastly bigger than any-body's else, tho' their Ground be richer, and better dung'd: His Neighbours were amaz'd at it, till the Secret at length came out, and was only this: As other People ho'd their Cab-

Observe, that as wide Intervals are necessary for perfect Horse-hoeing, so the largest Vegetables have generally the greatest Benefit by them; tho' small Plants may have considerable Benefit from much narrower Intervals than Five Feet.

The Intervals may be somewhat narrower for constant annual Crops of Barley, than of Wheat; because Barley does not shut out the Hoe-Plough so soon, nor require so much Room for Hoeing, nor so much Earth in the Intervals, it being a lesser Plant, and growing but about a Third-part of the Time on the Ground; but he that drills Barley, must resolve to reap it, and bind it up in Sheaves; for if he mows it, or does not bind it, a great Part will be lost among the Earth in the Intervals: But 'tis now found, that in a wet Harvest the best Way is not to bind up drill'd Barley or Oats; but instead thereof, to make up the Grips into little Heaps by Hands, laying the Ears upon one another inwards, and the Stubble-ones outwards; so that with a Fork that hath Two Fingers, and a Thumb, 'tis very easy to pitch such Heaps up the Waggon without scattering, or wasting any of the Corn.

'Tis also seen, that when the Reaper take Care to set their Grips with the But-ends in the Bottoms of the Intervals, and the Ears properly on the Stubble, they will so stand up from the Ground, as to escape much better from sprouting, than mow'd Corn.

bage with a Hand-hoe, he instead thereof dug his with a Spade: And nothing can more nearly equal (a) the Use of the Horse-hoe than the Spade does.

And when the Plants have never so much *Pabulum* near them, their fibrous Roots cannot reach it all, before the Earth naturally excludes them from it; for, to reach it all, they must fill all the Pores (b), which is impossible: So far otherwise it is, that we shall find it probable, that they can only reach the least Part of it, unless the Roots could remove themselves from Place to Place, to leave such Pores as they had exhausted, and apply themselves to such as were unexhausted; but they not being endow'd with Parts necessary for local Motion (as Animals are), the Hoe-Plough supplies their Want of Feet; and both conveys them to their Food, and their Food to them, as well as provides it for them; for by transplanting the Roots, it gives them Change of the Pasture, which it increases by the very Act of changing them from one Situation to another, if the Intervals be wide enough for this Hoeing Operation to be properly perform'd.

The Objections most likely to prepossess Peoples Minds, and prevent their making Trials of this Husbandry, are these:

First, they will be apt to think, that these wide, naked Spaces, not being cover'd by the Plants, will not be sufficient to make a good Crop.

For Answer, we must consider, that tho' Corn, standing irregular and *sparsem*, may seem to cover

(a) The Hoe-plough exceeds the Spade in this Respect, that it removes more of the Roots, and cuts off fewer; which is an Advantage when we till near to the Bodies of Plants that are grown large.

(b) The Roots of a Mint, set a whole Summer in a Glass, kept constantly replenished with Water, will, in Appearance, fill the whole Cavity of the Glass; but by compressing the Roots, or by observing how much Water the Glass will hold when the Roots are in it, we are convinc'd, that they do not fill a Fourth-part of its Cavity; tho' they are not stopp'd by Water, as they are by Earth.

the Ground better than when it stands regular in Rows; this Appearance (*a*) is a mere *Deceptio visus*; for Stalks are never so thick on any Part of the Ground as where many come out of one Plant, or as when they stand in a Row; and a ho'd Plant of Corn will have Twenty or Thirty Stalks (*b*), in the same Quantity of Ground where an unho'd Plant, being equally single, will have only Two or Three Stalks. These tillered ho'd Stalks, if they were planted *sparsum* all over the Interval, it might seem well cover'd, and perhaps thicker than the sown Crop commonly is; so that tho' these ho'd Rows seem to contain a less Crop, they may contain, in reality, a greater Crop than the sown, that seems to exceed it; and 'tis only the different Placing that makes one seem greater, and the other less, than it really is; and this is only when both Crops are young.

The next Objection is, That the Space or Interval not being *planted*, much of the Benefit of that Ground will be lost; and therefore the Crop must be less than if it were planted all over.

I answer, It might be so, if not Horse-ho'd; but if well Horse-ho'd, the Roots can run through the Intervals; and, having more Nourishment, make a greater Crop.

The too great Number of Plants, plac'd all over the Ground in common sowing, have, whilst it is open, an Opportunity of *wasting*, when they are very young, that Stock of Provision, for Want of which the greatest Part of them are afterwards starv'd; for

(*a*) For the Eye to make a Comparison betwixt a sown Crop and such a ho'd Crop, it ought, when 'tis half grown, to look on the ho'd Crop across the Rows; because in the other it does so, in Effect, which way soever it looks; but whatever Appearance the ho'd Crop of Vegetables (of as large a Species as Wheat) makes when young, it surely, if well managed, appears more beautiful at Harvest than a sown Crop.

(*b*) I have counted Fifty large Ears on one single ho'd Plant of Barley,

their irregular Standing prevents their being relieved with fresh Supplies from the Hoe: Hence it is, that the old Method exhausting the Earth to no Purpose, produces a less Crop; and yet leaves less *Pabulum* behind for a succeeding one, contrary to the Hoeing-Husbandry, wherein Plants are manag'd in all Respects by a quite different Oeconomy.

In a large Ground of Wheat it was prov'd, that the widest ho'd Intervals brought the greatest Crop of all: Dung without Hoeing did not equal Hoeing without Dung. And what was most remarkable, amongst Twelve Differences of wider and narrower Spaces, more and less ho'd, dung'd and undung'd, the Hand-sow'd was considerably the worst of all; tho' all the Winter and Beginning of the Spring, that made infinitely the most promising Appearance; but at Harvest yielded but about One-fifth Part of Wheat of that which was most hoed; there was some of the most hoed, which yielded Eighteen Ounces of clean Wheat in a Yard in Length of a double Row, the Intervals being thirty Inches, and the Partition Six Inches (*a*).

A Third Objection like the two former is, that so small a Part of the Ground, as that whereon the Row stands, cannot contain Plants or Stalks sufficient for a full Crop.

This some Authors endeavour to support by Arguments taken from the perpendicular Growth of Vegetables, and the Room they require to stand on; both which having answer'd elsewhere, I need not say much of them here; only I may add, that if Plants could be brought to as great Perfection, and so to

(*a*) The same Harvest, a Yard in Length of a double Row of Barley, having Six Inches Partition, produc'd Eight hundred and Eighty Ears in a Garden; but the Grains happen'd to be eaten by Poultry before 'twas ripe, so that their Produce of Grains could not be known: One like Yard of a ho'd Row of Wheat, in an undung'd Field, produc'd Four hundred Ears of Lammas-Wheat.

stand as thick all over the Land, as they do in the ho'd Rows, there might be produc'd, at once, many of the greatest Crops of Corn that ever grew.

But since Plants thrive, and make their Produce, in Proportion to the Nourishment they have within the Ground, not to the Room they have to stand upon it, one very narrow Row may contain more Plants than a wide Interval can nourish, and bring to their full Perfection, by all the Art that can be used; and 'tis impossible a Crop should be lost for want of room to stand above the Ground, tho' it were less than a Tenth-part of the Surface (*a*).

In wide Intervals there is another Advantage of Hoeing, I mean Horse-hoeing (the other being more like Scratching and Scraping than Hoeing): There is room for many Hoeings (*b*), which must not come
very

(*a*) Mr. Houghton calculates, that a Crop of Wheat of Thirty Quarters to an Acre, each Ear has two Inches and a Half of Surface; by which 'tis evident, that there would be Room for many such prodigious Crops to stand on.

And a Quick-hedge, standing between two Arable Grounds, one Foot broad at Bottom, and Eighteen Feet in Length, will, at fourteen Years Growth, produce more of the same Sort of Wood, than eighteen Feet square of a Coppice will produce in the same Time, the Soil of both being of equal Goodness.

This seems to be the same Case with our ho'd Rows; the Coppice, if it were to be cut in the first Years, would yield perhaps ten Times as much Wood, as the Hedge; but many of the Shoots of the Coppice constantly die every Year, for Want of sufficient Nourishment, until the Coppice is fit to be cut; and then its Product is much less than that of the Hedge, whose Pasture has not been over-stock'd to such a Degree as the Coppice-Pasture has been; and therefore brings its Crop of Wood to greater Perfection than the Coppice-Wood, which has Eighteen Times the Surface of Ground to stand on: The Hedge has the Benefit of Hoeing, as oft as the Land on either Side of it is till'd; but the Coppice, like the sown Corn, wants that Benefit.

(*b*) Many Hoeings; but if it should be asked how many, we may take Columella's Rule in hoeing the Vines, viz. *Numerus autem vertendi Seli (bidentibus) definitus non est, cum quanto cre-*
V 2 *bric*

very near the Bodies of some annual Plants, except whilst they are young; but in narrow Intervals, this cannot be avoided at every Hoeing: 'Tis true, that in the last Hoeings, even in the middle of a large Interval, many of the Roots may be broken off by the Hoe-plough, at some considerable Distance from the Bodies; but yet this is no Damage, for they send out a greater Number of Roots than before; as in Chap. I. appears.

In wide Intervals, those Roots are broken off only where they are small; for tho' they are capable of running out to more than the Length of the external Parts of a Plant; yet 'tis not necessary they should always do so; if they can have sufficient Food nearer to the Bodies (*a*) of the Plants.

And these new, young, multiply'd Roots are fuller of Lacteal Mouths than the older ones; which makes it no Wonder, that Plants should thrive faster by having some of their Roots broken off by the Hoe; for as Roots do not enter every Pore of the Earth, but miss great Part of the Pasture, which is left unexhausted, so when new Roots strike out from the broken Parts of the old, they meet with that Pasture, which their Predecessors miss'd, besides that new Pasture which the Hoe raises for them; and those Roots which the Hoe pulls out without breaking,

brior sit, plus produsse passionem conveniat. Sed imperfurum Ratio modum prescribit. Lib. 4. Cap. 5.

Neither is it altogether the Number of Hoeings that determines the Degrees of Pulveration: For, Once well done, is Twice done; and the oftener the better, if the Expence be not excessive.

Poor Land, be it never so light, should have the most Hoeings; because Plants, receiving but very little Nourishment from the natural Pasture of such Land, require the more artificial Pasture to subsist on.

(*a*) All the Mould is never so near to the Bodies of Plants, as 'tis when the Row stands on a high Six-foot Ridge, when the middle of the Interval is left bare of Earth, at the last Hoeing; for then all the Mould may be but about a Foot, or a foot and half, distant from the Body of each Plant of a Treble Row.

and

and covers again, are turn'd into a fresh Pasture; some broken, and some unbroken: All together invigorate the Plants.

Besides, the Plants of sown Corn, being treble in Number to those of the drill'd, and of equal Strength and Bulk, whilst they are very young, must exhaust the Earth whilst it is open, thrice as much as the drill'd Plants do; and before the sown Plants grow large, the Pores of the Earth are shut against them, and against the Benefit of the Atmosphere; but for the drill'd, the Hoe gives constant Admission to that Benefit; and if the Hoe procures them (by dividing the Earth) Four Times the Pasture of the sown during their Lives, and the Roots devour but one half of that, then tho' the ho'd Crop should be double to the sown, yet it might leave twice as much *Pabulum* for a succeeding Crop. 'Tis impossible to bring these Calculations to Mathematical Rules; but this is certain in Practice, that a sown Crop, succeeding a large undung'd ho'd Crop, is much better than a sown Crop, that succeeds a small dung'd sown Crop. And I have the Experience of poor, worn out Heath-ground, that, having produc'd Four successive good ho'd Crops of Potatoes (the last still best), is become tolerable good Ground.

In a very poor Field were planted Potatoes, and, in the very worst Part of it, several Lands had them in Squares a Yard asunder; these were plowed four ways at different times: Some other Lands adjoining to them, of the very same Ground, were very well dung'd and till'd; but the Potatoes came irregularly, in some Places thicker, and in others thinner: These were not ho'd, and yet, at first coming up, looked blacker and stronger than those in Squares not dung'd, either that Year, or ever, that I know of; yet these Lands brought a good Crop of the largest Potatoes, and very few small ones amongst them; but in the dung'd Lands, for Want of Hoeing, the Potatoes

were not worth the taking up; which proves, that in those Plants that are planted so as to leave Spaces wide enough for Repetitions of Hoeing, that Instrument can raise more Nourishment to them, than a good Coat of Dung with common Tillage.

Another Thing I have more particularly observ'd, *viz.* That the more successive Crops are planted in wide Intervals, and often ho'd, the better the Ground does maintain them; the last Crop is still the best, without Dung, or changing the Sort of Plant; and this is visible in Parts of the same Field, where some Part has a first, some other Part a second, the rest a third Crop growing all together at the same time; which seems to prove, that as the Earth is made by this Operation to dispense or distribute her Wealth to Plants, in Proportion to the Increase of her inner Superficies (which is the Pasture of Plants); so the Atmosphere, by the Riches in Rain and Dews, does annually reimburse her in Proportion to the same Superficies, with an Overplus for Interest: But if that Superficies be not increased to a competent Degree, and, by frequent Repetitions of Hoeing, kept increasing (which never happens in common Husbandry) this Advantage is lost; and, without often repeated Stercoration, every Year's Crop grows worse; and it has been made evident by Trials, which admit of no Dispute, that Hoeing, without Dung or Fallow, can make such Plants as stand in wide Intervals, more vigorous in the same Ground, than both common Dugging and Fallowing can do without Hoeing.

This Sort of Hoeing has in Truth every Year the Effect of a Summer-fallow; tho' it yearly produce a good Crop.

This is one Reason of the different Effects Plants have upon the Soil; some are said to enrich it, others to burn it, *i. e.* to impoverish it; but I think it may be observed, that all those Plants, which are usually ho'd, are reckoned among the Enrichers;
and

and tho' it be certain that some Species of Plants are, by the Heat of their Constitution, greater Devourers than those of another Species of equal Bulk; yet there is Reason to believe, that were the most cormorant Plant of them all to be commonly ho'd, it would gain (*a*) the Reputation of an Enricher or

(*a*) But this must be intended of the deep Horse hoeing; for Turneps that stand for Seed, are such Devourers, and feed so long on the Soil, that tho' they are Hand-ho'd, such a shallow Operation doth not supply the usual Thickness of those Plants with Pasture sufficient to raise their Stems to half their natural Bulk; and they leave so little of that Pasture behind them, that the Soil is observ'd to be extremely impoverished for a Year or two, and sometimes three Years after them; but 'tis otherwise with my Horse-ho'd Turnep-Seed; for I never fail'd of a good Crop of Barley after it, sown on the Level in the following Spring, tho' no Dung hath been used on the Land where the Turnep-Seed grew for many Years. And also my Barley Crops thus sown after two successive Crops of Turnep-Seed without a Fallow between them, are as good as those sown after a single Crop of it. For I have several Times made these Turnep-Seed Crops annual, that is. to have Two Crops of it in Two Years, which would in the old Way require three Years, because this Crop stands about a Year on the Ground, and is not ripe till Midsummer, which is too late to get that Land into a Tilth proper to plant another Seed Crop on it the same Summer; neither can the Soil be able to bear such another Crop immediately after being so much exhausted, and unplowed for a whole Year, except it be extraordinary rich, or much danged: However, Two Crops of Turnep-Seed immediately succeeding one another, is what I never knew, or heard of, except my own that were Horse-ho'd; and of these the second Crop was as good as the first; their Stalks grew much higher than they usually do in the common Way; and tho' the Number of Plants was much less, their Produce was so valuable, that the *Vicar's Agent* declared, he made Twenty Shillings per Acre of his Tythe of a whole Field which he tythed in Kind. The Expence of these Crops was judg'd to be answered by the Fuel of the thresh'd Stalks. It must be noted, that the extraordinary Value of these Crops arose, not from a greater Quantity of Seed than some common Crops; but from their Quality, Experience having brought this Seed into great Esteem, on account of its being perfectly clean, and produced by large Turneps of a good Sort, and of a proper Shape; for those that are not well cultivated are very apt to degenerate, and then their Seed will produce Turneps of a small Size, and of a long rasy ill Shape.

Improver of the Soil; except it should be such, as might occasion Trouble, by filling it full of its shatter'd Seeds, which might do the Injury of Weeds to the next Crop; and except such Plants, which have a vast Bulk to be maintained a long Time, as Turnep-Seed (*a*).

The wider the Intervals are, the more Earth may be divided; for the Row takes up the same Room with a wide, or a narrow Interval; and therefore with the wide, the unho'd Part bears a less Proportion to the ho'd Part than in the narrow.

And 'tis no Purpose to hoe, where there is not Earth to be ho'd, or Room to hoe it in.

There are many Ways of Hoeing with the Hoe-Plough; but there is not Room to turn Two deep clean Furrows in an Interval that is narrower than Four Feet Eight Inches; for if it want much of this Breadth, one, at least, of these Furrows, will reach, and fall upon the next Row, which will be very injurious to the Plants; except of grown St. Foin, and such other Plants, that can bear to have the Earth pull'd off them by Harrows.

Thus much of Hoeing in general may suffice: And different Sorts of Plants requiring different Management; that may more properly be described in the Chapter, where particular Vegetables are treated of.

It may not be amiss to add, that all Sorts of Land are not equally proper for Hoeing: I take it, that a dry friable Soil is the best. Intractable wet Clays, and such Hills as are too steep for Cattle to draw a Plough up and down them, are the most improper (*b*).

(*a*) Turneps run to Seed, not till the second Summer.

(*b*) For by hoeing cross the Hill, the Furrow turn'd against the Declivity cannot be thrown up near enough to the Row above it; and the Furrow that is turn'd downwards will bury the Row below it.

That 'tis not so beneficial to hoe in Common-fields, is not in Respect of the Soil, but to the old Principles, which have bound the Owners to unreasonable Customs of changing the Species of Corn, and make it necessary to fallow every Second, Third, or Fourth Year at farthest.

C H A P. VII.

Of WEEDS.

PLANTS, that come up in any Land, of a different Kind from the sown or planted Crop, are Weeds.

That there are in Nature any such things as *inutiles Herbæ*, the Botanists deny; and justly too, according to their Meaning.

But the Farmer, who expects to make Profit of his Land from what he sows or plants in it, finds not only *Herbæ inutiles*, but also *noxia*, unprofitable and hurtful Weeds; which come like *Muscæ*, or uninvited Guests, that always hurt, and often spoil his Crop, by devouring what he has, by his Labour in Dunging and Tilling, provided for its Sustenance.

All Weeds, as such, are pernicious; but some much more than others; some do more Injury, and are more easily destroy'd; some do less Injury, and are harder to kill; others there are, which have both these bad Qualities. The hardest to kill are such as will grow and propagate by their Seed, and also by every Piece of their Roots, as Couch-grass, Coltsfoot, Melilot, Fern, and such-like. Some are hurtful only by robbing legitimate (or sown) Plants of their Nourishment, as all Weeds do; others both lessen a legitimate Crop by robbing it, and also spoil that Crop, which escapes their Rapine, when they infect it

it with their nauseous Scent and Relish, as Melilot, wild Garlick, &c.

Weeds starve the sown Plants, by robbing them of their Provision of Food (*a*), not of their Room (as some Authors vainly imagine); which will appear by the following Experiment.

Let three Beds of the same Soil, equal, and equally prepared, be sown with the same Sort of Corn. Let the first of these Beds be kept clean from Weeds: In the Second, let a Quantity of Weeds grow along with the Corn; and in the Third, stick up a Quantity of dead Sticks, greater in Bulk than the Weeds.

It will be found, that the Produce of the Corn in the First will not exceed that of the Third Bed; but in the Second, where the Weeds are, the Corn will be diminish'd in Proportion to the Quantity of Weeds amongst it.

The Sticks, having done no Injury to the Corn, shew there was room enough in the Bed for Company to lodge, would they forbear to eat; or else (like Travellers in *Spain*) bring their Provision with them to their Inn, or (which would be the same thing) if Weeds could find there some Dish so disagreeable to the Palate of the Corn, and agreeable to their own, that they might feed on it without robbing; and then they would be as innocent as the Sticks, which take up the same Room with the Weeds.

The Quantity of Nourishment Weeds rob the Corn of, is not in Proportion only to their Number and Bulk, but to the Degrees of Heat in their Con-

(*a*) A Tree of any Sort will spoil Corn all round it, in a large Circle; half an Acre of Turneps has been spoil'd by one: Hereby 'tis plain, that Trees rob as Weeds; because 'tis not by their Shadow, there being as much Damage done by them on the South-Side, where their Shadow never comes, as on their North-Side: Nor can it be by their dropping; for 'tis the same on the Side where a Tree has no Boughs to drop over the Plants, when they are also at a very great Distance from all Parts of the Tree, except its Roots.

stitution; as appears by the Instance of Charlock and Turneps, mention'd in the Chapter *Of Change of Species*.

'Tis needless to go about to compute the Value of the Damage Weeds do, since all experienc'd Husbandmen know it to be very great, and would unanimously agree to extirpate their whole Race as intirely, as in *England* they have done the Wolves, tho' much more innocent, and less rapacious than Weeds (*a*).

But alas! they find it impossible to be done, or even to be hoped for, by the common Husbandry; and the Reasons I take to be these.

The Seeds of most Sorts of Weeds are so hardy, as to lie sound and uncorrupt for many Years (*b*), or perhaps Ages in the Earth; and are not kill'd until they begin to grow or sprout, which very few of them do, unless the Land be plow'd; and then enough of them will ripen amongst the sown Crop, to propagate and continue their Species, by shedding their Off-spring in the Ground (for 'tis observ'd they are generally ripe before the Corn); and the Seeds of these do the same in the next sown Crop; and thus perpetuate their savage, wicked (*c*) Brood, from Generation to Generation.

Besides, their Seeds never all come up in one Year, unless the Land be very often plow'd; for they must have their exact Depth, and Degrees of Moisture and

(*a*) If we consider the Crops they utterly destroy, and those they extremely diminish; and that very few Crops escape without receiving Injury from them; it may be a Question, whether the Mischief Weeds do to our Corn, is not as great as the Value of the Rent of all the Arable Lands in *England*.

(*b*) The Seeds of *Lethan Poppy* (call'd *Red-weed*) have lain dormant 24 Years (the Land being, during that time, in *St. Foin*) and then at first Plowing they came up very thick; this I have seen, and so will many other Sorts of Weeds, when the Ground has lain untill'd for an Age.

(*c*) The *French* call them, *les Herbes Sauvages, & les mechantes Herbes*.

Heat, to make them grow; and such as have not these, will lie in the Ground, and retain their vegetative Virtue for Ages; and the common usual Plowings, not being sufficient to make them all, or the greatest Part, grow, almost every Crop that ripens increases the Stock of Seed, until it make a considerable Part of the Staple of such Land as is sown without good Tillage and Fallowing.

The best Defence against these Enemies, which the Farmer has hitherto found, is to endeavour their Destruction by a good Summer-fallow: This indeed, if the Weather be propitious, does make Havock of them; but still some will escape one Year's Prosecution. Either by being sometimes situate so high, that the Sun's Heat dries them, or sometimes lying so deep, that it cannot reach them; either way their Germination, which would have proved their Death, is prevented.

Another Faculty secures abundance of them, and that is, their being able to endure the Heat and Moisture of one Year without growing; as (*a*) wild Oats, and innumerable other Sorts of Weeds, will do; for gather these when ripe, sow them in the richest Bed, water them, and do all that is possible to make them grow the First Year, it will be vain Labour; they will resist all Enticements till the Second; that is, if you gather them in Autumn, you cannot force them to grow until the next Spring come Twelve-month; and many of them will remain dormant even to the next Year after that, and some of them longer.

By this Means, One Year's Summer-Fallow can have no Effect upon them, but to prepare the Soil

(*a*) I have not try'd wild Oats by sowing them in a Bed myself, but have been so inform'd by others; and my own Experience hath frequently shewn me, that they will come up, after lying many Years in the Ground; and that very few Sorts of Weeds will come all up the first Year, as Corn doth: If they did, the Tillage of one Year's Summer-fallow might extirpate them.

for their more vigorous Growth and plentiful Increase the next Year after; and very rarely will the Farmer fallow his Land Two Years successively; and often the Dung, which is made of the Straw of sown Corn, being full of the Seeds of Weeds, when spread on the Fallows, incumbers the Soil with another Stock of Weeds, as ample as that the Fallowing has destroy'd; and tho' perhaps many of these may not grow the next Year, they will be sure to come up afterwards.

The other old Remedy is what often proves worse than the Disease; that is, what they call Weeding among sown Corn; for if by the Hook or Hand they cut some Sorts (as Thistles) while they are young, they will sprout up again, like *Hydras*, with more Heads than before; and if they are cut when full-grown, after they have done almost their utmost in robbing the Crop, 'tis like shutting the Stable-Door after the Steed is stolen.

Hand-weeders often do more Harm to the Corn with their Feet, than they do Good by cutting or pulling out the Weeds with their Hands; and yet I have known this Operation sometimes cost the Farmer Twelve Shillings an Acre; besides the Damage done by treading down his Wheat; and, after all, a sufficient Quantity of them have escaped, to make a too plentiful Increase in the next Crop of Corn.

The new Hoeing-Husbandry in Time will probably make such an utter Riddance (*a*) of all Sorts of Weeds (*b*), except such as come in the Air, that

(*a*) A very pernicious, large, perennial Weed, like *Burrage*, with a blue Flower, infested a Piece of Land, for Time out of Mind: Hoeing has destroyed it utterly; not one of the Species has been seen in the Field these Seven Years, tho' constantly till'd and ho'd.

(*b*) I have now a Piece of Wheat drill'd early the last Autumn upon an Hill, fallowed and well pulveriz'd: Part of it was drill'd with Wheat in double Rows upon the Level Nine Years ago,

that (c) as long as this Management is properly continued, there is no Danger to be apprehended from them; which is enough to confute the old Error

Horſe-ho'd, and the Partitions thoroughly Hand-ho'd to cleanſe out the Poppies, of which the Land was very full; the other Part of this Piece was never drilled till this Year: The whole Piece hath not been before this Winter Horſe-ho'd. Now the Partitions of the Part that was never any Way Ho'd, are ſo ſtock'd with Poppies matted together, that unleſs they are taken out early in the Spring, they will totally devour the Rows of Wheat; but in the other Part that was ho'd ſo long ſince, there are now very few Poppies to be ſeen. Both theſe Parts have had ſeveral fown Crops of Barley together ſince, and have lain with *St. Foin* theſe laſt Five or Six Years.

(c) And except alſo ſuch Weeds, whoſe Seed is carried by Birds, which is the moſt common Manner of transporting the Seeds of Vegetables from Field to Field, againſt the Content of the Owner: For Birds, whether great or ſmall, do not care to eat their Prey where they take it, but generally cauſe ſome open Place for that Purpoſe. 'Tis, I am perſuaded, by this Means chiefly, that a Vineyard or Field, made ever ſo clean from Graſs, will, in lying untill'd a few Years, be replenish'd with a Turf of that neighbouring Species of Graſs, which beſt ſuits the Heat and Moiſture of the Soil: Yet there are ſome Species of Seeds that Birds (at leaſt ſuch as frequent this Place) do not affect; elſe the Burrage-weed (mentioned in p. 77.) would have appeared again in my Field in ſome of the many Years ſince the Hoing has extirpated it there; for it grows plentifully in the unplow'd Way adjoining thereto.

The Seeds of ſome Weeds may be ſuſpected to come in the Air; as the Seed of the Graſs that grew in the *Cherapſide*, in the Time of the Plague; but it might come from Seeds in the Dirt, brought thither by the Feet of People and Cattle, and by the Wheels of Coaches, Cars carrying Hay: Or otherwiſe continual Treading might keep it from Growing; and when the Treading ceaſed, 'tis no Wonder the Seeds ſhould furniſh the Streets with Graſs.

And I have obſerv'd on the Floors, two Stories high, of a lone, ruinous, uninhabited Houſe, being long uncover'd, a ſort of Herb growing very thick; I think it was *Pimpernel*, and believe that its Seeds did not come thither in the Air; but in the Sand which was mix'd with the Mortar that had fallen from the Cielings; and 'tis like there were few Seeds at firſt: Yet, theſe, ripening for ſeveral Years, thed their Seeds annually, until the Floors became all over very thick planted: Beſides, Hay-ſeeds and Pimpernel are too heavy to be carry'd far by the Air.

of equivocal Generation, had it not been already sufficiently exploded, ever since that Demonstration of *Malpighius's* Experiment. For if Weeds were brought forth without their proper Seeds, the Hoeing could not hinder their Production, where the Soil was inclined naturally to produce them. The Belief of that blind Doctrine might probably be one of the Causes that made the Antients despair of finding so great Success in Hoeing, as now appears; or else, if they had had true Principles, they might perhaps have invented and improved that Husbandry, and the Instruments necessary to put it in Practice.

C H A P. VIII.

Of TURNEPS.

AS far as I can be inform'd, 'tis but of late Years that Turneps have been introduc'd as an Improvement in the Field.

All Sorts of Land, when made fine by Tillage, or by Manure and Tillage, will serve to produce Turneps, but not equally; for chalky Land is generally too dry (a Turnep being a thirsty Plant); and they are so long in such dry poor Land before they get into rough Leaf, that the Fly is very apt to destroy them there; yet I have known them succeed on such Land, tho' rarely.

Sand and Gravel are the most proper Soil for Turneps, because that is most easily pulveriz'd, and its Warmth causeth the Turneps to grow faster, and so they get the sooner out of the Danger of the Fly; and such a Soil, when well-till'd, and Horse-ho'd, never wants a sufficient Moisture, even in the driest Weather; and the Turneps being drill'd will come up without Rain, and prosper very well with the sole
Moisture

Moisture of the Dews, which are admitted as deep as the Pulveration reacheth; and if that be to Five or six Inches, the hottest Sun cannot exhale the Dews thence in the Climate of *England*: I have known Turneps thrive well in a very dry Summer by repeated Horse-hoeings, both in Sand and in Land which is neither sandy nor gravelly.

When I sow'd Turneps by Hand, and ho'd them with a Hand-hoe, the Expence was great, and the Operation not half perform'd, by the Deceitfulness of the Hoers, who left half the Land unho'd, and cover'd it with the Earth from the Part they did hoe, and then the Grass and Weeds grew the faster: Besides, in this Manner a great Quantity of Land could not be managed in the proper Season.

When I drill'd upon the Level (*a*), at Three Feet Intervals, a Trial was made between those Turneps and a Field of the next Neighbour's, sown at the same Time, whereof the Hand-hoeing cost Ten Shillings *per* Acre, and had not quite half the Crop of the drill'd, both being measur'd by the Bushel, on Purpose to find the Difference (*b*).

In the new Method they are more certain to come up quickly; because in every Row, half the Seed is planted about Four Inches deep (*c*); and the other Half is planted exactly over that, at the Depth of half an Inch, falling in after the Earth has cover'd

(*a*) 'Tis impossible to hoe-plow them so well when planted upon the Level, as when they are planted upon Ridges; for if we plow deep near the Row, the Earth will come over on the Left-Side of the Plough, and bury the younger Turneps; but when they stand on Ridges, the Earth will almost all fall down on the Right Side into the Furrow in the Middle of the Interval.

(*b*) And I have since found, that Turneps on the same Land, planted on Ridges, with Six-foot Intervals, make a Crop double to those that are planted on the Level, or even on Ridges with Three-foot Intervals.

(*c*) Turnep-seed will come up from a greater Depth than most other Sorts of Seeds.

the first Half: Thus planted, let the Weather be never so dry, the deepest Seed will come up; but if it raineth (immediately after planting), the Shallow will come up first: We also make it come up at Four (*d*) Times, by mixing our Seed, half new and half old (the new coming up a Day quicker than the old): These four Comings up give it so many Chances for escaping the Fly, it being often seen, that the Seed sown over Night will be destroy'd by the Fly, when that sown the next Morning will escape, and *vice versa* (*e*); or you may hoe-plow them, when you the Fly is like to devour them; this will bury the greatest Part of those Enemies; or else you may drill in another Row, without new-plowing the Land.

This Method has also another Advantage of escaping the Fly, the most certain of any other, and infallible, if the Land be made fine, as it ought to be: This is to roll it with a heavy Roller across the Ridges, after 'tis drill'd, which closing up the Cavities of the Earth, prevents the Fly's Entrance and Exit, to lay the Eggs, hatch, or bring forth the young ones to prey upon the Turneps; which they might intirely devour, if the Fly came before they had more than the first two Leaves, which, being form'd of the very Seed itself, are very sweet; but the next Leaves are rough and bitter, which the Fly does not love: I have always found the Rolling disappoint the Fly; but very often it disappoints the Owner also, who sows at Random; for it makes the Ground so hard, that the Turneps cannot thrive, but look yellow, dwindle, and grow to no Perfection, unless they have a good Hoeing soon after the rough Leaves appear; for

(*d*) I have seen drill'd Turnep-feed come up daily for a Fortnight together, when it has not been mixt thus, the old with the new.

(*e*) I have had the first Turneps that came up all destroy'd by the Fly; and about a Fortnight afterwards more have come up, and been ho'd time enough, and made a good Crop.

when they stand long without it, they will be so poor and stunted, that the Hand-hoe does not go deep enough to recover them; and 'tis seldom that these rolled Turneps can be Hand-ho'd at the critical Time, because the Earth is then become so hard, that the Hoe cannot enter it without great Difficulty, unless it be very moist; and very often the Rain does not come to soak it, until it be too late; but the drill'd Turneps being in single Rows with Six-foot Intervals, may be roll'd without Danger: For be the Ground ever so hard, the Hand-hoe will easily single them out, at the Price of Six-pence per Acre, or less (if not in Harvest); and the Horse-hoe will, in those wide Intervals, plow at any Time, wet or dry; and, tho' the Turneps should have been neglected till stunted, will go deep enough to recover them to a flourishing Condition.

Drill'd Turneps, by being no-where but in the Rows (*f*), may be more easily seen than those which come up at Random; and may therefore be sooner (*g*)

(*f*) Drill'd Turneps coming all up nearly in a *Mathematical Line*, 'tis very nearly that a Charlock, or other like Weed, comes up in the same Line amongst them, unless it be drill'd in with the Turnep-seed, of which Weeds our Horse-ho'd Seed never has any; there being no Charlock in the Rows, nor any Turnep in the Intervals: We know, that whatever comes up in the Interval is not a Turnep, though so like to it, that, at first coming up, if promiscuously, it cannot easily be distinguished by the Eye, until after the Turneps, &c. attain the rough Leaf; and even then, before they are of a considerable Bigness, they are so hard to be distinguished by those People, who are not well experienced, that a Company of *Hand-boers* cut out the Turneps by Mistake, and left the Charlock for a Crop of a large Field of sown Turneps. Such a Misfortune can never happen to drill'd Turneps, unless wilfully done, be they set out ever so young.

(*g*) The sooner they are made single, the better; but yet, when they are not very thick, they may stand till we have the best Convenience of singling them without much Damage; but, when they come up extraordinary thick, 'twill be much more difficult to make them single, if they are neglected at their very first coming into rough Leaf.

singled

single'd out by the Hand-hoe; which is another Advantage; because the sooner they are so set out, the better they will thrive (*b*).

Three or Four Ounces of Seed is the usual Quantity to drill; but, at random, Three or Four Pounds are commonly sown, which, coming thick all over the Ground, must exhaust the Land more than the other, especially since the sown must stand longer, before the Hoers can see to set them out.

The Six-foot Ridges, whereon Turneps are drill'd in single Rows, may be left higher than for double-row'd Crops; because there will be more Earth in the Intervals, as the single Row takes up less.

There is no prefix'd Time for planting Turneps, because that must be according to the Richness of the Land; for some Land will bring them as forward, and make them as good, when planted the beginning of *August*, as other Land will, when planted in *May*; but the most general Time is, a little before, and a little after *Midsummer*.

Between these Rows of Turneps (*i*), I have planted Wheat in this Manner; *viz.* About *Michaelmas*, the
Turneps

(*b*) Because such young Turneps will enjoy the more of the Pasture made by the Plowing, and by that little Pulveration of the Hand-hoe, without being robb'd of any Pasture by their own supernumerary Plants.

(*i*) As I have formerly drilled Wheat between Rows of Turneps, so I have since had the Experience of drilling Turneps between Rows of Barley and Rows of Oats: I have had them in the Intervals between Six-foot Ridges, and between Four-foot Ridges, and between those of several intermediate Distances; but which of them all is the best, I leave at present undetermined. I shall only add, that the poorer the Land is, the wider the Intervals ought to be; and that, in the narrow, 'tis convenient at the Hoeing, to leave more Earth on that Side of each Interval whereon the Turneps are to be drill'd; and this is done by going round several Intervals with the Hoe-Plough, without going forwards and backwards in each immediately: But in the wide Intervals the Earth may be equal on both Sides of them.

Turneps being full grown, I plow'd a Ridge in the Middle of each of their Intervals, taking most of the Earth

I will propose another Method of Drilling, which may be very advantageous to those who sow their Barley upon the Level, and sow Turnep-seed amongst it, at Random, as they do Clover; which is, of late, a common Practice in some Places. The Barley keeps the Turneps under it, and flints them so much, that they are useful in the Winter or Spring, chiefly by the Food their *Leaves* afford to Sheep, their Roots being exceeding small; and for this small Profit they lose the Time of tilling the Ground, until after the Turneps are eaten off; which is a Damage we think greater than the Profit of such Turneps: To prevent which Damage, they may drill them in Rows at competent Distances, and Horse-hoe them, and set them out as soon as the Barley is off: This will both keep the Ground in Tilth, fit for another Crop of Spring Corn, and cause the Turneps to grow great enough (especially if Harvest be early, and the Winter prove favourable) for feeding of Sheep in a moveable Fold to dung the Ground into the Bargain.

What induces me to propose this Improvement is, that a Gentleman plows up his Barley-Stubble, and transplants Turneps therein, and Hand-hoes them with Success. By the proposed Way all the Expence of transplanting (which must be considerable) will be saved; and the setting out cannot be more than an Eighth of the Labour of *Hand boings*; and I conjecture the Horse-hoed Turneps may be as good; for they (though flinted) having their Tap-roots remaining unmoved below the Staple of the Land, their horizontal Roots, being supply'd with Moisture from the Tap-roots, immediately take hold of the fresh-plow'd Earth, as soon as 'tis turned back to them; whereas the transplanted, having their Tap-roots broken off, and their Horizontal Roots crumpled in the Holes wherein they are set, must lose Time, and be in Danger of dying with Thirst, if the Weather proves dry.

Also this Way seems better than the common Practice of sowing Turneps upon once plowing after Wheat; because the Wheat-land commonly lies longer unplow'd by Six or Eight Months than Barley-land; and therefore cannot be in so good Tilth for Turneps as Barley-land may, unless the former be of a more friable Nature, or much more dunged, than the latter. Besides, these Wheat-Turneps are uncertain, in Respect of the Fly that often destroys them at their first coming up; which Misfortune happened the Autumn 1734. to almost all that were sown in that Manner.

I have observ'd, that Barley sown on the Level, and not hoed, overcomes the Turneps that come up amongst it; but that Turneps

Earth from the Turneps, leaving only just enough to keep them alive; and on this Ridge drill'd my Crop of Wheat (*k*), and towards the Spring pull'd up my Turneps, and carried them off for Cattle.

When Turneps are planted too late, to have Time and Sun for attaining to their full Bulk, some drill a double Row on each Six-foot Ridge, with a Partition of Fourteen Inches; but I am told, that in this double Row the Turneps do not, even at that late Season, grow so large, as those planted at the same time in single Rows; tho' the double Row requires

neps, which come up in the Partitions of Treble Rows of my Ridges of Horse-hoed Barley, grew so vigorously as to overcome the Barley. And this was demonstrated at Harvest in a long Field, one Side of which had borne Turnep seed, and the drilled Ridges of Barley crossing the Middle of it; and both Ends of the Field having Barley sown on the Level, one End of every Ridge cross'd the Turnep-feed Part of the Field for about Ten Perches of their Length.

I observed also, that the Turneps near the Edges of the Lands of sown Barley, adjoining to the hoed Intervals, grew large, but not so large as those in the Partitions on the Ridges, their Intervals being hoed on each Side of them.

But different from this have I seen shattered Turnep-feed coming up in the like Partitions of drilled Wheat, on the very same Sort of Land, so miserably poor and stunted, that they scarce grew a Hand's Breadth high, when those Turneps which the Hoe left in the Sides of the Intervals, and at the narrow Edges of the unhoed Earth of the Interval Sides of the Rows of Wheat, grew large; and the Wheat was good also: But I do not remember how the middle Row of it succeeded.

This last Experience of the Turneps among the Wheat was got by this Accident: The Wheat was drilled after drilled Turneps on Ridges of a different Size. The Turneps were all pulled up before the Ground was plowed for the Wheat; but as Turnep-feed never comes *all* up the first Year, enough remained of this to come up (though thinly) in the Wheat, to shew exactly where every Row had been drilled; whereupon the Observation was made.

(*k*) This Wheat, being thus drill'd on the new Ridges made in the Intervals, betwixt the Rows of Turneps, being well Horse-ho'd in the Spring, prov'd a very good Crop; it was drill'd in treble Rows, the Partitions Seven Inches each.

double the Expence in setting out; and there will be less Earth ho'd by the Breadth of fourteen Inches of the deepest Part of the Ridge, and consequently the Land will be the less improv'd for the next Crop. We need not to be very exact, in the Number (*l*) or Distance (*m*) we set them out at; we contrive to leave the Master-turneps (when there is much Difference in them), and spare such when near one another, and leave the more Space before and behind them; but if they be Three Master-turneps too near together, we take out the middlemost.

Turneps that were so thick as to touch one another when half-grown, by means of well Hoeing their wide Intervals, have afterwards grown to a good Bigness, and by thrusting against one another became oval, instead of round.

'Tis beneficial to hoe Turneps (especially the first Time) alternately; *viz.* to hoe every other Interval, and throw the Earth back again before we hoe the other Intervals; for by this Means the Turneps are kept from being (*n*) stinted: 'Tis better to have Nourishment given them moderately at twice, than to have it all once, and be twice as long before a Repetition (*o*).

(*l*) The least Number will be the largest Turneps; yet we should have a competent Stock, which I think is not less than Thirty on a square Perch.

(*m*) The Distance need not to be regular; for when a Turnep has Six Inches of Room on one Side, and Eighteen Inches on the other Side, 'tis almost as well as if there was one Foot on each Side: tho' then it would be equally distant from the Two Turneps betwixt which it stood.

(*n*) Because this alternate Hoeing doth not at all endanger the Roots by being dried by the Sun; for whilst one half of the Roots have Moisture, 'tis sufficient; the other Half will be supplied from those; so that they will soon take hold of the Earth again after being moved by the Hoe.

(*o*) Sometimes, when Turneps are planted late, this alternate Hoeing suffices without any Repetition; but when they are planted early, 'twill be necessary to hoe them again; especially if Weeds appear.

Tho' the Earth on each Side the Row be left as narrow as possible (*p*); yet 'tis very profitable to hoe that little with a *Bidens* (*q*), called here a Prong-hoe (*r*); for this will be sure to let out all the Roots into the Intervals; even such as run very nearly parallel to the Rows.

This alternate Way of Hoeing Plants that grow in single Rows, is of such vast Advantage, that four of these, which are but equal to Two of the *whole* Hoeings in Labour, are near equal to four *whole* Hoeings in Benefit; for when one Side is well nourished, the other Side cannot be starv'd (*s*).

Besides, where a great Quantity of Turneps are to be ho'd, the last ho'd may be stinted, before the first are finish'd by *whole* Hoeings.

In this alternate Hoeing, the Hoe-plough may go deeper (*t*) and nearer to the Row, without Danger of thrusting it down on the Left Side, whilst the Plants are very small; because the Earth on the other Side of the Row always bears against it for its Support: But in the *whole* Hoeing, there is an open Furrow left the first Time on both Sides of the Row, and there is Danger of throwing it into one Furrow in

(*p*) I do not think that we can go nearer to the Plants with the Hoe-plough, than within Three Inches of their Bodies.

(*q*) We ought not to use the *Bidens* for this Purpose, before the perpendicular Roots are as big as one's little Finger.

(*r*) Some of these Prong-hoes have Three Teeth, and are reckoned better as a *Tridens* than a *Bidens*; but this is only in mellow Ground.

(*s*) But yet sometimes the Weeds, or other Circumstances, may make it proper to give them a *whole* Hoeing at first.

(*t*) This deep Plowing so near to the Row is very beneficial at first; but afterwards, when the Plants are grown large, and have sent their Roots far into the Intervals, it would almost totally disroot them; and they, being Annuals, might not live long enough for a new Stock of Roots to extend so far as is necessary to bring the Turneps to their full Bigness.

Note, At the last Hoeing we generally leave a broad, deep Trench in the middle of each Interval.

plowing the other; or, if the Row is not thrown down, it may be too much dry'd in hot Weather, by the Two Furrows lying too long open: Yet, when the Turneps are large before Hoeing, we need not fear either of these Dangers in giving them a *whole* Hoeing; as I have found by Experience, even when there has been left on each Side of the Row only about Three Inches Breadth of Earth; tho' it is not best to suffer it to lie long open (*u*).

Dry Weather does not injure Turneps when Horse-ho'd, as it does sown Turneps; the Hand-hoe does not go deep enough to keep the Earth moist, and secure the Plants against the Drought; and that is the best Season for Horse-hoeing, which always can keep the Roots moist (*x*).

Dung and Tillage together will attain the necessary Degree of Pulveration, in less time than Plowing can do alone: Therefore Dung is more useful for Turneps, because they have commonly less time to grow than other Plants.

Turneps of Nineteen Pounds Weight I have several Times heard of, and of Sixteen Pounds Weight often known; and Twelve Pounds may be reckon'd the middle Size of great Turneps: And I can see no Reason, why every Turnep should not arrive to the full Bigness of its Species, if it did not want Part of its due Nourishment.

(*u*) But, if the Weather prove wet, we always suffer those Furrows to lie open, until the Earth be dry enough to be turn'd back again to the Row, without smearing or sticking together; unless such Weather continue so long that the Weeds begin to come up, and then we throw back the Furrows to stifle the Weeds, before they grow large, tho' the Earth be wet.

(*x*) But if some Sorts of Earth have lain so long unmoved as to become very hard before the first Hoeing, the Hoe, going very near to the Rows on each Side, may cause such hard Earth whereon the Rows stand, to crack and open enough to let in the Drought (*i. e.* the Sun and Air) to the Roots in very dry Weather. In this Case 'tis best to *Horse-hoe* alternately, as is directed in
Page 86.

The greatest Inconvenience, which has been observ'd in the Turnep-husbandry, is, when they are fed off late in the Spring (which is in many Places the greatest Use of them), there is not time to bring the Land in Tilth for Barley; the Loss of which Crop is sometimes more than the Gain of the Turneps: This is intirely remedied by the drilling Method; for, by that, the Land may be almost as well till'd before the Turneps are eaten, or taken off, as it can afterwards.

If Turneps be sown in *June*, or the Beginning of *July*, the most experienced Turnep-Farmers will have no more than Thirty to a square Perch left in Hand-hoeing; and find that when more are left, the Crop will be less; but, in drilling the Rows at Six Feet Intervals, there may be Sixty to a Perch; and the Horse-hoe, by breaking so much more Earth than the Hand-hoe does, can nourish Sixty drill'd, as well as Thirty are by the sowing Method, which has been made appear upon Trial; but, I think, about Forty or Forty-five better than Sixty on a Perch; and the Number of Plants should always be proportion'd to the natural and artificial Pasture which is to maintain them; and sixty Turneps on a square Perch, at Five Pounds each (which is but a Third of the Weight of the large Size of Sheep-Turneps), make a Crop of above Eighty Quarters to an Acre (*y*).

When

(*y*) I have had Turneps upon poor undung'd Land, that weigh'd Fourteen Pounds a-piece; but these were only such as had more Room than the rest. I have seen a whole Waggon-load of drill'd Turneps spread on the Ground, wherein I believe one could not have found one that weighed so little as six Pounds; or if the Rows had been searched before they had been pull'd up, they would have weigh'd Seven or Eight Pounds apiece one with another; we weigh'd some of them that were Thirteen, some Fourteen Pounds each, and yet they stood pretty thick: There might be, as I guess, about Fifty on a square Perch; but this Crop was on sandy Land, not poor; and was dung'd the Third

When Turneps are planted late (especially upon poor Ground), they may be a greater Number than when planted early; because they will not have time enough of Heat to enjoy the full Benefit of Hoeing, which would otherwise cause them to grow larger.

The greatest Turnep-Improvement used by the Farmer, is for his Cattle in the Winter; one Acre of Turneps will then maintain more than Fifty of Meadow or Pasture-ground.

'Tis now so well known, that most Cattle will eat them, and how much they breed Milk, &c. that I need say nothing about it.

Sheep always refuse them at first, and, unless they have eaten them whilst they were Lambs, must be ready to starve before they will feed on them; tho', when they have tasted them, they will be fatted by them; and I have seen Lambs of Three Weeks old scoop them prettily, when those of a Year old (which are called Tegs) have been ready to die with Hunger amongst them; and for Three or Four Days would not touch them, but at last eat them very well.

In some Places, the greatest Use of Turneps (except for fattening Oxen and Sheep) is for Ewes and Lambs in the Spring, when natural Grass is not grown on poor Ground; and if the artificial Grass be then fed by the common Manner, the Crop will be spoil'd, and it will yield the less Pasture all the Summer: I have known Farmers, for that Reason, oblig'd to keep their Ewes and Lambs upon Turneps (tho' run up to Seed) even until the Middle of *April*.

There are now three Manners of spending Turneps with Sheep, amongst which I do not reckon the Way of putting a Flock of Sheep into a large Ground of Turneps without dividing it; for in that Case the

or Fourth Year before; and had every Year a ho'd Crop of Potatoes, or Wheat, until the Year wherein the Turneps were planted.

Flock

Flock will destroy as many Turneps in a Fortnight, as should keep them well a whole Winter.

The First Manner now in Use is, to divide the Ground of Turneps by Hurdles, giving them leave to come upon no more at a Time than they can eat in one Day, and so advance the Hurdles farther into the Ground daily, until all be spent; but we must observe, that they never eat them clean this Way, but leave the Bottoms and Outsides of the Turneps they have scoop'd in the Ground. These Bottoms People pull up with Iron Crooks, made for that Purpose; but their Cavities being tainted with Urine, Dung, and Dirt from their Feet, tho' the Sheep do eat some of the Pieces, they waste more, and many the Crooks leave behind in the Earth; and even what they do eat of this tainted Food, can't nourish them so well as that which is fresh and cleanly.

The second Manner is, to move the Hurdles every Day, as in the First; but that the Sheep may not tread upon the Turneps, they pull them up first, and then advance the Hurdles as far daily as the Turneps are pull'd up, and no farther: By this Means there is not that Waste made as in the other Way; the Food is eaten fresh and clean; and the Turneps are pull'd up with less Labour than their Pieces can be (z).

The Third Manner is, to pull them up, and to carry them into some other Ground in a Cart, or Waggon, and there spread them every Day on a new

(z) I have seen Three Labourers work every Day with their Crooks, to pull up these Pieces, which was done with much Difficulty, the Ground being trodden very hard by the Sheep; when one Person, in Two Hours time, would have pull'd up all the *whole* Turneps daily, and the Sheep would have eaten them clean; but so many of those Pieces were dry'd and spoil'd, that, after the Land was sown with Barley, they appear'd very thick upon the Surface, and there could not be much less than half the Crop of Turneps wasted, notwithstanding the Contrivance of these Crooks.

Place, where the Sheep will eat them up clean, both Leaf and Root: This is done when there is Land not far off, which has more Need of Dung, than that where the Turneps grow, which perhaps is also too wet for Sheep in the Winter; and then the Turneps will, by the too great Moisture and Dirt of the Soil, spoil the Sheep, and in some Soils give them the Rot, yet such Ground will bring forth more and larger Turneps than dry Land; and when they are carry'd off, and eaten on plow'd Ground in dry Weather, and on Green-sward in wet Weather, the Sheep will thrive much better; and that moist Soil, not being trodden by the Sheep, will be in much the better Order for a Crop of Corn. And generally the Expence of Hurdles, and removing them, being saved, will more than countervail the Labour of carrying off the Turneps.

These Three Ways of spending Turneps with Sheep are common to those drill'd, and to those sown in the random Manner; but they must always be carry'd off for Cows and Oxen; both which will be well fattened by them, and some Hay in the Winter: The Management of these is the Business of a Grazier.

C H A P. IX.

Of W H E A T.

TH O' all Sorts of Vegetables may have great Benefit from the Hoe, because it supplies them with Plenty of Food, at the Time of their greatest Need, yet they do not all equally require Hoeing; but the Plant that is to live the longest, should have the largest Stock of Sustenance provided for it: Generally

nerally Wheat lives, or ought to live, longer than other Sorts of Corn; for if it be not sown before Spring, its Grain will be thin, and have but little Flour in it, which is the only useful Part for making Bread. And when sown late in the Winter, 'tis in great Danger of Death from the Frost, whilst weak and tender, being maintain'd (as a *Fetus*) by the umbilical Vessels, until the Warmth of the Sun enables it to send out sufficient Roots of its own to subsist on, without Help of the *Orum*.

To prevent these Inconveniences, Wheat is usually sown in Autumn: Hence, having about thrice the Time to be maintain'd that Spring Corn hath, it requires a larger Supply of Nourishment, in proportion to that longer Time; not because the Wheat in its Infancy consumes the Stock of Food, during the Winter, proportionably to what it does afterwards; but because, during that long Interval betwixt Autumn and Spring Seed-times, most of the artificial Pasture is naturally lost, both in light and in strong Land.

For this very Reason is that extraordinary Pains of fallowing and dunging the Soil, necessary to Wheat; tho', notwithstanding all that Labour and Expence, the Ground is generally grown so stale by the Spring, and so little of the Benefit of that chargeable Culture remains, that, if Part of the same Field be sown in the Beginning of *April*, upon fresh Plowing, without the Dung, or Year's Fallow, it will be as great or a greater Crop, in all Respects, except the Flour, which fails only for want of Time to fill the Grain.

Poor light Land, by the common Husbandry, must be very well cultivated and manur'd, to maintain Wheat for a whole Year, which is the usual Time it grows thereon; and if it be sown late, the greatest Part of it will seldom survive the Winter, on such Land; and if it be sown very early on strong Land, tho' rich, well till'd, and dung'd, the Crop will be worse than on the poor light Land sown early. So
much

much do the long Winter's Rains cause the Earth to subside, and the divided Parts to coalesce, and lock out the Roots from the Stock of Provision, which, tho' it was laid in abundantly at Autumn, the Wheat has no great Occasion of until the Spring; and then the Soil is become too hard for the Roots to penetrate; and therefore must starve (like *Tantalus*) amidst Dainties, which may tempt the Roots, but cannot be attain'd by them.

But the new Method of Hoeing gives, to strong and to light Land, all the Advantages, and takes away all the Disadvantages, of both; as appears in the Chapters of *Tillage* and *Hoeing*. By this Method the strong Land may be planted with Wheat as early as the light (if plow'd dry); and the Hoe-Plough can, if rightly apply'd, raise a Pasture to it (*a*), equal to that of Dung in both Sorts of Land.

About the Year 1701, when I had contrived my Drill for planting St. Foin, I made use of it also for Wheat. Drilling many Rows at once, which made the Work much more compendious, and perform'd it much better than Hands could do, making the Channels of a Foot Distance, drilling in the Seed, and covering it, did not in all amount to more than Sixpence *per* Acre Expence, which was above ten Times over-paid by the Seed that was saved; for One Bushel to an Acre was the Quantity drill'd; there remain'd then no need of Hand-work, but for the Hoeing; and this did cost from Half a Crown to Four Shillings *per* Acre. This way turn'd to a very good Account, and in considerable Quantities; it has brought as good a Crop of Wheat on Barley-stubble, as that sown the common Way on Summer-fallow;

(*a*) Because the Hoe may go in it all the Year, and the Soil being *infinitely divisible*, the Division which the Hoe may make whilst the Crop is growing, added to the common Tillage, may equal, or even exceed, a common Dressing with Dung, as I have often experienced.

and

and when that sown the old Way, on the same Field, on Barley-stubble, intirely fail'd, tho' there was no other Difference but the Drilling and Hoeing: It was also such an Improvement to the Land, that when one Part of a strong whitish Ground, all of equal Goodness, and equally fallow'd and till'd, was dung'd and sown in the common Manner, and the other Part was thus drill'd and hand-ho'd without Dung, the ho'd Part was not only the best Crop, but the whole Piece being fallow'd the next Year, and sown all alike by a Tenant, the ho'd Part produc'd so much a better Crop of Wheat than the dung'd Part, that a Stranger would have believ'd by looking on it, that that Part had been dung'd which was not (*a*), and that Part not to have been dung'd which really was.

Scarce any Land is so unfit, and ill prepar'd, for Wheat, as that where the natural Grass (*b*) abounds. Most other sorts of Weeds may be dealt withal when they come among drill'd Wheat; but 'tis impossible to extract Grass from the Rows: Therefore let that be kill'd before the Wheat be planted.

The Six-foot Ridges being Eleven, on Sixty-six Feet, which is an Acre's Breadth, ought to be made Lengthways of the Field, if there be no Impediment against it; as if it be an Hill of any considerable Steepness, then they must be made to run up and down, whether that be the Length or Breadth of the Piece; for if the Ridges should go cross such a Hill, they could not be well Horse-ho'd; because it would be very difficult to turn a Furrow upwards, close to the Row above it, or to turn a Furrow downwards, without burying the Row below it; and even

(*a*) If the Dung did pulverize as much as the Hoeing, the Cause must be from the different Exhaustion.

(*b*) One Bunch of natural Grass, transplanted by the Plough into a treble Row of Wheat, will destroy almost a whole Yard of it.

when a Furrow is turn'd from the lower Row, enough of the Earth to bury that Row will be apt to run over on the Left-side of the Plough; unless it goes at such a Distance from the Row, as to give it no Benefit of Hoeing.

These Ridges should be made strait and equal: And to make them strait (*c*) all good Ploughmen know how; and they will, by setting up Marks to look at, plow in a Line like the Path of an Arrow: But to make the Ridges equal, 'tis necessary to mark out a Number of them, before you begin to plow, by short Sticks set up at each End of the Piece; and then if one Ridge happen to be a little too broad, the next may be made the narrower; for if the Plough comes not out exactly at the second Stick, the Two Ridges may be made equal by the next Plowing, or by the Drilling; but if many contiguous Ridges should be too wide, or too narrow, 'twill be difficult to bring them all to an Equality afterwards, without levelling the whole Piece, and laying out the Ridges all anew.

The exact Height of Ridges, which is best, I cannot determine (*d*): A different Soil may require a different Height, according to the Depth, Richness, and Pulveration of the Mould. As Wheat covets always to lie dry in the Winter, so there is no other way to keep it so dry as these Ridges; for when they are, after the first Hoeing, about Eighteen Inches

(*c*) But if the Piece be of such a crooked or serpentine Form, that the Ridges cannot well be plow'd strait the first Time, 'tis best to drill it upon the Level; and then the marking Wheels may direct for making the Row all parallel and equidistant; which will guide the Plough to make all the Ridges for the next and all the subsequent Crops, as equal.

(*d*) I find by measuring my Wheat Ridges in the Spring, that none of them are quite a Foot high; and some of them only Six Inches; but I know not how much they have subsided in the Winter; for they were certainly higher when first made.

broad.

broad (*a*); with a Ditch on each Side, of almost a Foot deep, the Rain-water runs off such narrow Ridges as fast it falls, and much sooner (*b*) than 'tis possible for it to do from broad Ridges.

And the deeper the Soil, the more occasion there commonly is of this high Situation; because such Land is wetter for the most Part than shallow Land, where we cannot make the Furrows so deep, nor the Ridges so high (*c*), as in deep Land; for we must never plow below the Staple. I see the Wheat on these ho'd Ridges flourish, and grow vigorously, in wet Weather, when other Wheat looks yellow and sickly.

The same wide Interval, which is ho'd betwixt Ridges the First time, with Two Furrows, must have had Four Furrows, to hoe it on the Level; or else the Furrow, that is turn'd from the Row, would rise up, and a great Part of it fall over to the Left-hand, and bury the Row; but when turn'd from a Ridge, it will all fall down to the Right-hand.

You must not leave the Tops of the Ridges quite so narrow and sharp for Drilling of Wheat, as you may for drilling Turneps; Wheat being in treble Rows, but Turneps generally in single Rows (*d*). This is our Method of making Ridges for the First Crop of drill'd Wheat.

(*a*) This is the Breadth the Ridges are generally left at, when the Furrows are hoed from them, and thrown into the Intervals.

(*b*) Water, when it runs off very soon, is beneficial, as is seen in water'd Meadows; but where it remains long on, or very near the Bodies of terrestrial Plants, it kills them, or at least is very injurious to them.

(*c*) If we should make our Ridges as high on a shallow Soil, as we may on a deep Soil, there would be a Deficiency of Mould in the Intervals of equal Breadth with those of a deep Soil.

(*d*) A single Row taking up less of the Breadth, may be afforded to have more of the Ridge's Depth; because it leaves the Interval wider.

But the Method of making Ridges for a succeeding Crop, after the former is harvested, is best perform'd as follows: In making Ridges for Wheat after Wheat, you must raise them to their full Height, before you plow the old Partitions, with their Stubble, up to them; for if you go about to make the Ridges higher afterwards, the Stubble will so mix with the Mould of their Tops, that it may not only be an Hindrance to the Drill, but also to the First Hoeing; because if the Hoe-plough goes so near to the Rows as it ought, it would be apt to tear out the Wheat-plants along with the Stubble.

In Reaping, we cut as near as we can to the Ground (*a*); which is easily done, because the Stalks stand all close together at Bottom, contrary to those of sown Wheat.

I find this Stubble, when 'tis only mixt with the Intervals, very beneficial to the Hoeing of my Wheat; but I know not whether it may be so in rich miry Land.

As soon as conveniently you can, after the Crop of Wheat is carried off (if the Trench in the Middle of each wide Interval be left deep enough by the last Hoeing), go as near as you can to the Stubble with a common Plough, and turn Two large Furrows into the Middle of the Intervals, which will (*b*) make a Ridge

(*a*) When Wheat is reap'd very low, the Stubble is no great Impediment; and I do this when I am forc'd to enlarge the Breadth of my Ridges, or to change their Bearing, as I do when I find it convenient for them to point Cross-ways of the Field instead of Length ways; as if one End of it be wetter than the other: For 'tis inconvenient, that one End of a Ridge should be in the wet Part, and the other in the dry; because, in that Case, we cannot hoe the dry End without hoeing the wet at the same time; and whilst we attend for the wet Part to become dry, it may happen, that the Season for hoeing the whole (if the Quantity be great) may be lost.

(*b*) 'Tis the Depth and Fineness of this Ridge that the Success of our Crop depends on; the Plants having nothing else to maintain them

Ridge over the Place where the Trench was: But if the Trench be not deep enough, go first in the Middle of it with one Furrow; which with Two more

them during the First Six Months; and if, for want of Sustainance, they are weak in the Spring, 'twill be more difficult to make them recover their Strength afterwards so fully as to bring them to their due Perfection. But Ploughmen have found a Trick to disappoint us in this fundamental Part of our Husbandry, if they are not narrowly watched: They do it in the following Manner; *viz.* They contrive to leave the Trench very shallow; and then, in turning the Two First Furrows of the Ridge, they hold the Plough towards the Left, which raises up the Fin of the Share, and leaves so much of the Earth whereon the Rows are to stand whole and unplow'd, that after once Harrowing there doth not remain above Two or Three Inches in Depth of fine Earth underneath the Rows when drilled, instead of Ten or Twelve Inches.

On a Time, when my Diseases permitted me to go into the Wheat-field, where my Ploughs were at Work, I discovered this Trick, and ventured to ask my chief Ploughman his Reason for doing this in my Absence, contrary to my Direction. He magisterially answer'd, according to his own Theory, which Servants judge ought to be follow'd before that of him they call Master, saying, That as the Roots of Wheat never reached more than Two or Three Inches deep, there was no need that the fine Mould should be any deeper. But those shallow Ridges, which were indeed too many, producing a Crop very much inferior to the contiguous deep Ridges, shew'd, at my Cost, the Mistake of my cunning Ploughman.

'Tis true, that People who examine Wheat-roots when dead, are apt to fall into this mistake; for then they are shrivell'd up, and so rotten, that they break off very near to the Stalk in pulling up; but if they are examined in their Vigour at Summer with Care, in a friable Soil, they may be seen to descend as deep as the fine pulveriz'd Mould reacheth, though that should be a Foot in Thickness.

I took up a Wheat-ear in Harvest that had lain on the Grass in wet Weather, where the Wind could not come to dry it, which had sent out white Roots like the Teeth of a Comb, some of them Three Inches long: None having reached the Ground, they could not be nourish'd from any thing but the Grains, which remained fast to the Ear, and had not as yet sent out any Blade. 'Tis unreasonable to imagine, that such a single Root as one of these, when in the Earth, from whence it must maintain a pretty large Plant all or most Part of the Winter, should descend no farther than when it was itself maintained from the Flour of the Grain only.

taken from the Ridges, will be three Furrows in each Interval; continue this Plowing as long as the dry Weather lasteth; and then finish, by turning the Partitions (whereon the last Wheat grew) up to the new Ridges, which is usually done at Two great Furrows. You may plow these last Furrows, which complete the Ridges, in wet Weather.

To make a Six-foot Ridge very high, will sometimes require more Furrows; as when the Middle of the Intervals are open very wide and deep, then Six Furrows to the whole Ridge may be necessary, and they not little ones; and the Season makes a Difference, as well as the Size of the Furrows; for when the fine Mould is very dry (which is best), it will much of it run to the Left-hand before the Plough, and also more will run back again to the Left after the Plough is gone past it.

But when such Ridges have been made for Wheat, and the Season continues long too dry for planting it, and the Stubble not thrown up, we then plow one deep Furrow on the Middle of each Ridge, and then plow the whole Ridge at Four Furrows more, which will raise it very high. This Way of re-plowing the Ridges moves all the Earth of them, and yet is done at Five Furrows.

The Furrows, necessary for raising up the Ridges, must be more, or fewer, in regard to the Bigness of them; because Six small Furrows may be less than Four great ones. 'Tis not best to plow the Stubble up to the Ridges, until just before Planting (especially in the early Plowing); because that will hinder the Re-plowing of the First Furrows, which, if the Season continues dry, may be necessary: Sometimes we do this by opening One Furrow in the Middle of the Ridge, sometimes Two, and afterwards raise up the Ridges again; and when they are become moist enough at Top (the old Partitions being plow'd up to them), we harrow them
once

once (*a*) (and that only Lengthways); and then drill them.

There is a Necessity of plowing the old Partitions up to the new Ridges, to support their other Earth from falling down by the Harrowing and Drilling, which would else make them level.

Our Ridges, after the First Time of Plowing, excel common Ridges of the same Height; because these, tho' as deep in Mould at the Tops, have little of it till'd at the last Plowing; but ours, being made upon the open Trenches, consist of new-till'd pulveriz'd Mould, from Top to Bottom.

'Tis a general Rule, that all Sorts of Grain and Seeds prosper best, sown when the Ground is so dry, as to be broken into the most Parts by the Plough. The Reason why Wheat is an Exception to that Rule is, because it must endure the Rigours of Winter, which 'tis the better able to do, by the Earth's being

(*a*) But if once be not sufficient to level the Tops of the Ridges fit for the Drill to pass thereon, as it always will, unless the Two hard Furrows lie so high, that all the Three Shares of the Drill cannot reach to make their Channels, in this Case you must harrow again until they can all reach deep enough. Also in some Sort of Land, that when drilled late, and very moist, will stick to the Shares like Pitch or Bird-lime, whereby the Channels are in Part left open by the Drill-harrow, it must be harrowed after 'tis drilled, because 'tis necessary in such Land to take off the common Drill-harrow, in order for a Man to follow the Drill with a Paddle, or else a forked Stick, with which he frees the Sheats of the adhering Dirt; this Harrow being gone, much of the Seed will lie uncovered, and then must be covered with common Harrows; unless a Drill-harrow, which was not in Use when my Plates were made, be placed instead of that taken off: This, with its two Iron *Tines*, will cover the Seed in this Case much better than common Harrows, and will be no Hindrance to cleansing of the Sheats, the Legs by which this Harrow is drawn, being remote from them, placed at near the End of the Plank; and *note*, that the most proper Drill for this Purpose is one that has only Two Shares, standing a Foot or fourteen Inches asunder: This Harrow serves for taking up the Drill to turn it.

press'd or trodden harder, and clofer to it (*a*), as it is when moved wet.

If Wheat were as hardy as Rye, and its Roots as patient of Cold, it might, no doubt, be sown in as dry a Season as Rye is, and prosper the better for it, as Rye doth. This will appear, if Wheat and Rye be both sown in the same dry Season, after the Winter is over.

But as Wheat requires to have the Earth lie harder on and about it, in the Winter; so it also requires more Dung (or somewhat else) to dissolve the Earth about its Roots, after the cold Winter is past, than Rye doth, whose Roots never were so much confined.

'Tis another general Rule, that all Sorts of Vegetables thrive best, when sown on fresh till'd Ground, immediately after 'tis plow'd.

Wheat is an Exception to this Rule also; for 'tis better to plow the Ground dry, and let it lie till the Weather moistens it (tho' it be several Weeks), and then drill the Wheat: The Harrows and the Drill will move a sufficient Part of the Ground, which will stick together for Defence of the small Roots, during the Winter, the rest of the Mould, lying open, and divided underneath until Spring, to nourish them.

There is a Sort of binding Sand, that requires not only to be plow'd dry, but sow'd dry also; or else the Wheat will dwindle in the Spring, and fail of being a tolerable Crop.

But what I mean by dry Plowing is, not that the Land should always be so void of Moisture, as that the Dust should fly; but it must not be so wet, as to stick together (*b*). Neither should we drill when

(*a*) 'Tis for that Reason, that Farmers drive their Sheep over very light Land, as soon as 'tis sown with Wheat, to tread the (Top or) Surface of it hard: and then the Cold of the Winter cannot so easily penetrate, to kill the Roots of the tender Plants.

(*b*) But the dust 'tis plow'd the better

the Earth is wet as Pap; it suffices that it be moist, but moister in light Land than in strong Land, when we drill.

If the Two Furrows, whereon the treble Row is to stand, be plow'd wet, the Earth of the Partitions may grow so hard by the Spring, that the Roots cannot run freely therein, unless there be Dung to ferment and keep it open.

So we see, that a steep Bank, made of wet Earth, will lie fast for several Years, when another, made of the same Earth dry, will moulder, and run down very soon; because its Parts have not the Cohesion that holds the other together, it continues open, and more porous, and crumbles continually down.

I have seen Trials of this Difference betwixt plowing Dry, and plowing Wet, for planting of Wheat, both in the Old Way, and in the Drilling Way, but most in the latter; and never saw an Instance where the Dry-Plowing did not outdo the Wet; if the Wheat was not planted thereon before the Earth was become moist enough at Top.

And strong Land, plow'd wet in *November*, will be harder in the Spring, than if plow'd dry in *August*; tho' it would then have Three Months longer to lie.

After Rain, when the Top of the Ground is of a fit Moisture for Drilling, harrow it with Two light Harrows, drawn by a Horse going in the Furrow betwixt Two Ridges (*a*); once will be enough, the Furrow being just broken to level, or rather smooth it for the Drill.

If the Veerings (*b*) whereon the next Drop is to stand, be plow'd dry, we may drill at any Time during

(*a*) Once Harrowing is generally enough, but not always.

(*b*) The Word veering is, I believe, taken from the Seamen, and signifies to turn: It is the Ploughman's Term for turning Two Furrows toward each other, as they must do to begin a Ridge:

during the common and usual Wheat-feed time, that is proper for the sort of Wheat to be drill'd, and the sort of Land, whether that be early or late, we may drill earlier, but not later than the sowing Farmers. But I have had good Crops of Wheat drill'd at all Times betwixt Harvest and the Beginning of *November*.

For the Benefit of the middle Rows, 'tis better not to drill Wheat on strong Land before the usual Season; because the later 'tis planted, the more open the Partitions will be for the Roots of those Rows to run through them in the Spring: and yet, if the Earth of the Partitions be plow'd very wet, tho' late, they may be harder at the Spring, than those which are plow'd early and dry.

There is a Sort of Wheat call'd by some (*a*) *Smyrna Wheat*: It has a prodigious large Ear, with many less (or collateral) Ears, coming all round the Bottom of this Ear; as it is the largest of all Sorts of Wheat, so it will dispense with the Nourishment of a Garden, without being over-fed, and requires more Nourishment than the common Husban-

and therefore they call the Top of a Ridge a Veering; they call the Two Furrows that are turn'd from each other at the Bottom, between Two Ridges, a Henting, *i. e.* an Ending: because it makes an End of plowing Ridges.

Our Intervals wholly consist of Veerings or Hentings; when Two Furrows are turn'd from the Rows, they make a Veering; when turn'd towards the Rows, they are a Henting, which is the deep wide Trench in the Middle of an Interval.

(*a*) 'Tis said to grow mostly in some Islands of the *Archipelago*, and some Author describes it *Triticum spica multiplici*: There is another Sort of Wheat that has many little Ears coming out of Two Sides of the main Ear, but this is very late ripe, and doth not succeed well here, nor is it liked by them who have sown it; yet I have had some Ears of it by chance among my drill'd Wheat, which have been larger than those of any common Sort. I have not as yet been able to procure any of the *Smyrna Wheat*, which I look on as a great Misfortune; but I had some of it above Forty Years ago.

dry will afford it; for there its Ears grow not much bigger than those of common Wheat: This I believe to be, for that Reason, the very best Sort for the Hoeing Husbandry; next to this I esteem the White-cone Wheat, then the Grey-cone. I have had very good Crops from other Sorts; but look upon these to be the best.

When Wheat is planted early, less Seed is required than when late; because less of it will die in the Winter than of that planted late, and it has more Time to tiller (*a*).

Poor Land should have more Seed than rich Land, because a less Number of the Plants will survive the Winter on poor Land.

The least Quantity of Seed may suffice for rich Land that is planted early; for thereon very few Plants will die; and the Hoe will cause a small Number of Plants to send out a vast Number of Stalks, which will have large Ears; and in these, more than in the Number of Plants, consists the Goodness of a Crop (*b*).

Another thing must be consider'd, in order to find the just Proportion of Seed to plant; and that is, that some Wheat has its Grains twice as big as other Wheat of the same Sort; and then a Bushel (*c*) will contain but half the Number of Grains; and one Bushel of Small-grain'd Wheat will plant as much Ground as Two Bushels of the Large-grain'd; for, in Truth, 'tis not the Measure of the Seed, but the Number of the Grains, to which respect ought to be had in apportioning the Quantity of it to the Land.

(*a*) To *tiller* is to branch out into many Stalks, and is the Country Word, that signifies the same with *fruticare*.

(*b*) A too great Number of Plants do neither tiller, nor produce so large Ears, nor make half so good a Crop, as a bare competent Number of Plants will.

(*c*) Our Bushel contains Seventy Pounds of the best Wheat.

Some

Some have thought, that a large Grain of Wheat would produce a larger Plant than a small Grain; but I have full Experience to the contrary. The small Grain, indeed, sends up its first single Blade in Proportion to its own Bulk, but afterwards becomes as large a Plant, as the largest Grain can produce (*a*), *ceteris paribus*.

Six Gallons of middle-siz'd Seed we most commonly drill on an Acre; yet, on rich Land planted early, Four Gallons may suffice; because then the Wheat will have Roots at the Top of the Ground before Winter, and tiller very much, without Danger of the Worms, and other Accidents, that late-planted Wheat is liable to.

If it is drill'd too thick, 'twill be in Danger of falling; if too thin, it may happen to tiller so late in the Spring, that some of the Ears may be blighted; yet a little thicker or thinner does not matter.

As to the Depth, we may plant from half an Inch, to three Inches deep; if planted too deep, there is more Danger of its being eaten off by Worms, betwixt the Grain and the Blade (*b*); for as that

(*a*) Farmers in general know this, and choose the thinnest, smallest-grained Wheat for Seed; and therefore prefer that which is blighted and lodged, and that which grows on new-broken Ground, and is not fit for Bread; not only because this thin Wheat has more Grains in a Bushel; but also because such Seed is least liable to produce a smutty Crop, and yet brings Grains as large as any.

I myself have had as full Proofs of this as can possibly be made in both Respects.

'Twas from such small Seed that my drill'd *Lammis* Wheat produced the Ears of that monstrous Length described in this Chapter. I never saw the like, except in that one Year; and the Grains were large also.

And as full Proofs have I seen of thin Seed-wheat escaping the Smut, when plump large grain'd Seed of the same Sort have been smutty.

(*b*) A Wheat plant, that is not planted early, sends out no Root above the Grain before the Spring; and is nourish'd all the Winter by a single Thread, proceeding from the Grain up to the Surface of the Ground. Thread

Thread is the Thread of Life during the Winter (if not planted early), so the longer the Thread is, the more Danger will there be of the Worms (*a*).

'Tis a necessary Caution to beware of the Rooks (*b*), just as the Wheat begins to peep; for before

(*a*) Because the Worms can more easily find a Thread, that extends by its Length to five or six Inches Depth, than one which reaches but One Inch; and besides, the Worms in Winter do not inhabit very near the Surface of the Ground; and therefore also miss the short Threads, and meet with the long ones.

(*b*) 'Tis true, that Wheat which is planted early enough for its Grain to be unfit for the Rooks, before the Corn that is left on the Ground at Harvest is either all eaten by them, or by Swine, or else grow'd, plowed in, or otherwise spoiled, is in no Danger: but as this sometimes happens soon after Harvest, the Time of which is uncertain, a timely Care is necessary.

Many are the Contrivances to fright the Rooks; *viz.* To dig an Hole in the Ground, and stick Feathers therein; to tear a Rook to Pieces, and lay them on divers Parts of the Field: This is sometimes effectual; but Kites or other Vermin soon carry away those Pieces. Hanging up of dead Rooks is of little Use; for the living will dig up the Wheat under the dead ones. A Gun is also of great Use for the Purpose; but unless the Field in Time of Danger be constantly attended the Rooks will at one Time or other of the Day do their Work, and you may attend often, and yet to no Purpose; for they will do great Damage in your Absence.

The only Remedy that I have found infallible is a Keeper (a Boy may serve very well) to attend from Morning until Night; when he sees Rooks either flying over the Field, or alighted in it, he halloos, and throws up his Hat, or a dead Rook, into the Air: upon which they immediately go off; and 'tis seldom that any one will alight there: They, finding there is no Rest for them, seek other Places for their Prey, wherein they can feed more undisturbed.

This was the Expedient I made use of for preserving my present Crop: It succeeded so well, that in Sixscore Acres, I believe there is not Two-pence Damage done by the Rooks; but I had two Boys (one at Four-pence, and the other at Three-pence a Day) to attend them; because my Wheat is on Two Sides of my Farm; the whole Expence was about Twenty Shillings. The Damage I received by Rooks the last Year in a Field of Seventeen Acres, was more than would have, in this manner, preserved my whole Crops for Twenty Years running. I wish I could as easily defend my Wheat against Sheep, which are to me a more pernicious Vermin than the Rooks.

you can perceive it to be coming up, they will find it, and dig it up to eat the Grain; therefore you must keep them off for a Week or Ten Days; and in that time the Blade will become green, and the Grain so much exhausted of its Flour, that the Rooks think it not worth while to dig after it.

But the Rooks do not molest Wheat that is planted before or a little after *St. Michael*; for then there remains Corn enough in the Fields, which is left at Harvest above-ground, that Rooks prefer always before Corn which must cost them the Labour of digging to find it.

Of Partitions.

I have now intirely left out the middle Row for Wheat, and keep only to the double Row, for the following Reasons.

It makes the cleansing from Weeds more difficult, than when there is only a double Row.

The Hand-hoe cannot give near so much Nourishment (*i. e.* pulverize so much Earth) in Two Seven-inch Partitions, as it can in One Ten-inch Partition.

There is Four Inches less Earth to be pulveriz'd by the Horse-hoe from the Surface of a Ridge that has Two Seven-inch Partitions, than from a Ridge that hath One Ten-inch Partition.

The Ridge must be almost twice as deep in Mould for the treble as for the double Row, or else the middle Row will be very weak and poor; and then, according to the Principles, the whole Ridge will be more exhausted, than by an equal Product produced by strong Plants.

As the Ridges may be much lower that have only the one Partition, so the Intervals may be narrower, and yet have as much Earth in them to be pulveriz'd, as in wide ones that are betwixt treble Rows; because the Four Inches that are in the two Partitions more than in the single Partition, being on the Top of the

the Ridge, may have more Mould under them than Eight Inches on the Side of a Ridge ; and the Four Inches, being in the Partitions, lose the Benefit of Horse-hoeing.

Instead of using the middle Row as an Alloy, 'tis better to plant such Sorts of Wheat as do not require any Alloy to the double Row ; and these are the *White-cone*, and above all other Sorts the right *Smyrna*.

The *White-cone* Wheat must not be reaped so green as the *Lammas* Wheat may ; for if it is not full-ripe, it will be difficult to thresh it clean out of the Straw.

It happened once that my *White-cone* being planted early, and being very high, the Blade and Stalk were kill'd in the Winter ; and yet it grew high again in the Spring, and had then the same Fortune a Second time ; it lay on the Ridges like Straw, but sprung out anew from the Root, and made a very good Crop at Harvest : Therefore, if the like Accident should happen, the Owner needs not be frighted at it.

One thing that made Six-foot Ridges seem at first necessary, was the great Breadth of the Two Partitions (which were Eight Inches apiece), which, together with the Earth left on each Side of the treble Row not well cleansed by Hand-work, made Two large whole Furrows, at the first Plowing for the next Crop, that could not be broken by Harrows : These Two strong Furrows, being turned to the Two Furrows that are in the middle of a narrow Interval, for making a new Ridge, would cover almost all the pulveriz'd Earth, not leaving room betwixt the Two whole Furrows for the Drill to go in. But now the single Partition, and the Earth left by the Hoe-Plough, on the Outsides of the double Row, making Two narrow Furrows, and the one Partition being cleansed, and deeper Hand-ho'd than those of the treble Row were, or could be, are easily broken by the
Harrows ;

Harrows; for, besides their Narrowness, they have no Roots to hold their Mould together, except the Wheat-roots, which, being small and dead, have not Strength enough to hold it; and therefore that Necessity of such broad Ridges now ceases along with the treble Row.

When the Two narrow fragile Furrows are harrowed, and mixed with the pulveriz'd Earth of the Intervals, the Roots of the Wheat will reach it; and it is no Matter whether the Crop be drill'd after Two Plowings, in which Case the Row will stand on the very same Place whereon the Row stood the precedent Year, or whether it be drill'd after One or Three Plowings; and then the Rows will stand on the Middle of the last Year's Intervals.

I cannot prescribe precisely the most proper Width of all Intervals; because they should be different in different Circumstances. In deep rich Land they may be a little narrower than in shallow Land.

There must be (as has been said) a competent Quantity of Earth in them to be pulveriz'd; and, when the Soil is rich, the less will suffice.

Never let the Intervals be too wide to be Horse-hoed at Two Furrows, without leaving any Part unplowed in the Middle of them, when the Furrows are turned towards the Rows.

Some Ploughmen can plow a wider Furrow than others, that do not understand the setting of the Hoe-plough so well, can.

By making the Plank of the Hoe-plough shorter, and the Limbers more crooked, we can now hoe in narrower Intervals than formerly, without doing any Damage to the Wheat.

I now choose to have Fourteen Ridges on an Acre, and one only Partition of Ten Inches on each of them. This I find answers all the Ends I purpose. If the Partitions are narrower, there is not sufficient room in them for the Hand-hoe to do its work effectually.

ally ; if wider, too much Earth will lose the Benefit of the Horse-hoe.

The poorer the Soil is, the more Pulveration will be necessary to it.

When a great Season of Wheat is drill'd, it cannot be expected that much of it can be plowed dry, tho' it is advantageous when there happens an Opportunity for doing it ; but by long Experience I find, that in most of my Lands it does very well, when plowed in a moderate Temper of Moisture.

It may not be amiss to harrow it once after it is drill'd, which will, in some Measure, disappoint the Rooks ; besides covering the Wheat, if, perchance, any should miss being covered by the Drill-harrow.

But these, and all Harrows that go on a Ridge, both before and after it is drill'd, should be very light, and fastened together in the common Manner ; except that the Pole must be fastened to each Harrow in two Places ; which keeps them both as level as if they were One single Harrow : Otherwise the Ridges would be too sharp at the Top, and the Partitions would lie higher than the Rows, and some of their Earth would be apt to fall on the Rows when it is Hand-hoed.

By Means of this level Harrowing, there is left an open Furrow in the Middle of the Interval, which much facilitates the First Horse-hoeing.

But when, after a Crop is taken off, the Ridges are plowed twice, as they may be where the one Partition hath been well Hand-ho'd ; 'tis better to harrow the first-made Ridges in the common Manner ; because then some of the fine Earth, that is harrow'd down, will reach to the middle of the Intervals whereon the Ridges are to be made for Drilling : Or if there should be time for plowing thrice, the Ridges of the First and Second Plowings are to be harrow'd in the common Manner also.

The Harrowing of Ridges must never be cross-ways, unless they are to be made level for Cross-plowing, in order to lay out the Ridges of a Breadth different to what they were of before.

When you perceive the Ridges are too high, harrow them lower by the described manner of Harrowing; first with the heavy Harrows for harrowing out the Stubble, and then with light ones, which may be often, for making the Earth on the Ridges the finer for Drilling, without throwing much of it down; frequent Harrowings in this manner, not being injurious like too much Harrowing on level Ground, which is sometimes trodden as hard as the Highway by the Cattle that draw the Harrows; for in harrowing these Ridges, the Beast draws the Two Harrows, and always treads in the Furrow between them where there is none or very little Mould to tread on.

The Price of Hand-hoeing of these double Rows is a Penny for thirty Perches in Length of Row, which amounts to between Eighteen and Nineteen Pence for an Acre.

I should say, that in Hand-hoeing the Earth must never be turned towards the Wheat; for, if it were, it might crush it when young; neither could the Partition be clean hoed.

The Hand-hoes for hoeing the Ten-inch Partition have their Edges Seven Inches long; they are about Four Inches deep from the Handle; if they were deeper, they would be too weak; for they must be thin, and well steeled. The Labourers pay for them, and keep them in Order, for their own Use.

These Hoes must not cut out any Part of the Two Rows, nor be drawn through them, as the Four-inch Hoes sometimes may through the treble Rows.

If I am taxed with Levity in changing my treble Rows for double ones, it will not appear to be done of a sudden. In *p.* 132. I advised the Trial of both
Sorts :

Sorts: And now, upon fuller Experience, I find the double Rows much preferable to the treble, especially for Wheat.

When Gentlemen saw the middle Row on low Ridges so much inferior to the outside Rows, they were convinced of the Effect of deep Hoeing; for they said, there was no other Reason for this so visible a Difference, except the outside Rows standing nearer to the pulveriz'd Intervals than the middle Row did.

And when on high Ridges the middle Row was nearly or quite as good as one of the outside Rows, I was not convinced, that they were not diminished by the middle Row, as much as the Produce of it amounted to: And this I now find to be the Case; for Four Rows of Oats, without a middle Row, produced somewhat more than the same Number that had a middle Row; Two of which treble Rows were taken on one Side, and Two on the other Side of the double Rows, purposely to make an unexceptionable Trial. And it is, as far as I can judge, the same in Wheat.

'Tis true, I began my Horse-hoeing *Scheme* first with double Rows; but then they were different to what they are now; for the first had their Partition uneven, being the parting Space, whereby it was less proper for Hand-hoeing, which I then seldom used, except for absolute Necessity, as to cleanse our Poppies, and the like. The Intervals also were too narrow for constant annual Crops.

By all these Three Methods I have had very good Crops; but as this I now describe is the latest, and is (as it ought to be) the best; I publish it as such, without Partiality to my own Opinions; for I think it less dishonourable to expose my Errors, when I chance to detect them, than to conceal them: And as I aim at nothing but Truth, I cannot, with any Satisfaction to myself, suffer any thing of my own

knowingly to escape, that is in the least contrary to it.

I have a Piece of Five or Six Acres of Land which I annually plant with boiling Pease, in the very same manner as Wheat; except that the Second Horse-hoeing (which is the last) throws the Earth so far upon the Pease as to make the Two Rows become One. These Pease cannot be planted until after the 25th of *March*; else Two Horse-hoeings might not be sufficient. The same Drill that plants Wheat plants Pease; only sometimes we change the Spindle for one that has its Notches a little bigger.

I drill no more Barley, because 'tis not proper to be followed by a Crop of Wheat without a Fallow; for some of the shattered Barley will live over the Winter, and mix with the Wheat in the Rows, and can scarce possibly be thence timely taken out, its first Stalk and Blade being difficult to distinguish from the Wheat; and this is a great Damage to the Sale in the Market; and for the same Reason I plant no more Oats.

The First Hoeing is performed by turning a Furrow from the Row.

We are not so exact as to the Weather in the First Hoeing; for if the Earth be wet, the Hoe-plough may go nearer to the Row, without burying the Wheat; and the Frost of the Winter will pulverize that Part of the (*a*) Furrow, which is to be thrown to the Wheat in the Spring, altho' it was hoed wet.

Neither is it necessary to be very exact as to Time; but it must never be till the Wheat has more than One Blade; and it may be soon enough, when it has Four or Five Leaves, so that it is done before (*b*), or in the Beginning of Winter.

The

(*a*) The Word Furrow signifies the Earth that is thrown out, as well as the Trench from whence it is thrown by the Plough.

(*b*) But if the Wheat is planted very late, it may not be *hoed* before the Winter is past; nor is there such a Necessity of hoeing

The greatest Fault you can commit in Hoeing, is the First Time, when the Furrow is turned from the Row, not to go near enough to it, nor deep enough. You cannot then go too near it, unless you plow it out, or bury it with Mould, and do not uncover it; nor too deep, unless you go below the Staple of the Ground.

Servants are apt to hoe too far from the Rows, going backwards and forwards, in the Middle of the Intervals, without coming near the Rows: This loses most of the Benefit of Hoeing, and is very injurious to the present Crop, and also to the Two succeeding Crops; for then there will be a Deficiency of pulverized Earth; and nobody can suppose, that the hoed Earth can be of any Benefit to the Rows, before the Roots reach into it; and when 'tis far off, few of the Roots reach it at all; and those that do reach, come there too late to bring the Plants to their full Perfection: Therefore, if the First Furrow was not near enough, nor deep enough, plow a Second Furrow at the Bottom of the former, which will go deeper than the First, and break the Earth more; besides taking away from the Rows such unmoved Ground, which the First Plowing may possibly have missed. If this can't be conveniently done soon after the First Hoeing, do it before the Ridge is turned back in the Spring.

Always leave the Furrows turned up, to make (a) Ridges in the Middle of the Intervals during the Winter;

hoeing the late planted before the great Frosts are over, as there is of the early-planted; for the later 'tis planted, the less time the Earth has to subside, and grow hard.

Note, By Winter we do not mean only those Months that are properly so reckoned, but also such other Months as have hard Frosts in them, as *January, February,* and sometimes the Beginning of *March.*

(a) Tho' the Ridge in the Middle of the Interval should, for Want of sufficient Mould, or otherwise, be too low to give Shelter,

Winter; and then the hollow Furrows, or Trenches next the Rows, being enriched by the Frost (*b*) and Rains (*c*), the Wheat will have the Benefit of them earlier in the Spring, than if the Trenches had been left open in the Middle of the Intervals.

The outside Rows of Wheat, from which the Earth is hoed off before or in the Beginning of Winter,

ter, yet there is generally some Earth falls to the Left of the Hoe-plough, and lodges upon that Part which is left on the Outside of the Row; which, notwithstanding that Part be very narrow (as suppose Two or Three Inches), yet a small Quantity of Earth lying thereon, so near to the outside Row, gives an extraordinary Shelter to the young Wheat plants that grow in it.

Shelter is a great Benefit to Wheat; but yet Nourishment is more: for in the Winter I see the Wheat-plants upon the most exposed Part of the Ridge flourish, when single Plants in the Bottom of the Furrow are in a very poor languishing Condition, without any Annoyance of Water, they being upon a Chalk Bottom.

(*b*) Frost, if it does not kill the Wheat, is of great Benefit to it; Water or Moisture, when it is frozen in the Earth, takes up more Room than in its natural State; this Swelling of the Ice (which is Water congealed) must move and break the Earth where-with it is mixt; and when it thaws, the Earth is left hollow and open, which is a kind of Hoeing to it. This Benefit is done chiefly to and near the Surface; consequently the more Surface there is, by the Unevenness of the Land, the more Advantage the Soil has from the Frost.

This is another very great Use of the Ridge left in the Middle of the Interval during the Winter; because that Ridge, and its Two Furrows, contain Four Times as much Surface as when level. This thus pulverized Surface, turned in in the Spring hoeing, enriches the Earth, in proportion to its Increase of internal Superficies, and likewise proportionably nourishes the Plants, whose Roots enter it; and that Part of it wherein they do not enter, must remain more enriched for the next Crop, than if the Soil had remained level all the Winter.

(*c*) It is a vulgar Error that the Winter Rains do not enrich the Earth; and is only thought so, because we do not see the Effect of them upon Vegetables, for lack of Heat in that Season. But some Farmers have frequently observed, that one half of a Ground plowed up just before Winter has produced a Crop of Barley as much better than the other Part plowed up at the End of Winter, as is the Difference of a Dugging, even when there has been very little Frost.

and

and left almost bare till the Spring, one would think should suffer by the Frost coming so near them (*d*), or for want of Pasture: But it appears to be quite contrary; for where the Hoe has gone nearest to a Row, its Plants thrive best: The Earth, which the Frost hath pulverized, being within the Reach of the young short Roots, on that Side of the Row, from the Top to the Bottom of the Trench, nourishes them at first; and before the Plants have much exhausted this, as they grow larger in the Spring, the Ridge from the Middle of the Interval is thrown to them, having a perfectly unexhausted Pasture, to supply their increasing Bulk with more Nourishment.

The Row standing as it were on the Brink of this almost perpendicular Ditch, the Water runs off quickly, or doth not enter but a very little Way into this steep Side; so that, the Earth at the Plants being dry, the Frost doth not reach quite to all their Roots to hurt them, tho' the Distance from the Air to the Roots be very short; and dry Earth doth not freeze as wet doth, neither is this Ditch much exposed to the cold Winds.

The Spring-hoeing is performed after the great Frosts are past, and when the Weather will allow it; and then turn (*e*) the Ridge from (*f*) the Middle of the

(*d*) In very light Land, perhaps, we must not hoe quite so near to the Rows of Wheat, as in strong Land, for fear the Winter should lay the Roots bare, and expose them too much to the Cold; but then we may be sure, that, in this Case, the Roots will reach the Interval at a greater Distance than in strong Land; yet such very light Land is not proper for Wheat.

(*e*) 'Tis an errant Mistake of the Vulgar, when they imagine that the immediate Benefit of fresh Earth to Plants is from that Part which remains uppermost; for 'tis from turning the impregnated pulverized Side downwards, to be fed on by the Roots, that gives the *Pabulum* or Nourishment of the fresh Earth to Plants: The other Side, being turned upwards, becomes impregnate also in a little time.

(*f*) But note, that when we see Weeds coming up near the Row in the Spring, we plow again from the Rows (and some-

the Interval, to the Rows on each Side by Two Furrows as near as can be, without covering the Wheat; in doing which have regard to the Row only, without looking at the Middle of the Interval; for 'tis no matter if a little Earth be left there; the next Hoeing, or the next save one (*g*), will move it.

As to how many times Wheat is to be hoed in the Summer, after this Spring Operation, it depends upon the Circumstances (*b*) and Condition of the Land (*i*) and Weather (*k*); but be the Season as it will, never suffer the Weeds to grow high, nor let any unmoved Earth lie in the Middle of the Intervals long enough to grow hard; neither plow deep near the Rows in the Summer, when the Plants are large (*l*), but as deep in the Middle of the Intervals

times can plow within one Inch of the Row) before we turn down the Mould from the Middle of the Interval.

(*g*) If at the next Hoeing we turn another Furrow towards the Row (which is seldom done), then 'tis the next that moves the remaining Earth, left in the Middle of the Interval: But if the next Hoeing be from the Row (as it generally is), then that covers the Middle of the Interval: and then 'tis the next Hoeing after that, that turns all the Earth clean out of the Middle of the Interval toward the Rows.

(*b*) If the Land was not sufficiently tilled or hoed in the precedent Year, it will require the more Hoeings in the following Year.

(*i*) The poorer the Land is, the more Hoeings it should have.

(*k*) A wet Summer may prevent some of the Hoeings that we should perform in a dry Summer.

(*l*) Our Hoeing deep near the Plants, when small, breaks off only the Ends of the Roots; but after the Roots are spread far in the Interval, the greatest Part of them, being then on the Right-hand Side of the Hoe plough, might hold fast on that Side, and not be drawn out; and then the whole Roots would be broken off close to the Bodies of the Plants: Therefore at the Second deep Hoeing, that turns a Furrow from the Row in the Summer, we go about Four or Six Inches farther off from the Roots than the time before; but we go nearer or farther off, according to the Distance of Time between those Two Hoeings: Yet we may hoe shallow near to the Plants at any time, without Injury to their Roots, but, on the contrary, it will be advantageous to them.

as the Staple will allow ; turning the Earth towards the Wheat, especially at the last Hoeing, so as to leave a deep, wide Trench in the Middle of each Interval.

We augment our Wheat-crops Four Ways ; not in Number of Plants, but in Stalks, Ears, and Grains.

The First is, by increasing the Number of Stalks from One, Two, or Three, to Thirty or Forty to a Plant, in ordinary Field-land.

And we augment the Crop, by bringing up all the Stalks into Ears, which is the Second Way ; for, if it be diligently observed, we shall find, that not half (*m*) the Stalks of sown Wheat come into Ear.

I saw an Experiment of this in Rows of Wheat that were equally poor : One of these Rows was increased (*n*) so much, as to produce more Grains than Ten of the other, by bringing up more of its Stalks into Ears, and also by augmenting its Ears to a much greater Bigness ; which is the Third Way : For, whatever *Varro* means by saying, that the Ears remain Fifteen Days in *Vaginis*, 'tis pretty plain, that the Ears are formed together with the Stalks, and will be very large, or very small, in proportion to the Nourishment given them (*o*).

The last and Fourth Way of augmenting the Produce of Wheat-plants, is by causing them to have large and plump Grains in the Ears ; and this can no way be so effectually done as by late Hoeing, especi-

(*m*) If a square Yard of sown Wheat be marked out, and the Stalks thereon numbered in the Spring, it will be found, that Nine parts in Ten are missing at Harvest.

(*n*) These Rows were drilled a Foot asunder, not hoed ; and were, by the Shallowness and Wetness of the Soil, very poor in the Spring ; and then, by pouring Urine to the Bottom of this Row, it was so vastly increased above the rest.

(*o*) Like as the Vines, if well nourished, bring large Bunches of Grapes ; but if ill nourished, they produce few Bunches, and those small ones ; and many Claspers are formed, which would have been Bunches, if they had had sufficient Nourishment given them at the proper time.

ally just after the Wheat is gone out of the Blossom; and when such hoed Grains weigh double the Weight of the same Number of unhoed (which they frequently will) tho' the Number of Grains in the hoed are only equal, yet the hoed Crop must be double.

Thus, by increasing the Number of Stalks (*p*), bringing more of them up into Ear (*q*), making the Ears larger (*r*), and the Grain plumper, and fuller of Flour (*s*), the Hoeing Method makes a greater Crop
from

(*p*) The same Plant that, when poor, sends out but Two or Three Tillers, would, if well nourished by the Hoe, or otherwise, send up a Multitude of Tillers, as is seen in hoed Wheat, and sown Wheat.

(*q*) Mr. *Houghton* relates Eighty Ears on one single Plant of Wheat, and a greater Number has been counted lately in a Garden: Those Eighty, reckoned to have Fifty Grains apiece, make an Increase of Four thousand Grains for one; but I have never found above Forty Ears from a single Plant in my Fields; yet there is no doubt, but that every Plant would produce as many as Mr. *Houghton's*, of the same Sort, with the same Nourishment: But I should not desire any to be so prolific in Stalks, lest they should fail of bringing such a Multitude of Ears to Perfection. The Four hundred Ears, that I numbered in a Yard, were not weighed, because they were told before ripe; and the greatest Weight of Wheat that ever I had from a Yard, was the Product of about Two hundred and Fifty Ears, and some of them were small.

(*r*) I have numbered One hundred and Nine Grains in One Ear of my hoed Cone-wheat of the grey Sort; and One Ear of my hoed Lammas-wheat has been measured to be Eight Inches long, which is double to those of sown Wheat. I have some of these Ears now by me almost as long, the longest being given away as a Rarity; and indeed 'tis not every Year that they grow to that Length, and 'tis always where the Plants are pretty single. But there is no Year wherein One Ear of my hoed does not more than weigh Two of the sown Ears, taking a whole Sheaf of each together without choosing. The Sheaves of the hoed are of a different Shape from the other; almost all the Ears of the hoed are at the Top of the Sheaf; but most of the other are situate at the lower Part, or near the Middle of the Sheaf.

(*s*) Seed Cone wheat coming all out at the same Heap, planted all at the same Time, and on Land of the same Sort adjoining near together, the Wheat that was sown produced Grains so small,
and

from a Tenth Part of the Plants (*t*) that the sowing Method can.

All

and that which was drilled so very large, that no Farmer or Wheat-buyer would believe them to be of the same Sort of Wheat, except those who knew it, which were many. One Grain of the drilled weighed Two of the sown, and there was twice the Chaff in an equal Weight of the sown, being both weighed before and after the Wheat was separated from the Chaff.

(*t*) The Fact of this nobody can doubt, who has observed the different Products of strong and of weak Plants, how the one exceeds the other.

The greatest Difference of having an equal Crop from a small Number of strong Plants, and from a great Number of weak ones, is, that the Soil is vastly less exhausted by the former than by the latter, not only from the latter's exhausting more in proportion to their Number when young, and whilst each of them consumes as much Nourishment as each of the small Number; but also from the different Increase that a strong Plant makes by receiving the same Proportion of Food with a weak one: For it appears from Dr. *Woodward's* Experiments, that the Plant which receives the *least* Increase carries off the *greatest* Quantity of Nourishment in proportion to that Increase; and that 'tis the same with an Animal, all who are acquainted with fattening of Swine know; for they eat much more Food daily for the first Two Weeks of their being put into the Sty, than they do afterwards, when they thrive faster; the fatter they grow, the less they eat.

Hence, I think, it may be inferred, that a Plant, which, by never having been robbed or stinted by other Plants, is strong, receives a much greater Increase from an equal Quantity of Food, than a Number of weak Plants (as thick ones are), equalling the Bulk of the single strong Plant, do.

And this of the Doctor's have I seen by my own Observations confirmed in the Field in Potatoes, Turneps, Wheat, and Barley; a following Crop succeeds better after an equal Crop, consisting of a bare competent Number of strong Plants, than after a Crop of thick weak ones, *ceteris paribus*.

Thus the hoed Crops, if well managed, consisting of fewer and stronger Plants than the sown Crops of equal Produce, exhaust the Ground less; whereby, and by the much (I had almost said infinitely) greater Pulveration of the Soil, indifferent good Land may, for any thing I have yet seen to the contrary, produce profitable Crops always without Manure, or Change of *Species*, if the Soil be proper for it in respect of Heat and Moisture; and also as Crops of some *Species*, by their living longer, by their
greater

All these Advantages will be lost by those Drillers, who do not overcome the unreasonable Prejudices of the unexperienced, concerning the Width of Intervals.

In wide Intervals, we can raise a good Crop with less Labour, less Seed, no Dung, no Fallow, but not without a competent Quantity of Earth, which is the least expensive of any thing given to Corn; the Earth of a whole good Acre being but about the Tenth Part of the common Expence; and of indifferent Land, a Twentieth; and such I count that of Five Shillings and Six-pence *per* Acre.

The Crop enjoys all the Earth; for betwixt the last Hoeing, and the Harvest, there remains nothing but Space empty of Mould in the Middle of the Intervals.

'Tis an Objection, that great Part of those wide Intervals must be lost (*u*), because the Wheat-roots do
not

greater Bulk, or different Constitution, exhaust more than others, respect ought to be had to the Degree of Richness of the Soil, that is to produce each *Species*; The Sowing and the Hoeing Husbandry differ so much both in Pulveration and Exhaustion, that no good Argument can be drawn from the former against the latter: But tho' a too great Number of Plants be, upon many Accounts, very injurious to the Crop, yet 'tis best to have a competent Number; which yet needs not be so exact, but that we may expect a great Crop from Twenty, Forty, or Fifty Plants in a Yard of the treble Row, if well managed.

(*u*) They do reach through all the Mould (as shall be proved by-and-by); and yet may leave sufficient Pasture behind; because it is impossible for them to come into Contact with all the Mould in One Year; no more than when Ten Horses are put into an Hundred Acres of good Pasture, their Mouths come into Contact with all the Grass to eat it in one Summer, though they will go all over it, as the Vine-roots go all over the Soil of a Vineyard without exhausting it all; because those Roots feed only such a bare competent Quantity of Plants, which do not overstock their Pasture.

The Superficies of the fibrous Roots of a proper Number of Wheat-plants bear a very small Proportion to the Superficies of the fine Parts of the pulverized Earth they feed on in these Intervals; for one cubical Foot of this Earth may, as is shewn in

nor reach it; but as we generally turn the Mould towards the Row at the last Hoeings, there is no Part
of

p. 29. have many thousand Feet of internal Superficie: But this is in proportion to the Degree of its Pulveration: and that Degree may be such as is sufficient to maintain a competent Number of Wheat-plants, without over-exhausting the vegetable Pasture, but not sufficient to maintain those, and a great Stock of Weeds besides, without over-exhausting it. And this was plainly seen in a Field of Wheat drilled on *Six-foot* Ridges, when the South Ends of some of the Ridges, and the North Ends of others, had their Partitions Hand hoed, and cleansed of Weeds, early in the Spring, the opposite Ends remaining full of a small *Species* of Weeds, called *Crow-needles*, which so exhausted the whole Intervals of the weedy Part of the Ridges, that the next Year the whole Field being drilled again with Wheat exactly in the Middle of the last Intervals, the following Crop very plainly distinguished how far each Ridge had its Partitions made clean of those small Weeds in the Spring, from the other End where the Weeds remained till full-grown; the Crop of the former was twice as good as that of the latter, even where both were cleansed of Weeds the next *Spring*. This Crop standing only upon that Part of the Mould, which was farthest from the Rows of the precedent Crop, proves that the Roots, both of the Wheat and Weeds, d.d enter all the Earth of the former Intervals.

It was also observable, that where the Partitions of Two of the Six-foot Ridges had been in the precedent Year cleansed of Weeds, and those of the adjoining Ridges on each Side of them not cleansed, the Row that was the next Year planted exactly in the Middle of the Interval between those two Ridges, was perceivably better than either of the Two Rows planted in the Intervals on the other Side of each of them: The Reason of which Difference must be, that the Middle of the Interval, that was between the Two cleansed Ridges, was fed on by the Wheat only, and by no Weeds; but the other Two Intervals were fed on by the Wheat on one Side, and by both the Wheat and Weeds on the other Side of each.

There were, in the same Field, several Ridges together, that had the Ends of their Rows of Wheat plowed out by the Hoe-plough, and their other Ends cleansed of Weeds: This was done on purpose, to see what Effect a Fallow would have on the next Crop, which was indeed extraordinary; for these fallowed Ends of the Ridges, being Horse-hoed in the Summer, as the other Ends were, and the Intervals of them made into Ridges, the following Year produced the largest Crop of all; this Crop was received in 1734.

These

of it above Two Feet distant from even the middle Row, and Seventeen Inches from either of the outside Rows.

And I have plainly proved, that the Roots of Cone-wheat have reached Mould at Two Feet Distance, after passing through another Row at a Foot Distance from it, the Plants being then but Eighteen Inches high, and but half-grown.

Farmers do not grudge to bestow Three or Four Pounds in the Buying and Carriage of Dung for an Acre; but think themselves undone, if they afford an extraordinary Eighteen-pennyworth of Earth to the wide Intervals of an Acre; not considering that Earth is not only the best, but also the cheapest Entertain-

These several different Managements performed in this Field, shewed by the different Success of the Crops in each Sort, what ought to be done, and which is the best Sort of Management.

This Field indeed is some of my best Land; and by all the Experiments I have seen on it, I do not find but that, by the best Management, never omitted in any Year, it might produce good annual Crops of Wheat always, without Assistance of Dung or Fallow; but it would be very difficult for me to get Hands to do this to the greatest Perfection, unless I were able constantly to attend them.

The whole pulverized Earth of the Interval being pretty equally fed on by the former Crop, 'tis no great Matter in what Part of it the following Crop is drill'd: I never drill it but on the Middle of the last Year's Interval, because there is the Trench whereon the next Year's Ridge is made with the greatest Conveniency: But there may be some Reason to suspect, that the Plants of the Rows exhaust more Hourishment from that Earth of the Intervals which is farthest from their Bodies, than from that which is nearest to them: Since their fibrous Roots, at the greatest Distance from the Rows, are most numerous, &c. by these the Plants, when they are at their greatest Bulk, are chiefly maintained.

It must be *noted*, that the above Experiments would not have been a full Proof, if Weeds had been suffered to grow in the Partitions of the Ends of those Ridges, in the Year wherein the Difference appeared. It may also be *noted*, that a Mixture and Variety of bad Husbandry are useful for a Discovery of the *Theory* and *Practice* of good Husbandry.

ment that can be given to Plants; for at Five Shillings and Six-pence Rent, the whole Earth belonging to each of our Rows costs only Six-pence, *i. e.* a Penny for a Foot broad, and Six hundred and Sixty Feet long; that being the Sixty-sixth Part of an Acre (*x*).

And if for constant annual Wheat-crops you make fewer than Eleven Rows on Four Perches Breadth, you will always increase the Expence of Hoeing; because then Two Furrows will not Hoe One of those Intervals, and you will also thereby lessen the Crops, but improve the Land more: And if you increase that Number of Rows, you will thereby increase every Expence; for there must be Two Furrows to hoe a narrow Interval, and an Increase of the Quantity of Seed, and the Labour in uncovering, weeding, and reaping; and also you will less improve the Land, and lessen the Crops after the First Year.

If the Intervals are narrower in deep Land, tho' there might be Mould enough in them, yet there would not be Room to pulverize it.

If narrower in shallow Land, tho' there were Room, yet there would not be Mould enough in them to be pulverized.

The Horse-hoe, well applied, doth supply the Use of Dung and Fallow; but it cannot supply the Use of Earth, tho' it can infinitely increase the vegetable Pasture of it, by pulverizing it, where it is in a reasonable Quantity: Yet if the Intervals be so narrow, that near all the Earth of them goes to make the Partitions raised at the Top of the Ridges, there will be so little to be pulverized, that you must return to Fallowing,

(*x*) But the Vulgar compute this Expence of a Foot Breadth of Ground, not only as of the Rent, as they ought, but as an Eleventh Part of their own usual Charges added to the Rent.

And there is Land enough in *England* to be had, at the Rent of Five Shillings and Six-pence the Acre, that is very proper for Wheat in the Hoeing-Husbandry.

and to the Dung-cart, and to all the old exorbitant Charges (y).

Eight Acres, Part of a Ground of Twenty Acres, drilled with Intervals of Three Feet and an half, brought a good Crop; but the Second Year, not being hoed, the Crop was poor; and the Third Crop made that Land so foul and turfy, that 'twas forced to lie for a Fallow, there being no way to bring it into Tilth without a Summer-plowing (z), when the rest of the same Piece, in wider Intervals, being constantly hoed, continued in good Tilth, and never failed to yield a good Crop, without missing one Year.

In another Field, there is now a Sixth Crop of Wheat, in wide Intervals, very promising, tho' this Ground has had no sort of Dung to any of these Crops, or in several Years before them: The last Year's Crop was the Fifth, and was the best of the Five, tho' a Yard of the Row yielded but Eighteen Ounces and Three Quarters; and the Third Crop yielded Twenty Ounces Weight (a) of clean Wheat
in

(y) The Objections against these wide Intervals are only for saving a Pennyworth or Two of Earth in each Row, or a few Groats-worth of it in an Acre; by saving of which Earth they may lose, in the present and succeeding Crops, more Pounds.

(z) This Narrowness of the Intervals, if the Damage of it be rightly computed, would amount to half the Inheritance of the Land; and was occasioned by the Wilfulness of my Bailiff, who, drilling it upon the Level, ordered the Horse to be guided half a Yard within the Mark, because he fancied the Intervals would be too wide, if he followed my Directions.

(a) Wheat, before Harvest, standing in Rows with wide Intervals betwixt them, may not seem, to the Eye, to equal a Crop of half the Bigness dispersed all over the Land, when sown in the common Manner; and yet there is more Deceit in the Appearance of those different Crops, whilst they are young, and in Grass: We should therefore not judge of them then by our Imagination, but as we do of the Sun and Moon nigh the Horizon, viz. by our Reason.

in the same Spot; but 'twas because the Spot where the Twenty grew, was then a little higher than the rest, which in Two Years became more equal; and the thin Land was more deficient in that Third Crop, than the thick Land exceeded the thin in the Fifth Crop.

In the thick the Hoe-plough went deeper, and consequently raised more Pasture there; but then it went the shallower in the thin; and when the Land became of a more equal Depth the Fifth Year, the Plough and the Hoe-plough went deeper, all the Piece being taken together; for the Crop could be but in proportion to the different Pasture, allowing somewhat for the more or less Seasonableness of the Year.

The Soil, in this our Case, cannot be supplied in Substance, but from the Atmosphere. The Earth which the Rain brings can do it alone, if it fall in great Quantity; for by Water, 'tis plain, the Earth which nourished *Helmont's* Tree was supplied; for the Tin-cover of the Box wherein it stood, prevented the Dews from entering.

Dews must add very much to the Land, thus continually tilled and hoed; for they are more heavily charged with terrestrial Matter than Rain is, which appears from their forcing a Descent through the Air, when 'tis strong enough to buoy up the Clouds from falling into Rain: And Dew, when kept in a Vessel long enough to putrefy, leaves a greater Quantity of black Matter at the Bottom of the

Imagination often deceives us by Arguments false or precarious; but Reason leads us to Demonstration, by Weights and Measures: Yet this Prejudice will vanish at Harvest before weighing; for then all those wide Intervals that were bare, will be covered with large Ears interfering to hide them quite, and make a finer Appearance than a sown Crop. But 'tis observed, that the Corn-wheat makes the finest Shew, when you look on it length ways of the Rows, both at Harvest, and a considerable time before Harvest.

Vessel,

Vessel, than Rain-water does in a Vessel of the same Bigness, filled with it till putrescied.

Dews at Land, I suppose, are first exhald from Rivers, and moist Lands, and from the Expirations of Vegetables; most of the Dew which falls on it is exhald from untilld Land; but most of that which falls on well tilld or well hoed Land, remains therein unexhald; so that the untilld Ground helps, by that means, to enrich and augment the tilld: For if an Acre be tilld for Two Years together without sowing, it will become richer by that Tillage, than by lying unplowd Four Years, which may be easily proved by Experience (*b*).

But then, as to Rain, the Sea being larger than all the Land (and its Waters, by their Motion, becoming replete with terrestrial Matter), 'tis not unlikely, that more Vapour is raised from One Acre of Sea, than from One hundred Acres of Land.

Some have been so curious as to compute the Quantity of Rain, that falls yearly in some Places in *England*, by a Contrivance of a Vessel to receive it; and 'tis found, in one of the driest Places, far from the Sea, to be Fourteen Inches deep, in the Compass of a Year; in some Places much more; *viz.* at *Paris*, Nineteen Inches; in *Lancashire*, Mr. *Townley* found, by a long-continued Series of Observations, that there falls above Forty Inches of Water in a Year's time.

Could we as easily compute the true Quantity of Earth in Rain-water, as the Quantity of Water is computed, we might perhaps find it to answer the Quantity of Earth taken off from our hoed Soil annually by the Wheat.

But if Land sown with Wheat be not hoed, its Surface is soon incrustate; and then much of this Water, with its Contents, runs off, and returns to

(*b*) *Non igitur Fatigatione, quemadmodum plurimi crediderunt, nec Senio, sed nostra scilicet Inertia, minus benigne nobis Arva respiciunt.* Colum. lib. xi. cap. 1.

the Sea, without entering the Ground; and in Summer a great deal of what remains is exhaled by the Sun, and raised by the Wind, both in Summer and Winter.

Some there are who think it a fatal Objection, that the more an Interval is hoed, the more Weeds will grow in it; and that the Hoe can produce, or (as they say) breed in it as many Weeds in one Summer, as would have come thereon in Ten Years by the old Husbandry. But by this Objection they only maintain, that the Hoe can destroy as many Weeds in One Summer, as the old Husbandry can in Ten Years.

And they might add, that since all Weeds that grow where the Hoe comes, are killed before they feed, and that few of those which grow in the old Husbandry, are killed (c) before their Seed be ripe and shed; these Objectors will be forced to allow, that our Husbandry will lessen a Stock of Weeds more in one Summer, than theirs can do to the World's End; unless they believe the equivocal Generation of Weeds, than which Opinion nothing can be more absurd.

Some object against my Method of (d) weighing a Yard, or a Perch in Length of a Row, saying, this does not determine the Produce of a whole Field.

I an-

(c) Weeds cannot be killed before they grow, but will lie dormant, as they do in our Partitions, and in their sown Land; and while Seeds are in the Ground, they are always ready to grow at the first Opportunity, and will certainly break out at one time or other; so that preventing their coming, is only like healing up a Wound before it be cured.

(d) I did not weigh this Yard, as different from the other Yards round about it, for I had much Difficulty to determine which Row I should chuse it in; when I was going to cut in one Row, it still seemed that another was better, and I question whether I did chuse the best at last.

Note, Whereas I often mention the Wheat of this Field to be without Dung or Fallow, it must be understood of that Part of the Field wherein my *Weighings* and other Trials were made:

I answer, that they judge right, if the Produce of the whole Field be not of equal Goodness; but if it be not, it must be because one Part of the Field is richer, or differently managed from the other Part: For the same Causes that produce Twenty Ounces of clean Wheat upon one Yard, must produce the same Quantity upon every Yard, of a Million of Acres.

When the Crop of half a Field is spoiled by Sheep, not hoed at all, or improperly, it would be ridiculous to compute the whole Field together for an Experiment: We might indeed weigh the poorest, to prove the Difference of the one from the other, to try (as they sometimes seem to do) how poor a Crop we can raise; but my Design was, to try how good a Crop I could raise with a Tenth Part of the common Expence.

And I have often weighed the Produce of the same Quantity of Ground (*e*), of all Sorts of sown Wheat, both the best and the worst; but never have found any of the sown equal to the best of my drilled. Indeed we have none of the richest Land (*f*) in our

because there was a small Part once fallowed Eight or Nine Years ago, and a little Dung laid on another Part about the last *Michaelmas*, after the Crop of Oats was taken off. But this being a Year in which Dung is observed to have little or no Effect on *sown* Wheat (my Dung being weak and laid thin), 'tis the same here; for those Rows which are in the dunged Part, can hardly be distinguished from the rest of the Rows which had not been dunged: And yet the Ends of the Rows which were cleaned of Weeds, are very distinguishable by the Colour of the Wheat, though some are the Third, and some the Fourth Crop since the Difference was made; and the *whole* Rows managed alike every Year, from that time to this; so that *here* Un-exhaustion is more effectual than Dung. This is certain, that neither Dung nor Fallow hath been near the Part wherein my Experiments were made.

(*e*) I allow Two square Yards of their Crops to One Yard in Length of my Treble Row.

(*f*) I am sorry that this Farm, whereon I have practised Horse-hoeing, being situate on an Hill, that consists of Chalk on one Side, and Heath ground on the other, has been usually noted for the poorest and shallowest Soil in the Neighbourhood.

Country

Country within my Reach, that being not above One Mile.

As a Yard in Length of my treble Row of the Third successive Crop of Wheat, without Dung or Fallow, produced Twenty Ounces of Wheat; which, allowing Six Feet to the Ridge, is about Six Quarters (*a*) to an Acre; and, allowing Seven Inches to each Partition, and Two Inches on each Outside, is in all Eighteen Inches of Ground to each treble Row, and but just One-fourth Part of the Ridge. Now, if, in the old Husbandry, the Crop was as good all over the Ground, as it was in these Eighteen Inches of the treble Row, they must have Twenty-four Quarters to an Acre; but let them dung whilst they can, they will scarce raise Twenty-four Gallons of Wheat the Third Year, on an Acre of Land of equal Goodness; and let them leave out their Dung, and add no more Tillage in lieu of it, and I believe they will not expect Three Quarters to an Acre, in all the Three Years put together.

The mean Price of Wheat, betwixt Dear and Cheap, is reckoned Five Shillings a Bushel (*b*); and there-

(*a*) Eight Bushels make a Quarter.

(*b*) 'Tis commonly said, that a Farmer cannot thrive, who for want of Money is obliged to sell his Wheat under Five Shillings a Bushel; but if he will sell it dear, he must keep it when 'tis cheap: And his Way of keeping it is in the Straw, using his best Contrivances to preserve it from the Mice.

The most secure Way of keeping a great Quantity of Wheat, that ever I heard of, is by drying it. When I lived in *Oxfordshire*, one of my nearest Neighbours was very expert in this, having practised it for great Part of his Life: When Wheat was under Three Shillings a Bushel, he bought in the Markets as much of the middle Sort of Wheat as his Money would reach to purchase: He has often told me, that his Method was to dry it upon an Hair-cloth, in a Malt-kiln, with no other Fuel than clean Wheat-Straw; never suffering it to have any stronger Heat than that of the Sun. The longest time he ever let it remain in this Heat was Twelve Hours, and the shortest time about Four Hours; the damper the Wheat was, and the longer intended to be kept,

therefore an Acre that would produce every Year, without any Expence, Eight Bushels, would be thought

the more Drying it requires: But how to distinguish nicely the Degrees of Dampness, and the Number of Hours proper for its Continuance upon the Kiln, he said was an Art impossible to be learned by any other Means than by Practice. About Three or Four and Twenty Years ago, Wheat being at Twelve Shillings a Bushel, he had in his Granaries, as I was informed, Five thousand Quarters of dried Wheat; none of which cost him above Three Shillings a Bushel.

This dried Wheat was esteemed by the *London* Bakers to work better than any new Wheat that the Markets afforded. His Speculation, which put him upon this Project, was, that 'twas only the superfluous Moisture of the Grain that caused its Corruption, and made it liable to be eaten by the Weevil; and that when this Moisture was dried out, it might be kept sweet and good for many Years; and that the Effect of all Heat of the same Degree was the same, whether of the Straw, or of the Sun.

As a Proof, he would shew, that every Grain of his Wheat would grow after being kept Seven Years.

He was a most sincere honest Yeoman, who from a small Substance he began with, left behind him about Forty thousand Pounds; the greatest Part whereof was acquired by this Drying Method.

For the Hand-hoeing they use Hoes of Four Inches Breadth, very thin, and well steeled: Their Thinness keeps them from wearing to a thick Edge, and prevents the Necessity of often grinding them. Such Hoes are in Use with some Gardeners near *London*. They need not be afraid of drawing these little Hoes across the Rows of young Wheat to take out the few Weeds that come therein at the early hoeing; for whilst the Wheat-plants are small, it may be an Advantage to cut out some of the weakest, as they do of Turneps; for I perceive there are oftener too many Plants than too few. But the thing that causes the greatest Trouble in cleansing the Rows, is when the Seed is foul (*i. e.* full of Seeds of Weeds): Therefore I cleanse my Seed-wheat by drawing it on a Cloth on a Table, which makes it perfectly clean.

This Hand-hoeing should be performed about the End of *March*, or Beginning of *April*, before the Wheat is spindled (*i. e.* run up to Stalks); and if the Weather be dry enough, you may go lengthways of the Ridges with a very light Roller to break the Clods of the Partitions, whereby the Hoe will work the better.

If there should afterwards more Weeds come up, they must not be suffered to ripen; and then the Soil will be every Year freer from Weeds.

thought an extraordinary profitable Acre; but yet a drilled Acre, that produces Sixteen Bushels of Wheat,

This Hand-hoeing of the Rows should be done at the proper time, though it happen, by late Planting, that the Horse-hoe has not gone before it; for it may be, that the Weather has kept out the Horse hoe: and the Earth may not be dry deep enough in the Intervals for the Hoe-plough, but deep enough in the Partitions for the Hand-hoe.

And the Expence of this Hand-work on the Rows would be well answered, though there should not be one Weed in them; and so it would be, if a second Hand hoeing were bestowed on the Partitions of every Crop of Wheat not suspected of being too luxuriant.

If after the last Horse-hoeing there should be Occasion for another Hoeing of the Intervals, where the Narrowness of them, and the Leaning of tall Wheat, make it difficult or dangerous to be performed by the Hoe-plough; a slight shallow Hoeing may be performed therein by the Hand-hoe with Ease and Safety, at a very small Expence, which would be more than doubly repaid in the following Crops.

IF any one doubts of the Efficacy of thus managing Wheat, it can't cost much to make proper Trials. But then Care must be taken, that the Trials be proper. I do not advise any one to be at the Expence of my Instruments for that Purpose, but to imitate them in pulverizing, and all other directed Operations by the Spade and common Hoes. His Ridges of Experiment need be no longer than Six Feet. Instead of a Drill, make use of a triangular Piece of Wood, Seven Feet long, and Four or Five Inches thick, with one Edge of which make Channels, and place the Seed regularly even into them by Hand, and cover it with the same Piece of Wood; but if the Earth be so wet, as to cling to the Piece, then make use of it only as a Ruler, whereby to make the Channels strait with a Stick.

Let some of the Ridges have double Rows, others treble; and let some have treble Rows half-way, and leave out the middle Row in the other Half, to shew whether the double Row or the treble Row produce a better Crop.

Then for the first time of Hoeing, the Spade must work with its Back towards the Row. The second time, in turning the Earth to the Row, the Spade's Face must be towards it. These Two, and several other Hoeings should be deep; but when the Roots are large (and the Hoeing is near the Plants), the Spade must go shallow; and neither the Face nor the Back of it must

Wheat, with the Expence of Ten or Fifteen Shillings, is above a Third Part more profitable.

I don't

be towards the Row, except when the Earth is turned towards it; and then the Face must be always towards it; but for the rest of the last Hoeings, the Spade should work with its Face towards one or other of the Ends of the Intervals, that the fewer of the Roots may be cut off, and the more of them removed, and covered again. Let the Spits be thin for the better pulverizing of the Mould. The Hand-hoe will sometimes be useful in the Intervals, as well as in the Partitions.

Four or Five Perches of Land may suffice for making proper Trials.

The Expence of this will be little, though perhaps Ten times more than that which is done by the proper Instruments for the same Proportion of Land.

But I must give this Caution, that no Part of it be done out of the Reach of the Master's Eye; for if it should, he may expect to be disappointed.

The richer the Land, the thinner it must be planted to prevent the lodging of Corn.

The Master ought to compute the Quantity of Seed, due to each Perch, at the Rate of Five or Six Gallons to an Acre, by Weighing, &c. as I have shewn in my Essay.

I cannot commend more than Two Partitions in a Row, or more than One, when the Intervals are narrow; because the broader the Row is, the more Earth will remain unpulverized, under the Partitions; too much of which Earth being whole, will disappoint, at least, one of the Differences mentioned in my sixth Chapter.

Indifferent Land I think most proper whereon to make the Experiment, and the most improper for Corn is barren Land, as the best brings the largest Crops.

To ascertain the Quantity of the Crop, take a Yard in the Middle of a Ridge, and weigh its Produce.

Every Year leave one Interval unhoed, to prove the Difference of that Side of a double or treble Row next to it, from the other Side next to the hoed Interval.

But it must be noted, that the Spade doth not always pulverize so much as the Plough, or Hoe plough; therefore there may be occasion for more Digging, than there would be of Horse-hoeings.

One of the Observations that put me upon Trials of wide Intervals, and Horse work for Corn, was the following; *viz.* One Half of a poorish Field was sown with Barley; the other Half drilled with Turneps, the Rows Thirty Inches asunder, at the proper Season, and twice hoed with a Sort of Horse-hoe contrived

trived for that Purpose (but nothing like that I have described); the Drill, beginning next to the Barley, left an Interval of the same (30 Inches) Breadth between the First Row of Turneps and the Barley, which, being sown on large Furrows, came up in a sort of Rows, as is common for Barley to come when sown on such wide Furrows. This Interval between the Barley and the Turneps had the same Hoings as the rest, and had this Effect on the broad Row of Barley next to it; *viz.* Each Plant had many Stalks; it was of a very deep flourishing Colour, grew high, the Ears very long, and, in all respects, the Barley was as good as if it had been produced by the richest Land. The next Row of Barley had some little Benefit on the Side next to the strong Row; but all the rest of the Barley, either by the too late Sowing of it, the Poverty of the Soil (not being in any manner dunged), or else by the Coldness of the Land, or Coldness of the Summer, or by all of these Causes, though pretty free from Weeds, was exceeding poor, yellow, low, thin, and the Ears were very short and small.

I intended to have taken the exact Difference there was between the Produce of this outside Row, and one of those that stood out of the Reach of the hoed Interval: But I was disappointed by my Neighbour's Herd of Cows, that in the Night broke in just before Harvest, and eat off almost all the Ears of the rich Row, doing very little Damage to the rest, except by treading it. It must be from the different Tastes, the one being sweet, and the other bitter, that they make their Election to eat the one, and refuse the other.

This accidental Observation was sufficient to demonstrate the Efficacy of deep Hoing, which I look upon as synonymous to Horse-hoing.

I immediately set about contriving my limbered Hoe, finding all other Sorts insufficient for the Exactness required in this hoeing Operation: Those drawn in any other manner, when they went too far from the Row, and the Holder went to lift the Plough nearer, it would fly back again, like the Sally of a Bell, and go at no Certainty not being subject to the Guidance of the Holder, as the limber Hoe-plough is. The *Mickelmas* following I began my present Horse-hoing Scheme; which has never yet deceived my Expectations, when performed according to the Directions I have given my Readers. And the Practice of this Scheme proves the Advantage of deep Hoing, by the Ends of the Ridges and Intervals; for there, whilst the drawing Cattle go on the Head-land that is higher, the Furrows are shallower, and the Corn of the Rows is always there visibly poorer in proportion to that Shallowness.

Another Proof of the Difference there is between deep Hoing and shallow, is in the Garden, where a square Perch of Cabbages, the Rows of which are Three Feet asunder; the middle Row of

them having the Intervals on each Side of it deeply and well dug by the Spade at the same proper time, when the rest of the Intervals are Hand hoed; this middle Row will shew the Difference of those Two Operations: But in this must be observed what I have here before mentioned, of turning the Back of the Spade to the Plants, to avoid the total removing them, especially in very dry Weather.

This Experiment hath been tried, and always succeeds with every one that has made the Trials.

But before any one makes his Trials of my Field-scheme, I would advise him to be Master of the Treatise, by making an *Index* himself to it: This will both direct him in his Proceedings, and shew him the Rashness of those, who go into the Practice of my Husbandry, without the necessary Preparation; for they that do so now, seem to act as rashly, as they that went into it before the Treatise was published. 'Tis reasonable to presume, that such their Practice must be either different from, or contrary to mine.

This *Index* may be also useful for discovering Pretenders by an Examination, without which, Gentlemen are liable to be imposed on by them, as I am afraid too many have been; for amongst all those who have undertaken the Management of my Scheme for Noblemen, or others, I declare I do not know one Person that sufficiently understands it: There may be some who have seen, or perhaps performed, some of the mechanical Part; but I don't think it can be properly performed without a thorough Knowledge of the Principles, which cannot be expected of such illiterate Persons; and yet is necessary for the proper Applications in different Cases, which cannot be distinguished by Pretenders: Therefore, until the Scheme becomes common, the Management must be under the Direction of the Master himself, or of one who has pass his Examination, and is faithful.

To the above Trials, I here add the following, together with some Alterations of the former.

Gentlemen who can get the *Smyrna* Wheat, I advise to make Trials of it in single Rows, of between 17 and 18 to an Acre, in this Method; there being no Partitions, the Intervals will be of the same Width as in the Ridges of 14 to an Acre, that have Partitions of Ten Inches. Thus almost all the Earth of the Ridges may be pulverized by the Hoe-plough in the Field, or by the Spade in this Trial; and very little Hand-work will be necessary for cleansing out the Weeds that come in the Rows, and on each side of them. The J and will be the fitter for a succeeding Crop of Wheat with less Harrowing. But this must be observed, that, in regard to hard Frosts in Winter, and very dry Weather in Summer, the alternate Hoeing described in the Chapter of Turneps may be proper; lest the little Earth that may be left for the Row to stand on, when the Furrows are turned from both Sides

of it, should not be sufficient to secure the Roots from the Injuries that may happen to them by being exposed either to Frost or Drought on both Sides of the Row at the same time.

In the Field, when the Ridges are all of an equal Breadth, the best Way is to plant Two of the single Rows at once, by setting the Two Beams of the Drill at the same Distance asunder, as each of the Ridges is broad; and the Beast that draws it must go in the Middle of the Interval, planting a Row on each Side of it; but if the Ridges are very unequal, the Beast (a little Horse is best) that draws the Drill must go on the Top of a Ridge, planting one Row thereon; and the Drill for this Purpose is the same as the Turnep-drill, except that the Beam-share, Seed-box, and Spindle, are the same as those of the Wheat-drill; and 'tis but to take off from the Wheat-drill one of its Beams, and place it in the room of the Beam of the Turnep-drill, and placing the Cross-piece of the Turnep-beam (see Plate 5.) on this Beam, and also a short Wheat-hopper to be drawn by the Turnep-standards, setting the Wheels near enough together; *i. e.* as near as the Wheels of the Wheat-drill are, I mean those which plant Two Rows.

Two Gallons of *Smyrna* Wheat I judge will be Seed sufficient for an Acre, especially if planted early.

Planting one Row upon a Ridge, I think is the most advantageous Method of all; but, not being able to get any *Smyrna* Wheat (tho' I have been often promised it), I have made no Trial of it; and I do not believe the Plants of any other Sort of Wheat are large enough for such single Rows.

I am not quite a Stranger to this Wheat; for I have seen the Product of it, both in the Garden, and in the Field, above Forty Years ago.

I am now making Trials, in order to know how much a single Row of White cone Wheat will exceed half a double one: For this Purpose, I cause one Row of the double, with the Partition, to be dug out with a Spade, in Part of every Field, Two or Three Yards in a Place: These I intend shall be hoed as the double Rows are; and where the Hoe-plough doth not reach, the Spade shall supply its Use.

I do not expect this single Row will equal the double Row; but I am in no doubt but that it will produce more Grain than half a double Row.

I cannot tell whether the Sort of Cone-wheat that sends out little Branches on each Side of the Ear, might not succeed tolerably well in single Rows; for its Ear is, when well nourished, larger than the Ear of the White-cone; tho' not near so large as that of the *Smyrna*.

Another Experiment I propose to be made as a Trial for the Satisfaction of such sceptical Gentlemen who may doubt the Truth

I don't know that I ever had an Acre yet, that was tolerably well managed in this Manner, but what produced much more.

C H A P.

Truth of what I have related in p. 27, 28. concerning the wonderful Effect of deep Hoeing. In a Field of very poor old decayed St. Foin, let Two or Three Perches be hedged in, in a square Piece, and Two, Three, or more Intervals, of Three or Four Feet wide each, be well pulverized by the Spade, leaving between every Two of them, Two or Three Feet of the St. Foin unmoved. Begin this Work in Summer, and repeat the Hoeing pretty often, observing the Rules I have laid down for Hoeing the Intervals of Wheat. Let not the Back of the Spade be turned towards the unmoved St. Foin, from which it throws the Earth at the First time of Hoeing; which is contrary to the First Hoeing of Wheat with a Spade; because there would otherwise be Danger of moving Wheat-roots; but there is no Danger of moving the St. Foin Roots, unless you wholly dig them out: Therefore the best Way for this Hoeing is to dig with the Back of the Spade towards one or the other End of the Interval: This cuts off the fewest Roots, and covers the most of them, and may perhaps be sometimes best for Wheat also. When the Earth is turned towards the St. Foin Rows, the Spade's Face will be towards them of course.

Be sure to leave Four or more Feet untouched next to the Hedge that bounds the Piece, to the End that the Increase of the hoed St. Foin may the more plainly appear by comparing its Plants with those that are not hoed.

If the Plants are very thick, make them thinner on one side of an Interval; and, on the other side, let them remain thick. You will certainly find the thin Plants most wonderfully increased in a Year or two, and the thick ones in proportion; and also the natural Grass, and all other Vegetables that grow near to the Intervals when they are well pulverized. I am confident mine, thus managed by Ploughs, increased some to an Hundred, some to a Thousand times the Size they were of before that Pulveration.

All the Methods I have here and elsewhere described for the Field, I advise to be tried in these few Perches for Experiments.

I think some of those Ridges whereon one End is to be managed differently from the other End, should be longer than Six Feet; else the Roots of the Wheat and Weeds may so mix, and draw Nourishment from one another in the Middle of the Ridge, that the Difference of the Managements may not so plainly be seen as when the Ridge is longer.

The few Perches of Land whereon any of the proposed Experiments are to be made, should be bounded in with dead Hedges;
and

C H A P. X.

Of SMUTTINESS.

SMUTTINESS is when the Grains of Wheat instead of Flour, are full of a black, stinking Powder: 'Tis a Disease of Wheat, which I don't know is usual any-where but in cold Northern Countries; for if it had been common in *Greece* or *Italy*, there would probably have been some Word to express it by, in those Languages, as well as there is for the Blight.

I take it to be caused by cold wet Summers; and I was confirmed in this by several Plants of Wheat, taken up when they were in Grass in the Spring, and placed in Troughs in my Chamber-window, with some of the Roots in Water. These Wheat-plants sent up several Ears each; but at Harvest, every Grain was smutty; and I observed, none of the Ears ever sent out any Blossom: This Smuttiness could not be from any Moisture that descended upon it, but from the Earth, which always kept very moist, as in the aforesaid Mint Experiment. The Wheat-plants in the Field, from whence these were taken, brought very few smutty Grains, but brought much larger Ears than these.

Whatsoever the Cause (*d*) be, there are but Two Remedies proposed; and those are Brining, and Change of Seed.

Brining of Wheat, to cure or prevent Smuttiness (as I have been credibly informed), was accidentally

and should not be situate within Three or Four Poles of a live Hedge or Tree.

The Three Instruments to be used in these unexpensive Trials, are, the Spade, to supply the Use of the Plough and Hoe plough; the Hand-hoe; and a Rake, instead of Harrows.

(*d*) The largest grained, plump, fat Wheat, is more liable to Smuttiness, than small-grained thin Wheat.

discovered about Seventy Years ago, in the following Manner; *viz.* A Ship-load of Wheat was sunk near *Bristol* in Autumn, and afterwards at Ebbs all taken up, after it had been soaked in Sea-water; but it being unfit for making of Bread, a Farmer sowed some of it in a Field; and when it was found to grow very well, the whole Cargo was bought at a low Price by many Farmers, and all of it sown in different Places. At the following Harvest, all the Wheat in *England* happened to be smutty, except the Produce of this brined Seed, and that was all clean from Smuttiness. This Accident has been sufficient to justify the Practice of Brining ever since in all the adjacent Parts, and in most Places in *England*.

I knew Two Farmers, whose Farms lay intermixed; they bought the same Seed together, from a very good Change of Land, and parted every Load betwixt them in the Field. The oldest Farmer believed Brining to be but a Fancy, and sowed his Seed unbrined; the other brined all his Part of Seed, and had not a smutty Ear in his Crop; but the old Farmer's Crop was very smutty.

Wheat for Drilling must have no other Brine, than what is made of pure Salt; for if there be any Brine of Meat amongst it (*e*), the Grease will not suffer the Wheat to be dry enough to be drilled.

If Seed-wheat be soaked in Urine, it will not grow; or if only sprinkled with it, it will most of it die, unless planted presently.

The most expeditious Way of brining Wheat for the Drill, is to make a very strong Brine; and when the Wheat is laid on an Heap, sprinkle or lave it therewith; then turn it with a Shovel, and lave on more Brine; turn it again with a Shovel, until, by many Repetitions of this, the Wheat be all equally

(*e*) Urine also makes the Wheat so greasy, that it will not be dry time enough to be drilled.

wet. Next, sift on Quick-lime through a Sieve; turn the Wheat with a Shovel, and sift on more Lime; repeat this Sifting and Turning many times, which will make it dry enough to be drilled immediately; and this has been found sufficient to preserve uninfected Wheat from the Smut in a bad Year, the Seed being changed.

To dry it, we use (*f*) Quick-lime (that is, un-slacked), which, beaten to Powder, and sifted thereon, confines the Brine to the Surfaces of the Grains, and suffers none of it to be exhaled by the Air: But when Lime has been long slacked, and is grown weak, 'tis unfit for this Purpose.

Smutty Seed-wheat, tho' brined, will produce a smutty Crop, unless the Year prove very favourable.

For 'tis to be known, that favourable Years will cure the Smut, as unkind ones will cause it: Else, before Brining was used, and the bad Years had caused all the Wheat in *England* to be smutty, they must have brought their Seed from Foreign Countries, or never have had any clean Wheat: Therefore 'tis certain, that kind Years will cure the Smut: 'Tis therefore to prevent the Injury of a bad Year, that we plant clean Seed, and well brined.

But of the Two Remedies against Smuttiness, a proper Change of Seed some think the most certain.

A very worthy Gentleman assures me, that since he has found out a Place that affords a Change of Seed proper to his Land, which is for these Ten

(*f*) But if this doth not afford Powder enough, the Pieces must be slacked immediately before using; for if the Lime lie long after it is slacked (especially that made of Chalk), it will become weak, and lose most of its drying Quality.

Some Farmers use only to boil the strongest Quick-lime in Water, with which, instead of Brine, they sprinkle their Wheat, affirming it to be as effectual as that for preventing the Smut: But this not being within the Compass of my own Experience, I am doubtful of it; yet I wish it may be found effectual, because it would save Trouble to the sower, and more to the Driller.

Years

Years past, he never had a Smutty Ear in any of his Crops (and he never brines nor limes it), tho' all other Wheat have been often smutty throughout his Neighbourhood every wet Year, tho' brined and limed. He says, the Person who furnishes him with this Seed, is very curious in changing his Seed also every Year.

This gives a Suspicion, that our drowned Wheat at *Bristol* might possibly be Foreign; and then might not have been smutty the next Year, tho' it had not been soaked in the Sea-water.

The Wheat sown by the Two Farmers aforementioned might be from a good Change of Land, but the Seed not changed the precedent Year; and then it might be no more infected, than what the Brine and Lime did cure.

To know what Changes are best to prevent Smuttiness of Wheat, we must consult the most Experienced; and they tell us, that the strong Clay Land is best to be sent to for Seed-wheat, whatever Sort of Land it be to be sowed upon; a White-clay is a good Change for a Red-clay, and a Red for a White. That from any strong Land is better than from a light Land; and the old Rhyme is, that Sand is a Change for no Land. But from whatever Land the Seed be taken, if it was not changed the preceding Year, it may possibly be infected; and then there may be Danger, tho' we have it immediately from never so proper a Soil.

The strongest Objection that has been yet made against constant annual Crops of Wheat, is, that those Grains of the precedent Crop which happen to shed, and grow in the following Crop, will be in Danger of Smuttiness, for want of changing those individual Seeds.

All I can say in Answer is, that during these Five Years, which is all the time I have had these annual Crops, this objected Inconvenience never has happened

pened to me, even when a precedent Crop has been smutty.

The Reason I take to be, that a Crop very early planted is not so apt to be smutty; and if it be not planted early, the Grains that are shed grow, and are killed before, or at the time of planting the next Crop. This saves a Crop following a smutty one (which is always occasioned by bad Seed, or bad Ordering); and when the former Crop was planted with good Seed well ordered, the shattered Grains of that may produce clean Wheat the Second Year; and 'tis very unlikely, that any Breed of these Grains should remain to grow in the Crop the Third Year.

C H A P. XI.

Of BLIGHT.

WHEAT is blighted at Two Seasons; First, when in the Blossom; and then its Generation is prevented and many of the Husks are empty in the Ear, the Grains not being impregnated.

Secondly, Wheat is blighted, when the Grains are brought to the time of their Maturity, but are light, and of little Value for making of Bread; because they are not well filled with Flour.

The First cannot happen in *England* by the Frost because the Winters do not suffer it to grow so much, as to come into Blossom before the Month of *June*; but they are long continual Rains that rot or chill the Blossoms, and prevent their Fertility. Yet this is what seldom happens to any great Degree. Wheat that grows in open Fields has some Advantage from the Wind, that dislodges the Water sooner

sooner from the Ears, than it can do in sheltry Places; and Lammas Wheat does not hold the Drops of Rain so long as the Bearded (or Cone) Wheat, which received very great Damage by this sort of Blight in the Year 1725, the like never having been heard of before.

The Second sort of Blight, *viz.* from light Ears, is that which is most frequent, and more general: This brings the greatest Scarcity of Wheat. The Cause is plainly Want of Nourishment to perfect the Grain, by whatever means that Want is occasioned.

Several Accidents kill the Plants, or injure their Health, and then the Grains are not filled; as Lightning, the Effects whereof may be observed by the blackish Spots and Patches in Fields of Wheat, especially in such Years as have more of it than usual. Against this there is no Defence.

The other Causes of the Blight, which are most general, and do the most Damage, may, in some measure, be prevented.

One Cause is the lodging or falling of Corn; for then the Stalks are broken near the Ground, whereby many of the Vessels are so pressed, that the Juices cannot pass them; and then the free Circulation is hindered; the Chyle cannot mount in sufficient Quantity to be purified, and turned into Sap; the Defect whereof makes the Plants become languid, and only just able to live; they have Strength enough to linger on to the time of their Period, as in very old Age, but not to bring their Fruit, which is the Grain, to its natural Bulk, nor to fill it with Flour: and the sooner the Stalks fall, the less and thinner the Grain will be.

Hence it often happens, that when Tillage, Dung, and good Land have brought a Crop of Wheat, that in the Months of *April* and *May* promise to yield the Owner Five or Six Quarters on an Acre, then in *June* it falls down, and scarce
affords

affords Five or Six Bushels ; and that perhaps is so thin and lank, that the Expence of reaping and threshing it may overbalance its Value.

That the falling down of Wheat does cause the Ruin of the Crop, is well known ; but what causes it to fall, is not so plain.

And, without knowing the true Causes, 'tis not likely that a Remedy should be found against the Disease.

I take this Weakness of the Stalks, which occasions their falling, to proceed from want of Nourishment, want of Air, want of the Sun's Rays, or of all Three.

One Argument, that it lodges for want of Nourishment, is, that a rich Acre has maintain'd a Crop of Five Quarters standing, when another poorer Acre was not able to support a Crop from falling, which was but large enough to have brought Three Quarters, if it had stood : and this in the same Year, and on the same Situation. And 'tis very plain, that if one Acre was twice as rich as the other, it must be able to nourish Five Quarters better than the other could nourish Three Quarters.

Air is necessary to the Life and Health of all Plants, tho' in very different Degrees : Aquatics, which live under Water, are content with as little Air, as their Companions the Fishes.

But Wheat, being a terrestrial Plant, (tho' in Winter it will live many Days under Water, whilst the slow Motion of its Sap gives it little or no Increase), requires a free open Air, and does not succeed so well in low sheltery Places, as upon higher and opener Situations ; where the Air has has a greater Motion, and can more easily carry off the Recrements from the Leaves, after it has shaken off the Dews and Rains, which would otherwise suffocate the Plants ; and therefore the Leaves are made so susceptible of Motion from the Air, which frees them from

the Dews, that would stop in the Recrements at the *Vesiculæ* of the Leaves, but shaken down will nourish the Plants at the Roots: The want of this Motion weakening the Wheat, 'tis (as Animals in the like sickly Case are) the more unable to stand, and the more liable to be press'd down by the Weight of Rain-water, and more unable to rise up again when down: All which Evils are remov'd by the free Motion of the Air, which shakes off both Dews and Rains, and thus contributes to prevent the falling (or lodging) of Wheat.

A great Quantity also of the Sun's Rays is necessary to keep Wheat strong, and in Health; and in *Egypt*, and other hot Countries, it is not so apt to fall, as it is when sown in Northern Climates, tho' the Produce of the South be the greatest (a).

It may be observ'd, that every Leaf is inserted into a Sort of Knot, which probably delivers the Sap to be depurated at the *Vesiculæ* of the Leaves, and then receives it back again for the Nourishment of the Plant, doing for that Purpose the Office of an Heart: But the Sun with his Rays supplies the Part of Pulse, to keep the Sap in Motion, and carry on its Circulation, instead of the Heart's *Systole* and *Diastole*. Wheat, being doubtless originally a Native of a hot Country, requires by its Constitution a considerable Degree of Heat to bring it to Perfection; and if much of that Degree be wanting, the Wheat will be the weaker; and when the Solar Rays cannot reach the lower Parts of the Stalks, the lowest Leaves and Knots cannot do their Office; for which Reason the Chyle must mount higher before it be made into Sap, and there must be then a greater Mixture of crude Chyle next to the Ground, as by the white

(a) This proves that the Crop doth not lodge on account of its Bigness.

Colour it appears (*b*). By this Means that Part, which, if it had a due Share of the Sun's Influence, would be harden'd like a Bone or Spring, for the Support of the Stalks, for lack of that, becomes more like to a Cartilage, soft and weak, unable to sustain the Weight of the bending Ear, which, having its greatest *Impetus* against this Part, which is most feeble to resist it, it yields, and lets it fall to the Ground; and then the Grain will be blighted.

There is also another Cause of the Blight; and that is, the Wheat's coming too late into Blossom. The usual Time is the Beginning of *June*; and if it be later, the Days shorten so fast after the Solstice, that the Autumn of the Year hastening the Autumn of the Wheat's Life, the full Time of its Pregnancy (*c*) is not accomplish'd; and then its Fruit, which is the Grain, becomes as it were abortive, and not full-grown. This Time betwixt the Generation, Blossoming, and the Maturity of the Grain, is, or ought to be, about Two Months.

Therefore 'tis advantageous to hasten, what we can, the Time of Blossoming, and to protract the Time of

(*b*) But now I suspect this to be a Mistake, it being more likely, that the white Colour of the Rind is owing to the Absence of the Sun and free Air, than to the Chyle, as the Skin of those Parts of our own Bodies that are concealed from them, is whiter than of those which are exposed to them, though no Chyle-vessel comes near our Skin.

(*c*) *Ut enim Mulieres habent ad Partum Dies certos, sic Arbores ac Fruges.* Varro, *Lib. 1. Cap. 44.*

Mense Maio florent; sic Frumenta, & Ordecum, & quæ sunt Seminis singularis, Octo diebus floreant, & deinde per Dies 40. grandescunt Flore deposito usque ad Maturitatis Eventum. Palladius, *Pag. 114, 115.*

Quindecim Diebus esse in Vaginis, Quindecim florere, Quindecim exarescere, cum sit maturum Frumentum. Varro, *Lib. 1. Cap. 32.*

But the different Heat that there is in different Climates, may alter both the Time that Plants continue in Blossom, and the Time betwixt the Blossoming and the Ripening.

Ripening: And 'tis observ'd, that the earliest sown Wheat generally escapes the Blight the best, because it comes first into Blossom.

Feeding down the Wheat with Sheep prevents the Blight, by doing what the Blight wou'd do, if the Wheat fell down, *i. e.* causes the Ears to be light (*a*).

And we find, that those who practise this Method of feeding their Wheat with Sheep in the Spring, to prevent the lodging of it, have most commonly their Straw weak, and Ears light.

These, instead of making the Stalks strong enough to support heavy Ears, make the Ears light enough to be supported by weak Stalks. They know that heavy Ears make the greatest Crop; and yet they still hope to have it from light ones.

They *cause* the *Blight* by the very means they make use of to *cure* it.

This feeding of Wheat much retards the Time of its blossoming; and that it may blossom early, is one chief End of sowing it early, to prevent the Blight. But when it is fed, what the Plants send up next is but a Sort of second or latter Crop, which has longer to stand than the first would have required, and is always weaker than the first Crop would have been; and the longer time it has to continue on the Ground, the more Nourishment is required to maintain it; and yet, as has been shewn, the longer it has been sown, the more the Earth has lost of its Nourishment; and

(*c*) Heavy Ears never fall. If they did, that would not make them light. Wheat falls sometimes whilst 'tis in Grass, and before it comes into Ear; so far are the Ears from causing it to fall. This was proved by my whole Crop the last Harvest, and particularly by the *Measured Acre*, the Ears of which, tho' prodigious large and heavy, were none of them lodg'd, when those of sown Wheat on the other Side of the Hedge were fallen down flat, and lodg'd on the Ground.

confe-

consequently, the Crop will be yet weaker, and in more Danger of the starving Blight (*b*).

The most effectual Remedy against the Blight is that which removes all its Causes (except such extraordinary ones as Lightning); as,

First, *Want of Nourishment*.

The Horse-hoe will, in wide Intervals, give Wheat, throughout all the Stages of its Life, as much Nourishment as the discreet Hoer pleases.

Secondly, *Want of Air*.

Air, being a Fluid, moves most freely in a right or strait Line; for there the fewest of its Parts meet with any Resistance; as a strait River runs swifter than a crooked one, from an equal Declivity; because more of the Water strikes against the Banks at

(*b*) I am sure, that whenever Sheep break into my drill'd Wheat in the Spring, it lessens my Crop half, just as far as they eat the Rows. There are several Reasons why Sheep are more injurious to drilled Wheat than sown: I would not therefore be understood to decry the Practice of seeding sown Wheat, when the Thickness and Irregularity of its Plants make it necessary: I have only endeavoured to shew, that that Practice is founded upon a false Theory. For, if Wheat fell down by reason of the Luxuriance of it, a Plant of it would be more likely to fall when single, and at a great Distance from every other Plant, than when near to other Plants, because such a single Plant is (*ceteris paribus*) always the most luxuriant; and I have not seen such a one fall (except Birds pull down the Ears), but have observed the contrary, though its Ears are the largest.

The Subject I write on is Drilling and Hoeing, and of whatsoever else I think relates to the Practice or Theory thereof; which obliges me to advise against Drilling too thick upon any Sort of Land; but more especially upon very rich Land: For though I have no such Land, yet I apprehend, that a too great Number of Plants may overstock the Rows, and cause them to be liable to some of the Inconveniences of sown Wheat; and in such a Case, perhaps, Sheep may be rather useful than prejudicial to the drilled Wheat; but of this I have had no Experience: And if it should be too thick, it will be owing to the Fault of the Manager or Driller; but, I suppose, it might be a better Remedy to cut out the superfluous Plants by the Hand-hoe, in the manner that superfluous Turneps are hoed out.

the Turnings, and is there somewhat retarded: and the rest moving no faster than in the strait River, the whole Stream of the crooked must be slower in its Course, than that of the strait River.

The Air cannot pass thro' sown Corn in a direct Line, because it must strike against, and go round every Plant, they standing all in the Way of its Course, which must stop its Current near the Earth.

And the Air amongst sown Corn is like Water amongst Reeds or Osiers in the Side of a River; it is so stopp'd in its Course, that it almost becomes an Eddy; and since Air is about Eight hundred Times lighter than Water, we may suppose its Current thro' the Corn is more easily retarded, especially near the Earth, where the Corn has occasion for the greatest Quantity of Air to pass: For, tho' the upper Part of the Wheat be not able to stop a slow Current of Air, yet it does so much raise even a swift one, as to throw it off from the Ground, and hinder it from reaching the lower Parts of the Stalks, where the Air must therefore remain, in a manner, stagnant; and the thicker the Wheat is, where it stands promiscuously, the less Change of Air can it have, tho' the greater the Number of the Stalks is, the more fresh Air they must require.

But the confused Manner in which the Plants of sown Wheat stand, is such, that they must all oppose the free Entrance of Air amongst them, from whatever Point of the Compass it comes.

Now it is quite otherwise with Wheat drill'd regularly with wide Intervals; for therein the Current of Air may pass freely (like Water in a strait River, where there is no Resistance), and communicate its Nitre to the lower as well as upper Leaves, and carry off the Recrements they emit, not suffering the Plants to be weaken'd, as an Animal is, when his Lungs are forc'd to take back their own Expirations, if debarr'd from a sufficient Supply of fresh untainted Air. And
this

this Benefit of fresh Air is plentifully, and pretty equally, distributed to every Row in a Field of ho'd Wheat.

Thirdly, *Want of the Sun's Rays.*

Sown Wheat-plants, by their irregular Position, may be said to stand in one another's Light, for want of which they are apt to fall.

'Tis true the whole Field of Plants receive the same Quantity of Sun-beams amongst them, whether they stand confusedly, or in Order: But there is a vast Difference in the Distribution of them; for none or the very least Share of Beams is obtain'd by those Parts which need the greatest Share, in the confused Plants. And when the crural Parts, that should support the whole Body of every Plant, are depriv'd of their due Share of what is so necessary to strengthen them, the Plants (like Animals in the same Case) are unable to stand.

But in drill'd Wheat, where the Plants stand in a regular Order, the Sun-beams are more duly distributed to all Parts of the Plants in the Ranks; for which Way soever the Rows are directed, if they be strait, the Rays must, some time of the Day, fall on the Intervals, and be reflected by the Ground, whence the lower Parts of the Wheat-stalks must receive the greater Share of Heat, being nearest to the Point of Incidence, having no Weeds to shadow them.

As to that Cause of the Blight, *viz.* the Wheat's dying before the full Time of its Pregnancy be accomplish'd; the Hoe removes all the Objections against planting early, and then it will blossom the earlier: And it has visibly kept Wheat green a whole Week longer, than unho'd Wheat adjoining to it, planted the same Day.

The Antients were perfect Masters of the Vine-Husbandry, which seems to have so engross'd their rural Studies, that it did not allow them so much Reflection, as to apply the Use of those Methods to the

Increase of Bread, which they had discover'd to be most beneficial for the Increase of Wine. One Method was, to hoe the Vines after they had blossom'd, in order to fill the Fruit, as in *Columella*, Lib. iv. Cap. 28. *Convenit tum crebris Fossionibus implere: nam fit uberior Pulverationibus.* And if what *Palladius* says, *Tit. ix.* be true of the Sarritions and Sarculations in the Month of *January*, and that if Beans do twice undergo that scratching Operation, they will produce much Fruit, and so large as to fill the Bushel almost as full when shal'd as unshal'd.

Faba, si bis sarculetur, proficiet, & multum Fructum & maximum afferet, ut ad Mensuram Modii complendi fresa propemodum sicut integra respondeat.

This is to be done when Beans are Four Fingers high, and Corn when it has Four or Five Leaves to a Plant; even then the Harrowing-work, tho' it tore up some of the Plants, yet it was observ'd to do Good against the Blight.

Si siccas Segetes sarculaveris, aliquid contra Rubiginem præstitisti, maxime si Ordeum secum sarrietur.

When the Antients observ'd this, 'tis a Wonder they did not plant their Corn so as to be capable of receiving this Benefit in Perfection. They might have imagin'd, that what was effectual against the Blight, when the Corn was in Grass, must, in all Probability, be much more effectual when in Ear.

But the most general Blight that happens to Wheat in cold Climates, is caused by Insects, which (some think) are brought in the Air by an East Wind accompanied with Moisture, a little before the Grain is filling with that milky Juice, which afterwards hardens into Flour. These Insects deposit their Eggs within the outer Skin (or Rind) of the Stalks; and when the young ones are hatched, they feed on the *Parenchyma*, and eat off many of the Vessels which should make and convey this Juice; and then the Grain will be more or less thin, in Proportion to the
Number

Number of Vessels eaten, and as the Insects happen to come earlier or later; for sometimes they come so late, that the Grain is sufficiently fill'd with the said milky Juice before the Vessels are eaten; and then, tho' the Straw appear thro' a Microscope to have its Vessels very much eaten and torn, and to be full of black Spots (which Spots are nothing else but the Excrements of those young Insects), yet the Grain is plump, and not blighted, there being an Observation, That the early sown Wheat generally escapes this Blight. And it has been seen, where one Part of a Field is sown earlier than the other Part, without any other Difference than the Time of sowing, that the Grain of the latest sown has been much blighted, and the Grain of the earlier has escaped the Blight, tho' the Straw of both were equally eaten by the Insects. Hence it may be inferr'd, that the Milk in the one had receiv'd all the Nourishment necessary to its due Consistence, before the Vessels were destroy'd; but, in the other, the Vessels, which should have continued the Supply of Nourishment for thickening the Milk, being spoil'd before they have finish'd that Office, it remains too thin; and then the Grain, when it hardeneth, shrinks up, and is blighted; yet the Grain of one and the other are equally plump until they become hard: The Difference therefore is only in the Thickness of the Milk, that in the blighted being more watery than the other.

The chief Argument to prove, that these Insects are brought by an East Wind, is, that the Wheat on the East Sides of Hedges are much blighted, when that on the West Sides is not hurt: And as to the Objection, that they are bred in the Earth, and crawl thence up the Stalks of the Wheat, because some Land is much more subject to produce blighted Wheat than other Land is; perhaps this Difference may be chiefly owing to the different Situation of those Lands, as they are opposed to the *East*, or to the *West*.

Another

Another Cause why some Wheat is more blighted than other Wheat on the same Land, is, the different Condition in which the Insects find it; for the Rind of that which is very strong and flourishing (*c*) is soft and tender; into this they can easily penetrate to lay their Eggs; but the Wheat that is poor and yellow, has an hard tough Skin (or Rind), into which the Insects are not able to bore for the Intromission of their Eggs, and therefore can do it no Mischief. It would be in vain to advise to prevent the Blight, by striving to make the Wheat poor; for tho' Poverty may preserve Wheat from this Blight, as well as it does People from the Gout, yet that is a Remedy which few take willingly against either of these Diseases: But this, I think, might be possible to remedy it, if we could, from the strongest Wheat, take away so much Nourishment as to turn its Colour (*d*) a little yellowish just before the Insects come (*e*) which I suppose to be in *June*, after the Ear is out, or at least fully formed.

Yet this can only be done in wide Intervals; for, unless the fine Earth can be thrust to some considerable Distance from the Roots after they are cut off, they will soon shoot out again, and reach it, becoming more vigorous thereby.

In dry Summers this Misfortune seldom happens, much Heat, and very little Moisture, being most agreeable to the Constitution of Wheat; for then its Rind

(*c*) Some Sort of Land is more subject to this Blight than others; in such, Larvas Wheat must by no means be drill'd late, and too thin, lest it should not tiller till late in the Spring; and then, for want of a sufficient Quantity of Stalks to disperse with all the Nourishment rais'd by the Hoe, may become too vigorous and luxuriant, and be the more liable to the Injury of the Blight of Insects.

(*d*) But this is a very difficult Matter.

(*e*) Whither those Insects go, or where they reside, from the Time of their eating their Way out of the Straw, until they return the next Year, I cannot learn.

is more firm and hard, as it is, on the contrary, made more soft and spongy by too much Moisture.

The most easy and sure Remedy, that I have yet found against the Injury of these Insects, is, to plant a Sort of Wheat that is least liable to be hurt by them; *viz.* The *White-cone* (or bearded) *Wheat*, which has its Stalk or Straw like a Rush, not hollow, but full of Pith (except near the lower Part, and there 'tis very thick and strong): 'Tis probable it has Sap-Vessels that lie deeper, so as the young Insects cannot totally destroy them, as they do in other Wheat: For when the Straw has the black Spots, which shew that the Insects have been there bred, yet the Grain is plump, when the Grey-cone and Lammas Wheat mixt with it are blighted. This Difference might have been from the different times of ripening, this being ripe about a Week earlier than the Grey-cone, and later than the Lammas: But its being planted together both early and late, and at all Times of the Wheat-seed Time, and this White-cone always escaping with its Grain unhurt, is an Argument, that 'tis naturally fortify'd against the Injury of these Insects, which in wet Summers are so pernicious to other Sorts of Wheat; and I can impute it to no other Cause than the different Deepness of the Vessels, the Straw of other Wheat being very much thinner, and hollow from Top to Bottom; this having a small Hollow at Bottom, and there the Thickness betwixt the outer Skin and the Cavity is more than double to that in other Sorts of Wheat; so that I imagine, the Insects reach only the outermost Vessels, and enough of the inner Vessels are left untouch'd to supply the Grain.

This Wheat makes very good Bread, if the Miller does not grind it too small, or the Baker make his Dough too hard, it requiring to be made softer than that of other Flour.

A Bushel of this White-cone Wheat will make more Bread than a Bushel of Lammas, and of the same

same Goodness ; but it gives a little yellow Cast to the Bread.

Another Sort of lodging Blight there is, which some call *Moar-Loore*, and mostly happens on light Land. This is when the Earth, sinking away from the Roots, leaves the Bottom of the Stalk higher than the subsided Ground ; and then the Plant, having only these naked Roots to support it (for which they are too weak), falls down to the Earth.

To remedy this, turn a shallow Furrow against the Rows, when they are strong enough to bear it, and when the Mould is very fine and dry ; then the Motion of the Stalks by the Wind will cause such Earth to run through the Rows, and settle about the Roots, and cover them (*f*).

I have never seen any drill'd Wheat so much spoil'd by falling, as sown Wheat sometimes is. The drill'd never falls so close to the Ground, but that the Air enters into Hollows that are under it, and the Wind keeps the Ears in Motion. Notwithstanding all the Precaution that can be used, in some unseasonable Years Wheat will be blighted: I have known such a general Blight, when some of my Lammas Wheat, planted late on blighting Land, was blighted, amongst the rest of my Neighbours, by the Insects, but the Grain of the sown Wheat was vastly more injured

(*f*) Some Land is very subject to the Misfortune of exposing the Roots, and therefore is less proper for Wheat ; for when the Roots are left bare to the Air, they will be shivelled, and unable to support the Plants : And on such Land the Wheat plants have all fallen down, though in Number and Bigness not sufficient to have produced the Fourth Part of a tolerable Crop, if they had stood. I am inclined to believe that a thorough Tillage might be a Remedy to such a loose hollow Soil ; for 'tis certain to a Demonstration, that it would render it more *dense*, and increase its specific Gravity : But to enrich it sufficiently without Manure, the Tillage must pulverize it much more minutely, and expose it longer, than is required for the strongest Land : The Fold also will be very helpful on such hollow Land.

than

than that of the drill'd: The former was so *light*, that the greatest Part was blown away in winnowing, and the Remainder so *bad*, that it was not fit to make Bread: The drill'd made as good Bread, and had as much Flour in it, as the sown Wheat had, that was not blighted; for the Grains of the drill'd were much larger than those of the sown; being form'd to have been twice as big as the Grains of Wheat generally are, had they not been blighted.

C H A P. XII.

Of ST. FOIN.

ST. FOIN, from the Country we brought it from, is call'd *French Grass*: And for its long Continuance, some having lasted Forty Years, 'tis call'd *Everlasting Grass*, tho' it be not strictly a *Gramen*.

'Tis call'd in *French*, *Sain Foin*, i. e. *Sanum Fœnum*, from its Quality of Wholsomeness, beyond the other artificial Grasses, green and dry. 'Tis also call'd *Sanctum Fœnum*, Holy Hay.

'Tis a Plant so generally known to every Body, that there is no need to give any formal Description of that Part of it which appears above-ground, It has many red Flowers, sometimes leaving Ears Five or Six Inches long: I have measured the Stalks, and found them above Five Feet long, tho' they are commonly but about Two Feet.

The Reason why *St. Foin* will, in poor Ground, make a Forty times greater Increase than the natural Turf, is the prodigious Length (a) of its perpendicular

(a) There is a vulgar Opinion, that *St. Foin* will not succeed on any Land, whose there is not an under *stratum* of Stone or Chalk,

cular Tap-root: It is said to descend Twenty or Thirty Feet. I have been inform'd, by a Person of undoubted Credit, that he has broken off one of these Roots in a Pit, and measured the Part broken off, and found it fourteen Feet.

This Tap-root has also a Multitude of very long horizontal Roots at the upper Part thereof, which fill all the upper *Stratum*, or Staple of the Ground; and of thousands of *St. Foin* Roots I have seen taken up, I never found one that was without horizontal Roots near the Surface, after one Summer's Growth; and do much wonder how Mr. *Kerckham* should be so mistaken, as to think they have none such.

Also these Tap-roots have the horizontal ones all the Way down; but as they descend, they are still shorter and shorter, as the uppermost are always the longest.

Any dry Ground may be made to produce this noble Plant, be it never so poor; but the richest Soil will yield the most of it, and the best.

Chalk, to stop the Roots from running deep; else, they say, the Plants spend themselves in the Roots only, and cannot thrive in those Parts of them which are above the Ground. I am almost ashamed to give an Answer to this.

'Tis certain that every Plant is nourished from its Roots (as an Animal is by its Guts); and the more and larger Roots it has, the more Nourishment it receives, and prospers in proportion to it. *St. Foin* always succeeds where its Roots run deep; and when it does not succeed, it never lives to have long Roots; neither can there ever be found a Plant of it, that lives so long as to root deep in a Soil that is improper for it: Therefore 'tis amazing to hear such Reasoning from Men.

An under *Stratum* of very strong Clay, or other Earth, which holds Water, may make a Soil improper for it; because the Water kills the Root, and never suffers it to grow to Perfection, or to attain to its natural Bulk. The best *St. Foin* that ever I saw, had nothing in the Soil to obstruct the Roots, and it has been found to have Roots of a prodigious Depth. If there be Springs near (or within several Feet of) the Surface of the Soil, *St. Foin* will die therein in Winter, even after it has been vigorous in the first Summer; and also after it hath produced a great Crop in the second Summer.

If you venture to plant it with the Drill, according to the Method wherein I have always had the best Success; let the Land be well prepared before you plant it. The Seed, if not well ordered, will very little of it grow; therefore 'tis convenient to try it in the manner mention'd in the Chapter of *Hoeing*; where are also Directions to find the proper Quantity and Depth to plant it at: I have observ'd, that the Heads of these Seeds are so large, and their Necks so weak (*b*), that if they lie much more than half an Inch (*c*) deep, they are not able to rise through the incumbent Mould; or if they are not cover'd, they will be malted (*d*). A Bushel to an Acre is full twenty Seeds to each square Foot, in all I try'd; but there is odds in the Largeness of it, which makes some Difference in the Number.

The worst Seasons to plant it are the Beginning of Winter, and in the Drought of Summer. The best Season is early in the Spring.

'Tis the stronger when planted alone, and when no other Crop is sown with it (*f*).

If

(*b*) The Kernel or Seed, being much swollen in the Ground, I call the Head: This, when it reaches above the Ground, opens in the Middle, and is formed into the Two first Leaves; the Husk always remaining at the same Depth at which it is cover'd: The String that passes from the Husk to the Head, is the Neck; which, when by its too great Length 'tis unable to support the Head till it reaches to the Air, rises up, and doubles above it; and when it does so, the Head, being turn'd with its Top downwards, never can rise any higher, but there rots in the Ground.

(*c*) In very light Land the Seed will come up from a greater Depth; but the most secure Way is, not to suffer it to be cover'd deep in any Land.

(*d*) We say it is malted, when it lies above-ground, and sends out its Root, which is killed by the Air. And whether we plant *bad* Seed that does not grow, or *good* Seed buried or malted, the Consequence will be much the same, and the Ground may be equally understock'd with Plants.

(*f*) The worst Crop that can be sown amongst *St. Foins*, is Clover or Rye-Grass; Barley or Oats continue but a little while

to

If Barley, Oats, or other Corn sown with St. Foin, do lodge, it will kill (*g*) the young St. Foin that is under it: But then so great a Crop of Corn will certainly answer the very little Expence of drilling the St. Foin again, either the next Year, or as soon as the Corn is off the Ground.

St. Foin drill'd betwixt Rows of Barley or Oats, always is stronger than when drill'd amongst Corn that is sown at random; and therefore is in less Danger of being kill'd by the Lodging of the Corn; neither is the Corn in Rows so liable to fall as the other.

The Quantity of Seed to be drill'd on an Acre will depend, in great Measure, upon the Goodness of it; for in some bad Seed, not more than One in Ten will grow; and in good Seed, not One in Twenty will miss; which is best known by stripping off the Husks of a certain Number of Seeds, and planting the Kernels in Earth, in the manner directed for

to rob it; but the other artificial Grasses rob it for a Year or Two, until the artificial Pasture is near lost; and then the St. Foin never arrives to half the Perfection as it will do when no other Grass is sown amongst it.

The Injury these Hay-crops do to the St. Foin is best seen where some Parts of the same Field have them, and the other Parts are without them.

(*g*) When Barley, among which the St. Foin is planted in a dry Summer, is great, there are few Farmers that know till the next Spring, whether the St. Foin succeeds or not; because the young Plants are not then visible; unless it be to those who are accustomed to observe them in all the Degrees of their Growth, I have seen a Field of Ten Acres of such, wherein, after the Barley was carried off, nothing appeared like St. Foin; but when by the Print of the Channels I searched diligently, I found the small St. Foin Plants thick enough in the Rows; they had no Leaves, they being cut off by the Scythe; no Part of them that was left had any Green Colour; but from the Plants there came out many Sprigs like Hog's Bristles, or like the Beard of Barley: This whole Piece of St. Foin succeeded so well, that the Third Year its Crop was worth Three Pounds *per* Acre, the Land being good.

finding

finding the proper Depth to plant at, which, in this Case, let be half an Inch: This being done, the Quality of the Seed will be known. But until frequent Trials have furnish'd Experience enough to the Planter to know the Difference, let him observe, that the following are good Signs; *viz.* The Husk of a bright Colour, the Kernel plump, of a light-grey or blue Colour, or sometimes of a shining black; yet the Seed may be good, tho' the Husk is of a dark Colour, if that is caused by its receiving Rain in the Field, and not by heating in a Heap, or in the Mow; and if you cut the Kernel off in the Middle, cross-ways, and find the Inside of a Greenish fresh Colour, it's surely good; but if of a yellowish Colour, and friable about the Navel, and thin, or pitted, these are Marks of bad Seed.

The Quantity, or rather Number of Seeds convenient to drill, ought to be computed by the Number of Plants (*b*) we propose to have for making the best Crop, allowing for Casualties (*c*).

In

(*b*) Not that we need to be so exact as to the Number of Plants, whether they be Two, Three, or Four hundred upon a square Perch. Neither is it possible to know beforehand the precise Number of Plants that may live; for sometimes the Grub kills many, by eating off the first Two Leaves.

(*c*) Many even of the best of Seeds, both sown and drill'd, are liable to Casualties, but not equally; for about Twenty-eight Years ago, my Servants (being prime Seedsmen) had a Fancy in my Absence to try an Experiment of the Difference betwixt sowing and drilling of St. Foin; and in the Middle of a large Field of my best Land they sow'd a square Piece of Three Acres, at the Rate of One Bushel to an Acre, not doubting but, by their skill in sowing even, it would succeed as well as if drill'd; but it succeeded so much against their Expectation, that the Land all round it, which was drill'd at the same Time, with the same Proportion of the same Seed, brought extraordinary good Crops of St. Foin; but the sow'd Part was so very thin, that tho' it lay still with the rest for Eight Years, it never was a Crop, there not being above Three or Four upon a square Perch, taking the Three Acres all together: Not that it can be supposed,

In drilling St. Foin not to be ho'd, and before the Ploughs of my Drill were so perfect in making narrow Channels as they are now (for, when the Channels were open, they had Six times the Breadth, wherein Part of the Seed was wasted), then my Quantity was One Bushel to an Acre, sometimes Six Gallons.

But a single Acre (in the middle of a large Field of St. Foin) being drill'd late in *October*, the frosty Winter kill'd at least Nineteen of Twenty Parts (*d*) of that Bushel. At first it made such a poor Appearance, that 'twas by mere Accident, or it had been plow'd up for a Fallow; but, missing of that, a few Plants were perceiv'd in the Summer, which by their Singleness grew so vigorous, and so very large, that the Second Year of Mowing it (*e*) produc'd a Crop double to the rest of the same Field, which was drill'd in the Spring, with the same Proportion of Seed, and none of it kill'd: tho' all this Field was a much better Crop than some that was sown in the common Manner, with Seven Bushels to an Acre. I have generally observ'd the thin (*f*) to make the best Crop, after the First or Second Year.

I have

that the sown would always meet with so many Casualties as this did; for then Eight Bushels sown to an Acre might have been too thin, and much thinner than all the rest of the Field was, tho' drill'd with only One Bushel to an Acre: And 'tis often seen, that when an Acre is sown with seven Bushels of Seed, the St. Foin is as much too thick, as that sown with One Bushel was too thin.

I do not know, that of the many hundred Acres of St. Foin, that have been drill'd for me, ever one Acre was too thin, except when planted with Wheat: The young Plants were kill'd by the Frost.

(*d*) But I believe, there might remain alive Three or Four Plants to each square Yard, standing single, and at pretty equal Distances.

(*e*) But *Note*, This Acre was dunged, and in better Order than the rest.

(*f*) But, notwithstanding I commend the Planting of St. Foin thin, that most of the Roots may be single; yet I have Fields that

I have also often observ'd in Lands of St. Foin, lying disperſed in a common Field (but where there was not Common for Sheep), and where the Ends of other Lands kept in Tillage, pointed againſt the Pieces of St. Foin; and the Horſes and Ploughs turning out upon the St. Foin (g) did plow and ſcratch out a Multitude of its Plants; ſo that it was thought to be ſpoil'd, and Law-fuits were intended for Re-compence of the Damage; that afterwards this ſcratch'd Part, ſuppoſed to be ſpoil'd, became twice as good as the reſt of the ſame Pieces, where the Ploughs did not come to tear up any Plants.

The Reason why the ſingle St. Foin Plants make the greateſt Crops, is, that the Quantity of the Crop is always in Proportion to the Quantity of Nouriſhment it receives from the Earth; and thoſe Plants which run deepeſt will receive moſt; and ſuch as are ſingle will run deeper than thoſe which are not ſingle.

Alſo the ſingle do ſend out all round them horizontal Roots, proportionably ſtronger and larger, whereby they are better able to penetrate, and extract more Nouriſhment from the Staple, or upper *Stratum*, than the other can do, if there be a competent Number; which is, when ho'd, fewer than any-

that were drill'd with but Four Gallons of Seed to an Acre; and yet the Rows being Seven Inches aſunder, the Roots are ſo thick in them, that the Ground is cover'd with the St. Foin Plants, which ſeem to be as thick (in Appearance) as moſt ſown St. Foin, whereon Seven or Eight Buſhels are ſown on an Acre. And I have other Fields that were drill'd with about Two Gallons of Seed to an Acre (which is Five Seeds to each ſquare Foot), the Rows Sixteen Inches aſunder, that produce better Crops, tho' the Ground be poorer. The drill'd St. Foin, being regular, is more ſingle, tho' as thick as the ſown; and for that Reason always makes a better Crop, and laſts longer than the ſown that is of the ſame Thickneſs, but irregular.

(g) This Plowing and Scratching was a ſort of Hoeing, which helped the St. Foin by a ſmall Degree of Pulveration, as well as by making the Plants thinner.

body imagines. 'Tis common to see a single St. Foin have a bigger Tap-root than Twenty thick ones: Their Length is in Proportion to their Bigness: Therefore that single Plant may well be supposed to have Twenty times more Depth of Earth to supply it, than all those Twenty small Roots can reach to. And tho' these under *Strata* are not so rich as the upper; yet, never having been drain'd by any Vegetable, they do afford a very considerable Quantity of Nourishment to those Roots which first enter them.

The small thick Plants are so far from equalling the Product of the single, by their Excess of Number, that the more they are, the smaller, shorter, and weaker they become; less Nourishment they have, and the less Crop they produce; and are soon starv'd, decay, and die, unless reliev'd by the Expence of frequent Manure, or that the Soil be very rich.

Single Plants exceed the other by a Multitude of Degrees, more than a Giant does a Dwarf, in Strength, as well as Stature; and therefore when natural Grass happens to come, are so much the better able to shift amongst it.

The single Plants seem also to exceed the other in their Longevity; for 'tis observ'd, that all St. Foin that has continu'd great for a good Number of Years without Manure, has been so single, that the Owners have determin'd to plow it up at the Beginning, for the Thinness of it.

How long this may last by Culture, I can't tell; but undoubtedly much longer than without it; and I can say, that I never knew a Plant of St. Foin die a natural Death; the most common End of it is Starving. And when an hundred thick Plants have not the Nourishment which One single Plant has, 'tis no Wonder that these (in a Croud (*b*) thus besieg'd with Hunger) should be starv'd before it.

(*b*) Sown Plants, when too thick, are crowded on every Side; but those that are drill'd, have always Room enough on Two Sides of them; unless the Rows are too near together.

Another Advantage the single have, in respect of Moisture: These reach to a Depth where that is never wanting, even when the upper *Stratum* or Staple is parch'd up, as appears by the Experiment of the Mints, that if any Root of a Plant has Moisture, that Root will communicate a Share to all the rest. Hence it is, that, in the driest Summer, these single Plants make a great Crop, when the other yield next to nothing. I remember I once saw a Farmer coming out of a Ground with a Load of St. Foin Hay, which he assured me was all he could find worth cutting, out of Forty Acres of this thick sort, in full Perfection, Three Years after sowing: He valued his Load at Three Pounds; but withal said it came off so much Ground, that the Expence of Mowing, Raking, &c. was more than the Value; when, in the very same dry Summer, there was Three Tun of St. Foin to an Acre in a Field (*i*), where it was drill'd single and regularly.

And I have often observ'd, that where the Plants are thin, the Second Crop of them springs again immediately after cutting; when Plants that stand thick in the same Ground, spring not till Rain comes; and I have seen the thin grown high enough to cut the Second time, before the other began to spring.

The best way to find what Number of these Plants it is proper to have on a Perch of Ground, is to consider what Quantity of Hay one large Plant will produce (for, if cultivated, they will be all such).

Without Culture these Plants never attain to a Fourth Part of the Bulk they do with it: Therefore very few have seen any one Plant at its full Bigness. One Plant, well cultivated, has in the same Ground

(*i*) This was on rich deep Land in *Oxfordshire*; and the other St. Foin, which was so poor, was on thin Slate Land near *Casbam* in *Wiltshire* in the *Bath Road*. It is now about Forty Years since.

made a greater Produce, than One thousand small ones uncultivated.

But the Hay of a large single cultivated Plant will weigh more than half a Pound; and 112 Plants upon a square Perch, weighing but a Quarter of a Pound apiece one with another, amount to Two Tun to an Acre.

If St. Foin be planted on some sorts of Land early in the Spring, and ho'd, it may bring a Crop the same Summer; for I once planted a few Seeds of it on sandy Ground in my Garden, at the End of *February*, which produced large Plants above Two Feet high, that went into Blossom the following *June*; tho' there was a severe Frost in *March*, which kill'd abundance of Wheat, yet did not hurt these Plants: This shews that St. Foin is a quick Grower, unless it be planted on poor cold Ground, or for Want of Culture.

And tho' the poor Land, and ill Management generally allotted to it, cause it to yield but One mowing Crop a Year; yet it has yielded Two great ones on rich sandy Land, even when sown in the common ordinary matter.

Thin St. Foin cannot be expected to cover all the Ground at first, any more than an Orchard of Apple-trees will, when first planted at Thirty Feet Distance from each other every Way; yet this is reckon'd a proper Distance to make a good and lasting Orchard. But if these should be planted at Three Feet Distance, as they stand in the Nursery, it would not be more unreasonable than the common Method of sowing St. Foin is; and there would be much the same Consequence in both, from covering all the Ground at first Planting; except that the St. Foin, being abundantly longer rooted downwards than Apple-trees are, has the greater Disadvantage, when by its Thickness 'tis prevented

prevented from growing to its full Bulk, and Length of Roots (*k*).

The Difference is only this: People are accustom'd to see Apple-trees planted at their due Distance: but few have seen St. Foin planted and cultivated at the Distance most proper to St. Foin; or ever consider'd about it, so much as to make the necessary Trials.

I have constantly found, that, upon doubling any Number of narrow Rows, having equal Number of Plants in each Row, the Crops have been very much diminish'd; and, upon leaving out every other Row, that is, lessening the Number of Rows to half, the Crops are increased; and where Two Rows are wide asunder at one End of a Piece, and near at the other End, the Plants are gradually less and less, as the Rows approach nearer together.

We ought never to expect a full Crop of St. Foin the First Year (*l*), if we intend to have good Crops afterwards, and that it shall continue to produce such, for the same Reasons that must be given for planting an Orchard at other Distances than a Nursery.

The common Error proceeds from mistaking the Cause of a great or small Crop.

Where the Spaces betwixt Rows are wide (if there be not too many Plants in them) we always see the St. Foin grow large, and make the greatest Crop; but when 'tis young, or after cutting, we see room

(*k*) Horizontal-rooted Plants suffer no greater Injury by their Pasture's being over-stock'd than Cattle do; because their Pasture lying near the Surface of the Ground, they have it all amongst them: But St. Foin, and other long Tap-rooted Plants suffer yet more, because great Part of their over stock'd Pasture is lost by them all, when they hinder one another from reaching down to it, by shortening one another's Roots, which they do when they all become Dwarfs by reason of their Over-thickness.

(*l*) But when it has been planted on rich sandy Land, and proper, it has produced very great Crops the first Year; but then the Summer wherein it grew amongst the Barley, must not be reckoned as the first Year.

(as we fanſy) for more of ſuch Plants, to make a yet larger Crop; not conſidering that 'tis the Widenefs of thoſe Spaces, and leſs Number of Plants, that cauſe the Crop to be ſo large, there being more Paſture for thoſe Plants.

Where theſe Spaces are narrower, and the Rows of equal Thickneſs, we ſee the Plants leſs when grown, and that they make a leſs Crop; and yet there ſeems to be room for more Rows, which we fanſy might make the Crop larger, not conſidering that 'tis the Narrowneſs of thoſe Spaces that cauſes the Plants and Crop to be leſs, for want of ſufficient Paſture.

Thus, fondly increaſing the Number of our Rows and Plants, we bring our Crop (unleſs the Soil be rich) to nothing, by too much over-ſtocking their Paſture; and, if that Paſture be over-ſtock'd, the Crop will be diminifh'd more than in proportion to that Over-charge; for perhaps 'tis not impoſſible to prove (if we would be curious), that Plants, by wanting a Fourth Part of their due *Quantum* of Nourifhment, will be diminifh'd to half (*m*) of the Bulk they would have attained to, had they been ſupply'd with the other Fourth Part.

I have obſerv'd ho'd St. Foin to grow more, and increaſe its Bulk more, in Two Weeks, than unho'd St. Foin in the ſame Ground (and without any other Difference) hath done in Six Weeks; and the quicker it grows, by being better fed, the ſweeter and richer Food it will make for Cattle, whether it be ſpent green or dry (*n*).

(*m*) When Plants have not their due Nourifhment, they ſuffer the more by Cold and Drought; ſo that want of Nourifhment diminifhing their Gr with One-fourth, Cold, or Drought, or both, may diminifh it another fourth.

(*n*) Cattle are the beſt Judges of the Goodneſs of Graſs, and they always chooſe to feed on St Foin that is moſt vigorous, and reſuſe that which is poor and yellow. And the richeſt ſweeteſt Graſs will always make the beſt Hay; for the drying of it does not change the Quality of the Graſs.

At whatever Distance the Rows be set, if they have too many Plants in them, the Crop will be very much injured; and the greater the Excess is beyond the just Number, the more void Space there will be amongst them; because the smaller the Plants are, the less Ground they cover.

I have had the Experience of drilling at all Distances, from Thirty-three Inches to Seven Inches, betwixt the Rows; and recommend the following Distance, for the different Methods of drilling; whether the *St. Foin* be design'd for hoeing, or not. As,

First, For *Horse-hoeing*, I think it is best to drill double Rows with Eight-inch Partitions, and Thirty-inch Intervals; which need only be ho'd alternately, leaving every other Interval for making the Hay thereon.

Indeed I have never yet had a whole Field of ho'd *St. Foin*; but have enough to shew, that Horse-hoeing makes it strong upon very poor Land, and causes it to produce two Crops a Year upon indifferent Land.

It is not necessary to hoe this every Year; but we may intermit the Hoeing for three or four Years together, or more, if the Land be good.

Whilst the Plants are small the first Year, Care must be taken not to cover them with the Plough: Afterwards there will be no great Danger, especially in Winter, the Earth not being suffered to lie on them too long.

Secondly, For *Hand-hoeing*, drill the Rows Sixteen Inches asunder, and single out the Plants, so as to make them Eight Inches apart at least in the Rows, contriving rather to leave the Master-plants, than to be exact in the Distance: This must be done whilst they are very young, or in Summer; else they will come again that are cut off by the Hoe.

Lastly, when *St. Foin* is drill'd without any Intention of hoeing, the best Way (I think) is to plant single Rows, at Eight Inches Distance, with no greater Quantity of Seed, than when the Rows are at Sixteen Inches Distance; because, by this Method, the same

same Number of Plants in the Rows, that are but Eight Inches apart, will be much more single, than those in the Rows at Sixteen Inches apart are, without being set out by the Hoe.

Which of these Methods soever is practis'd, the Land should be made as clean from all Grass, and as well pulveriz'd, as possible, before Drilling.

The Tines of the Drill-harrow must exactly follow the Shares, which leaving the Channels open, the Tines cover the Seed, some at Bottom, and some on each Side; so that it is cover'd very shallow, tho' it lies deep within the Ground, where there is more Moisture, than nearer to the upper level Surface: This causes the Seed to come up in dry Weather; and yet it is not in Danger of being buried by a too great Weight of Mould incumbent on it.

But take heed that no other Harrow come on it after 'tis drill'd; for that might bury it. I never care to roll it at all, unless on account of the Barley; and then only in very dry Weather, with a light Roller, lengthways of the Rows, immediately after 'tis drill'd; or else stay Three Weeks afterwards before it be roll'd, for fear of breaking off the Heads of the young *St. Foin*.

Be sure to suffer no Cattle to come on the young *St. Foin* the first Winter (*a*), after the Corn is cut that

(*a*) The first Winter is the Time to lay on Manure, after the Crop of Corn is off; such as *Peat-Ashes*, or the like; because, there being no natural Grass to partake of it, and the Plants being less, less will supply them; and because, when made strong in their Youth, they will come to greater Perfection: But I never used any Manure on my *St. Foin*, because mine generally had no Occasion for Manure before it was old; and *Soot* is seldom to be had of sufficient Quantity in the Country; and little *Coal* is burnt hereabouts, except by the *Smiths*, whose *Ashes* are not good. The Price and Carriage of *Peat-Ash* will be Ten Shillings for an Acre, which would yet be well bestowed in a Place where Hay is vendible; but, by reason of the great Quantity of watered Meadows, and Plenty of *St. Foin*, Clover, and Hay, raised of late Years by Farmers for their own Use,

that grows amongst it; their very Feet would injure it, by treading the Ground hard, as well as their Mouths by cropping it; Nor let any Sheep come at it, even in the following Summer and Winter.

One Acre of well-drill'd *St. Foin*, considering the different Goodness of the Crops, and the Duration of it, is generally worth Two Acres of sown *St. Foin* on the same Land, tho' the Expence of drilling be Twenty Times less than the Expence of sowing it.

One of the Causes why *St. Foin*, that is properly drill'd, lasteth longer (*b*) without Manure than the sown, is, That the former neither over nor understocks the Pasture; and the latter commonly, if not always, doth one or the other, if not both; *viz.* Plants too thick in some Places, and too thin in others; either 'tis not single, but in Bunches; or if it be single, 'tis too thin; it being next to impossible to have the Plants come true and regular, or nearly so, by sowing at *random*. Plants too thick soon exhaust the Pasture they reach, which never is more than a small Part of that below the Staple: When the Plants are too thin, the *St. Foin* cannot be said to last at all, because it never is a Crop.

They who *sow* Eight or Ten Bushels of good Seed on an Acre, in a good Season, among their Corn, with Intent that by its Thickness it should kill other Grass, reduce their *St. Foin* almost to that poor Condition I have seen it in, where it grows naturally

Use, here are now few or no Buyers of Hay, especially these open Winters; so that laying out Money in that Manner would be in Effect to buy what I cannot sell. I think it better to let a little more Land lie still in *St. Foin*, than to be at the Expence of Manure; but yet shall not neglect to use it, when I shall find it likely to be profitable to me.

(*b*) I have now a great many single *St. Foin* Plants in my Fields, that are near Thirty Years of Age, and yet seem as young and vigorous as ever; and yet it is common for thick *St. Foin* to wear out in Nine or Ten Years, and in poor Land much sooner, if not often manured by *Soot*, *Peat-Ash*, or *Coal-Ash*.

wild without sowing or Tillage, upon the *Calabrian Hills* near *Croto*: It makes there such a despicable Appearance, that one would wonder how any body should have taken it in their Head to propagate so unpromising a Plant; and yet there has scarce been an Exotic brought to *England* in this or the last Age, capable of making a greater or more general Improvement, were it duly cultivated.

Some think the *Cyprus* would exceed it; but I am afraid the Labour of shearing those Shrubs by the Hands of *English* Servants, would cost too much of its Profit.

Luserne, requiring more Culture, and being much more difficult to be fitted with a proper Soil, never can be so general as *St. Foin*.

But now let us consider the best Methods of ordering *St. Foin* for Hay and Seed. The Profit of *St. Foin* Fields, arising from either of these Ways, is a great Advantage to their Owner, above that of natural Meadows; for, if Meadow-hay cannot have good Weather to be cut in its Season, it can serve for little other Use than as Dung, and yet the Expence of mowing it, and carrying it off must not be omitted. But if there be not Weather to cut *St. Foin* before blossoming, we may expect it till in Flower, or may stay till the Blossoms are off; and if it still rain on, may stand for Seed, and turn to as good Account as any of the former: So that it has Four Chances to One of the Meadow.

The elevated, but not mountainous, Situation of the dry Land whereon *St. Foin* is mostly planted, renders it so commodious for making of Hay, that it escapes there the Injury of Weather, when Hay in low Meadows is utterly spoil'd.

On the high Ground the Wind will dry more in an Hour, than on the Meadows in a whole Day. The Sun too has a more benign Influence above, and sends off the Dew about Two Hours earlier in the Morning,

Morning, and holds it up as much longer in the Evening. By these Advantages the *St. Foin* has the more Time to dry, and is made with half the Expence of Meadow-hay.

But before the Manner of making it be describ'd, the proper Time of cutting it ought to be determin'd; and upon that depend the Degrees of its Excellence (besides upon the Weather, which is not in our Power); for tho' all Sorts of this Hay, if well made, be good, yet there is a vast Difference and Variety in them.

The several Sorts may be principally distinguish'd by the following Terms; *viz.* First, The *Virgin*. Secondly, The *Blossom'd*. Thirdly, The *Full-grown*. And, Fourthly, The *Thresh'd Hay*.

The First of these is best of all, beyond Comparison; and (except *Luserne*) has not in the World its Equal. This must be cut before the Blossoms appear: For when it stands till full-blown, the most spirituous, volatile, and nourishing Parts of its Juices are spent on the next Generation; and this being done all at once, the Sap is much depauperated, and the *St. Foin* can never recover that Richness it had in its Virgin State. And tho', when in Blossom, it be *literally* in the *Flower* of its Age, 'tis really in the *Declension* of it. If it be said, that what is not in the Stalk is gone into the Flower, 'tis a Mistake; because much the greatest Part of its Quintessence perspires thence into the Atmosphere.

And moreover, That all Vegetables are, in some Degree, weaken'd by the Action of continuing their Kind, may be inferr'd from those Plants which will live several Years, if not suffer'd to blossom; but, whenever they blossom, it causes their Death, tho' in the first Year of their Life. For in Plants (as Dr. *Willis* observes in Animals) Nature is more solicitous to continue the Species, than for the Benefit of the Individual.

Part of a drill'd *St. Fain* Ground was cut the Beginning of *May*, before blossoming (*c*); and from the Time of cutting, until it was set up in Ricks, being about Ten Days, the Sun never shone upon it (*d*); but the Weather was misty: At last it was forc'd to be carried together for fear of Rain, so green, that out of the largest Stalks one might wring milky Juice; yet by making the Hay up in several little Ricks; and drawing up a great Chaff Basket in the Middle of each, its Firing was prevented; but it look'd of a dark Colour by heating; and was the very best (*e*) Hay that ever I had.

The other Part of the Ground was afterwards cut in the Prime of its Flower, and made into Hay by the Heat of the Sun, without Rain or Mist: This came out of the Ricks at Winter with a much finer Colour, and as fine a Smell as the *Virgin Hay*; but did not come near it in fattening of Sheep, or keeping

(*c*) By cutting before blossoming, is not meant before any one Blossom appears; for here and there a Bud will begin to open with a red Colour long before the rest: Therefore, when we perceive only a very few Blossoms beginning to open (perhaps but One of a Thousand), we regard them as none.

(*d*) This also was an Advantage to this Hay; for Apothecaries find, that Herbs dried in the Shade retain much more of their Virtue than those dried in the Sun; but Farmers not having any such Conveniency of drying their Hay in the Shade with Safety, must always choose to dry it by the Sun; because in cloudy Weather there is Danger of Rain; and therefore such excellent Hay must be had by Chance; for to be well made in the Shade, it must be in Danger of being spoiled or damaged by Rain.

(*e*) This Hay, so cut before blossoming, has kept a Team of working Stone-horses, round the Year, fat without Corn; and when tried with Beans and Oats mixed with Chaff, they refused it for this Hay. The same fattened some Sheep in the Winter, in a Pen, with only it and Water; they thrived faster than other Sheep at the same time fed with Pease and Oats. The Hay was weighed to them, and the clear Profit amounted to Four Pounds *per Tun*. They made no Waste. Tho' the Stalks were of an extraordinary Bigness, they would break off short, being very brittle. This grew on rich Ground in *Oxfordshire*

Horses

Horses fat at hard Work without any Corn, as the Virgin Hay did.

This superfine Hay cannot well be had of poor uncultivated (*f*) *St. Foin*: because that may not be much above an Handful high, when 'tis in Condition to be so cut; and would then make a very light Crop, and would be a great while ere it sprang up again: But the rich will have Two or Three Tun to an Acre, and spring again immediately for a second Crop; so that little or no Quantity would be lost by so great an Improvement of it's Quality. For ho'd *St. Foin* upon a poor chalky Hill, cut at the same time with that uncultivated on a rich Valley, does in dry Weather grow again without Delay, when the Valley attends a Month or more for a Rain, to excite its vegetative Motion.

This Hay the Owner (if he be wise) will not sell at any common Price; but endeavour to have some of it every Year, if possible, for his own Use.

The Second Sort of *St. Foin* Hay is that cut in the Flower; and tho' much inferior to the *Virgin* Hay, it far exceeds any other Kind, as yet commonly propagated in *England*; and if it be a full Crop, by good Culture, may amount to above three Tun to an Acre. This is that *St. Foin* which is most commonly made; and the larger it is, the more nourishing for Horses. I have known Farmers, after full Experience, go Three Miles to fetch the largest stalky *St. Foin*, when they could have bought the small fine leafy Sort of it at home, for the same Price by the Tun.

The next and last Sort of *St. Foin* that is cut only for Hay, is, the *full-grown*, the Blossoms being gone, or going off: This also is good Hay, tho' it fall short, by many Degrees, of the other Two Sorts: It makes a greater Crop than either of them, because it grows to its full Bulk, and shrinks little in drying.

(*f*) I reckon Manure of *Peat-Ashes*, *Soot*, or the like, to be a Culture.

This

This gives the Owner a Third Chance of having Weather to make good Hay, and spins out the Hay-Season 'till about *Midsummer*; and then in about a Fortnight, or Three Weeks, after the Hay is finish'd, the Seed is ripe. But, first, of the manner of making *St. Foin* Hay.

In a Day or Two after *St. Foin* is mow'd, it will, in good Weather, be dry on the upper Side: Then turn the Swarths, not singly, but Two and Two together; for by thus turning them in Pairs, there is a double Space of Ground betwixt Pair and Pair, which needs but once raking; whereas, if the Swarths were turn'd singly, that is, all the same Way, suppose to the *East* or *West*, then all the Ground will require to be twice raked; at least, more of it, than the other Way.

As soon as both Sides of the Swarths are dry from Rain and Dew, make them up into little Cocks the same Day they are turn'd, if conveniently you can; for when 'tis in Cock, a less Part of it will be expos'd to the Injuries of the Night, than when in Swarth.

Dew, being of a nitrous penetrating Nature, enters the Pores of those Plants it reaches, and during the Night possesses the Room from whence some Part of the Juices is dry'd out: Thus it intimately mixes with the remaining Sap; and, when the Dew is again exhal'd, it carries up most of the vegetable Spirits along with it, which might have been there fix'd, had they not been taken away in that subtile Vehicle.

If *St. Foin* be spread very thin upon the Ground, and so remain for a Week in hot Weather, the Sun and Dew will exhaust all its Juices, and leave it no more Virtue than is in Straw.

Therefore tis best to keep as much of our Hay as we can from being expos'd to the Dews, whilst 'tis in making; and we have a better Opportunity of doing it in this, than in natural Hay; because the bigger the Cocks are, the less Superficies (in proportion

tion to the Quantity they contain) will be expos'd to the Dew, and *St. Foin* may be safely made in much larger Cocks than natural Hay of equal Dryness can, which, sinking down closer, excludes the Air so necessary for keeping it sweet, that if the Weather prevents its being frequently mov'd and open'd, it will ferment, look yellow, and be spoil'd. Against this Misfortune there is no Remedy, but to keep it in the lesser Cocks, until thoroughly dry. *St. Foin* Cocks (twice as big as Cocks of natural Hay), by the less Flexibility of the Stalk admitting the Air, will remain longer without fermenting.

This being able to endure more Days unmov'd, is also an Advantage upon another Account besides the Weather; for tho' in other Countries, People are not prohibited using the necessary Labour on *all Days* for preserving their Hay, even where the certainer Weather makes it less necessary than here, yet 'tis otherwise in *England*; where many a Thousand Load of natural Hay is spoil'd by that Prohibition for want of being open'd; and often, by the Loss of one Day's Work, the Farmer loses his Charges, and Year's Rent; which shews, that to make Hay while the Sun shines, is an exotic Proverb against *English* Laws; whereunto *St. Foin* being, in regard of Sundays and Holidays, more conformable, ought to be the Hay as proper to *England* as those Laws are.

But to return to our Hay-makers: When the first Cocks have stood one Night, if nothing hinder, let them double, treble, or quadruple the Cocks, according as all Circumstances require, in this manner; *viz.* Spread Two, Three, or more, together, in a fresh Place; and after an Hour or Two turn them, and make that Number up into one Cock; but when the Weather is doubtful, let not the Cocks be thrown or spread, but enlarge them, by shaking several of them into one; and thus hollowing them to let in the Air, continue increasing their Bulk, and diminishing their

Number daily, until they be sufficiently dry to be carried to the Rick.

This I have found the most secure Way: Tho' it be something longer in making, there is much less Danger than when a great Quantity of Hay is spread at once; for then a sudden Shower will do more Harm to one Acre of that, than to Twenty Acres in Cock.

And the very best Hay I ever knew in *England*, was of *St. Foin* made without ever spreading, or the Sun's shining on it. This Way, tho' it be longer ere finish'd, is done with less Labour than the other.

Not only a little Rain, but even a Mist, will turn *Clover Hay* black; but *St. Foin* will not with any Weather turn black, until it be almost rotten, its Leaves being thinner than those of *Clover*.

If *St. Foin* be laid up pretty green, it will take no Damage, provided it be set in small round Ricks, with a large Basket drawn up in the Middle of each, to leave a Vent-hole there, thro' which the superfluous Moisture of the Hay transpires.

As soon as its Heating is over, these Ricks ought to be thatch'd; and all *St. Foin* Ricks, that are made when the Hay is full dry'd in the Cocks, ought to be thatch'd immediately after the making them.

That which is laid up most dry'd, will come out of the Rick of a green Colour, that which has much heated in the Rick, will have a brown Colour.

The Seed is a Fourth Chance the Owner has to make Profit of his *St. Foin*: But this, if the *Hoeing-Husbandry* were general, would not be vendible in great Quantities for planting; because an ordinary Crop of an Acre will produce Seed enough to drill an Hundred Acres, which would not want replanting in a long Time.

The other Use then of this Seed is for Provender; and it has been affirm'd by some, who have made Trials of it, that Three Bushels of good *St. Foin* Seed

Seed given to Horses, will nourish them as much as Four Bushels of Oats. When well order'd, it is so *sweet*, that most Sorts of Cattle are greedy of it. I never knew so much of it given to Hogs, as to make them become fat Bacon; but I have known Hogs made very good Pork with it, for an Experiment; and being valued at the Beginning of their feeding, and the Pork by the Score when the Hogs were kill'd, which, computed with the Quantity of Seed they eat, did not amount to near the Value of the same Seed sold for sowing; that being Three Shillings *per* Bushel, and the Profit made by giving it to the Hogs was but Two Shillings a Bushel.

The Goodness of the Seed, and of the Hay out of which it is thresh'd, depends very much upon the manner of ordering them.

This thresh'd Hay, when not damaged by wet Weather, has been found more nourishing to Horses than coarse Water-meadow Hay; and, when 'tis cut small by an Engine, is good Food for Cattle, and much better than Chaff of Corn.

It requires some Experience in it, to know the most proper Degree of Ripeness, at which the seeded *St. Foin* ought to be cut; for the Seed is never all ripe together; some Ears blossom before others; every Ear begins blossoming at the lower Part of it, and so continues gradually to do upward for many Days; and before the Flower is gone off the Top, the Bottom of the Ear has almost fill'd the Seeds that grow there; so that if we should defer cutting until the top Seeds are quite ripe, the lower, which are the best, would shed, and be lost.

The best time to cut is, when the greatest Part of the Seed is well fill'd, the first-blown ripe, and the last blown beginning to be full.

The natural Colour of the Kernel, which is the real Seed, is grey or bluish when ripe; and the Husk, which contains the Seed is, when ripe, of a brownish

Colour. Both Husk and Seed continue perfectly green for some time after full-grown; and if you open the Husk, the Seed will appear exactly like a green Pea when gather'd to boil, and will, like that, easily be split into Two Parts. Yet St. Foin Seed in this green Plight will ripen after Cutting, have as fine a Colour, and be as good in all Respects, as that which was ripe before Cutting: Some, for want of observing this, have suffer'd their Seed to stand so long, till it was all ripe, and lost in Cutting.

St. Foin Seed should not be cut in the Heat of the Day, whilst the Sun shines out: for then much, even of the unripe Seed, will shed in Mowing: Therefore, in very hot Weather, the Mower should begin to work very early in the Morning, or rather in the Night; and when they perceive the Seed to shatter, leave off, and rest till towards the Evening.

After Cutting we must observe the same Rule as in mowing it; *viz.* not to make this Hay whilst the Sun shines.

Sometimes it may, if the Seed be pretty ripe, be cock'd immediately after the Scythe; or if the Swarths must be turn'd, let it be done whilst they are moist; not Two together, as in the other Hay aforementioned. If the Swarths be turn'd with the Rake's Handle, 'tis best to raise up the Ear-sides first, and let the Stub-side rest on the Ground in turning; but if it be done by the Rake's Teeth, then let them take hold on the Stub-side, the Ears bearing on the Earth in turning over. But 'tis commonly Rain that occasions the Swarths to want Turning (*a*).

If it be cock'd at all (*b*), the sooner 'tis made into Cocks, the better; because, if the Swarths be dry,

(*a*) If the Swarths be not very great, we never turn them at all, because the Sun or Wind will quickly dry them.

(*b*) Sometimes when we design to thresh in the Field, we make no Cocks at all, and but only just separate the Swarths in the

dry, much of the Seed will be lost in separating them, the Ears being entangled together. When moist, the Seed sticks fast to the Ear; but, when dry, will drop out with the least Touch or Shaking.

There are Two ways of threshing it, the one in the Field, the other in the Barn: The first cannot be done but in very fine Weather, and whilst the Sun shines in the Heat of the Day: The best Manner of this is, to have a large Sheet pegg'd down to the Ground, for Two Men with their Flails to thresh on: Two Persons carry a small Sheet by its Corners, and lay it down close to a large Cock, and, with Two Sticks thrust under the Bottom of it, gently turn it over, or lift it up upon the Sheet, and carry and throw it on the great Sheet to the Threshers; but when the Cocks are small, they carry several at once, thrown upon the little Sheet carefully with Forks; those which are near, they carry to the Threshers with the Forks only. As fast as it is thresh'd, one Person stands to take away the Hay, and lay it into an Heap: And sometimes a Boy stands upon it, to make it into a small Rick of about a Load. As often as the great Sheet is full, they riddle it thro' a large Sieve to separate the Seed and Chaff from the broken Stalks, and put it into Sacks to be carried into the Barn to be winnow'd.

Two Threshers will employ Two of these little Sheets, and Four Persons in bringing to them; and when the Cocks are thresh'd, which stand at a considerable Distance all round them, they remove the Threshing-sheet to another Place. There belong to a Set for one Threshing-sheet Seven or Eight Persons; but the Number of Sheets should be according to the

the Dew of the Morning dividing them into Parts of about Two Feet in each Part. By this means the St. Foin is sooner dry'd, than when it lies thicker, as it must do, if made into Cocks.

Quantity to be thus thresh'd: The sooner these thresh'd Cocks are remov'd, and made into bigger Ricks, the better; and unless they be thatch'd, the Rain will run a great Way into them, and spoil the Hay; but they may be thatch'd with the Hay itself, if there be not Straw convenient for it.

But the chiefest Care yet remains; and that is, to cure the Seed: If that be neglected, it will be of little or no Value (*a*); and the better it has escap'd the Wet in the Field, the sooner its own Spirits will spoil it in the Barn or Granary. I have known it lie a Fortnight in Swarth, till the wet Weather has turn'd the Husks quite black: This was thresh'd in the Field, and immediately put into large Vessels, holding about Twenty Bushels each. It had by being often wet, and often dry, been so exhausted of its fiery Spirits, that it remain'd cool in the Vessels, without ever fermenting in the least, till the next Spring; and then it grew as well as ever any did that was planted.

But of Seed thresh'd in the Field, without ever being wetted, if it be immediately winnow'd, and a single Bushel laid in an Heap, or put into a Sack,

(*a*) But there is yet another Care to be taken of St. Foin Seed, besides the curing it; and that is, to keep it from Rats and Mice after 'tis cured; or else, if their Number be large, they will in a Winter eat up all the Seed of a considerable Quantity, leaving only empty Husks, which to the Eye appear the same as when the Seeds are in them. A Man cannot without Difficulty take a Seed out of its Husk; but the Vermin are so dextrous at it, that they will eat the Seed almost as fast out of the Husks, as if they were pulled out for them. I saw a Rat killed as he was running from an Heap of it, that had Seven peeled Seeds in his Mouth not swallowed; which is a Sign, that he was not long in taking them out. They take them out so cleverly, that the Hole in the Husk shuts itself up when the Seed is out of it. But, if you feel the Husk between your Finger and Thumb, you will find it empty. Also a Sackful of them is very light; yet there have been some so ignorant and incurious as to sow such empty Husks for several Years successively; and none coming up, they concluded their Land to be improper for St. Foin.

it will in few Days ferment to such a Degree, that the greatest Part of it will lose its vegetative Quality: The larger the Heap, the worse: During the Fermentation it will be very hot, and smell sour.

Many, to prevent this, spread it upon a Malt-Floor, turning it often; or, when the Quantity is small, upon a Barn-floor; but still I find, that this Way a great deal of it is spoil'd; for it will heat, tho' it be spread but an handful thick, and they never spread it thinner: Besides, they may miss some Hours of the right times of turning it; for it must be done very often; it should be stirr'd in the Night as well as the Day, until the Heating be over; and yet, do what they can, it never will keep its Colour so bright as that which is well hous'd, well dry'd, and thresh'd in the Winter: For in the Barn the Stalks keep it hollow; there are few Ears or Seeds that touch one another; and the Spirits have room to fly off by Degrees, the Air entering to receive them.

The only Way I have found to imitate and equal this, is to winnow it from the Sheet; then lay a Layer of Wheat-straw (or if that be wanting, of very dry-thresh'd Hay); then spread thereon a thin Layer of Seed, and thus *Stratum super Stratum*, Six or Seven Feet high, and as much in Breath; then begin another Stack; let there be Straw enough, and do not tread on the Stacks; by this means the Seed mixing with the Straw, will be kept cool, and come out in the Spring with as green a Colour as when it was put in, and not one Seed of a Thousand will fail to grow when planted. A little Barn-room will contain a great Quantity in this Manner.

I have had above One hundred Quarters of clean Seed thus manag'd in one Bay of a small Barn. We do not stay to winnow it clean before we lay it up in the Straw; but only pass it through a large Sieve, and with the Van blow out the Chaff, and winnow it clean in the Spring.

This Field-threshing requires extraordinary fine Sun-shiny Weather, which some Summers do not afford at the Season, for threshing a great Quantity of it; for 'tis but a small Part of the Day in which the Seed can be thresh'd clean out. They who have a small Quantity of it, do carry it into a Barn early in the Morning, or even in the Night; whilst the Dew is on it; for then the Seed sticks fast to the Ear: As it dries, they thresh it out; and if they cure it well, have thus sometimes good Seed, but generally the Hay is spoil'd.

There is one Method of saving all the Seed good, and the Hay too, by carrying it unthresh'd to the Barn or Rick, in a particular Manner, tho' it be a great Quantity, more than can presently be thresh'd; but must be laid up in Mows or Ricks, as Corn is. Then if it be carry'd in, in the Dews or Damp, the Hay is sure to be spoil'd, if not both Hay and Seed: When 'tis taken up dry, the Seed comes out with a Touch, and the greatest Part is lost in pitching up the Cocks, binding and jolting in carrying home.

To avoid this Dilemma, a Person who happen'd to have a great Crop of Seed on One hundred and Fifty Acres together (and being by Weather delay'd 'till Wheat-harvest came on, so that most Labourers went to Reaping) was forc'd to a Contrivance of getting it in as follows; viz: Three Waggons had each a Board with an Hole in, fix'd cross the Middle of each Waggon, by Iron Pins, to the Top of the Rades or Sides: There was a Crane which a Man could lift, and set into the Hole in the Board, and, having an Iron Gudgeon at the Bottom, which went into a Socket in the Bottom of the Waggon, would turn quite round: The Post of the Crane was Ten Feet Four Inches long, its Arm Four Feet Eight Inches long, brad'd; having a treble Pulley at the End of it, and another to answer it with an Hook.

About

About Forty Sheets were provided, capable of holding each One hundred and Fifty, or Two hundred Pounds Weight of it; these had Knots or Buttons at the Corners and Middles, made by sewing up a little Hay in these Knots, as big as Apples, into Part of the Sheet; for if any Buckle, or other thing, be sew'd to a Sheet plain, it will tear the Sheet. Half these Buttons have Strings ty'd to them; these Sheets are spread among the Cocks, fill'd by Two, and ty'd up by Two other Persons: There is also a light Fir Ladder, wide at Bottom, the Top of it fasten'd by a Piece of Cord to the brace of the Crane: they hitch the Hook of the lower Pulley to a fill'd Sheet, and by a little Horse at the End of the Pulley-rope, draw it up sliding on the Ladder; 'tis up in a Moment: Then the Man who is below, hitches the Crook of the Pulley to the lower Round of the Ladder, and the Loader above pulls up the Ladder from the Ground, till the Waggon comes to another Sheet. The Waggon is lengthen'd by Cart-Ladders before and behind, for the more easy placing of the Sheets. When about Twelve or Fifteen of them are loaded, they have a Rope fix'd to the Fore-part of each Waggon, which they bring over the Top of all the loaded Sheets, and wrest it at the Tail, to hold on the Sheets fast from falling off with Jolting. Then the Loader pulls out the Crane, and puts it into the next Waggon in the same Manner. One Waggon is loading whilst another is emptying in the Barn, by treble Pulleys likewise; because 'tis inconvenient to take it out of the Sheets by Prongs; but the Pulleys will easily draw off Two or Three Sheets together. One Waggon is always going to the Field, or coming home. This Contrivance makes more Expedition than one would imagine: Three Loads have been loaded, and sent off, in the same Time this way, that one Load of Hay has been loading, binding, and raking off the Out-

sides of it, in the next Ground, in the common Way.

I will not relate the manner of making a Rick of this Seed in its Hay, of monstrous Dimensions, by a sort of Mast-pole Forty-four Feet high, with a Ten Feet Crane at the Top, which made the same Expedition; because I think, that where such a Quantity is, *Dutch* Barns with moving Roofs are better. Such a Rick is troublesome to thatch, and the Wind has more Power to blow the Thatch off so high in the Air, than if it were lower. Neither would I advise any one to reserve much more St. Foin for Threshing, than his Barn will contain; because tho' sometimes it brings the greatest Profit by Threshing, yet some Years 'tis apt to be blighted.

I have been told by my Neighbour, that he had a Crop of Five Quarters of St. Foin Seed on an Acre; but the most Profit that ever I took notice of, was on half an Acre, which was drill'd very thin, and had no Crop of Corn with it; by which Advantage it produc'd a good Crop of Seed the next Year after it was planted, and the Third Year this Half-Acre produc'd (as was try'd by a Wager) within a Trifle of Two Quarters of Seed, which was sold for Two Pounds and Ten Shillings: The thresh'd Hay of it was sold in the Place for One Pound, and Two Quarters of Chaff sold for Twelve Shillings; in all Four Pounds and Two Shillings. There was also a very good Afermath, which was worth the Charges of Cutting and Threshing: So that the clear Profit of the One Year of this Half Acre of Ground amounted to Four Pounds Two Shillings: And it was remarkable, that at the same Time the rest of the same Field, being in all Ten Acres, had a Crop of Barley sown on Three Plowings, which (the Summer being dry) was offered to be sold at One Pound *per* Acre.

I believe

I believe the greatest Part of the St. Foin that is sown, is spoil'd by being indiscreetly fed by Sheep (*b*); which Damage is occasion'd merely by suffering them to continue feeding it too long at a Time, especially in the Spring; for then the Sap moves quick, and must be depurated by the Leaves; and as the Sun's nearer Approach accelerates the Motion or Ferment of the Juices, more *Pabulum* is receiv'd by the Roots; but for want of Leaves to discharge the Re-crements, and enliven the Sap with nitro-aereous Particles (the Sheep devouring the Buds continually as fast as they appear), the St. Foin's vital Flame (if I may so call it) is extinguish'd; the Circulation ceasing, the Sap stagnates, and then it ends in Corruption (*c*). But let the Sheep eat it never so low, in a short time, without continuing thereon, or cropping the next Buds which succeed those they have eaten, the Plants will recover and grow again as vigorously as ever, and if with a Spade, in the Winter you cut off the St. Foin Heads an Handful deep, and takethem away, together with their upper Earth, the Wound in the remaining Root will heal, and send out more Heads as good as those cut off, if those second Heads be preserv'd from Cattle, until they attain to a Bigness competent to bear Leaves suffi-

(*b*) I never suffer Sheep to come upon St. Foin, except betwixt Mowing-time and *All-Saints*. And there is so much Danger of spoiling St. Foin by the Fraud of Shepherds, that I knew a Gentleman that bound his Tenant never to suffer any Sheep to come thereon; and by this means his St. Foin continued in Perfection much longer than is usual, where St. Foin is suffer'd to be fed by Sheep.

(*c*) Natural Grass is not kill'd by constant feeding, because no sort of Cattle can bite it so low as to deprive it of all its Leaves; and 'tis, like Eels, more tenacious of Life than the rest of its Genius, and will send out Leaves from the very Roots when reverfed, as is too often seen where tuffy Land is plow'd up in large Furrows.

cient for the Use of the reviving Plants: Nay, I have seen Plants of St. Foin cut off in the Winter a Foot deep, and the Earth of that Depth taken away; and the remaining Root recover'd, and grew to an extraordinary Bigness: But this was preserv'd from Cattle at first.

I esteem St. Foin to be much more profitable than Clover, because St. Foin is never known to do any perceivable Damage to the Corn amongst which 'tis planted; but Clover often spoils a Crop of Barley (a); and I have known, that the Crop of Barley has been valued to have suffer'd Four Pounds *per* Acre Damage by a Crop of broad Clover's growing in it in a wet Summer: In a dry Summer both Sorts of Clover are apt to miss growing; and if it does grow, and the next Summer (wherein it ought to be a Crop) prove very dry, it fails on most sorts of Land, tho' it was vigorous enough to spoil the Barley the Year it was sown; at best, 'tis of but very short Duration, and therefore is not to be depended on by the Farmer, for maintaining his Cattle, which the broad Clover will also kill, sometimes by causing them to swell, unless great Care be taken to prevent it. The broad Clover is esteem'd a foul Feed for Horses. The Hop Clover is gone out of the Ground sooner than the broad Clover; I never knew it cut more than once: Indeed Cattle are never swollen by feeding on it; but then it affords but very little Feeding for them, except the Land whereon it grows be very rich.

St. Foin is observ'd to enrich whatever Ground 'tis planted on, tho' a Crop be taken off it yearly.

(a) But this Damage may be prevented by drilling the Clover after the Barley is an Handful high or more; for then the Barley will keep it under, and not suffer it to grow to any considerable Bigness till after Harvest; nor will this Drill, being drawn by Hand, do any Damage to the Barley.

Poor Slate Land (*a*), when it has borne sown St. Foin for Six or Seven Years, being plow'd up, and well till'd, produces Three Crops of Corn; and then they sow it with St. Foin again.

Rich arable Land was planted with it, and mow'd annually with very great Crops (*twas drill'd in Nine-inch Rows, with Six Gallons of Seed to an Acre; One Crop of it was sold at Four Pounds *per* Acre): This, after about Seven Years, and in full Perfection, was plow'd up by a Tenant, and continued for many Years after so rich, that, instead of dunging or fallowing it for Wheat, they were forc'd to sow that upon Barley-stubble, and to feed the Wheat with Sheep in the Spring, to prevent its being too luxuriant.

But 'tis to be noted, that the Land must be well till'd at the breaking up of old St. Foin, or else the First Crops of Corn may be expected to fail: For I knew a Tenant, who, the last Year of his Term, plow'd up a Field of St. Foin, that would have yielded him Three Pounds *per* Acre; but, thinking to make more Profit of it by Corn, he sow'd it with White Oats upon once Plowing; and it proving a dry Summer, he lost his Plowing and Seed; for he had no Crop of Oats, and was forc'd to leave the Land as a Fallow to his Successor.

Many more Instances there are of this Failure of the Crop of Corn after St. Foin has been broken up, and not well till'd.

(*a*) The Poverty of this sort of Land, lying upon Slate or Stone, generally proceeds from the Thinness of it; and, if it were thicker, it would be good Land: Much of this Earth, being dispersed among the Crannies or Interstices of the Slate and Stone to a great Depth, is reach'd by the Tap-roots of the St. Foin, but cannot be reach'd by the Roots of Corn; and therefore, when constantly kept in Tillage, is of small Value: Upon which Account such Land is greatly improveable by St. Foin, even when sown in the common manner.

When St. Foin is grown old, and worn out, as 'tis said to be when the artificial Pasture is gone, and the natural Pasture is become insufficient for the Number of Plants that are on it, to be maintained; and is so poor, that it produces no profitable Crop, so that the Ground is thought proper to be plow'd up, and sown with Corn, in order to be replanted (a); the most effectual Way to bring it into Tilth speedily, is, to plow it up in the Winter, with a Four-coulter'd Plough, and make it fit for Turneps by the following Season; and if the Turneps be well ho'd, and especially if spent by Sheep on the Ground, 'twill be in excellent Order to be sown with Barley the following Spring; and then it may be drill'd with St. Foin amongst the Barley.

To return to the Benefit Land receives by having been planted some Years with St. Foin: All the Experienc'd know, that Land is enriched by it; but they do not agree upon the Reason why.

They agree as to the *Ὅτι*, but not the *Διότι*.

Some are of Opinion, 'tis because the St. Foin takes a different Sort of Nourishment to that of

(a) Or if you perceive, that there is a competent Number of Plants alive, and tolerably single; be they never so poor, you may recover them to a flourishing Condition in the following manner, without replanting; Pulverize the whole Field in Intervals of about Three Feet each, leaving betwixt every Two of them Four Feet Breadth of Ground unplow'd. When the Turf of these Intervals, being cut by the Four coulter'd Plough, is perfectly rotten, one Furrow made by any sort of Plough will hoe one of these Intervals, by changing the whole Surface of it. The poorer the Land is, the more Hoings will be required; and the sooner 'tis ho'd, with proper Intermittions the first Year, the stronger the St. Foin will become, and the more Years it will continue good, without a Repetition of Hoing.

The Expence of this cannot be great; because the Plough, in hoeing an Acre in this manner Nine Times, travels no farther than it must to plow an Acre once in the common Manner.

I need not tell the Owner, that the Earth of these Intervals must be made level, before the St. Foin can be mowed.

Corn: But that I think is disprov'd in the Chapter of *Change of Species*, where 'tis shewn, that all Plants in the same Soil must take the same Food.

Mr. *Kirkham* thinks St. Foin has no collateral or horizontal Roots in the upper Part of the Ground where the Plough tills for Corn; and therefore has no Nourishment from that Part of the Soil which feeds the Corn. This would be a very good Account for it, were it not utterly contrary to Matter of Fact, as every one may see.

But so far it is right, that large (a) St. Foin draws the greatest Part of its Nourishment from below the Reach of the Plough; and what Part it does receive from the Staple is overbalanc'd by the Second Crop, or After-lease, being spent by Cattle on the Ground; different from Corn, which is very near wholly maintain'd by the plow'd Part of the Earth, and is all carry'd off.

For tho' the under *Stratum* of Earth be much poorer than the upper; yet that, never having been drain'd by any sort of Vegetables, must afford considerable Nourishment to the First that comes there.

And besides, in such Land whose Poverty proceeds from the Rain's carrying its Riches too quickly down through the upper *Stratum*, the under *Stratum* must be the richer (b) for receiving what the upper *Stratum* lets pass unarrested.

(a) For large St. Foin, being single, has large Roots, and very long, which probably descend Twenty Feet deep: Now, if we allow Four or Five Inches the Depth of the Staple, to afford a Supply equal to Two Feet below it, taking the lower Nineteen Feet Seven Inches together, upon this Computation, the Part below the Staple gives the St. Foin about Nine Parts in Ten of its Suttenance.

(b) In light poor Land the Water carrying some impregnated Earth along with it down lower than it does in strong Land, that is more tenacious or such impregnated Particles, the under *Strata* of strong Land are likely to be poorer than those of light Land.

'Tis well known, that many Estates have been much improv'd by St. Foin; therefore there is no occasion to mention Particulars. Only I will take Notice, that the Firſt in *England* was one of about One hundred and Forty Pounds *per Annum*, ſown with St. Foin, and ſold for Fourteen Thouſand Pounds; and as I hear, continues, by the ſame Improvement, ſtill of the ſame Value. This is, I ſuppoſe, the ſame that Mr. *Kirkham* mentions in *Oxfordſhire*.

Another Farm of Ten Pounds *per Annum* Rent, which, whiſt in Arable (*a*), was like to have undone the Tenant; but being all planted with St. Foin by the Owner, was lett at One hundred and Ten Pounds *per Annum*, and prov'd a good Bargain.

If it ſhould be ask'd, Why St. Foin is an Improvement ſo much greater in *England*, than in other Countries? it might be answer'd by ſhewing the Reaſon why *Engliſh* Arable is of ſo much leſs Value than Foreign (*b*) where the Land is of equal Goodneſs, and the Corn produc'd of equal Price.

C H A P. XIII.

Of LUSERNE.

L *A Luſerne* is that famous *Herba Medica* ſo much extoll'd by the Antients.

The high Eſteem they had of its Uſe appears by the extraordinary Pains they beſtow'd on its Culture.

(*a*) Theſe Estates conſiſted of thin Slate Land; which before it was planted with St. Foin, was valued at two Shillings *per Acre*, and ſome Part of it at One Shilling *per Acre* (as I have been inform'd); and yet Oxen are well fatt'd by the St. Foin it produces.

(*b*) 'Tis doubtleſs from the extraordinary Price of *Engliſh* Labour above that of other Countries, occaſioned by *Engliſh* Statutes being in this Reſpect different from all other Laws in the World.

Its Leaves resemble those of Trefoil: It bears a blue Blossom very like to double Violets, leaving a Pod like a Screw, which contains the Seeds about the Bigness of broad Clover, tho' longer, and more of the Kidney-shape.

The Stalks grow more perpendicular than any of the other artificial Grasses that I know, slender, full of Knots and Leaves: 'Tis of very near an equal Bigness from Bottom to Top: When cut, if vigorous, the Stalks will spring out again from the Stubs, immediately below where the Scythe parted them; which makes them the sooner ready for another Mowing; an Advantage which no other Grass has.

It has a Tap-root that penetrates deeper into the Bowels of the Earth, than any other Vegetable she produces.

Tho' one Luferne-root be much more taper than another towards the upper Part of it, 'tis sometimes seen, that a single ho'd Plant of it has many of these perpendicular Roots, some of them springing out from the very Branches of its Crown.

Its Roots are abundantly longer than the Roots of St. Foin: I have One that measures very near Two Inches Diameter: Those which are higher than the Ground have a Bark like a Tree. Upon this account, and by its Stalks springing again just below the Place where cut off, and by the woody Hardness of its Stalks, when they stand too long without cutting, it seems that Luferne is of a Nature nearly approaching to that of a Shrub.

Luferne is the only Hay in the World that can pretend to excel or equal St. Foin. I have known Instances of the pinguefying Virtue of this *Medica Hay*, that come up to the highest Encomiums given it by the *Romans*; which being to the Vulgar incredible, I forbear to relate, but leave to be confirm'd by the Experience of others, when it becomes frequent in *England*.

Luserne in Grass is much sweeter than St. Foin, or any other artificial or natural Grass. This, when ho'd, may be given to Cattle cut green, for Six Months; but then Care must be taken to (a) prevent their Swelling by its Lusciousness, and not to give them too much at once, until they be accustom'd to it.

The Quantities of Luserne Seed annually imported, and sown without Success, not discouraging People from continuing its Importation, shews there is more need of a successful Way of Planting, than recommending it in *England*.

I shall take Notice of some of the Reasons why I conclude there is no Hope of making any Improvement by planting it in *England*, in any manner practis'd by the Antients or Moderns.

I wonder how any one should attempt to plant it here, who has seen in *Columella*, and other Authors, the Description of the manner the old *Romans* planted it in. They chose out the very best Land, that was both *pinguis* and *putris*; they dung'd and till'd it to the greatest Perfection, and laid it out in Beds, as we do for Onions or Asparagus; they sow'd it

(a) The Swelling of Cattle by eating too much green Luserne, Clover, or Turnep-leaves, happens only to such as chew the Cud, because they swallow more in less Time than other Cattle do; and a large Quantity of such luscious Greens being swallow'd by a Beast, fermenting to a great Degree, heats and rarifies the internal Air, which by its Spring becoming too strong for that Column of the Atmosphere that enters at the Trachea, it presses the Lungs against the Thorax so closely, that the Weight of the external Column is not of Force to open their Vesicles, and then the Circulation of the Blood is stop'd, and the Beast is strangled.

Most Farmers know how to prevent the Swelling, so that nowadays it seldom happens; but when it does, there is an effectual way of curing it, if taken in Time: They cut a Hole into the Maw near the Back in a proper manner, whereat the ruffled Air rushes out, and the Lungs again perform their Action of Respiration.

very thick, for that miserable Reason of enabling it by its Thickness the better to kill the Grass. The Beds being harrow'd very fine before Sowing, which was in the End of *April*; the Seed required to be speedily cover'd, lest the Sun's Heat should spoil it. But with what Instrument must it be cover'd? For, after Sowing, the Place must not be touch'd with Iron. *At medica obruitur non aratro, sed ligneis rastellis.* 'Medica-seed is cover'd, not with the Plough, but with little (or rather light) wooden Harrows.' Two Days Work (of a Team) were spent on this Harrowing of one Acre. Some time after it came up, they scratch'd it again and again with the same wooden Instruments: This was call'd Sarrition: Then by Runcation they weeded it over and over, *Ne alterius generis herba invalidam medicam perimat.* 'Lest other Grass should kill it whilst it was weak.' The First Crop they let stand till some of the Seed shatter'd, to fill the Ground yet fuller of Plants: After that they might cut it as young as they pleas'd; but must be sure to water it often after cutting. Then after a few Days, when it began to spring, they repeated their Runcation: and so continuing to weed out all manner of Grass for the First Two or Three Years, it used to bring Four or Six Crops a Year, and last Ten Years.

English Gardeners make Forty Pounds of an Acre of Asparagus, or Cabbage-plants, with half the Labour and Expence that was bestow'd on an Acre of *Roman Medica*.

We know not the Price Hay and Grass were at in *Italy*, while the *Roman Empire* was in its Glory, and *Rome*, then the Metropolis of the World, drew the Riches of all Parts thither; its Price must be then very high.

And the *Romans* had not only Servants, but plenty of Slaves, for whom they had scarce sufficient Employment: This might lessen the Expence of this

tedious Method of Planting, and ordering the *Medica*. But when the *Romans* were brought down to the Level of other Nations, and in Danger of being Slaves, instead of having them; and the Lands of *Italy* came to be cultivated by *Italian* Hands only; they found something else more necessary to employ them in, than the Sarritions, Runcations, and Rigations of the *Medica*. Their Labour being bestow'd in getting Bread for themselves, they substituted other artificial Grasses of more easy Culture, in the room of *Medica*, for the Food of their Cattle. They were so bigotted to all the Superstitions of their Ancestors, that they were content to lose the Use of that most beneficial Plant, rather than attempt to cultivate it by a new, tho' more rational Method, when they were become unable any longer to continue it by the old.

Thus, as I take it, Superstition has chased *Medica* from the *Roman* Territories, and so little of it is planted there, that beyond the *Alps* I could not find one whole Acre of it.

Luserne makes a great Improvement in the South of *France*: There, when their low sandy Land is well prepar'd, and very clean, they sow it alone, in *March*, and at *Michaelmas*, as we do Clover: Their sowing it at those Seasons is of a double Advantage: First, it saves the Labour of watering it, which would be impracticable for so many thousand Acres, as there are planted. Secondly, Those Seasons being much moister than that wherein the *Romans* sow'd it, the Grub has Opportunity of eating more of it at its first coming up; and often the Frost kills some of it. By these Advantages the Ground is less overstock'd.

The Summers there are much drier than in *Italy*, so that the Sun scorches up the natural Grass, and suffers it not to come to a Turf till after some Years; and therefore has less need of Weeding.

But as that natural Grass increases, the Crops of Luferne are proportionably diminish'd: And tho' Luferne is said to last Ten or Twelve Years; yet it is in Perfection only for a very few Years. Whilst it is at best on their richest Land, and in a kind Summer, they have at Seven Crops Ten Tuns to an Acre, as I have computed them from the Relation of some of the Inhabitants of *Pezenas*. This was extraordinary: for I observ'd, that most of their common Crops made a very thin Swarth.

When the Ground begins to be turffy and hard, many of the Luferne-plants die, and the rest send up very few Stalks: The People know this is the Destruction of it, and therefore I have seen some of them, in that Case, half-plow it, thinking thereby to destroy the Turf: This does for a time much strengthen the Luferne-plants; but it so much strengthens the Grass also, that the Turf grows the stronger; and then there is no Remedy but to plow it up, make the Ground clean, and replant it.

In more Northern Climates, where it rains oftener, the Ground sooner becomes hard; and in the Land otherwise most proper for Luferne, the Grass grows infinitely faster, and will be as strong a Turf in Two Years, as in the hot Countries in Ten. Upon this Account, about *Paris*, even near the Walls, they plow up Luferne, and sow St. Foin in its room, because that endures Grass and hard Ground better, tho' it brings but One Crop a Year, or Two at most.

And in many Places in *Franche Comtè* and *Switzerland*, I have seen Luferne in the Corners of Vineyards, not above Two or Three Perches together, which they will at any Expence have to cure their Horses when sick; since they cannot obtain, by their Culture, Quantities sufficient to maintain them as their ordinary Food, there being too much Rain, and too little

of the Sun's violent Heat, to prevent the speedy Increase of Grass amongst it.

How then can we expect Success in sowing it in *England*, where Rains are yet more frequent, and the Sun is weaker? 'Tis not One Year in Ten, that the natural Grass is here scorch'd up. In our rich Land the Grass comes to a Turf very soon, and poor Land will not by the common Sowing bring Luserne to any Perfection, tho' no Grass should annoy it.

I have here seen Part of a Meadow Breast-plow'd, and, when the Turf was dead, dug up and planted as a Garden: After it had been drill'd with Carrots, ho'd, and made, in all Appearance, perfectly clean, it was sown with Luserne, which came up and flourish'd very well the First Year, and indifferently the Second; but, after that, the Grass came, and the Luserne grew faint; and in Three or Four Years time there was no more left, but just to shew by here-and-there a single poor Stalk, that there had been Luserne sown, except one Plant of it, which was cleansed of Grass the Third Year; and this recover'd, and sent up Abundance of Stalks for Two Years after it; and then the Grass returning, that Plant dwindled again.

I have often try'd it in the richest Part of my Garden, and constantly find, that, however vigorously it grows at the first, yet it soon declines, when the Grass appears amongst it, which is always the sooner, by how much the Soil (in *England*) is richer, unless the Spade or Hoe prevent it.

Here have been also many Fields of a poorer whiteish Soil sown with it, which are not very subject to be over-run with Grass, as the rich Land is; and tho' these were so well till'd as scarce any Grass appear'd, during the many Years the Luserne liv'd therein, yet it never grew to any Perfection here neither; nor was there any one Crop worth much more than the Cutting, it was always so poor, thin, and short. And, by what Intelligence I can get, all

Experience proves, that every Soil in this Island is too rich, too poor, or too cold, for the Luferne Improvement by the common Husbandry.

I believe every one will be confirmed in this, who shall upon full Inquiry find, that, amongst the great Quantities which have been sown in this Kingdom in that manner, never any of it was known to continue good and flourishing Three Years; and that, on the contrary, never any one Plant of it in any warm Soil, cultivated by the Hoeing manner, was known to fail here, or in any other Country, as long as the Hoeing (or Digging about it, which is equivalent) was continued to it with proper Repetitions.

A Multitude of such hoed Plants have I known, and are now to be seen in both poor and rich Lands: Therefore it seems possible, that Thousands of *English* Acres may be capable, by the Hoeing Culture, to produce Crops of Luferne every Year for an Age. For as the greater Moisture, and less intense Heat of this Climate, are, upon the Accounts mentioned, injurious to Luferne, yet this is only to such as is sown and cultivated in the common Manner, because our Climate, upon the very same Accounts, is very advantageous to hoed Luferne.

In hot Countries, when the Summer is drier than ordinary, the Sun so scorches it, that they have fewer and much poorer Crops, than in moister Summers; *viz.* only Four or Five, instead of Six or Seven; but, in the driest Summer I ever knew in *England*, hoed Luferne yielded the most Crops.

Our Summer Days are longer, have more of the Sun's Warmth, and lets of his fiery Heat; he cherishes, but never burns Luferne, or any other hoed long Tap-rooted Plant in *England*.

The well hoed Earth, being open, receives and retains the Dews; the benign solar Influence is sufficient to put them in Motion, but not to exhale them

from thence. The Hoe prevents the Turf, which would otherwise by its Blades or Roots intercept, and return back the Dews into the Atmosphere, with the Assistance of a moderate Heat. So that this Husbandry secures Luserne from the Injury of a wet Summer, and also causes the Rain-water to sink down more speedily, and disperse its Riches all the Way of its Passage; otherwise the Water would be more apt to stand on the Surface, chill the Earth, and keep off the Sun and Air from drying it: For, when the Surface is dry and open, Luserne will bear a very great Degree of Heat, or grow with a mean one. I have seen this hoed Luserne, in a sheltered Place of my Garden, so much grown in a mild Winter, as to be measured Fourteen Inches and an half high at *Christmas*; and a very large single Plant of it, which had not been hoed for Two Years before, was laid bare by digging out the Earth all around it a Foot deep, to observe the Manner of its Tap-root; and then the Earth was thrown in again, and the Hole filled up. This was on the Twenty-seventh of *September*. Upon this mellowing of the Soil about it, it sent out more Stalks in *October*, than it had done in the whole Summer before; they grew very vigorously, until a great Snow fell in *December*, which also preserved the Verdure of them, till that was melted away, and a black Frost came after it, and killed those Stalks. It is probable this Plant sent out immediately new fibrous horizontal Roots, which did grow apace to extract the Nourishment from this new-made Pasture, in proportion to the quick Growth of the Stalks, which in Summer have been measured, and found to grow in Height Three Inches and an half in a Night and a Day; this being almost One Inch in Six Hours.

And it has been my Observation, that this Plant, in hot and cold Countries, thrives both with a much greater, or less Degree of Heat and Moisture, when it is hoed; for if it has Plenty of Nourishment, which
Hoeing

Hoeing always gives it, a very little Heat above, and the Moisture alone (which is never wanting to the deep Tap-root) suffice, and that Plenty of Food enables it the better to endure the Extremes of either Heat or Cold.

We need not much apprehend the Danger of *English* Winters; for Luserne will endure those which are more rigorous. In the Principality of *Neuchâtel* the Winters are so severe, as to kill all the Rosemary left abroad; yet Luserne survives them there: This proves it more hardy than Rosemary, which is planted for Hedges in *England*; and here is scarce twice in an Age a Frost able to kill it.

I have one single Luserne-plant in a poor Arable Field, that has stood the Test of Two-and-twenty Winters, besides the Feeding of Sheep at all Seasons, and yet remains as strong as ever. What Quantity of Hay this Plant yearly produces, cannot be known, because at those times that Cattle are kept from it, the Hares constantly crop it, being sweeter than any other Grass.

But this happens to be fortunately situate, where 'tis not altogether destitute of the Benefit of Hoeing. 'Tis in an Angle, where, every time the Field is till'd, the Plough goes over it in turning from the Furrows of one Land and one Head-land; but it is after the Plough is lifted out of the Ground, and turned up on one side, so that the Share only breaks the Turf very small all around it, without plowing up the Plant: Yet it has escaped it so narrowly, that the Fin of the Plough-share has split it into Four Parts; Three of which remain, and grow never the worse, but the Fourth is torn off, and the Wound healed up.

By the extreme hard Winter that happened about the Year 1708, or 1709, some of the Luserne in *Languedoc* was killed: Yet this was no Argument of its Tenderness, but rather the contrary; because then all the Olive-trees and Walnut-trees were there killed, tho'

tho' the greatest Part of the Luserne escaped unhurt: And I did not hear one Walnut-tree was killed that Winter in *England*. Perhaps those in *France*, having being accustomed to much hotter Summers, were unable to endure the Rigour of the same Winter, that could do no Harm to the same Species in *England*, where our Winters do not seem to exceed some of theirs in Cold, so much as their Summers do ours in Heat. And since the Extremes are not so far asunder here, the same Degree of Cold may to our Plants seem tepid, which to those in *Languedoc* must seem rigorous, differing a more remote Degree from the opposite Extremity of Heat in Summer.

And, besides the Difference of Heat and Cold in different Climates, there is another more necessary to be observed; and that is, the Difference of the Hardiness in different Individuals of the same Species: The same Frost that kills a faint languishing Plant of Luserne, will be despised by a robust one, which, being well fed by the Hoe, becomes a Giant cloath'd and fenced with a thick Bark, that renders it impregnable against all Weather; its Rind is to it a Coat of Mail or Buff, impenetrable by Frost: But the unhoed is generally small and weak; its thin tender Bark exposes it almost naked to the Frost; it being, for want of a sufficient Pasture, starv'd and half-dead already, 'tis the more easily killed by the Cold.

I formerly lived some Years in *Languedoc*, where are many Hundred Acres of Luserne; and I never could find a very large Plant amongst it, unless in such Pieces as had been plowed up, tilled, and sown with Corn: Here indeed those Plants that remained (as always some would do) grew to an extraordinary Bulk; and One of those single tilled Plants did seem to produce a greater Quantity of Stalks, than Twenty of such as had not been plowed up; and as there were no large Plants amongst the unplowed, so there were no small amongst the plowed ones. The same thing
has

has been observed in all other Places where Luserne has been plowed (a).

And in *Wiltshire* several Grounds of it stood some Years without ever coming to a Substance to be of any Value, tho' the Land was whitish, and scarce any Grass appeared amongst the Luserne; and therefore its Poorness was thought to proceed from the Soil's being improper; but when it had been broken up, and sown several Years with Corn, and afterwards lain down with St. Foin, all the Luserne-plants which remained (and they were many) grew large and strong, shooting up a Yard in Height soon after the St. Foin was cut; and if there had been a competent Number of them undestroyed by the Plough, they would have yielded Crops of an extraordinary Value, where before Plowing it grew but few Inches above the Ground.

It seems that in this sort of Land the Earth grows stale, ere the Luserne arrives at a Tenth Part of its Stature: But this is most remarkable, that Tillage transforms those Luserne-plants from Dwarfs to Giants; and then they are able to contend with, if not conquer, so strong Plants as St. Foin is, tho' before Plowing they were unable to resist the Depredations of a few hairy Spires of Grass.

Since Tillage can thus recover Luserne, after it has long languished in the lowest Ebb of Life, and restore it to Health, Youth, and Vigour, and augment its Stature even after it has passed the Age of its full Growth; to what Bulk would it arrive, regularly planted, and hoed from its Infancy to Maturity without any Check to stint it!

We can never know how poor a Soil will bear this Plant, unless it be tried by the Hoeing Culture.

For 'tis wondrous how so great a Man as Dr. *Woodward* should imagine, that Difference of Soil

(a) This Plowing is a Hoeing to the Luserne.

should be the Reason why Apples in *Herefordshire*, and Cherries in *Kent*, succeed better than in other Places, when in truth they are seen to prosper as well almost all over *England*, where planted, cultivated, and preserved.

I believe Plants are more altered as to their Growth, by being cultivated or not, than by Change of Climates differing in very many Degrees of Latitude. I say, in their Growth, not always in their Fruit; for tho' a Peach-tree, well cultivated in a Standard, will grow here vigorously, and be very beautiful; yet its Fruit will be of little Value, unless it be planted against a good Wall: So *Luserne*, unless cultivated upon a well exposed Gravel, will yield little Seed in *England*.

The Soil to plant it on is either an hot Gravel, a very rich dry Sand, or some other rich warm Land, that has not an under *Stratum* of Clay, nor is too near the Springs of Water; for, if the Earth below be of a cold Nature, which I take to be occasioned by its holding of Water, the *Luserne* will not long prosper therein, of whatever Sort the upper *Stratum* of Earth may be: This may be guessed at by the Vegetables a Soil naturally produces, as Fern, and the like; which, Mr. *Evelyn* observes, do indicate a Soil subject to Extremities of Heat and Cold; and condemns such a Soil as accursed. I agree to that Sentence, as far as relates to Cold; but am not satisfied of its abounding with Heat; and I am sure I know some Land very subject to Fern, which is very far from being barren, when well cultivated, and well suited with Vegetables; but, from among these, *Luserne* must be excluded.

Luserne in hot Countries grows best near Rivers, where its Roots reach the Water, which helps to mitigate the excessive Heat of the Climate; but here the Heats are so moderate, that if *Luserne*-roots are in Water (for 'tis that that makes Earth cold) it dimi-

nishes too much the just Proportion of Heat, which Luserne requires.

The natural Poorness of an hot Gravel may be compensated by Dung, more Heat, and the Benefit of the Hoe.

The natural Richness of the other sorts of Land being increased by hoeing and cleansing it from Grass, Luserne will thrive therein with the less Heat; for what the Soil wants of one of these Two Qualities, must be made up with the other; and it has grown high in hoed rich Ground at *Christmas*, when that in Land of an hotter Nature, but poorer, has not been able to peep out, for want of more Nourishment: So, if rich Land be clayey, very wet and cold, tho' very rich, it requires much Heat, for as high a Growth of Luserne at *Midsummer*.

The best Season of planting it in *England* is in *April*, after the Danger of Frost is over; for a small Frost will destroy the whole Crop, when the Plants first appear; and too much Wet, with cold Weather, will rot the Seeds in the Ground; so that about the Middle of *April* may be generally esteemed as the best Season for sowing this Seed.

The hoed Plants of Luserne having larger Roots, and yielding more Crops than those of St. Foin, Reason seems to require, that the Number of the former be less.

But, on the other hand, if we consider, that as the Luserne-roots exceed the St. Foin in Bigness, so they also do in Length, by as great a Proportion; being generally less taper, and as they go deeper, they have more Earth to nourish them; they also require a better Soil, and more frequent Aids from the Hoe; and, by their extraordinary quick Growth, receive a speedier Relief from it, than the Roots of St. Foin do.

Thus, if by reaching deeper in a better Soil, and being more hoed, Luserne receives, from a square
Perch

Perch of Ground, Nourishment in a proportion double to that whereby its Roots exceed those of St. Foin in Bigness, then I do not see why we should not leave the Number of Luserne-plants double to the Number of those we leave in St. Foin.

But if the Excess of Nourishment were no more than the Excess of Bigness of Roots, I think an equal Number of Plants should be left in Luserne, and in St. Foin: Yet since the hot or cold Constitution of a Plant, and also the Quantity it can produce, ought to be considered, as well as its Bulk, in relation to the Nourishment it requires, more Trials are necessary for determining the exact Number of Luserne-plants proper to be placed on a square Perch, than have been hitherto made.

Perhaps it will be thought heterodox to maintain by any Arguments, that to err in falling somewhat short of the just Number, is not of worse Consequence, than exceeding it.

Where they stand at Four or Five Inches asunder in the Rows, 'tis observed, that tho' the Intervals betwixt the Rows be wide, yet the Plants are much the larger, and produce more that stand in the outside Rows (the Ground without being clean); and especially those at each End of the outside Rows, that is, the Corner-plants, are largest of all. I need not say, that had all the other Plants as much Room and Tillage as the Corner ones have, they would be as large, and produce each as much Hay; for those which stand perfectly single in Places by themselves, are seen to be larger, and produce more, than those Corner ones; and of the larger and longer Roots our Stock does consist, the more Nourishment they are capable of taking, as has been shewn. Where some Plants of the Luserne have been planted Two Feet asunder, in poor dry Land, which was kept clean from Weeds, and frequently digged, each Plant has sent forth upward of Three Hundred Stalks,
and

and these have been Six or Seven Inches high by the Middle of *March*.

And it must be likewise observ'd, that the Crop will be produc'd in Proportion to the Nourishment it receives; for if the most gigantic *Luserne* plant, which, when pamper'd by the *Hoe*, has made a Produce more like a *Tree* than an *Herb*, remains a few Years without that or some equivalent Culture, it will by little and little cease to produce more than a few poor sickly Stalks, just to shew its Species; and then, if this Culture be repeated, will recover its pristine Strength, and yield as great a Crop as ever; but, if that be longer omitted, will die: The Vastness of its Root avails nothing, unless it has Food in proportion to it.

Hence it appears, that the most fatal Disease incident to *Luserne* is starving, and that rarely suffers any of its Plants to arrive at the full Period of their Growth or Age; it prevents their Fertility even in the Prime of their Youth, and kills them before they have liv'd out Half, or perhaps the Tenth Part, of their Days. How long its Life might otherwise be, nobody knows, unless a Plant could be found to die when well fed; for when it is, 'tis so tenacious of Life, that, I am told, beheading will not dispatch it (*a*).

'Tis therefore necessary, that our Rows be plac'd at such a Distance, as that their Intervals may be wide enough for the *Hoe-plough* to raise an artificial Pasture, sufficient to sustain the Number of Plants in them.

Whoever shall make Trials of this Husbandry (for that is all I propose to others), I would advise them to begin with Rows that have Intervals of Thirty-three Inches; for, if they begin with much

(*a*) But I have cut off the Heads of some myself to try, and could not find that any one would sprout again, tho' *St. Foin* will; perhaps I tried at the wrong Season.

narrower Distances, they may be by that means disappointed of Success: But tho' they should afterwards find a Way to hoe them at somewhat nearer Distances; yet the Loss of a few Perches of Ground would not be much; neither can they be wholly lost, since the Roots of these Plants may be prov'd to extend much farther horizontally, than from Row to Row at that Distance. And the wider the Intervals are, the more Earth will be till'd in a Perch of Ground; because Six Rows, which will be therein at Thirty-three Inches Distance, will admit the Hoe-plough to till more Earth, than Nine Rows at Twenty-two Inches Distance from each other. And, besides, 'tis not proper, that every time of hoeing, the Plough should come very near to the Plants, unless when Grass comes amongst them; and then they may, in Thirty-three Inch Spaces, be perfectly cleansed in this manner: *viz.* Plow a good Furrow from each Side of every Row; and then with Harrows, or other Instruments proper for that Purpose, going cross them, you will pull out both Earth and Grass from betwixt the Plants; then, after a convenient Time, plow these Furrows back again to the Rows; this will in a manner transplant the upper Part of the Roots, and bury the Grass, tho' it be not dead, by lying open to be dry'd by the Sun: Then harrow the Ground to break it more, and to level it, and go once over it with a very light Roller, to the End that the Hay may be raked up the cleaner.

I am aware of the common Prejudice, which is, that People, when they have never seen a Plantation of these Plants in Perfection, are apt to form to themselves the Idea of such small ones as they have been used to see; and thence imagine it impossible that this (tho' a double) Number should be sufficient to make a Crop. But they might, with equal Reason, imagine the same of Apple-trees at a Year's Growth, which are less than these at the same Age;

and

and so plant a Thousand Trees in the Room proper for one. The Antients direct the Planting of Seventeen *Cytifus* Plants in a Perch of Ground; and I do not believe, that ever those Seventeen could yield a Crop equal to Two hundred Twenty-four Luserne-plants; for as many Ounces of Hay as each of these yields, so many Ton of Hay will one Crop of an Acre produce: Thus by weighing the Product of one Plant (supposing them all equal) the Quantity of the Crop may be determin'd, and prov'd greater than Fancy from their Number represents.

	s.	d.
April 14. One single unho'd Plant of Luserne had Thirty-one Stalks, which, by Silver-Money, weigh'd green —	23	0
24. The same dried to Hay, weigh'd	6	6
14. The Stalks of one single ho'd Luserne-plant green, weigh'd —	56	0
24. The same dry'd — — —	14	6
14. Eighteen Inches in Length of a Row, being five indifferent Plants, weigh'd green one Pound and an half <i>Avoirdupois</i>		
24. Dry'd to Hay, it weigh'd —	28	6
25. One Foot of an ho'd Row, being One hundred and Sixty-Stalks of two Luserne Plants of Six or Seven Years old, weigh'd Two Pound green —		
But the same dry'd, to the 9th of May, weigh'd no more than — — —	31	6

Which last is about Three Tons to an Acre.

This I am certain of, that the least competent Number of Plants will bring the greatest Number of Crops: since I see the Stalks of a single ho'd Plant grow higher in Fifteen Days, than one amongst near Neighbours does in Thirty Days.

The greatest Difference between the Culture of this and St. Foin is, that Luserne Rows should be more grown, before the Plants be made single in them by the Hand-hoe, lest the Fly should destroy some

afterwards, and then they might become too thin. For Luserne is sometimes eaten by the Fly, as Turneps are, tho' St. Foin be never liable to that Misfortune, if sown in a proper Season. Luserne must also be more frequently ho'd (a), in some Proportion to the more frequent Crops it produces.

I shall not go about to compute the Difference of Expence bestow'd in the *Roman* Culture and in this; yet it will appear theirs was incomparably more chargeable, and that the Excess of Charge was occasioned by their Error in the Theory of Husbandry.

They sow'd it so thick, that the Plants must needs be very small; and when Ten of them were no bigger than one good single ho'd Plant would have been, in the same Space of the Earth's Surface, they could have but a Ninth Part of the Earth's Depth, which the one would have had. The Defect of Depth must be therefore made up, in some Measure, by the extraordinary Richness of the Surface. Upon this Account few Lands were capable of bearing *Medica*. Their sowing it so late made the first Waterings necessary; and the Shortness of the Roots required the repeated Rigations, after the Crops were cut: For

(a) The Hoe-plough is the Instrument to bring it to Perfection: but then I doubt it must lie still some Years, lest the plow'd Earth injure the Hay that is made upon it; and when it is come to a Turf, and the Luserne wants renewing, the Four coulter'd Plough is the only Instrument that can prepare the Turf to be kill'd, and cure the Luserne; which Plough must be used in the following Manner: Turn its Furrows toward one Row, and from the next; that is, plow round one Row, and that will finish Two Intervals, and so on; and the next Plowing must be towards those Rows, from whence they were turn'd the first time; take care the first Furrows do not lie long enough on the Rows to kill the Plants, which will be much longer in Winter than in Summer. But you may leave every Third or Fourth Interval unhoed for making the Hay on, which will be yet more beneficial, if the Swarths in mowing should fall thereon. This unhoed Interval may be plow'd when there is Occasion, and another left in its stead,

Columella saith in *Lib. ii. Cap. 11. Cum feceris autem, sepius eam rigato.* But had it been cultivated by the hoeing Method, the Tap-roots would have descended as deep as a Well, and, from the Springs below, have sent up Water to the Plants, besides what the Hoe would have caused the horizontal Roots to receive from Dews at the Surface above. At how much a cheaper Rate Water is supply'd by these Means, than by carrying it perhaps a great Way, and then sprinkling it by Hand over the Beds, which were made Ten feet wide between Path and Path for that Purpose, let any one judge; as also what a laborious Task it was to pick out the Grass with Fingers from amongst it, in the hard dry Ground in the Summer, after mowing the Crop, as *Columella* directs in his foremention'd Chapter, which the Horse-hoe would have done with Ease, at a Twentieth Part of that Expence. However, since they saw the *Medica* was as impatient of Grass as the Vineyards were, 'tis a Wonder they did not give it the same Culture with the *Bidens*, which would have been much better and cheaper, than to cleanse the *Medica* with Fingers. Indeed Fingers were made before the *Bidens*; but sure the Effect of its Use in raising Juices to the Vine, had inspired the *Romans* with more judicious Speculations, than to give that for a Reason why they ho'd the *Medica* with their Fingers, rather than with the *Bidens*.

Oh! But this was made with Iron, and *Medica* had, in those Times, an Antipathy to Iron; and after it was sown, the Place must not be touch'd by that Metal; therefore the Seed must not be cover'd with a Plough, nor with Iron Harrows. But if they had made Trials enough, to know that half an Inch was a proper Depth to cover this Seed at, these *Virtuosi* would have been convinc'd, that it had no less Antipathy to these Instruments, of what Matter soever they were made, if they bury'd it Five or Six

Inches deep, which the Plough must do, and the Weight of Iron Harrows in such fine Ground not much less. Had the Plough been all of Wood, the Furrow would have lain never the lighter upon the Seed; and if the wooden Harrows had been loaded with a Weight capable of pressing it down as deep, it would have been no more able to rise, than if it had been buried with Iron Harrows: This *Columella* seems to be sensible of, when he says, *Rastellis lignis*; viz. That it was not sufficient for them to be made of Wood, unless they were diminutive; for then they were light ones. 'Tis probable the Plough suffer'd none to come up, and the heavy Harrows very few, tho' perhaps Plants enough, had they calculated what Number were sufficient: But unless the Ground were cover'd with them at first, it seems they had not Patience to wait till the Plants grew large enough, to fill it with a bare competent Number, and thought it not worth while to weed and water, what they fancied to be an insufficient Number. 'Twas expected that the Thickness of the Plants should help to kill the Grass: Yet upon due Observation 'tis found, that when their excessive Numbers have brought a Famine amongst them, they are forc'd to prey upon one another; and tho' the stronger survive, yet even those are so weaken'd by Hunger, that they become the less able to contend with Grass, whose good Fortune it was, that Superstition would not permit the *Romans* to interpose, by attacking it with Iron Weapons.

I hope these Hints may be improv'd for the Abolition of old Errors, and for the Discovery of new Truths; to the end that Luserne may be planted in a more reasonable Method than has been commonly practis'd: And when the Theory is true, 'tis impossible the Practice should be false, if rightly apply'd; but if it fail of Success, the Event will be a

Proof either of a Misapplication, or that the Theory is false.

Luserne should be order'd for Hay in the same Manner as is directed for St. Foin in the foregoing Chapter: But it must be observ'd, that Luserne is more worsted by being suffer'd to survive its Virginity before cutting; and therefore the richest and most nourishing Hay is cut whilst the Stalks are single, without any collateral Branches shooting out of them; and when they are so, neither Blossoms nor even their Buds appear. But of that sown in the old Fashion, the last Crops, for want of a new Supply of Nourishment, grow so slowly, that ere it is high enough to be cut, the Blossoms are blown out, and the Stalks, tho' very small, are become *woody, hard, and dry*, and make the Hay nothing near so nourishing as that of the first Crops.

But in that which is ho'd, the last Crops of it will, by virtue of the greater Quantity of Nourishment it receives, grow faster, and be of an Height fit to cut before blossoming, and thence being as young and vigorous, make as good Hay as the first Crops; so that Hoeing does not only procure more and larger Crops, but also better Hay.

This is most certain, that unless we can keep our Luserne pretty clean from natural Grass, we cannot expect it to succeed, let the Soil be never so proper.

C H A P. XIV.

Of Change of SPECIES.

- I. *That Plants of the most different Nature feed on the same Sort of Food.*
- II. *That there is no Plant but what must rob any other Plant within its Reach.*
- III. *That a Soil which is proper to one Sort of Vegetable once, is, in Respect of the Sort of Food it gives, proper to it always.*

IF any one of these *Three Propositions* be true, as I hope to prove all of them are, then it will follow, that there is no need to change the Species of *Vegetables* from one Year to another, in respect to the different Food the same Soil is, tho' falsely, supposed to yield (*a*).

The common Opinion is contrary to all these (as it must be, if contrary to any one of them): And since an Error in this fundamental Principle of *Vegetation* is of very ill Consequence; and since Dr. *Woodward*, who has been serviceable in other respects (*b*) to this Art, has unhappily fallen in with the Vulgar in this Point; his Arguments for this Error require to be answer'd in the first Place.

(*a*) For if all Plants rob one another, it must be because they all feed on the same Sort of Food; and, admitting they do, there can be no Necessity of changing the Species of them, from one Soil to another; but the same Quantity of the same Food, with the same Heat and Mouldure which maintains any Species one Year, must do it any other Year.

(*b*) By proving, in his Experiments, that Earth is the *Pabulum* of Plants.

The Doctor says (c) ‘ It is not possible to imagine
 ‘ how one uniform, homogeneous Matter, having its
 ‘ Principles, or original Parts, all of the same Sub-
 ‘ stance, Constitution, Magnitude, Figure, and Gr-
 ‘ vity, should ever constitute Bodies so egregiously
 ‘ *unlike*, in all those Respects, as Vegetables of dif-
 ‘ ferent Kinds are ; nay, even as the different Parts
 ‘ of the *same* Vegetable.

‘ That there should be that vast Difference in
 ‘ them, in their several Constitutions, Makes, Pro-
 ‘ perties, and Effects, and yet all arise from the very
 ‘ same Sort of Matter, would be very strange.’

Answer. ’Tis very probable, that the terrestrial
 Particles which constitute *Vegetables*, tho’ inconceiv-
 ably minute, may be of great Variety of Figure, and
 other Differences ; else they could not be capable of
 the several Ferments, &c. they must undergo in the
 Vessels of Plants. Their Smallness can be no Objec-
 tion to their Variety, since even the Particles of Light
 are of various Kinds.

But as the Doctor asserts, ‘ That each Part of the
 ‘ same *Vegetable* requires a peculiar specific Matter
 ‘ for its Formation and Nourishment ; and that there
 ‘ are very many and different Ingredients to go to the
 ‘ Composition of the same individual Plants ;’

From hence must be inferred, that the same Plant
 takes in very many and different Ingredients (and it
 is proved, that no Plant refuses any Ingredient (d)
 that is capable of entering its Roots. Tho’ the ter-
 restrial Particles which nourish *Vegetables*, be not
 perfectly homogeneous ; yet most of the various

(c) In *Philos. Transf.* No. 253.

(d) Dr. *Grew*, in his Anatomy of Plants, by microscopical
 Inspection, found, that the outer Superficies of Roots was of a
 spongy Substance ; and ’tis well known, that no such Body can
 refuse to imbibe whatever Liquor comes in Contact with it, but
 will by its springy Porosity absorb any sort of Moisture.

Tastes and Flavours of Plants are made in and by the Vessels (e).

Doctor *Woodward* says, ‘ That Water will pass
‘ Pores and Interstices, that neither Air, nor any
‘ other Fluid, will: This enables it to enter the finest
‘ Tubes and Vessels of Plants, and to introduce the
‘ terrestrial Matter, conveying it to all Parts of them;
‘ whilst each, by means of Organs ’tis endow’d with
‘ for the Purpose, intercepts, and assumes into itself,
‘ such Particles as are suitable to its own Nature (f);
‘ letting the rest pass on *through the common Ducts.*’

Here then he says plainly, That each Plant receives the terrestrial Matter in gross, both suitable and

(e) We are convinced, that ’tis the Vessels of Plants that make the different Flavours; because there is none of these Flavours in the Earth of which they are made, until that has enter’d and been alter’d by the vegetable Vessels.

(f) If the Doctor’s Plants were so nice in leaving vegetable Matter *behind, quiet and unaltered*, ’tis a Wonder they would take up the mineral Matter, as, he says, they did, that kill’d themselves with Nitre.

These Plants might, with much less Difficulty, have distinguish’d the mineral Matter from the vegetable Matter, than they could distinguish the different Particles of vegetable Matter from one another, and must have been very unwise to chuse out the Nitre (their Poison) from the Water and Earth, and to leave the vegetable Particles behind; none of which could be so improper to them as the Nitre.

It may perhaps be objected, that such like pernicious Matter kills a Plant by only destroying its Roots, and by closing the Pores; which prevents the Nourishment from entering to maintain its Life; and that such Matter doth not itself enter to act as Poison upon the Sap, or upon the Vessels of the Body, or Leaves: But it plainly appears that it doth enter, and act as Poison; for when some of the Roots of a Mint, growing in Water, are put into salt Water, it kills the whole Plant, although the rest of the Roots remaining in the fresh Water were sufficient to maintain it, if the other Roots had been cut off at the Time they were removed into the Salt Water; and also all the Leaves, when dead, will be full of Salt.

Or if the Juice of wild Garlick-seed be made use of instead of the salt Water, it will have the same Effect; and every one of the Mint-leaves will have a strong Taste of Garlick in it.

unsuit-

unsuitable to its Nature, retains the suitable Particles for its Augment, and the unsuitable lets pass through it. And in another Place he says they are exhal'd into the Atmosphere.

And this will appear to be the true Case of Plants; and directly contradicts what he advances, in saying, ' That each Sort of Grain takes forth that peculiar Matter that is proper for its own Nourishment. First, the Wheat draws off those Particles that suit the Body of that Plant, *the rest lying all quiet and undisturb'd the while.* And when the Earth has yielded up all them, those that are proper for Barley, a different Grain, remain still behind, till the successive Crops of that Corn fetch them forth too; and so the Oats and Pease in their turn, and, in fine, all is carried off.'

In the former Paragraph he says, each Plant *lets pass through it* the rest of the Particles that are not suitable to its own Nature. In the latter Paragraph he says, That each *leaves* the unsuitable *all behind* for another Sort; and so on.

Both cannot be true.

If the latter were true, Change of Sorts would be as necessary as it is commonly thought. But if the former be true, as I hope to prove it is, then there can be no Use of changing of Sorts in Respect of different Nourishment.

If in this Series of Crops each Sort were so just as to take only such Particles, as are peculiarly proper to it, letting all the rest alone to the other Sorts to which they belonged, as the Doctor imagines; then it would be equal to them all, which of the Sorts were sown first or last: But let the Wheat be sown after the Barley, Pease, and Oats, instead of being sown before them, and then it would evidently appear, by that starv'd Crop of Wheat, either that some or all of those other Grains had violated this natural Probity, or else that Nature has

has given to *Vegetables* no such Law of *Meum* and *Tuum* (g).

If these Things were, as the Doctor affirms, why do Farmers lose a Year's Rent, and be at the Charge of fallowing and manuring their Land, after so few Crops; since there are many more Sorts of Grain as different from these and one another, as those are which they usually sow?

They still find, that the first Crops are best; and the longer they continue sowing, the worst the last Crops will prove, be they of never so different a Species; unless the Land were not in so good Tilth for the first Crop as for the subsequent; or unless the last sown be of a more robust Species.

This Matter might be easily clear'd, could we perfectly know the Nature of those supposed *unsuitable* (b) *Particles*; but, in Truth, there is no more to be

(g) A Charlock could not rob a Turnep, and starve it, more than several Turneps can do, unless the Charlock did take from it the same Particles which would nourish a Turnep: and unless the Charlock did devour a greater Quantity of that Nourishment than several Turneps could take.

Flax, Oats, and Poppy, could not burn or waste the Soil, and make it less able to produce succeeding Crops of different Species, unless they did exhaust the same Particles which would have nourish'd Plants of different Species: For let the Quantity of Particles these Burners take be never so great, the following Crops would not miss them, or suffer any Damage by the Want or Loss of them, were they not the same Particles which would have nourished those Crops, if the Burners had left them *behind, quiet and undisturbed*. Neither could Weeds be of any Prejudice to Corn, if they did draw off those Particles only that suit the Bodies of Weeds, *the rest lying all quiet and undisturbed the while*. But constant Experience shews, that all Sorts of Weeds, more or less, diminish the Crop of Corn.

(b) But we must not conclude, that these Particles, which pass through a Plant (being a vastly greater Quantity than those that abide in it for its Augment), are all unsuitable, because no one of them happens to hit upon a fit *Nidus*: For since the Life of Animals depends upon that of Plants, 'tis not unreasonable to imagine, that Nature may have provided a considerable Over-

plus

be known of such of them, than that they are carried away by the Atmosphere to a Distance, according to the Velocity of the Air; perhaps several Miles off, at least, never like to return to the Spot of Ground from whence the Plants have raised them.

But suppose these cast-off Particles were, when taken in, unfit for the Nourishment of any manner of Vegetables: Then the Doctor must fancy the Wheat to be of a very scrupulous Conscience, to feed on these Particles, which were neither fit for its own Nourishment, nor of any other Plant; and at the same time to forbear to take the Food of Barley, Pease, and Oats, letting that *lie still and undisturb'd the while*, as he says it does, tho' he gives no manner of Reason for it.

'Tis needless to bring stronger Arguments, than the Doctor's Experiments afford, against his own vulgar Opinion, of Plants distinguishing the particular Sort of terrestrial Matter, that, he says, is proper to each Sort of *Vegetable*, in these Words; *viz.* ' Each Sort
' takes forth that peculiar Matter that is proper for its
' own Nourishment, *the rest lying all quiet and undisturb'd*
' *the while.*

He says, that great Part of the terrestrial Matter, mixed with the Water, passes up into the Plant along with it; which it could not do, if only the peculiar Matter, proper to each Plant, did pass up into it: And after he has shewed how apt the vegetable Matter is to attend Water in all its Motions, and to follow it into each of its Recesses; being by no Filtrations or Percolations wholly separable from it; 'tis strange he should think that each Plant leaves the greatest Part of it behind, separated from the Water which the Plant imbibes.

plus for maintaining the Life of individual Plants, when she has provided such an innumerable Overplus for continuing every Species of Animals.

There

There are, doubtless, more than a Million of Sorts of Plants, all of which would have taken up the Water, and had each as much Right to its Share, or proper Matter in it, as the Doctor's Plants had; and then there would be but a very small (or a Millionth) Part of it proper to each of his Plants: And these leaving all the rest behind, both of the Water wherewith the Glasses at first were filled, when the Plants were put into them; and also of all the additional Water daily supply'd into them afterwards; I say, so much more terrestrial Matter brought into these Glasses, in Proportion to the added Water, and so very small a Part as could be proper to each of his Plants being carried off; there must have remain'd in these Glasses a much greater Quantity of terrestrial Matter at the End of the Experiment, than remained in the Glasses *F* or *G*, which had no Plants in them, nor any Water added to, or diminished from them; but the quite contrary appear'd. 'And the Water in
' the Glasses *F* and *G*, at the End of the Experiment,
' exhibited a larger Quantity of terrestrial Matter,
' than any of those that had Plants in them did. The
' Sediment at the Bottom of the Glasses was greater,
' and the *Nubecule* diffus'd thro' the Body of the
' Water thicker.' Had the *Cataputia* infus'd, with the Two thousand Five hundred and One Grains of Water, no more than its proper Share of the vegetable Matter, it could not have attained thence an Increase of Three Grains and a Quarter, nor even the Thousandth Part of One Grain. But he found 'this
' terrestrial Matter, contained in all Water, to be of
' Two Kinds: The one properly, a vegetable Matter,
' but consisting of very different Particles; some of
' which are proper for the Nourishment of some
' kind of Plants, others for different Sorts,' &c.

This, indeed, would have been a most wonderful Discovery, and might have given us a great Light, if he had told us in what Language and Character these

these proper Differences were stamp'd or written upon the vegetable Particles; which Particles themselves, he says, were scarce visible. Certainly it must be a great Art (much beyond that of Dr. Wallis) to decypher the Language of Plants, from invisible Characters.

But that this Dream may deceive none, except such who are very fond of old Errors, there is an *Experimentum Crucis* which may convince them; viz. At the proper Season, tap a Birch-tree in the Body or Boughs, and you may have thence a large Quantity of clear Liquor, very little altered from Water; and you may see, that every other Species of Plants, that will grow in Water, will receive this; live and grow in it, as well as in common Water. You may make a like Experiment by tapping other Trees, or by Water distilled from Vegetables; and you will find no Species of Plants, into which this Water will not enter, and pass through it, and nourish it too; unless it be such a Species as requires more Heat than Water admits; or unless the peculiar Vessels of that it has first passed through, have so altered the vegetable Particles contained in that Water, as that it acts as Poison upon some other particular Species.

The Doctor concludes, ' That Water is only the
 ' Agent that conveys the vegetable Matter to the
 ' Bodies of Plants, that introduces and distributes
 ' it to their several Parts for their Nourishment:
 ' That Matter is sluggish and inactive, and would
 ' lie eternally confin'd to its Beds of Earth, without
 ' ever advancing up into Plants, did not Water, or
 ' some like Instrument, fetch it forth, and carry it
 ' unto them.'

That Water is very capable of the Office of a Carrier to Plants, I think the Doctor has made most evident; but as to the Office of such an Agent as his Hypothesis bestows upon it, it seems impossible to be executed by Water. For it cannot be imagined, that

that Water, being itself but mere homogenous Matter, void of all Degrees of Life, should distinguish each Particle of vegetable Matter, proper and peculiar to every different Species of Plants, which are innumerable; and when 'tis to act for the Wheat, to find out all the Particles proper to that sort of Grain, to rouse only those particular Sluggards from their Beds of Earth, letting all the rest lie quiet and undisturbed the while. This Agent frees the Wheat-Particles from their Confinement, and conveys, introduces, and distributes them, and only them, into the several Parts of the Wheat.

Since 'tis unreasonable to believe, that Water can have such extraordinary Skill in Botany, or in Micrography, as to be qualified for a sufficient Agent in such an abstruse Matter, I conceive Water to be only an Instrument or Vehicle, which takes up indifferently any Particles it meets with (and is able to carry), and advances them (or the *Pabulum* they yield) up into the First Plant, whose Root it comes in Contact with; and that every Plant it meets with does accept thereof, without distinguishing any different Sorts or Properties in them, until they be so far introduc'd and advanc'd up into the vegetable Vessels, that it would be in vain to distinguish them; for whether the terrestrial Matter, Plants imbibe with the Water, will kill or nourish them, appears by its Effects; but which cannot be foreknown or prevented without the Help of Faculties, which Plants are not endow'd with.

Mr. *Bradley* seems to have carried this Error farther than any Author ever did before; but he supports it by Affirmations only, or by such Arguments (I cannot say Reasons; for no Reason can be against any Truth) as go near to confute the very Opinion he pretends to advance by them.

He ascribes to Vegetables the Sense of Taste, by which he thinks they take such Nourishment as is
most

most agreeable to their respective Natures, refusing the rest; and will rather starve, than eat what is disagreeable to their Palate.

In the Preface to his *Vol. I. Page 10.* of his *Husbandry and Gardening*, he says, ‘ They feed as differently as Horses do from Dogs, or Dogs from Fish.’

But what does he mean by this Instance, *Vol. I. p. 39. viz.* ‘ That Thyme, and other Aromatics, being planted near an Apricot-tree, would destroy that Tree?’ Does it not help to confirm, that every Plant does not draw exactly the same Share of Nourishment?

I believe there is no need for him to give more Instances to disprove his Assertion than this one. His Conclusion, taken by itself, is so far right; *viz.* ‘ That if the Nourishment the Earth afforded to the Thyme and Apricot-tree, had been divided into Two Shares, both could not have had them.’

But this his Instance proves, That those Aromatics robb’d the Apricot-tree of so much of its Share as to starve it; and that they, tho’ of so very different a Nature, did draw from the Earth the same Nourishment which the Apricot-tree should have taken for its Support, had not the Aromatics been too hard for it, in drawing it off for their own Maintenance:

Unless he believes, that all the Juices of the Aromatics were as Poison to the Apricot; and that, according to my Experiment of the Mint, some of their Roots might discharge some kind of Moisture in dry Weather, given them by others, that had it for their Use; and that the Apricot-roots, mingling with them, might imbibe enough of that Liquor, altered sufficiently by their Vessels, to poison and kill the Tree.

But then, where was the Tree’s distinguishing Palate? Why did it not refuse this Juice, which was so disagreeable as to kill it? And as to his Notion of

Vegetables having Palates, let us see how it agrees with what he affirms.

‘ That ’tis the Vessels of Plants that make, by their Filtrations, Percolations, &c. all the different Tastes and Flavours of the Matter, which is the Aliment of Plants; and that, before it be by them so filtered, &c. it is only a Fund of insipid Substance, capable of being altered by such Vessels, into any Form, Colour, or Flavour.’

And *Vol. I. p. 38.* ‘ The different Strainers, or Vessels of the several Plants, growing upon that Spot of Earth, thus impregnated with Salts, alter those Salts or Juices, according to the several Figures or Dimensions of their Strainers; so that one Plant varies, in Taste and Smell, from others, tho’ all draw their Nourishment from the same Stock lodged in the Earth.’ See Mr. *Bradley’s Palates of Plants*, and the insipid Substance he allots them to distinguish the Taste of, how they agree.

They must, it seems, within their own Bodies, give the Flavour to this insipid Substance, before their Palates can be of any Use; and, even then, ’tis impossible to be of any Use, but in the manner of the the Dog returning to his Vomit.

They would have as much Occasion for the Sense of Smelling, as of Taste; but, after all, of what Use could either of the Two be to Plants, without local Motion of their Roots? which they are so destitute of, that no Mouth of a Root can ever remove itself from the very Point where it was first formed, because a Root has all its longitudinal Increase at the very End; for, should the Spaces betwixt the Branchings increase in Length, those Branches would be broken off, and left behind, or else drawn out of their Cavities; which must destroy the Plant. All the Branches, except the foremost, would be found with their Extremities pointing towards the Stem; the contrary of which

which Posture they are seen to have: And if they moved backwards, that would have much the same Effect on all the collateral Branchings to destroy them. Smell and Taste then could be of no manner of Use to Vegetables, if they had them; they would have no Remedy or Possibility to mend themselves from the same Mouths, removing to search out other Food, in case they had Power to dislike or refuse what was offered them.

Therefore the crude Earth, being their Food, simple and free from any Alterations by Vessels, remaining insipid, cannot give, neither can Plants receive, require, or make use of, any Variety from it, as Animals do from their Diet. It would be lost upon them, and Nature would have acted in vain, to give Smell and Taste to Vegetables, and nothing but insipid Earth for an Object of them; or to give them a charming Variety of Relish and Savour in their Food, without giving them Senses necessary to perceive or enjoy them; which would be like Light and Colours to the Blind, Sound and Music to the Deaf, or like giving Eyes and Ears to Animals, without Light or Sound to affect them.

The Mouths of Plants, situate in the convex Superficies of Roots, are analogous to the Lacteals, or Mouths, in the concave Superficies of the Intestines of Animals.

These spongy Superficies of animal Guts, and vegetable Roots, have no more Taste or Power of refusing whatever comes in Contact with them, the one than the other.

The free open Air would be equally injurious to both; and if exposed to it, it would dry and close up the fine Orifices in Guts and Roots: Therefore Nature has guarded both from it.

Nature has also provided for the Preservation of both Vegetables and Animals (I do not say equally)

Q

in

in respect of their Food; which might poison them, or might not be fit to nourish them.

The Security of Plants (the best that can be) is their Food itself, Earth; which, having been altered by no Vessels, is always safe and nourishing to them; For a Plant is never known to be poisoned by its own natural Soil, nor starved, if it were enough of it, with the requisite Quantities of Heat and Moisture.

Roots, being therefore the Guts of Plants, have no need to be guarded by Senses; and all the Parts and Passages, which serve to distinguish and prepare the Food of Animals, before it reach the Guts, are omitted in Plants, and not at all necessary to them.

But as the Food of most Animals is Earth, very variously changed and modified by vegetable or animal Vessels, or by both, and some of it is made wholesome, some poisonous; so that if this doubtful Food should be committed to the Intestines, without Examination, as the pure unaltered Earth is to Roots, there would, in all Probability, be very few Animals living in the World, except there be any that feed on Earth at first Hand only, as Plants do.

Therefore, lest this Food, so much more refined than that of Plants, should, by that very means, become a fatal Curse, instead of a Blessing to Animals, Nature has endowed them with Smell and Taste, as Sentinels, without whose Scrutiny these various uncertain Ingredients are not admitted to come where they can enter the Lacteals, and to distinguish, at a sufficient Distance, what is wholesome and friendly, from what is hurtful; for when 'tis once passed out of the Stomach into the Guts, 'tis too late to have Benefit from Emetics; its Venom must then be imbibed by the Lacteal Mouths, and mix with the Blood, as that must mix with the Sap, which comes in Contact with the Lacteals in the Superficies of Roots, Nature having left this unguarded.

Yet

Yet Plants seem to be better secured by the Salubrity and Simplicity of their Food, than Animals are by their Senses: To compensate that Inequality of Danger; Animals have Pleasure from their Senses, except some miserable Animals (and such there are) that have more Pain than Pleasure from them. But I suppose, more Animals than Plants are poison'd; and that a poisonous Animal is less fatal to a Plant, than a poisonous Plant is to an Animal.

It being sufficiently proved, that every sort of Vegetables, growing in the same Soil, takes, and is nourished, by the same Sort of Food; it follows from hence, that the beneficial Change of Sorts of Seeds or Plants, we see in the common Husbandry, is not from the Quality of the Sorts of Food, but from other Causes; such as,

- I. *Quantity of the Food.*
- II. *Constitution of the Plants.*
- III. *Quantity of the Tillage.*

In Dr. *Woodward's* Case, upon his Hypothesis, the Three Proportions of Seeds, *viz.* Barley, Oats, and Pease, might be sown all together in the same Acre of Ground, the same Year, and make Three as good Crops as if sown singly in Three successive Years, and his Two Crops of Wheat in one Year likewise. But every Farmer can tell, that these Three Proportions of Seed would not yield half the Crop together, as one would do single; and would scarce produce more than to shew what Grains were sown, and which of the Sorts were the strongest, and the most able Robber.

Though this Failure would, in Truth, be from no other Cause than want of the sufficient Quantity of Food, which those Three Crops required; yet, perhaps, the Doctor might think, that all Three Crops might succeed together very well, taking each its proper Nourishment, were it not for want of Room, Air, and Sun.

I have been credibly inform'd, that on One Perch of Ground there has grown a Bushel of Corn, which is Twenty Quarters to an Acre. Mr. *Houghton* relates Twenty-six, and even Thirty Quarters, of Wheat on One Acre. There have certainly grown Twelve Quarters of Barley to an Acre, throughout a whole Field: Therefore, unless a Crop exceed the least of these, or indeed the greatest of them (if the Relation be true), a Crop cannot fail for want of Room; for one Acre (be it of what Nature it will, as to the Soil of it) must have as much room for a Crop to grow on, as any other Acre.

Then there was room for all Dr. *Woodward's* Three Crops together, to produce as much as Three common Crops do. Yet all these together will scarce yield one Quarter of Corn, tho' there is room, at least, for Twelve.

The same *Air* and *Sun* that had Room to do their Office to Mr. *Houghton's* Acre, why should they not have Room to do the same to Doctor *Woodward's* Acre, when the Three Crops growing on it at once, through pretty good ones, might require less Room than Mr. *Houghton's* Crop did?

I perceive that those Authors, who explain *Vegetation*, by saying the Earth imbibes certain Qualities from the Air, and by specific Qualities, and the like, do also lay a great Stress upon the *perpendicular* Growth of *Vegetables*; seeming to fancy there is little else necessary to a good Crop, but Room.

Mr. *Bradley*, in his Arguments concerning the Value of an Hill, does implicitly say as much.

But if they would but consider the Diameters of the Stems, with the Measure of the Surface of an Acre, they would be convinced, that many, even of Mr. *Houghton's* Crops, might stand in a perpendicular Posture upon an Acre, and Room be left.

One true Cause of a Crop's failing, is want of a Quantity of Food to maintain the Quantity of *Vegetables*, which the Food should nourish.

When the Quantity of Food which is sufficient for another Species (that requires less), but not for that which last grew, to grow again the next Year, then that other is beneficial to be planted after it.

The Second true Cause is from the Constitution of Plants; some require more Food than others, and some are of a stronger Make, and better able to penetrate the Earth, and forage for themselves.

Therefore Oats may succeed a Crop of Wheat on strong Land, with once plowing, when Barley will not; because Barley is not so well able to penetrate as Oats, or Beans, or Pease, are.

So a Pear-tree may succeed a Plum-tree, when another Plum-tree cannot; because a Pear is a much stronger Tree, and grows to a much greater Bulk; so inclined to be a Giant, that 'tis hard to make it a Dwarf; and will penetrate and force its Way thro' the untill'd Earth, where the other cannot; being of a weaker and less robust Constitution, not so well able to shift for itself.

The Pear could penetrate Pores, that the other could not. Mr. *Evelyn* says, in his Discourse of Forest-trees, 'That a Pear will strike Root thro' the roughest and most impenetrable Rocks and Cliffs of Stone itself.' He says likewise, in his *Pomona*, 'That Pears will thrive where neither Apple or other Fruit could in Appearance be expected.'

I can scarce think, that a large Plant takes in larger Particles than a small one, for its Nourishment: If it did, I can't believe, that the Thyme could have starv'd the Apricot-tree; it must have left the larger Particles of Food for that Tree, which probably would have sufficed to keep it alive: I rather think, that great and small Plants are sustain'd by the same minute Particles; for, as the fine Particles of Oats will nourish an Ox, so they will nourish a Tom-tit, or a Mite.

Some Plants are of an hotter Constitution, and have a quicker Digestion, like Cormorants or Pigeons, devouring more greedily, and a greater Quantity of Food, than those of a colder Temperature, of equal Bulk, whose Sap, having a more languid Motion, in proportion to the less Degree of Heat in it, sends off fewer Recrements; and therefore a less Supply of Food is required in their room. This may make some Difference in the one's succeeding the other; because the hot-constitution'd leaves not enough for its own Species to succeed again, but leaves enough for a Species of a colder Constitution to succeed it.

But the Third and chiefest Cause of the Benefit of changing Sorts is Quantity of Tillage, in proportion to which the Food will be produced.

The true Cause why Wheat is not (especially on any strong Soil) to be sown immediately after Wheat, is, That the first Wheat standing almost a Year on the Ground, by which it must grow harder; and Wheat Seed-time being soon after Harvest in *England*, there is not Space of Time to till the Land so much as a second Crop of Wheat requires.

Tho' sometimes in poorer Land, that is lighter, Wheat has succeeded Wheat with tolerable Success; when I have seen, on very rich strong Land, the first Crop lost by being much too big, and one following it immediately, quite lost by the Poorness of it, and not worth cutting.

This was enough to satisfy, that the Tillage which was so much easier perform'd in less Time, sufficed for the light Land, but not for the strong: and, if the strong Land could have been brought into as good Tith as the light (like as in the new Husbandry it may), it would have produced a much better second Crop than the light Land did.

From all that has been said, these may be laid down as Maxims; *viz.* That the same Quantity of Tillage

Tillage will produce the same Quantity of Food in the same Land (*a*); and that the same Quantity of Food will maintain the same Quantity of Vegetables.

'Tis seen, that the same Sort of Weeds, which once come naturally in a Soil, if suffer'd to grow, will always prosper in proportion to the Tillage and Manure bestow'd upon it, without any Change. And so are all manner of Plants, that have been yet try'd by the new Husbandry, seen to do.

A Vineyard, if not tilled, will soon decay, even in rich Ground, as may be seen in those in *France*, lying intermingled as our Lands do in common Fields. Those Lands of Vines, which by reason of some Law-suit depending about the Property of them, or otherwise, lie a Year or two untilled, produce no Grapes, send out no Shoots hardly: the Leaves look yellow, and seem dead, in Comparison of those on each Side of them; which, being tilled, are full of Fruit, send out an hundred times more Wood, and their Leaves are large and flourishing; and continue to do the same annually for Ages, if the Plough or Hoe do not neglect them.

No Change of Sorts is needful in them, if the same annual Quantity of Tillage (which appears to provide the same annual Quantity of Food) be continued to the Vines.

But what in the Vineyards proves this Thesis most fully is, That where they constantly till the low Vines

(*a*) And *cæteris paribus*; for when the Land has been more exhausted, more Tillage (or Dung) or Rest will be required to produce the same Quantity of Food, than when the Land hath been less exhausted. By Tillage is here meant, not only the Number of Plowings, but the Degree of Division or Pulveration of the Soil; or, if perchance the Soil is extraordinary much exhausted by many Crops, without proper Tillage between them, the greater Degree of Pulveration, by Plowing or Dung (which is only a *Succedaneum* of Tillage), and also a longer Time of Exposure, may be necessary to counterpoise that extraordinary Exhaustion.

with the Plough, which is almost the same with the Hoe-plough, the Stems are planted about Four Feet asunder, chequerwise; so that they plow them Four ways. When any of these Plants happen to die, new ones are immediately planted in their room, and exactly in the Points or Angles where the other have rotted; else, if planted out of those Angles, they would stand in the Way of the Plough: These young Vines, I say, so planted in the very Graves, as it were, of their Predecessors, grow, thrive, and prosper well, the Soil being thus constantly tilled: And if a Plum-tree, or any other Plant, had such Tillage, it might as well succeed one of its own Species, as those Vines do.

'Tis observed, that White-thorns will not prosper, set in the Gaps of a White thorn Hedge: But I have seen the Banks of such Gaps dug and thrown down one Summer, and made up again, and White-thorns there replanted the following Winter, with good Success.

But note, That the annual plowing the Vines is more beneficial than the one Summer Tillage of the Banks, the Vines having it repeated to them yearly.

I have, by Experience and Observation, found it to be a Rule, That long Tap-rooted Plants, as Clover and St. Foin, will not succeed immediately after those of their own or any other Species of long Tap-roots, so well as after horizontal-rooted Plants; but, on the contrary, horizontal will succeed those Tap-roots as well or better than they will succeed horizontal.

I confess, this Observation did, for a great while, cheat me into the common Belief, That different Species of Plants feed on different Food; till I was delivered from that Error, by taking Notice, that those Tap-roots would thrive exceedingly well after Turneps, which have also pretty long Tap-roots, though Turneps never thrive well immediately after
Clover,

Clover (*a*), or St. Foin: I found the true Cause of this Exception to that Rule to be chiefly the different Tillage (*b*).

Land must be well tilled for Turneps, which also are commonly hoed; they stand scarce ever above Three-quarters of a Year, and are then fed on the Ground; and then the succeeding Crop of Corn has, by that means, the Benefit of twice as much Tillage from the Hoe, as otherwise would be given to it; and the Broad Clover, or St. Foin, sown with the Corn (if the Corn be not so big as to kill it), will enjoy, in its Turn, a Proportion of the extraordinary Tillage, and of the Dung of Cattle, which feed the Turneps, and thrive accordingly: But Broad Clover and St. Foin, being perennial Plants, stand on the Ground so long, that it lies several Years untilled; so that Turneps, sown immediately after these, do fail, for want of their due Tillage, for which there is not sufficient time, by plowing often enough; because, by the common Ploughs, it requires Two or Three Years to make it fine enough for Turneps, or for a Repetition of Clover, or St. Foin, in strong or swardy Land.

Another Reason why any Crop succeeds well after Turneps (and besides their being spent on the Ground where they grow) is their cold Constitution, by which they are maintained with less Food than another Plant of the same Bulk.

The *Parenchyma*, or fleshy Part of a Turnep, consisting of a watry Substance, which cools the Vessels, whereby the Sap's Motion is very slow, in proportion to the very low Degree of Heat it has, and

(*a*) But when Clover has been fed by Cattle, the Ground being good, and well tilled, Turneps may thrive immediately after Clover: Therefore this is an Exception to the general Rule.

(*b*) Very mellow rich Land is so full of vegetable Food, that 'tis an Exception to most Rules; and therefore I speak not of that.

sends off its Recrements in the same Proportion likewise; and therefore requires the less of the terrene Nourishment to supply those Recrements.

This is seen, when a Bushel of Turneps, mixed with a Quantity of Wheaten Flour, is made into Bread, and well baked: This Bushel of Turneps gives but few Ounces Increase in Weight, more than the same Quantity of Wheaten Flour made into Bread, and baked without any Turneps. This shews there is in a Turnep very little Earth (which is the most permanent Substance of a Plant); the Oven discharges in Vapour near all but the largest Vessels: Its earthly Substance being so small, is a Proof 'tis maintained by a small Quantity of Earth: and, upon that Account also, of less Damage to the next Crop than another Plant would be, which required more of the solid Nourishment to constitute its firmer Body, as a Charlock does; for when a Charlock comes up, contiguous to, and at the same time with a Turnep, it does so rob the Turnep, that it attains not to be of the Weight of Five Ounces; when a single Turnep, having no more Scope of Ground, and, in all respects (but the Vicinity of the Charlock), equal, weighs Five Pounds, yet that Charlock does not weigh One Pound.

And where Three Turneps coming up, and growing thus contiguous, will weigh Four Pounds; a Charlock joined with Two or Three Turneps, all together, will be less than one Pound, upon no less Space of Ground.

This Observation cannot be made, except where Turneps are drilled in Rows; and there 'tis easy to demonstrate, that a Charlock, during the time of its short Life, draws much more Earth than a Turnep of equal Bulk, from an equal Quantity of Ground (c).

The

(c) 'Tis certain that Turneps, when they stand for Seed, suck and impoverish the Ground exceedingly: For though they are of

The true Cause why Clover and St. Foin do not succeed so well after their own respective Species, or that of each other, as Corn, &c. can, is, that they take great Part of their Nourishment from below the Plough's Reach, so as that under Earth cannot be tilled deep enough, but the upper Part may be tilled deep enough for the horizontal Roots of Corn, &c. towards which, the Rotting of the Clover and St. Foin Roots, when cut off by the Plough, do not a little contribute (*d*); And there's no doubt but that, if the

a cold Constitution, and consequently consume less Food than Plants of an hotter Constitution, and of the same Bulk; yet these Seed-turneps being of so vast a Bulk, as sometimes Eighty Quarters of their Roots grow on an Acre, and their Stalks have been measured Seven Feet high, and their Roots having continued at near their full Bigness for about Ten Months together, and then carried off, they drain the Land more than a Crop of other Vegetables of a less Bulk, and an hotter Constitution, and which live a less time; or than Wheat, which, though it lives as long, is very small, except in the Four last Months.

(*d*) That the Rotting of vegetable Roots in the Ground doth ferment therein, and improve it for horizontal-rooted Plants. I am convinced by an Accident; *viz.* My Man had plowed off the Earth close to the Rows in a Field of extraordinary large Turneps designed for Seed. This Earth was neglected to be thrown back to the Rows, until a severe Frost in the Winter came, and killed the Turneps; upon which, in the Spring, the Field was sown with Barley upon the Level, with only *once* plowing, and that cross-ways of the Rows. The Turneps had stood so wide asunder, that the Spot whereon each had rotted, appeared like the Spot whereon an Horse had urined in till'd Ground, and was of a deeper Colour, and much higher, than the Barley that grew round those Spots; and yet none of it was poor. As the Roots of Clover, and St. Foin, are very much less; yet the greater Number rotting in plowed Ground must be of great Use to a following Crop of Corn.

I will here relate Two Examples of this in St. Foin: The one is, That a Field of Twenty-five Acres drilled with St. Foin, except Three Acres in the Middle of it, which was, at the same time, sown with Hop-Clover; after Eight Years the whole Field was plowed up by a Tenant, and sown with Corn: The St. Foin had been mowed yearly, as the Hop-Clover was not mowed at
all,

the under Earth could be as well tilled for the Tap-roots, as the upper Earth is for the horizontal, the Tap-roots would succeed one another as well as the horizontal would succeed them, or those of their own Species, or as the Tap-roots do the horizontal.

all, but fed by Horfes teddered (or staked) thereon the First and Second Years; and after that had nothing on it but poor natural Grass.

The whole Field was managed alike, when plowed up; but the Three Acres produced visibly worse Crops of Corn than the rest all round it, which had produced St. Foin.

The other Example or Instance was, Where an Acre, Part of a Field, was, by a Fancy, drilled with St. Foin in single Rows, about Thirty-three Inches asunder, but was never hoed: After Seven Years it was plowed up with the rest of the Field cross the Rows, and sown with Oats upon the Back Three Months after plowing. These Rows were as visible in the Oats, as if the St. Foin had been still remaining there: The Oats in the Rows where the St. Foin had been, looked of a deep green flourishing Colour, at first coming up, and until they were about half a Foot high, and the Spaces between them looked yellowish; but afterwards the Difference of their Colour disappeared, all the Crop being very good. Upon this I imputed it to the Rotting of the Roots, which by their Singleness were very large; and when the different Colours disappeared, I suppose the Roots of all the Oats had reached to the Benefit of the rotted Roots, which might also be then spread farther into the Spaces; and I doubt not but that the Rotting of Broad Clover-roots has the same Effect as of St. Foin, for manuring of Land, especially when the Roots are large.

Some have objected against this Opinion, and say the Effect was rather to be imputed to the Rows of St. Foin shadowing the Earth under them, or else from their keeping the Earth under them free from Couch-grass, of which the Intervals were full: But I think it more probable, that the Couch-grass, having very long horizontal Roots, might draw Nourishment from the Earth under the Rows, and from the Intervals equally.

And as to the Shadow of the Rows, tho', for the First and Second Years, the St. Foin Plants were very large; yet, being afterwards, for Five or Six Years, until plowed up, constantly fed by Cattle, and being more sweet, was eaten very low, whilst the Couch-grass remained intire in the Intervals, and shadowed them more than the Earth of the Rows was shadowed by the St. Foin: Besides, the rotten Turneps, which were freed from both these Objections, had the same Effect on the Barley, as the St. Foin had on the Oats.

The

The under Earth, in some time, is replenished by what the Rains leave, when they sink through it; and then Tap-rooted Plants may be there nourished again, tho' the upper Earth be drained by the Corn; so that no Change is so beneficial, as that betwixt Tap-rooted Plants, and those which have only horizontal ones. The former are provided for by Rains, though not so speedily as the latter are by Tillage and Hoeing.

Pastures require no Change of Herbs; because they have annually the same Supply of Food from the Dunging of Cattle that feed on them, and from the Benefit of the Atmosphere.

Meadows hold out without Change of Species of Grass, tho' a Crop be carried off every Year; the Richness of that Soil, with the Help of the Atmosphere, Dung of Cattle in feeding the After-Crop, or else Flooding, from the overflowing of some River, some, or all of which, supply the Place of the Plough to a Meadow.

Woods also hold out beyond Memory or Tradition, without changing Sorts of Trees; and this by the Leaves, and perhaps old Wood, rotting on the Soil annually, which operate as a Manure; because, as has been said, Earth which has once passed any Vessels, is so changed, that, for a long time after, it does not retain its Homogeneity (*e*) so much as to mix with pure Earth, without fermenting; and by the Descent of the Atmosphere, the Trees shadowing the Soil, to prevent the Re-ascend of what that brings down; all this, resembling Tillage, continually divides the Soil, and renews the Food equal to the Consumption of it made by the Wood.

And the last Argument I shall attempt to bring for Confirmation of all I have advanced, is that

(*e*) Not that the Particles of Earth are strictly homogeneous, but that they are much less heterogeneous, before they are altered by Vessels, than afterwards.

which proves both the Truth and Use of the rest; viz. That when any Sort of Vegetable, by the due Degrees of Heat and Moisture it requires, is agreeable to a Soil, it may, by the new Horse-hoeing Husbandry, be continued without ever changing the Species.

C H A P. XV.

Of Change of INDIVIDUALS.

SEEDS, in their natural Climate, do not degenerate, unless Culture has improved them; and then, upon Omission of that Culture, they return to their first natural State.

As the Benefit of changing of Species of Seeds is from Difference of Tillage, so the Benefit of changing Individuals of the same Species appears to be from those Causes which are, generally, themselves, the Effects of different Climates, such as Heat and Moisture, which may also vary very much in the same Latitude and Neighbourhood; as the same Mountain in the Country of the *Mogul* (related by Mr. *Evelyn*, from Monsieur *Bernier*), on the South Side produces *Indian* Plants, and on the North Side *European* Plants, from different Exposures; and some Land, retaining Water longer, is colder; some, suffering it to pass down quicker, and by the Nature and Figure of its Parts, causes such a Refraction and Reflexion of the Sun's Rays, which give a great Warmth, as in Sand, and gravelly Grounds, that are well situate, and have an under Stratum of some Sort of hollow Matter, next under the Staple (a),

(a) This hollow Matter lets the Water pass down the sooner from the Surface, whereby the Staple of the Ground becomes the drier, and consequently warmer.

or upper Stratum, wherein the Plough is exercised.

This beneficial Change of Individuals seems rather to be from the forementioned Causes, than from Change of Food ; and these Causes shew their Efficacy, chiefly in the Generation or Foetation of those Seeds ; as Flax-seed brought from *Holland*, and sown here, will bring as fine Flax as there ; but the very next Generation of it coarser, and so degenerating gradually, after Two or Three Descents, becomes no better than the common ordinary Sort ; yet its Food is the same, when the Flax is fine, as when 'tis coarse.

And so it is, when Individuals of Wheat are changed: So Silk-worms, hatched and bred in *France*, of Eggs or Seed brought from *Italy*, will make as fine Silk as the *Italian* ; but the Eggs of these laid in *France* and their Issue, will make no better Silk than the *French* ; though their Food be from Leaves of the same Mulberry-trees, when they make fine Silk and coarse : Therefore 'tis from the Climate, where the Eggs are impregnated, not where they have their Incubation or Food, when hatched, and fed to their Lives End, that this Difference happens.

Common Barley, sown once in the burning Sand at *Patney* in *Wiltshire*, will, for many Years after, if sown on indifferent warm Ground, be ripe Two or Three Weeks sooner than any other (*b*), which has
never

(*b*) Barley is far from being improved by becoming rath-ripe ; for it loses more good Qualities than it gets by being sown at *Patney* : 'Tis so tender, that if it be sown early, the Frost is apt to kill it ; or if it be sown late in *May*, on the same Day, and in the same Soil, with the same Sort of Barley that is not rath-ripe, it will be much thinner bodied than the late ripe ; and besides, if it happens to have any Check by Cold or Drought, it never recovers it as the other doth, at what time soever it is sown. It is now, I am informed, gone out of Fashion, and very few Farmers have sown it of late Years. I know a Noble Parish, that.

never been impregnate at *Patney*: But if sown a Degree farther North, on cold clayey Land, will, in Two or Three Years, lose this Quality, and become as late ripe as any other.

Indeed *Patney* is far from improving the Species of Barley, except we think it improved by becoming more weak and tender, and shorter-lived; which last-mentioned Quality fits it for such Countries, where the Summers are too short for other Barley to ripen.

The Grains or Seeds of Vegetables are their Eggs; and the individual Plants, immediately proceeding from them, have not only the Virtues they received in Embryo (or rather *in plantulis*), but the Diseases also; for when smutty Wheat is sown, unless the Year prove very favourable, the Crop will be smutty; which is an evident Token of *mala stamina*.

The smutty Grains will not grow; for they turn to a black Powder: But when some of these are in a Crop, then, to be sure, many of the rest are infected; and the Disease will shew itself in the next Generation, or Descent of it, if the Year wherein 'tis planted prove a wet one.

Weeds, and their Seed, in the Fields where they grow naturally, for Time immemorial, come to as great Perfection as ever, without Change of Soil.

These Weeds, with Acorns, and other Masts, Crabs, Sloes, Hips, and Haws, are thought to have been, originally, the only natural Product of our Climate: Therefore other Plants being Exotics, many of them, as to their Individuals, require Culture and Change of Soil, without which they are liable more or less to degenerate.

But to say, that the Soil can cause Wheat to degenerate into Rye, or convert Rye into Wheat, is what

I believe, formerly lost about Two hundred Pounds *per Ann.* by sowing rath-ripe Barley: But long and dear Experience hath now convinced them of their Error, and obliged them totally to disuse it.

reflects upon the Credit of *Laurembergius*: 'Tis as easy to believe, that an Horse, by feeding in a certain Pasture, will degenerate into a Bull, and in other Pasture revert to an Horse again; these are scarce of more different Species than Wheat and Rye are: If the different Soil of *Wittemberg* and *Thuringia* change one Species, they may the other.

C H A P. XVI.

Of RIDGES.

THE Method of plowing Land up into Ridges is a particular Sort of Tillage; the chief Use of which is, the Alteration it makes in the Degrees of Heat and Moisture, being two of the grand Requisites of Vegetation; for very different Degrees of these are necessary to different Species of Vegetables.

Those Vegetables commonly sown in our Fields, require a middle Degree of both, not being able to live on the Sides of perpendicular Walls in hot Countries, nor under Water in cold ones, neither are they amphibious, but must have a Surface of Earth not cover'd, nor much soak'd with Water, which deprives them of their necessary Degree of Heat, and causes them to languish. The Symptoms of their Disease are a pale or yellow Colour in their Leaves, and a Cessation of Growth, and Death ensues as sure as from a Dropsy.

The only Remedy to prevent this Disease in Plants is, to lay such wet Land up into Ridges, that the Water may run off into the Furrows, and be convey'd by Ditches or Drains into some River.

The more a Soil is fill'd with Water, the less Heat it will have.

The Two Sorts of Land most liable to be overglutted with Water, are Hills, whereof the *Upper Stratum* (or Staple) is Mould lying upon a *Second Stratum* of Clay;

And generally all strong deep Land.

Hills are made wet and spewy by the Rain-water which falls thereon, and soaks into them as into other Land; but being stopp'd by the Clay lying next the Surface or Staple, cannot enter the Clay; and for want of Entrance, spreads itself upon it; and as Water naturally tends downwards, it is by the incumbent Mould partly stopp'd in its Descent from the upper towards the lower Side of an Hill; and being follow'd and press'd on by more Water from above, is forced to rise up into the Mould lying upon it, which it fills as a Cistern does a Fountain (or *Jet d'Eau*). The Land of such an Hill is not the less wet or spewy for being laid up in Ridges, if they be made from the higher to the lower Part of the Field; for the Force of the Water's Weight continued will raise it so, as to cause it to issue out at the very Tops of those Ridges; the Earth becomes a sort of Pap or Batter, and being like a Quagmire, in going over it, the Feet of Men and Cattle sink in till they come to the Clay.

There are two Methods of draining such a wet Hill: The one is to dig many Trenches, cross the Hill horizontally (*a*), and either fill them up with Stones loose or archwise, through which the Water, when it soaks into the Trenches, may run off at one or both Ends of them into some Ditch, which is lower,

(*a*) For if they are made with the Descent, and not across it, then they will be parallel to the Rills of Water, that run upon the Surface of the Clay under the Staple (or upper *Stratum* of Mould), and would be no more effectual for draining the Hill, than the digging of one River parallel to another, without joining it in any Part, would be effectual for draining the other River of its Water.

and

and carries it away; then they cover the Trenches with Mould, and plow over them as in dry level Ground.

This Method has been found effectual for a time, but not of long Continuance; for the Trenches are apt to be stopp'd up, and then the Springs break out again as before: Besides, this is a very chargeable Work, and in many Places the Expence of it may almost equal the Purchase of the Land.

Therefore 'tis a better Method to plow the Ridges cross the Hill almost horizontally, that their parting Furrows, lying open, may each serve as a Drain to the Ridge next below it; for when the Plough has made the Bottom of these horizontal Furrows a few Inches deeper than the Surface of the Clay, the Water will run to their Ends very securely, without rising into the Mould, provided no Part of the Furrows be lower than their Ends.

These parting Furrows, and their Ridges, must be made more or less oblique, according to the Form and Declivity of the Hill; but the more horizontal they are, the sooner the Rain-water will run off the Lands; for in that Case it will run to the Furrows, and reach them at right Angles, which it will not do when the Ridges (or Lands) are oblique; and therefore the Water's Course cross the Lands will be longer (*a*). Every one of these horizontal Trenches receives

(*a*) The natural Course of Water being downwards, it would always run by the nearest Way to the Bottom of the Hill, if nothing stop't it; but the Water runs from an Hill in Two Manners; *viz.* Upon the Surface of the Staple, and upon the Surface of the Clay that is under the Staple; that which runs under keeps its strait Course from the Top to the Bottom of an Hill, under a Ridge that is made exactly with the Descent of the Hill, except that Part of the Water that rises up into the Mould, and a very little that soaks into the Furrows, for when the Furrows are not made exactly with the Descent, the more oblique they are to the Descent, the longer will be the Water's Course under the Ridges; and the shorter, as they are nearer being at Right Angles to the

receives all the Water from the Rills, or little Gutters, wherein the Water runs betwixt the Mould and the Clay; these are all cut off by the Trenches, which receive the Water at their upper Sides, and carry it away, as the Trunks of Lead plac'd under the Eaves of a House do carry away the Rain-water.

If there were no other Manner of plowing Ridges on the Sides of Hills than what is commonly practised on the Plains, this Method of leaving open Furrows (or Drains on Declivities) would be impracticable; because the Plough could not turn up the Furrows against the Hill, and against the Ridge also, from the lower Side of it: But the easy Remedy against that Inconvenience is, to plow such Ridges in Pairs, without throwing any Earth into the Trenches, and then the Ridges will be plain a-top, and the Rain-water will run speedily downward to the next Trench, and thence to the Head-land, and so out of the Field. These Trenches will be made, as well as kept always open, by this plowing in Pairs; and is abundantly more easy than the Way of plowing Ridges singly. This plowing in Pairs prevents also another Inconveniency, which would otherwise happen to these horizontal Ridges; and that is, they being highest in the Middle, the Rain-water could not run freely from the upper Half of a Ridge towards the next Furrow below it, but would be apt to sink in there, and soak thro' the Ridge; but when Ridges lie in Pairs, the Water will run off from a whole Ridge, as well as off the lower Half of a Ridge that is plow'd singly, and highest in the Middle.

Descent. 'Tis also the same with the Water that falls upon the Surface of the Ridges; for the more horizontal they are, the shorter its Course will be from them to the Furrows, which carry it off; and the less of the Water will sink into the Ridges, the less oblique and the nearer to Right Angles to the Descent they are made.

Note,

Note, That every time of plowing, the Pairs must be changed, so that the Furrow, which had Two Ridges turned towards it one time, must have Two turned from it the next time: This Method keeps the Surfaces of all the Ridges (or Lands) pretty near even (*a*).

Farmers are at more Trouble and Pains to drown such Land (it being common to break their Horses Wind in plowing up Hill) than they would be at, if they laid their Ridges in the abovesaid Manner, which would effectually make them dry. Many hundred Acres of good Ground are spoiled; and many a good Horse, in plowing against the Hill, and against all Reason, Demonstration, and Experience too; which might be learned even from the *Irish*, who drain their Bogs, and make them fruitful, whilst some *English* bestow much Labour to drown and make barren many of their Hills, which would more easily be made dry and fertile.

I have observed, that those Places of such an Hill, that, when plowed with the Descent, were the wettest, and never produced any thing that was sown on them, became the very richest, when made dry by plowing cross the Descent. This shews that Water does not impoverish Land, but the contrary; tho', whilst it stands thereon, it prevents the Heat which is necessary to the Production of most Sorts of Vegetables: And where it runs swiftly, it carries much Earth away with it; where it runs slowly, it deposits and leaves much behind it.

Though in all Places, where this Way of making the Ridges cross the Descent of Hills is practised, the Land becomes dry; yet very few Farmers will

(*a*) *Note*, This cannot be done on an Hill, whose Declivity is so great, that the Plough is not able to turn a Furrow against it. But in this Case, perhaps, it may be sufficient to plow the Ridges obliquely enough for the Furrow to be turned both Ways.

alter their old Method (*a*); no, not even to try the Experiment; but still complain their Ground is so wet and spewy, that it brings them little or no Profit; and if the Year prove moist, they are great Losers by sowing it (*b*).

(*a*) But some of late are convinced, by observing that an Hill of mine has been made dry by this means for Fourteen Years past, which before was always more wet and spewy than any Field in the Neighbourhood; and from the time of inclosing it out of an Heath (or Common), and the converting it to arable, which was about Seventy Years ago, it had been reputed as little better than barren, on account of its Wetness; and that it has been the most profitable Field of my Farm ever since it has been under this new Management. I have also another Field, that lies about a Mile and an half from me: It doth not belong to the Farm where I live, but was thrown upon my Hands, no Tenant caring to rent it, because great Part of it was full of Springs, and barren: This also, having been kept in Lands plowed cross the Descent (which is but a small Declivity), is become dry: And now the most prejudiced Farmers agree, that keeping the Lands or Ridges of wet Ground always cross the Descent doth cure its Spewiness. Hereupon some have attempted to put this Method in Practice on their wet Land; and, after it has been well tilled up Hill and down, have plowed it the last time for sowing of Wheat in flat Lands cross the Descent; but by Mismanagement their Furrows are higher at each End than the Middle, so that none of the Water can run off either downwards or sideways, or any other Way.

Had the Furrows carried off the Water at both or either of their Ends, it might have been effectual, notwithstanding the broad Lands, because their Ground hath a much less Declivity, and is much less spewy, than my Hill was: They will doubtless find their Mistake, and amend it, having a Precedent before their Eyes; but if they had none within their own Inspection, I question whether this Mismanagement might not discourage them from prosecuting their Project any further.

(*b*) Remember, in making Ridges of all Sorts, and of whatsoever Figure the Piece is, that no Ridge ought to have any more Furrows at one End, than at the other End; for if there be, the Plough must be turned in the Middle of the Piece, which will cause the Land to be trodden by the Horses; but if each End have an equal Number of Furrows, the Horses in turning will tread only upon the Head lands, which may be plowed afterwards; or if design'd to be Horse-ho'd, the Head-lands should be narrow, and not plowed at all.

The Benefit of laying up strong deep Land into Ridges is very great; tho' there be no Springs in it, as are in the Hills aforementioned.

This Land, when it lies flat, and is plowed sometimes one Way, sometimes the other, by cross-plowing, retains the Rain-water a long time soaking into it; by that Misfortune, the Plough is kept out Two or Three Weeks longer than if the same were in round Ridges; nay, sometimes its Flatness keeps it from drying till the Season of plowing, and even of sowing too, be lost.

The Reasons commonly given against such Ridges are these following.

- I. *They prevent the fabled Benefit of cross-plowing.*
- II. *Farmers think they lose Part of their Ground, by leaving more Furrows betwixt Ridges, than when they lay their Land flat, where the Lands are made much larger than round Ridges can conveniently be; and because also the Furrows betwixt Ridges must be broader, and lie open; but the other they fill up by the Harrows.*

The first of these I have already answered elsewhere, by shewing, that Cross-plowing is oftener injurious than beneficial.

The Second I shall sufficiently confute, if I can make appear, that no Ground is lost, but much may be gained, by Ridges.

What I mean by gaining of Ground, is the increasing of the Earth's Surface: For if a flat Piece be plow'd up into Ridges, and if in each Sixteen Feet Breadth there be an empty Furrow of Two Feet; and yet, by the Height and Roundness of the Ridges, they have Eighteen Feet of Surface capable of producing Corn, equally to Eighteen Feet whilst the Piece was flat; there will be one Eighth Part of profitable Ground or Surface gain'd, more than it had

when level; and this, I believe, Experience will prove, if the thing were well examined into.

But against this Increase of profitable Ground, there is an Objection, which I must not call a frivolous one, in respect to the Authors who bring it; yet, I hope, the Desire of finding the Truth will justify me to examine it; and the Arguments brought to sustain it.

This Opinion of theirs is founded upon their Notion (which I think very erroneous) of the perpendicular Growth of Vegetables; and is, by Mr. *Bradley*, set in its best Light, in his *Vol. I. Pag. 8. usque ad Pag. 13.* and in his Cuts, representing Three Hills; but his Arguments seem to be such as all Arguments are, which pretend to prove a thing to be what it is not; *viz.* Sophistical ones.

The Hypothesis he endeavours to prove, is in *Pag. 8.* thus: ‘ An Hill may contain Four equal Sides, which meet in a Point at the Top; but the Contents of these Four Sides can produce no more, either of Grain or Trees, than the plain Ground, upon which the Hill stands, or has at its Base: and yet, by the Measure of the Sides, we find twice the Number of Acres, Roods, and Poles, which measure in the Base, or Ground-plat; and therefore *Page 9.* Hills are worth no more than half their Superficial Measure; *i. e.* Two Acres upon the Side of the Hill to pay as much as one upon the Plain, provided the Soil of both is equally rich.’

To prove it, he gives an Example in *Fig. III.* of Buildings upon an Hill; shewing, that the Two Sides of the Hill will only bear the same Number of Houses, that may stand in the Line at the Base.

This is foreign to the Question, of how much Grain, or how many Trees, the Hill will produce. For Vegetables, being fed by the Earth, require much more of its Surface to nourish them, than is necessary for them to stand on; but Buildings require no more
of

of the Surface but Room to stand on: Therefore no such Argument, taken from Buildings, can be applied to Vegetables.

This Argument of Mr. *Bradley's* gives no more Satisfaction to the Question about producing of Vegetables, than a *Grazier* would do, being asked, how many Oxen a certain Pasture-ground would maintain, if he should answer, by satisfying you with the Number of Churches which might stand thereon.

The like Answer, in effect, may be given to the Argument in *Fig. IV.* of the Pales; only he has forgot to shew, that to mound over the Hill would require double the Rails, or double the Hedge-wood (except Stakes) as to mound the Base; if it did not, the Hill would be yet of the more Value, because thereon more Surface might be fenced in at less Expence.

In his *Fig. II.* he gives no good Reason why the Hill should not bear twice the Number of Trees as the Base can do; for there is as much Room for Two hundred Trees on the Hill, as for One hundred on the Base, because he allows the Surface to be double to that of the Base. He ought to measure the Distances of the Trees on the Hill, by a Line parallel to the Surface they grow on, as well as he does the Distances of those below.

And suppose the Row at the Base, together with the Surface they grow on, were rais'd up, so that it should become parallel to half the Row on the Hill, would not the Trees in the Base Row be twice as near to one another as the Trees in the Hill Row are? And suppose a Line had been ty'd from the Tops of all the lower Trees, before the Row was so rais'd up at one End, and then, after the Situation of the Row was so alter'd, if by this Line the Trees should be pull'd from being perpendicular to the Surface they grow on, and made to stand oblique to that, and perpendicular to the Horizon, as the upper Trees are; would the Distances of the Trees from one another be
alter'd

alter'd by this Change of Posture? No, for their Bottoms would be at the same Distances, because not removed; and their Tops, because the same Line holds them, at the same Distances in both Postures.

Mr. *Bradley's* Lines, drawn from the Trees below, which are one Perch asunder, make the Two Rows of Trees falsely seem to be at equal Distances, because these Lines are parallel to each other: But this is a Deceit; for, in Truth, the Distances of the Trees are not measured by the Distances of those Lines, but by the extreme Points at the Ends of the Lines (*a*); and those Two Points above, where the Lines cut the Row obliquely, and at unequal Angles are twice as far asunder as the endmost or extreme Points below are, where the Lines cut the Row at right Angles. Hence may be inferr'd, that there is Room for twice as many Trees to grow on the Hill as on the Base, and twice as much Grain for the same Reason; because there is twice the Surface for the Roots to spread in. And since Mr. *Bradley* allows the Hill to contain Two Perches to One of the Base, and the Soil of both to be of equal Goodness; and yet affirms, that the Two can produce no more of Grain or Trees than the one Perch can; I cannot see, why it should not be as reasonable to say, that Two Quarters of Oats will maintain an Horse no longer, nor better, than One Quarter of Oats, of equal Goodness, will do.

In *Page 13.* he concludes thus: ' That Hills, in their Measure, contain only as much profitable Land as the Plain or Plat of Ground they stand upon; and as a Proof of that, all Vegetables or Plants have an erect Method of Growth.'

This Proof of Mr. *Bradley's* is founded upon an Argument which has no Consequence, unless it were

(*a*) These upper Trees are measured by the unequal Length of the Lines, not by their parallel Distance, as the lower Trees are; therefore his Measure is a Quibble.

first proved, that the Surface of Earth could produce and maintain as many Vegetables or Plants as could stand thereon in an erect Posture; which Supposition is as impossible, as that half an Acre should produce and maintain and Hecatomb, without Mr. *Bradley's* teaching Oxen to live upon Air for their Food, as he thinks *Van Helmont's* Tree did.

All expert Husbandmen must needs be convinced, that the greatest Crop of Vegetables that ever grew, might stand in an erect Posture, upon a twentieth (and I may say the Hundredth) Part of the Surface that produced it; therefore there must be Nineteen Parts for the Roots to spread, unoccupied by the Trunks Stems, or Stalks.

And tho' it be true, than an Hill will support no more of these, than its Base, when placed in an erect Posture, close together, as in a Sheaf; yet this close Position is only proper for them when they are dead, and require no more Nourishment than Houses and Pales do; and consequently require no Room but to stand on. Therefore this Argument of Mr. *Bradley's* must not be admitted in vegetative Growth, where there is always required Nineteen times more Room in the Surface, for the Use of the Roots, than what the Stems, Trunks, or Stalks, do possess upon it: And the more Room there is for the Roots, the greater Number of Plants may be produced.

Neither can I admit, that all Vegetables or Plants have an erect Method of Growth; because the contrary is seen in Chamomile, and divers other Vegetables, which have an horizontal Method of Growth.

But what is more material to this Purpose, to be observed, is, that all Vegetables have horizontal Roots, and Roots parallel to the Earth's Surface or Superficies; and unless those Roots have a sufficient Superficies of Earth to range in, for Nourishment of a Plant, the Stem and Branches cannot prosper, what-

whatever be their Method of Growth above the Earth; and if there be not a due Quantity of Food for the Roots within the Earth, a very little Space may contain the external Parts of Vegetables upon it.

From what has been said, I think we may conclude, that Mr. *Bradley's* Hill may produce more Vegetables than the Base whereon it stands; and therefore it is of more Value than half its superficial Measure; *i. e.* Two Acres on the Hill are worth more than one Acre on the Plain, the Soil being equally rich, as he allows it to be, in his Case.

Now, indeed, whether Mr. *Bradley* might not possibly be deceived in his Opinion of the equal Richness of his Hill, and his Plain, I will not dispute: I will only say this, that 'tis generally otherwise. But where a Plain is plow'd up into moderate Ridges, their Height being in proportion to the Depth of the Staple, below which the Plough must take nothing into the Ridges, the Soil is equally rich, whether it be plowed plain, or ridged up. And as the Surface is in the Ridges increased, there is nothing in all Mr. *Bradley's* Arguments, that shews, why that increased Surface should not produce more Vegetables than the same Earth could do whilst it was level.

There are other Reasons why it should produce more when ridged (*a*), besides the Increase of Surface; as,

I. 'Tis then more free from the Injuries of too much Water.

(*a*) To the Three we may add a Fourth Reason, *viz.* the raising the Thickness of the Staple in the Ridges, keeping the Surface drier in wet Weather, and moister at the Bottom of the Staple in dry Weather. And I have seen Barley that was drilled on my raised little Ridges flourish in a dry Summer on the Brow of my chalky Hill, and on my lowest Land in wet Weather, when the Barley hand-sown contiguous to it on each Side those Ridges, sown on the Level the same Day that the Ridges were drilled, have looked yellow and sickly; and yet it is not wet Land.

II. 'Tis better protected against cold Winds; because the Ridges are a Shelter to one another.

III. If the Surface be much exhausted, by too frequent Sowing, the Ridges may be made just where the Furrows were, and then the Surface will be intirely changed.

The following general Rules ought to be observed about Ridges; viz.

That, as to their Height, regard must be had to the Nature of the Soil, in its difficult Admission of Water; for the greater that is, the greater Declivities the Ridges should have; and then, if the Soil be not deep, they should generally be made the narrower.

There is one thing which Mr. *Bradley* takes no notice of; viz. That no more of the Rain, or other Benefits of the Atmosphere, which descend perpendicularly, can fall on an Hill, or on a Ridge, than what would fall on the Base, or Ground-plot. But 'tis probable, that more of the fine Vapour, which swims in the Current of the Air horizontally, does strike and break against those Eminences, and so make an Equivalent (*b*), except that it runs off more quickly.

Notwithstanding all I have here said, in behalf of Ridges, I must confess, that, for my Hoeing-Husbandry, I should prefer Land that is naturally dry enough, without a Necessity of being laid up in any larger or higher Ridges than what may contain Six Feet in Breadth (*c*), that Size being the largest that is proper for the regular Operation of the Horse-hoe.

CHAP.

(*b*) But though Ridges do alter or increase the Surface, the Quantity of Soil or Earth remaining the same as on the Level, and of no greater Depth than can be tilled, it may produce equal Crops of Corn with the Level, and no more; except from the Advantage the Ridges may give it in lying drier.

(*c*) Since the Printing of my Essay, I find, upon Trial, that these narrow Ridges are as effectual as any for carrying the Water off from my clayey Hill; and that they be made much less
horizontal

C H A P. XVII.

Of Differences *between the Old and the New Husbandry.*

IN order to make a Comparison between the Hoeing-Husbandry, and the old Way, there are Four Things, whereof the Differences ought to be very well considered.

- | | |
|--|--------------|
| I. <i>The Expence</i> | } of a Crop. |
| II. <i>The Goodness</i> | |
| III. <i>The Certainty</i> | |
| IV. <i>The Condition in which the Land is left after a Crop.</i> | |

The Profit or Loss arising from Land, is not to be computed, only from the Value of the Crop it produces; but from its Value, after all Expences of Seed, Tillage, &c. are deducted.

Thus, when an Acre brings a Crop worth *Four Pounds*, and the Expences thereof amount to *Five Pounds*, the Owner's Loss is *One Pound*; and when an Acre brings a Crop which yields *Thirty Shillings*, and the Expence amounts to no more than *Ten Shillings*, the Owner receives *One Pound*, clear Profit, from this Acre's very small Crop, as the other loses *One Pound* by his greater Crop.

horizontal than broad Ridges, whereby their Furrows are the more easily turned upwards against the Declivity.

I have not tried any narrower Ridge than that of Six Feet upon this Hill: But I have had full Experience of Five-feet and of Four-feet Ridges upon other Land; and find that all Sizes of these narrow Ridges are very advantageous, even where the Crop is to be sown upon the Level; for fewer Furrows are necessary for the Tilling of an Acre, when 'tis kept in such Ridges, than in broad Lands; and after wet Weather the Ridges will be fit to be plowed much sooner than level Ground.

The usual Expences of an Acre of Wheat, sown in the old Husbandry, in the Country where I live, is, in some Places, for Two Bushels and an half of Seed; in other Places Four Bushels and an half; the least of these Quantities at Three Shillings per Bushel, being the present Price, is Seven Shillings and Six-pence. For Three Plowings, Harrowing, and Sowing, Sixteen Shillings; but if plow'd Four times, which is better, One Pound. For Thirty Load of Dung, to a Statute Acre, is Two Pounds Five Shillings. For Carriage of the Dung, according to the Distance, from Two Shillings to Six-pence the Load, One Shilling being the Price most common, is One Pound Ten Shillings. The Price for Weeding is very uncertain; it has sometimes cost Twelve Shillings, sometimes Two Shillings per Acre.

	l.	s.	d.
In Seed and Tillage, nothing can be abated of — — — } 01 03 06			
For the Weeding, one Year with another, is more than — — } 00 02 00			
For the Rent of the Year's Fallow 00 10 00			
For the Dung; 'tis in some Places a little cheaper, neither do they always lay on quite so much; therefore abating 15s. in that Article, we may well set Dung and Carriage at — — — } 02 10 00			
Reaping commonly 5s. sometimes less 00 04 06			
Total	04	10	00

Folding of Land with Sheep is reckoned abundantly cheaper than Cart-dung; but this is to be questioned, because much Land must lie still for keeping a Flock (unless there be Downs); and for their whole Year's keeping, with both Grass and Hay, there are but Three Months of the Twelve wherein the Fold is of any considerable Value; this makes the Price of their Manure

quadruple to what it would be, if equally good all the Year, like Cart-dung: And folding Sheep yield little Profit, besides their Dung; because the Wool of a Flock, except it be a large one, will scarce pay the Shepherd and the Shearers. But there is another thing yet, which more inhances the Price of Sheep-Dung; and that is, the dunging the Land with their Bodies, when they all die of the Rot, which happens too frequently in many Places; and then the whole Crop of Corn must go to purchase another Flock, which may have the same Fate the ensuing Year, if the Summer prove wet; and so may the Farmer be served for several more successive Years, unless he should break, and another take his Place, or that dry Summers come in time to prevent it. To avoid this Misfortune, he would be glad to purchase Cart-dung at the highest Price, for supplying the Place of his Fold; but 'tis only near Cities, and great Towns, that a sufficient Quantity can be procured.

But, supposing the Price of Dunging to be only Two Pounds Ten Skillings, and the general Expence of an Acre of Wheat, when sown, at Three Skillings per Bushel, to be Four Pounds Ten Skillings, with the Year's Rent of the Fallow;

The Expences of planting an Acre of Wheat in the Hoeing-Husbandry, is Three Pecks of (a) of Seed, at Three Skillings per Bushel, is Two Skillings and Three-pence. The whole Tillage, if done by Horses, would be Eight Skillings; because our Two Plowings, and Six Hoeings (b), are equal to Two Plowings;

(a) Sometimes half a Bushel is the most just Quantity of Seed, to drill on an Acre.

(b) But we sometimes plow our Six-foot Ridges before Drilling, at Five or Six Furrows, which is a Furrow or Two more than I have reckoned: But we do not always hoe Six times afterwards. But it is better for successive Wheat crops to bestow the Labour of as many Hoeings as amount to three plain Plowings in a Year, it being a greater Damage to omit one necessary Hoeing, than is the Expence of several Hoeings.

the common Price whereof is *Four Skillings* each; but this we diminish half, when done by Oxen kept on St. Foin, in this manner; *viz.* Land worth *Thirty Skillings* Rent, drill'd with St. Foin, will well maintain an Ox a Year (*a*), and sometimes Hay will be left to pay for the Making: We cannot therefore allow more than *One Shilling* a Week for his Work, because his Keeping comes but to *Seven-pence* a Week round the Year.

In plain Plowing, Six Feet contains Eight Furrows; but we plow a Six-foot Ridge at Four Furrows, because in this there are Two Furrows cover'd in the Middle of it, and one on each Side of it lies open. Now what we call one Hoeing, is only Two Furrows of this Ridge, which is equal to a Fourth Part of one plain Plowing; so that the Hoeing of Four Acres requires an equal Number of Furrows with one Acre that is plow'd plain, and equal Time to do it in (except that the Land, that is kept in Hoeing, works much easier than that which is not).

All the Tillage we ever bestow upon a Crop of Wheat that follows a ho'd Crop, is equal to Eight Hoings (*b*); Two of which may require Four Oxen each, One of them Three Oxen, and the other Five Hoings Two Oxen each. However, allow Three Oxen to each single Hoeing, taking them all one with another, which is Three Oxen more than it comes to in the Whole.

(*a*) Or an Ox may be well kept Nine Months, with an Acre of indifferent Horse-ho'd Turneps; and if we value them only at the Expence and Rent of the Land, this will be a yet cheaper Way of maintaining Oxen. Upon more Experience it is found, that St. Foin Hay alone, or with a small Quantity of Turneps, is best for working Oxen in the Winter; but a Plenty of Turneps with the same Hay is better for fattening Oxen that do not work.

(*b*) But the Number of Oxen required will be according to their Bigness and Strength, and to the Depth and Strength of the Soil, which also will be the easier Draught for the Oxen, the oftener the Intervals are hoed.

Begin at Five in the Morning, and in about Six Hours you may hoe Three Acres, being equal in Furrows to Three Rood; *i. e.* Three Quarters of an Acre. Then turn the Oxen to Grass, and after resting, eating, and drinking, Two Hours and an half, with another Set of Oxen begin Hoeing again; and by or before half an Hour after Seven at Night, another like Quantity may be ho'd. These are the Hours the Statute has appointed all Labourers to work, during the Summer Half-year.

To hoe these Six Acres a Day, each Set of Oxen draw the Plough only Eight Miles and a Quarter, which they may very well do in Five Hours; and then the Holder and Driver will be at their Work of Plowing Ten Hours, and will have Four Hours and an half to rest, &c.

The Expence then of hoeing Six Acres in a Day, in this manner, may be accounted, at *One Shilling* the Man that holds the Plough, *Six-pence* the Boy that drives the Plough, *One Shilling* for the Six Oxen, and *Six-pence* for keeping the Tackle in Repair. The whole Sum for hoeing these Six Acres is *Three Shillings*, being *Six-pence per Acre (a)*.

They who follow the old Husbandry cannot keep Oxen so cheap, because they can do nothing without the Fold, and Store-sheep will spoil the St. Foin. They may almost as well keep Foxes and Geese together, as Store-sheep and good St. Foin. Besides, the sowed St. Foin cost Ten times as much the Planting as drill'd St. Foin does, and must be frequently manured, or else it will soon decay; especially upon all sorts of chalky Land, whereon 'tis most commonly
The

(a) But where there is not the Convenience of keeping Oxen, the Price of Hoeing with Horses is One Shilling each time.

When a Roller is used, which is less than a Hoeing, because one Person to lead is enough, and that may be a Boy; and once in an Interval may suffice; then 'tis less Labour than half a Hoeing; and for this we may well abate One Hoeing of the Eight.

The Expence of drilling cannot be much; for as we can hoe Six Acres a Day, at Two Furrows on each Six-foot Ridge, so we may drill Twenty-four Acres a Day, with a Drill that plants Two of those Ridges at once; and this we may reckon a *Peny Half-peny* an Acre. But because we find it less Trouble to drill single Ridges, we will set the Drilling, at most, *Six-pence per Acre*.

As every successive Crop (if well managed) is more free from Weeds than the preceding Crop; I will set it all together at *Six-pence (a)* an Acre for Weeding (*b*).

For a Boy or a Woman to follow the Hoe-plough, to uncover the young Wheat, when any Clods of Earth happen to fall on it, for which Trouble there is seldom necessary above once (*c*) to a Crop, *Two-pence* an Acre. *One Peny* is too much for Brine and Lime for an Acre.

Reaping this Wheat is not worth above half as much as the Reaping of a sown Crop of equal Value; because the drill'd standing upon about a Sixth Part of the Ground, a Reaper may cut almost as much of the Row at one Stroke, at he could at Six, if the same stood dispersed all over the Ground, as the sowed does; and because he who reaps sowed Wheat,

(*a*) This is when the Land has been well cleansed of Weeds in the preceding Crop, or Fallow, or both.

(*b*) This may be enough, if the Land be well cleansed the Year before, and considering that several Years in such there is no Occasion for Weeding at all: And as this Calculation is comparative with the old Way, we should examine the Price of weeding the sown Corn, which by the best Information I can get, was in the Year 1735. about 4*s.* per Acre for Weeding of Barley; and of Wheat, round about where I live, about 6*s.* and in *Wiltshire*, 15*s.* per Acre for their Wheat, amongst which much Damage is done by the Weeder's Feet, and yet some Weeds are left.

(*c*) But this Expence being so small, 'tis better that a Person should follow at every Hoeing, where we suspect, that any Damage may happen from any Earth's falling on, or pressing too hard against some of the Plants.

must reap the Weeds along with the Wheat; but the drilled has no Weeds; and besides, there go a greater Quantity of Straw, and more Sheaves, to a Bushel of the sowed, than of the drilled (*a*). And since some Hundred Acres of drilled Wheat have been reaped at *Two Shillings and Six-pence per Acre*, I will count that to be the Price.

The whole Expence of an Acre of drilled Wheat.

	<i>l.</i>	<i>s.</i>	<i>d.</i>
For Seed — — — — —	00	02	03
For Tillage — — — — —	00	04	00
For Drilling — — — — —	00	00	06
For Weeding — — — — —	00	00	06
For Uncovering — — — — —	00	00	02
For Brine and Lime — — — — —	00	00	01
For Reaping — — — — —	00	02	06
Total	<hr/>	<hr/>	<hr/>
	00	10	00
The Expence of an Acre of } sowed Wheat is — — — — — }	04	00	00
To which must be added, for the } Year's Rent of the Fallow }	00	10	00
Total	<hr/>	<hr/>	<hr/>
	04	10	00

If I have reckoned the Expence of the drilled at the lowest Price, to bring it to an even Sum; I have also abated in the other more than the whole Expence of the drilled amounts unto.

And thus the Expence of a drilled Crop of Wheat is but the Ninth Part of the Expence of a Crop sown in the common Manner.

'Tis also some Advantage, that less Stock is required where no Store-sheep are used.

(*a*) One Sheaf of the latter will yield more Wheat than Two of the former of equal Diameter.

II. *Of the different Goodness of a Crop.*

The Goodness of a Crop consists in the Quality of it, as well as the Quantity; and Wheat being the most useful Grain, a Crop of this is better than a Crop of any other Corn, and the ho'd Wheat has larger Ears (and a fuller Body) than sow'd Wheat. We can have more of it, because the same Land will produce it every Year, and even Land, which, by the Old Husbandry, would not be made to bear Wheat at all: So that, in many Places, the New Husbandry can raise Ten Acres of Wheat for One that the Old can do: because where Land is poor, they sow but a Tenth Part of it with Wheat.

We do not pretend, that we have always greater Crops, or so great as some sown Crops are, especially if those mention'd by Mr. *Houghton* be not mistaken.

The greatest Produce I ever had from a single Yard in Length of a double Row, was Eighteen Ounces: The Partition of this being Six Inches, and the Interval Thirty Inches, was, by Computation, Ten Quarters (or Eighty Bushels) to an Acre.

I had also Twenty Ounces to a like Yard of a Third successive Crop of Wheat; but this being a treble Row, and the Partitions and Interval being wider, and supposed to be in all Six Feet, was computed to Six Quarters to an Acre. And if these Rows had been better order'd than they were, and the Earth richer, and more pulveriz'd, more Stalks would have tillered out, and more Ears would have attained their full Size, and have equal'd the best, which must have made a much greater Crop than either of these were.

But to compare the different Profit, we may proceed thus: The Rent and Expence of a drill'd Acre being One Pound, and of a sow'd Acre Five Pounds; One Quarter of Corn, produced by the drill'd, bears an equal Proportion in Profit to the One Pound, as Five Quarters, produced by the other, do to the Five Pounds,

Pounds. As suppose it be of Wheat, at Two Shillings and Six-pence a Bushel, there is neither Gain nor Loss in the one nor the other Acre, though the former yield but One Quarter, and the other Five; but if the drill'd Acre yield Two Quarters, and the sow'd Acre Four Quarters at the same Price, the drill'd brings the Farmer One Pound clear Profit, and the sown, by its Four Quarters, brings the other One Pound Loss. Likewise suppose the drilling Farmer to have his Five Pounds laid out on Five Acres of Wheat, and the other to have his Five Pounds laid out on One dung'd Acre; then let the Wheat they produce be at what Price it will, if the Five Acres have an equal Crop to the one Acre, the Gain or Loss must be equal: But when Wheat is cheap, as we say it is when sold at Two and Six-pence a Bushel, then if the Farmer, who follows the old Method, has Five Quarters on his Acre, he must sell it all to pay his Rent and Expence; but the other having Five Quarters on each of his Five Acres, the Crop of One of them will pay the Rent and Expence of all his Five Acres (*a*), and he may keep the remaining Twenty Quarters, till he can sell them at Five Shillings a Bushel, which amounts to Forty Pounds, wherewith he may be able to buy Four of his Five Acres at Twenty Years Purchase, out of One Year's Crop, whilst the Farmer who pursues the old Method, must be content to have only his Labour for his Travel; or if he pretends to keep his Wheat till he sells it at Five Shillings a Bushel, he commonly runs in Debt to his Neighbours, and in Arrear of his Rent; and if the Markets do not rise in time, or if his Crops

(*a*) Or suppose a drill'd Acre to produce no more than One Third of the sow'd Acre's Crop, whose Expence is Five times as much as of the drill'd, 'tis much more profitable, because a Third of Five Pounds is One Pound Thirteen and Four-pence; and a Fifth of the Rent and Expence being only One Pound, such drill'd Acre pays the Owner Thirteen and Four-pence more Profit, than the other which brings a Crop treble to the drill'd.

fail in the Interim, his Landlord seizes on his Stock, and then he knows not how it may be sold; Actions are brought against him; the Bailiffs and Attorneys pull him to Pieces; and then he is undone (a).

III. *The Certainty of a Crop.*

The Certainty of a Crop is much to be regarded; it being better to be secure of a moderate Crop, than to have but a mere Hazard of a great one. The Farmer who adheres to the old Method is often deceiv'd in his Expectation, when his Crop at coming into Ear is very big, as well as when 'tis in Danger of being too little. Our hoeing Farmer is much less liable to the Hazard of either of those Extremes; for when his Wheat is big, 'tis not apt to lodge or fall down, which Accident is usually the utter Ruin of the other; he is free from the Causes which make the contrary Crop too little.

A very effectual Means to prevent the failing of a Crop of Wheat, is to plow the pulveriz'd Earth for Seed early, and when 'tis dry. The early Season also is more likely to be dry than the latter Season is.

1. *The Advocate for the old Method is commonly late in his sowing; because he can't fallow his Ground early, for fear of killing the Couch, and other Grass that maintains his folding Sheep, which*
2. *are so necessary to his Husbandry: And when 'tis sow'd late, it must not be sow'd dry, for then the*
3. *Winter might kill the young Wheat. Neither can he at that time plow dry, and sow wet, because he commonly sows under Furrow; that is, sows the Seed first, and plows it in as fast as 'tis sown. If he*
4. *sows early (as he may if he will) in light Land, he must not sow dry, for fear the Poppies and other Weeds should grow, and devour his Crop; and if his*
5. *Land be strong, let it be sown early, wet or dry (tho'*

(a) Tho' only Five Acres and one Acre be put, yet we may imagine them Two hundred and Fifty, and Fifty to enrich the one, or break the other Farmer.

- wet is worst), 'tis apt to grow so stale and hard by Spring, that his Crop is in Danger of Starving, unless the Land be very rich, or much dung'd: and then the Winter and Spring proving kind, it may not be in less Danger of being so big as to fall down, and be spoil'd.
6. Another thing is, that though he had no other Impediment against plowing dry, and sowing wet, 'tis seldom that he has time to do it in; for he must plow all his Ground, which is Eight Furrows in Six Feet;
 7. and, whilst it is wet, must lie still with his Plough. When he sows under Furrow, he fears to plow deep, lest he bury too much of his Seed; and if he
 8. plows shallow, his Crop loses the Benefit of deep plowing, which is very great. When he sows upon
 9. Furrow (that is after 'tis plow'd) he must harrow the Ground level to cover the Seed; and that exposes the Wheat the more to the cold Winds, and suffers the Snow to be blown off it, and the Water to lie longer on it; all which are great Injuries to it.

Our Hoeing Husbandry is different in all of the fore-mentioned Particulars.

1. We can plow the Two Furrows whereon the next Crop is to stand, immediately after the present Crop is off.

2. We have no Use of the Fold; because our Ground has annually a Crop growing on it, and it must lie still a Year, if we would fold it, and that Crop would be lost; and all the Good the Fold could do to the Land, would be only to help to pulverize it for one single Crop; its Benefit not lasting to the Second Year. And so we should be certain of losing one Crop for the very uncertain Hopes of procuring one the ensuing Year by the Fold; when 'tis manifest by the adjoining Crops, that we can have a much better Crop every Year, without a Fold, or any other Manure.

3. We can plow dry, and drill wet, without any manner of Inconvenience.

4. He

4. He fears the Weeds will grow, and destroy his Crop: We hope they will grow, to the end we may destroy them (*a*).

5. We do not fear to plant our Wheat early (so that we plow dry), because we can help the Hardness or Staleness of the Land by Hoeing.

6. The Two Furrows of every Ridge whereon the Rows are to be drilled, we plow dry; and if the Weather prove wet before these are all finished, we can plow the other Two Furrows up to them, until it be dry enough to return to our plowing the first Two Furrows; and after finishing them, let the Weather be wet or dry, we can plow the last Two Furrows. We can plow our Two Furrows in the Fourth Part of the Time they can plow their Eight, which they must plow dry all of them, in every Six Feet; for they cannot plow part dry, and the rest when 'tis wet, as we can.

7. We never plant our Seed under Furrow, but place it just at the Depth which we judge most proper; and that is pretty shallow, about Two Inches deep; and then there is no Danger of burying it.

8. We not only plow a deep Furrow, but also plow to the Depth of Two Furrows; that is, we trench-plow where the Land will allow it (*b*); and we have the greatest Convenience imaginable for doing this, because there are Two of our Four Furrows

(*a*) For, before they grow, they cannot be killed; but if they are all killed as soon as they appear, there will be no Danger of their exhausting the Land, or re-stocking it with their Seed; and 'tis our Fault if we drill more than we can keep clean from Weeds by the Horse-hoe, Hand-hoe, and Hands; the First for the Intervals, the Second for the Partitions, and the Third for the Rows: By the Two former, as soon after they appear as they can; but by the last, when they are grown high enough to be conveniently taken hold of.

(*b*) Very little of my Land will admit the Plough to go the Depth of Two common Furrows without reaching the Chalk; But deep Land may be easily thus Trench-plowed with great Advantage; and even when there is only the Depth of a single Furrow, that may sometimes be advantageously plowed at twice.

always

always lying open ; and Two plowed Furrows (that is, one plowed under another) are as much more advantageous for the nourishing a Crop, as Two Bushels of Oats are better than one for nourishing an Horse : Or if the Staple of the Land be too thin or shallow, we can help it by raising the Ridges prepared for the Rows the higher above the Level.

9. We also raise an high Ridge in the Middle of each Interval above the Wheat before Winter, to protect it from the cold Winds, and to prevent the Snow from being driven away by them. And the Furrows or Trenches, from whence the Earth of these Ridges is taken, serve to drain off the Water from the Wheat, so that, being drier, it must be warmer than the harrowed Wheat, which has neither Furrows to keep it dry, nor Ridges to shelter it (*a*), as every Row of ours has on both Sides of it.

IV. *The Condition in which the Land is left after a Crop.*

The different Condition the Land is left in after a Crop (*b*), by the one and the other Husbandry, is
not

(*a*) This is a Mistake ; for the Ridges in the Middle of the Intervals do not always, nor often in thin shallow Land lie high enough to make a Shelter to the Rows, they being higher : But when Wheat is drilled on the Level, 'tis sheltered by the Ridges raised in the Intervals : But we never weed or hand-hoe Wheat before the Spring.

(*b*) If indifferent Land be well pulverized by the Plough for one whole Year, it will produce a good Crop : But then, if, instead of being sown, it be kept pulverized on for another Year without being exhausted by any Vegetables, it will acquire from the Atmosphere an extraordinary great Degree of Fertility more than it had before such Second Year's Pulveration and Unexhaustion. This being granted, which no Man of Experience can deny, what Reason can there be why such a Number of Plants, competent for a profitable Crop, may not be maintained on it the Second Year, that may keep the Degree of their Exhaustion in *Equilibrio* with that Degree of Fertility, which the same Land had acquired at the End of the First Year of its Pulveration, the same Degree of Pulveration being continued to it by Hoeing in the Second Year ? Or why may it not produce annual Crops always, if the same *Equilibrium* be continually kept ? Two unanswerable

not less considerable than the different Profit of the Crop.

A Piece of Eleven Acres of a poor, thin, chalky Hill was sown with Barley in the common Manner, after a hoed Crop of Wheat; and produced full Five Quarters and an half to each Acre (reckoning the Tythe); which was much more than any Land in all the Neighbourhood yielded the same Year; tho' some of it be so rich, as that One Acre is worth Three Acres of this Land: And no Man living can remember, that ever this produced above half such a Crop before, even when the best of the common Management has been bestowed upon it.

A Field, that is a sort of an Heath-ground, used to bring such poor Crops of Corn, that heretofore the Parson carried away a whole Crop of Oats from it, believing it had been only his Tythe. The best Management that ever they did or could bestow upon it, was to let it rest Two or Three Years, and then fallow and dung it, and sow it with Wheat, next to that with Barley and Clover, and then let it rest again; but I cannot hear of any good Crop that it ever produced by this or any other of their Methods; 'twas still reckoned so poor, that nobody cared to rent it. They said Dung and Labour were thrown away upon it, then immediately after Two sown Crops of black Oats had been taken off it, the last of which was scarce worth the mowing, it was put into the

several Reasons may be given why this *Equilibrium* cannot be kept in the random Sowing, as it may in the Hoeing Method; *viz.* First, In the former, the Land is by the Number of sown Plants and Weeds much more (we may suppose at least Five times more) exhausted: And, Secondly, No Pulveration is continued to the Soil, whilst the Crop is on it; which is that Part of the Year wherein is the most proper (if not the only proper) Season for pulverizing. Therefore, allowing, that, in the random way, a Soil cannot, for want of Quantity of vegetable Food, continue to produce annual Crops without Manure, or perhaps with it; yet that is no Reason why it may not produce them in the Hoeing Culture duly performed.

Hoing Management; and when Three hoed Crops (*a*) had been taken from it, it was sown with Barley, and brought a very good Crop, much better than ever it was known to yield before; and then a good Crop of hoed Wheat succeeded the Barley, and then it was again sown with Barley, upon the Wheat-stubble; and that also was better than the Barley it used to produce.

Now all the Farmers of the Neighbourhood affirm, that it is impossible but that this must be very rich Ground, because they have seen it produce Six Crops in Six Years, without Dung or Fallow, and never one of them fail. But, alas! this different Reputation they give to the Land, does not at all belong to it, but to the different Sorts of Husbandry; for the Nature of it cannot be altered but by that, the Crops being all carried off it, and nothing added to supply the Substance those Crops take from it, except (what Mr. *Evelyn* calls) the celestial Influences; and that these are received by the Earth, in proportion to the Degrees of its Pulveration.

A Field was drilled with Barley after an hoed Crop; and another adjoining to it on the same Side of the same poor Hill, and exactly the same Sort of Land, was drilled with Barley also, Part of it after the sown Crop, the same Day with the other; there was only this Difference in the Soil, that the former of these had no manner of Compost on it for many Years before, and the latter was dunged the Year before: Yet its Crop was not near so good as that which followed the hoed Crop (*b*); tho' the latter had twice the Plowing that the former had before drilling, and the same Hoings afterwards; viz. Each was hoed Three times.

A Field of about Seventeen Acres was Summer-fallowed, and drilled with Wheat; and with the Hoing brought a very good Crop (except Part of it,

(*a*) These Three hoed Crops were of Turneps and Potatoes.

(*b*) This was a Wheat Crop, and often well hoed.

which being eaten by trespassing Sheep in the Winter, was somewhat blighted); the *Michaelmas* after that was taken off, the same Field was drilled again with Wheat, upon the Stubble of the former, and hoed: This Second Crop was a good one, scarce any in the Neighbourhood better. A Piece of Wheat adjoining to it, on the very same Sort of Land (except that this latter was always reckoned better, being thicker in Mould above the Chalk), sown at the same time on dunged Fallows, and the Ground always dunged once in Three Years; yet this Crop failed so much, as to be judged, by some Farmers, not to exceed the Tythe of the other: That the hoed Field has received no Dung or Manure for many Years past, is because it lies out of the Reach for carrying of Cart-Dung, and no Fold being kept on my Farm: But I cannot say, I think there was quite so much Odds betwixt this Second undunged hoed Crop and the sown; yet this is certain, that the former is a good, and the latter a very bad Crop.

I could give many more Instances of the same Kind, where hoed Crops and sown Crops have succeeded better after hoed Crops than after sown Crops, and never yet have seen the contrary; and therefore am convinced, that the Hoeing (*a*) (if it be duly performed) enriches the Soil more than Dung and Fallows, and leaves the Land in a much better Condition for a succeeding Crop. The Reason I take to be very

(*a*) This is more especially meant of Fallows in the common Husbandry, and a moderate Quantity of common Dung, or the Fold: And there may be such a poor Sand, or other barrenish Soil, so subject to Constipation in the Winter, as to require Dung when planted with Wheat, there being no general Rule without Exceptions; and 'tis impossible for me to know the Number of these Exceptions. Well it is for the Hoer, whose Land is of such a kind, that he can keep it in Heart without Dung by Hoeing; for when he has no Fold, he plows his Ground with Oxen, and plants it mostly with Wheat, the Straw whereof being for other Uses, he can make but very little Dung.

obvious: The artificial Pasture of Plants is made and increased by Pulveration only; and nothing else there is in our Power to enrich our Ground, but to pulverize it (*a*), and keep it from being exhausted by Vegetables.

(*a*) These Two are all we have in our Power; for pulverizing includes an Exposure to the Atmosphere; without which, I think, it cannot be reduced to Particles minute enough, or have their Superficies so impregnated as to become a fertile Pasture for Plants. The Experiment related by Mr. *Evelyn* of artificial Pulveration, seems to prove such an Exposure necessary; as also the frequent turning (or incessantly agitating) that fine Dust for a Year, before the barren exhausted Earth was made rich and prolific: For, besides the Benefit of Pulveration and Impregnation, Land is more enriched in proportion to the Time of Exposure, during which it is free from Exhaustion, and continually receiving from the Atmosphere: Therefore frequent Turning and Exposure are both contained in the Words *pulverize, and not exhaust*; and to comply with the latter, we should endeavour, that our Land may be never exhausted by any other Plants than by those we would propagate, and by no more of them neither, than what are necessary for producing a reasonable Crop; which, upon full Trial, will be found a very small Number in comparison to those that are commonly sown; and then, if the Supply from the Atmosphere by Help of the Pulveration exceeds the Exhaustion, the Land will become richer, tho' constant Crops are produced of the same Species; as in the Vineyards; and the Soil of these is so much improved by a bare competent Exhaustion, and the usual Pulveration, that after producing good annual Crops without Durg, until Age has killed the Vines, they leave the Soil better than they found it; and better than contiguous Land of the same Sort kept in arable Field-culture.

By Pulveration are meant all the Benefits of it that accrue to the Pasture of Plants; and by Exhaustion, all the Injuries that can be done to that Pasture, except Burning. And as the Benefits of Pulveration visibly continue for several Years, so do the Injuries of Exhaustion; which appear by the Ends of some of my Rows that have been cleansed of Weeds in their Partitions by the Hand-hoe, and the other Ends of the same Rows not cleansed; the Difference is visible in the Colour of the Wheat in the Third and Fourth following Crops, equally managed; and this is no more to be wondered at, than that Two unequal Sums, being equally increased or diminished, should remain unequal, until an Addition to the lesser, or a Subtraction from the greater, be made; which, in case of the Soil, must be either by a greater Pulveration, or a lesser Exhaustion. 'Tis by this that both Ends
of

getables (*a*). Superinductions of Earth are an Addition of more Ground, or changing it, and are more properly purchasing than cultivating.

Their

of these Rows in time become equal: For tho' Ten Plants that produce an Ounce of Wheat, infume more *Pabulum* than one Plant that produces the same Quantity (the Reason for which is given in the Note on *p.* 121.); yet a Plant that produces Six or Seven Drams, infumes less than one that produces an Ounce; for a Plant which produces Six Drams of Wheat cannot be a poor one, and therefore infumes no more *Pabulum* than in proportion to its Augment and Product. Thus the Soil of those Ends, which, by being doubly exhausted by Weeds and Wheat plants, was made poorer, gradually recovers an Equality with the other Ends, by being for several Years less exhausted than the other Ends are by larger Plants, whilst the Number of Plants, and the Pulveration of each, are equal.

To the Reasons already given there is another to be added, why Horse hoed Wheat exhausts the Soil less than sown Crops, where the Product of Wheat produced by each is equal: Which Reason is, that the former has much less Straw than the latter; as appears by the different Quantities of Grain that a Sheaf of each of equal Diameter yields; one of the former yielding generally double to one of the latter; for a Sheaf of the sown has not only more small Under-ears, but also its best Ears bear a less Proportion to their Straw than the other; for a Straw of sown Wheat Six Feet high, I have found to have an Ear but of half the Size of an Ear of drilled Wheat on a Stalk Five Feet high, having measured both of them standing in the Field, and rubbed out the Grain of them. This Difference I impute to the different Supply of Nourishment at the time when the Ears are forming.

Thus the sown Crop exhausts a Soil much more by its greater Quantity of Straw.

And this is one Reason why annual Crops of sown Wheat cannot succeed as Crops of Horse hoed Wheat do. There must be Dung and Fallow to repair the Exhaustion of the sown; neither of which are necessary for Crops of the Horse-hoed.

(*a*) It may be asked, How 'tis possible that Eight Hoeings, which are but equal, in Labour, to Two plain Plowings, should so much exceed Three plain Plowings, as to procure as good or a better Crop without Manure, than the common Three Plowings can do with Manure, and enrich the Land also.

The Answer is, That each Hoeing of the Five or Six being done to the Wheat-plants, though it does not clean plow the whole Interval underneath, yet it changeth the whole external Superficies (or Surface) thereof, whereby it becomes impregnate

b.

Their One Year's Tillage, which is but Two Plowings before Seed-time, commonly makes but little Dust; and that which it does make, has but a short time to lie exposed for Impregnation; and after the Wheat is sown, the Land lies unmoved for near Twelve Months, all the while gradually losing its Pasture, by subsiding, and by being continually exhausted in feeding a treble Stock of Wheat-plants, and a Stock of Weeds, which are sometimes a greater Stock. This puts the Advocates for the old Method upon a Necessity of using of Dung, which is, at best, but a Succedaneum of the Hoe; for it depends chiefly on the Weather, and other Accidents, whether it may prove sufficient by Fermentation to pulverize in the Spring, or no: And it is a Question whether it will equal Two additional (a) Hoings, or but one; tho', as I have computed it, one Dinging costs the Price of One hundred Hoings.

When they have done all they can, the Pasture they raise is generally too little for the Stock that is to be maintained upon it, and much the greatest Part of the Wheat-plants are starved; for from Twenty Gallons of Seed they sow on an Acre, they receive commonly no more than Twenty Bushels (b) of Wheat in their Crop, which is but an Increase of Eight Grains for one: Now, considering how many Grains there are in one good Ear, and how many Ears

by the nitrous Air, as much as if it were all clean plowed at the time of every Hoing, and the Weeds are as much stifled, or suffocated.

(a) Additional, because there must first be several Hoings to make our treble Row equal to an undunged Six-foot Ridge of sown Wheat.

(b) And they have oftener less than Sixteen Bushels; and in the Harvest 1735, a substantial experienced Farmer had no more than Four Bushels of Wheat to an Acre throughout a Field of Forty Acres, being robbed by Poppies; and I have known a Crop that has amounted to do more than Two Bushels to an Acre, and some Crops less, tho' dinged and fallowed; so that, taking the common sown Crops of Wheat one with another, they are thought not to amount to Sixteen Bushels to an Acre, *communibus annis*.

on one Plant, we find, that there is not One Plant in Ten that lives till Harvest, even when there has not been Frost in the Winter sufficient to kill any of them; or if we count the Number of Plants that come up on a certain Measure of Ground, and count them again in the Spring, and likewise at Harvest, we shall be satisfied, that most or all of the Plants that are missing, could die by no other Accident than want of Nourishment.

They are obliged to sow this great Quantity of Seed, to the end that the Wheat, by the great Number of Plants, may be the better able to contend with the Weeds; and yet, too often, at Harvest, we see a great Crop of Weeds, and very little Wheat among them. Therefore this Pasture, being insufficient to maintain the present Crop, without starving the greatest Part of its Plants, is likely to be less able to maintain a subsequent Crop, than that Pasture which is not so much exhausted.

When their Crop of Wheat is much less than ours, their Vacancies, if computed all together, may be greater than those of our Partitions and Intervals; theirs, by being irregular, serve chiefly for the Protection of Weeds; for they cannot be plow'd out, without destroying the Corn, any more than Cannons firing at a Breach, whereon both Sides are contending, can kill Enemies, and not Friends.

Their Plants stand on the Ground in a confused manner, like a Rabble; ours like a disciplin'd Army: We make the most of our Ground; for we can, if we please, cleanse the Partitions with a Hand-hoe (*b*); and for the rest, if the Soil be deep enough to be drill'd on the Level (*c*), in treble Rows, the Par-

(*b*) Of all annual Weeds.

(*c*) This is only put as a Supposition; for I have for these several Years left off drilling on the Level, and do advise against it; because altho' Mould should not be wanting for the Partitions in deep rich Land, yet it is much more difficult to hoe on the Level than on kidges.

titions at Six Inches (*d*), the Intervals Five Feet; Five Parts in Six of the whole Field may be pulveriz'd every Year, and at proper times all round the Year.

The Partions being one Sixth-part for the Crop to stand on, and to be nourished in the Winter, one other Sixth-part being well pulveriz'd, may be sufficient to nourish it from thence till Harvest (*e*); the Remainder, being Two-thirds of the Whole, may be kept unexhausted, the One-third for one Year, and the other Third of it Two Years; all kept open for the Reception of the Benefits descending from above, during so long a time; whilst the sowed Land is shut against them every Summer, except the little time in which it is fallow'd, once in Three Years, and a little, perhaps, whilst they plow it for Barley in the Winter, which is a Season seldom proper for pulverizing the Ground.

Their Land must have been exhausted as well by those supernumerary Plants of Wheat, while they lived, as by those that remain for the Crop, and by the Weeds. Our Land must be much less exhausted, when it has never above one Third-part of the Wheat-plants to nourish that they have, and generally no Weeds; so that our ho'd Land having much more vegetable Pasture made, and continually renewed, to so much a less Stock of Plants (*f*), must needs be

(*d*) But when it is drilled upon Ridges, the Proportion is less, by how much the Partitions, being thicker in Mould, contain more than a Sixth-part of the whole Six Feet of Earth, and the Proportion of unexhausted Earth will be alter'd likewise; and I only mention these Distances to avoid Fractions.

(*e*) This may be done, tho' the Roots of a competent Number of Plants run through the Whole, in the manner herein before explained.

(*f*) Therefore, whenever a Soil receives more Supplies of fine Earth from the Atmosphere, than is exhausted by all the Plants that grow in the Soil, it becomes richer; but if the contrary, then it becomes poorer.

left, by every Crop, in a much better Condition than theirs is left in by any one of their sown Crops, altho' our Crops of Corn at Harvest be better than theirs (g).

They object against us, saying, That sometimes the Hoeing makes Wheat too strong and gross, whereby it becomes the more liable to the Blacks (or Blight of Insects): But this is the Fault of the Hoer; for he may choose whether he will make it too strong, because he may apply his Hoeings at proper times only, and apportion the Nourishment to the Number and Bulk of his Plants. However, by this Objection they allow, that the Hoe can give Nourishment enough, and therefore they cannot maintain, that there is a Necessity of Dung (b) in the Hoeing-Husbandry; and

(g) On an undung'd low Six feet Ridge, we have Three Rows, Eight Inches asunder, all which being equal, during the Winter, but each of the Two outside Rows at Harvest producing Ten times as much Wheat as the middle Row doth, all Three together produce a Quantity equal to One-and-twenty of this middle Row. Now, supposing the Roots of this Row not to reach through the outside Rows, so as to receive any Benefit from the ho'd Intervals, then this Row might only be equal to one of Nine Rows, which should have been drilled Eight Inches asunder on this Ridge, and then our Three would only be equal to Twenty-one of such Nine Rows. But since it can be demonstrated, that the Roots of our middle Row do pass through both the outside Rows far into the ho'd Intervals, we may well suppose it to be at least double to what it would have been, if it had no Benefit from the Hoeing, and then our Three will be equal to Forty-two of such Nine unho'd Rows. Thus our Crop is Thirty-three in Forty-two (or almost Four Parts in Five) increased by the Hoeing; for though many Fields of Wheat have been drilled all over in Rows Eight Inches asunder, it never has been judged, in Twenty Years Experience, that a Crop so planted, though not ho'd, was, by its Evenness and Regularity, less, *cæteris paribus*, than a Crop sown a random.

(b) As for the Quantity of vegetable Matter of Dung, when reduced to Earth by Putrefaction, it is very inconsiderable, and of many sorts of Manure, next to nothing.

The almost only Use of all Manure is the same as of Tillage: *viz.* the Pulveration it makes by Fermentation, as Tillage doth

and that, if our Crops of Wheat should happen to suffer, by being too strong, our Loss will be less than theirs, when that is too strong, since it will cost them Nine times our Expence to make it so.

A Second Objection is, That as Hoeing makes poor Land become rich enough to bear good Crops of Wheat for several Years successively, the same must needs make very good Land become too rich for Wheat. I answer, That if possibly it should so happen, there are Two Remedies to be used in such a Case; the one is to plant it with Beans, or some other Vegetables, which cannot be over-nourished, as Turneps, Carrots, Cabbages, and such-like, which are excellent Food for fattening of Cattle; or else they may make use of the other infallible Remedy, when that rich Land, by producing Crops every Year in the Hoeing-Husbandry, is grown too vigorous and resty, they may soon take down its Mettle, by sowing it a few Years in their old Husbandry, which will fill it again with a new Stock of Weeds, that will suck it out of Heart, and exhaust more of its Vigour, than the Dung (*i*), that helps to produce them, can restore.

There is a Third Objection, and that is, That the Benefit of some Ground is lost where the Hoe-plough turns at each End of the Lands: But this cannot be much, if any, Damage; because about Four Square

by Attrition or Contusion; and with these Differences, that Dung, which is the most common Manure, is apt to increase Weeds, a Tillage (of which Hoeing is chief) destroys them, and Manure is scanty in most Places, but Tillage may be had every-where. Another Difference is, the vast Disproportion of the Price of Manure and that of Tillage.

Note, As we have no way to enrich the Soil, but by Pulveration of Manure, or of Instruments, or of both; so Nature has ordain'd, that the Soil shall be exhausted by nothing, but by the Roots of Plants.

(*i*) Dung made of the Straw of sown Corn generally abounds with the Seed of Weeds.

Perch to a Statute Acre is sufficient for this Purpose; and that, at the Rate of *Ten Shillings* Rent, comes to but *Three-pence*, tho' this varies, according as the Piece is longer or shorter; and supposing the most to be Eight Perch, that is but *Six-pence per Acre*; and that is not lost neither; for whether it be of natural or artificial Grass, the Hoe-plough, in turning on it, will scratch it, and leave some Earth on it, which will enrich it so much, that it may be worth its Rent for Baiting of Horses or Oxen upon it. And besides, these Ends are commonly near Quick-hedges or Trees, which do so exhaust it, that when no Cattle come there to manure it, 'tis not worth the Labour of plowing it.

C H A P. XVIII.

Of PLOUGHS.

BY what means Ploughs and Tillage itself came at first to be invented is uncertain; therefore we are at Liberty to guess: And it seems most probable, that it was, like most other Inventions, found out by Accident, and that the first Tillers or Plowers of the Ground were Hogs: Men in those Days, having sufficient Leisure for Speculation, observ'd, that when any sort of Seed happen'd to fall on a Spot of Ground well routed up by the Swine (which Instinct had instructed to dig in Search of their Food), it grew and prospered much better than in the whole unbroken Turf. This Observation must naturally induce rational Creatures to the Contrivance of some Instrument, which might imitate, if not excel Brutes in this Operation of breaking and dividing the Surface of the Earth, in order to increase and better its Product.

That some such Accident gave Men the First Hints of *original Agriculture*, may be inferr'd from the very little (or no) Probability of its being invented originally upon Arguments which might convince the Understanding (by just Conclusions from Ideas of the Earth and Vegetation) of any reasonable Grounds to hope, that the Effect of increasing the Earth's Produce should follow the Cause of Tillage; or, in other Words, why it should produce more when tilled than when untilled. Therefore it is very unlikely, that Men should begin to take Pains to till the Land without any Sort of Reason why they did it. And no such Reason could they have before the Invention, as they had afterwards: For when they accidentally saw that Effect follow that Cause, then they were well convinced it did so. But tho' this Argument, *viz.* Tillage increases the Product of the Earth, because it does, has been sufficient to continue the Practice of Tillage ever since; yet it is impossible for the Inventors to have had this Argument before the Invention, in case it had been invented by Men, and not fortuitously discover'd.

Had there ever been extant any other or better Arguments, whereon this Practice, so useful to Mankind, was founded; sure, some of all the great and learned Authors, who have written on this Subject, would have mention'd them. Philosophers, Orators, and Poets, have treated of it in the same Theory by which it was first discover'd, and by no other; *viz.* Land produces more when tilled; and some seem to say, the more it is tilled, the more it produces. It does, because it does; not a Word of the Pasture of Plants, or any thing like it. So that all the antient *Scriptores de re rustica* have done, was only to keep that Theory in the same Degree of Perfection in which the first Discoverers received it.

The bristled Animals broke up the Ground, because they used to find their Food there by digging :
Men

Men till it, because they find Tillage procures them better Food than Acorns.

The Reasons are the same for one and the other.

These Writers, ashamed to acknowledge so noble a Discovery to be owing to so mean a Foundation, make no mention of the true Teachers, but attribute the Invention to *Ceres*, a Goddess of their own making; she, as they pretend, first taught the Art of Tillage. With this Fable they were so well pleased, that they never attempted to improve that Art, lest they should derogate from the Divinity of *Ceres*, in supposing her Invention imperfect.

With what Instrument Men first tilled the Ground we don't know exactly; but there may be Reasons to believe it was with the Spade, and probably a wooden one, and very rough.

For whilst People liv'd on Acorns, there was no need of the Smith; such Food required no Knives for eating it, nor was it worth while to make Swords to fight for it; and without Iron the Spade could not be well hewn, or shap'd; but if it had been such as it is at present, there never was any thing comparable to it, for the true Use of Tillage. Yet the Spade could not make that Expedition, which was necessary when Tillage became general in the Fields; and therefore in time the Spade came wholly to be appropriate to the most perfect Sort of Tillage in the Garden. Then the Plough supply'd the Place of the Spade in the Field; and tho' it could not (such as it was) till the Land near so well, yet it could till ten times more of it, and with less human Labour.

Why they did not improve the Plough, so that it might also till as well as the Spade, seems owing to their Primitive Theory, which gave no Mathematical Reason to shew wherein the true Method of Tillage did consist; viz. in dividing the Earth into many Parts, to increase its internal Superficies, which is the Pasture of Plants.

The Difference betwixt the Operation of the Spade, and that of the common Plough, is only this; that the former commonly divides the Soil into smaller Pieces, and goes deeper.

How easy and natural it is to contrive a Plough that may equal the Spade, if not exceed it, in going deeper, and cutting the Soil into smaller Pieces, than the Spade commonly does, I leave to the Judgment of those who have seen the Four-coulter'd Plough.

The Plough describ'd by *Virgil* had no Coulter; neither do I remember to have seen any Coulter in *Italy*, or the South of *France*; and, as I have been inform'd, the Ploughs in *Greece*, and all the *East*, are of much the same Fashion: Neither is it practicable to use a Coulter in such a Plough; because the Share does not cut the Bottom of the Furrow horizontally, but obliquely; in going one way, it turns off the Furrow to the right Hand; but in coming back, it turns it to the Left (*a*). Therefore, if it had a Coulter, it must have been on the wrong Side every other Furrow: And besides, as the Handle (for it has but one) always holds the Plough towards one Side, with the Bottom of the Share towards the unplow'd Land, it would cause the Coulter to go much too low when it went on the Furrow-side, and it would not touch the Ground, when it went on the Land-side.

'Tis a great Mistake in those who say *Virgil's* Plough had Two Earth-boards; for it had none at all; but the Share itself always going obliquely, served instead of an Earth-board; and the Two Ears, which were the Corners of a Piece of Wood lying under

(*a*) Note, This *Eastern* Plough always goes forward, and returns back in the same Furrow, making only one Land of a whole Field: Though it turns its one Furrow towards the Right, and the other towards the Left of the Holder; yet every Furrow is turned towards the same Point of the Compass, as when we plow with a Turn-wrist Plough.

the Share, did the Office of Ground-wrests: This Fashion continues to this Day in those Countries, and in *Languedoc*.

This sort of Plough performs tolerably when Ground is fine, and makes a shift to break up light Land; and I could never find any other Land there; I am sure none comparable to ours for Strength: And it would be next to impossible, to break up such as we in *England* call strong Land with it.

I do not find, that the Arable Lands about *Rome* are ever suffered to lie still long enough to come to a Turf; but I have observed in the low rich Lands in the *Calabria's*, subject to the Invasions of the *Turks*, that there is Turf, and that these Ploughs go over the Land Two or Three times before the Turf of it is all broken, tho' the Soil be a very mellow Sort of Garden-mould. Having no Coulters to cut it, they break and tear Turf into little Pieces. This was done in the Month of *November*; and had I not seen Men and Oxen at the Work, or had there been Oaks in the Place, I should rather have thought that Tillage performed by a Race of the first Teachers of it, in muzzling Acorns, than by Ploughs. However, the Mould being naturally very mellow, when the Turf is broken with shallow Plowing, they can plow deeper afterwards.

The *English* Ploughs are very different from the *Eastern*, as in general the Soil is.

These, when well made, cut off the Furrow at the Bottom horizontally; and therefore, it being as thick on the Land-side as on the Furrow-side, the Plough cannot break it off from the whole Land, at such a Thickness (being Six times greater than the *Eastern* Ploughs have to break off), and must of Necessity have a Coultter to cut it off: By this means the Furrow is turned perfectly whole, and no Part of the Turf of it broken; and if it lie long without new turning, the Grass from the Edges will spread,
and

and form a new Turf (or Swerd) on the other Side, which was the Bottom of the Furrow before turning, but is now become the Surface of the Earth, and may soon become greener with Grass than before Plowing; and often the very Roots send up new Heads to help to stock the reversed Furrow, the former Heads being converted into Roots, so that it is doubly cloathed and braced on both Sides, or, as it were, kay'd together, firm and solid, almost as a Plank; it may be drawn from one Side of a Field to the other without breaking, and might possibly be made use of, instead of *Virgil's Crates Viminea*, for harrowing or smoothing of fine-tilled Ground; but not without much Time, Labour, and Difficulty, can it be made such itself.

If you plow whole strong turfy Furrows cross-ways, as *Virgil* directs, and as it is too commonly practised, the Coulter cannot easily cut them, because, being loose underneath, they do not make a sufficient Resistance or Pressure against its Edge, but move before it, and so are apt to be drawn and driven up into Heaps, with their Surfaces lying all manner of Ways, and situate in all manner of Postures: So the Turf, which is not turned, continuing in the open Air, grows on, and with its vigorous Roots holds the Earth fast together, and will not suffer the necessary Division to be made, which would be, if the Turf were rotten, and which is the End of all Tillage, *viz.* to increase the Pasture of Plants.

Next, some have vast heavy Drags, with great long Iron Tines in them; and tho' these huge broken Pieces of Furrows, being looser than before, require keener Edges to cut them; yet these Drag-tines have no Edge at all, but are as blunt as the Furrows they should cut. These Drags draw them sometimes into larger Heaps, leaving the under *Stratum* bare betwixt them, only shaking off some of their Mould in tumbling them about, and scratching their Surfaces,
without

without reducing them to a moderate Fineness, until this ill-broken Land has, for above a Year, and sometimes longer, entertained Ploughs, Cattle, and Men, with a frequent laborious Exercise, for which they are obliged to the one Coulter.

If the Soil be shallow, it may be broken up with a narrow Furrow, which will the sooner be brought in Tith; but if it be a deep Soil, the Furrows must be proportionably large, or else a Part of the good Mould must be left under unmoved, and so lost; for a narrow Furrow cannot be plowed deep, because the Plough will continually slip out from the hard Land toward the Right-hand, unless the rising Furrow be of sufficient Weight to press the Plough towards the Left, and keep it in its Work: The deeper you plow, the greater Weight is required to press it; so that the deeper your Land is, the worse (or into the larger Furrows) must it be broken up with one Coulter, insomuch that, if the Land be strong (as most deep Ground in *England* is), it is a Work of some Years to conquer it, after it has been rested. And often it happens, that the excessive Charge of this Tillage reduces the Profit of rich Land below that of poor.

This gives an Opportunity to deceitful Servants, of imposing upon their ignorant Masters. They plow such deep Land with a small shallow Furrow, to the end the Turf and Furrows may be broken, and made fine the sooner; pretending they will plow it deeper the next time (which is called Stirring), which these Rogues know very well cannot be done, and intend no more than that the Plough coming the easier after the Horses, their Coats may shine the better; and tho' there be no Crop at Harvest, they must have Four Meals a Day all the Year, and extravagant Wages at *Michaelmas*, or at any time of the Year, when they think fit to misbehave themselves.

This

This sort of Land must not be stirred, *i. e.* plowed the Second time in wet Weather; for that will cause the Grass and Weeds to multiply, besides the treading the Ground into hard Dabs, &c. And, in dry Weather, the Plough will never enter any deeper than it went the first time; the Resistance below being so much more than the Pressure above, the Plough will rise up continually; or, if it goes deep enough for the Weight of Earth to keep it down, another Inconvenience will follow, which is that mentioned by *Columella*, Page 47. *Quod omnis humus, quamvis lætissima, tamen inferiorem partem jejuniorem habet, eamque attrahunt excitatæ majores glebæ; quo evenit, ut infæcundior materia mista pinguiori segetem minus uberem reddat.* The vulgar *English* Phrase is, It spaults up from below the Staple. Hence the treacherous Plowman is secure of an easy Summer's Work, if he can persuade his Master to suffer him to fallow the Ground with a shallow Furrow.

Another way to conquer a strong Turf is, to plow it first with a Breast-plough, very thin; and, when the Swerd is rotten, then plow it at the proper Depth: But this Method is (besides the extraordinary Charge of it) liable to other great Misfortunes. If the Turf be pared up in Winter, or early in the Spring, it is a Chance but the Rains cause it to grow stronger than before, instead of its Rotting.

And if it be pared later, tho' dry Weather do follow, and continue long enough to kill the Turf, yet this loses time; the Season of plowing is retarded; for all the Staple still remains untilled; and, before that can be well done, the Year is too far spent for sowing it with Wheat, which is the most proper Grain for such strong Land (*a*); and few will have Patience to wait, and plow on till another Wheat-seed

(*a*) Besides, most strong Land has Stones in it, which will not admit the Use of the Breast-plough.

time. The dry Weather also, which in Summer kills the Sward, renders the Plowing obnoxious to most or all the Evils afore-mentioned.

A Farmer inquires concerning the Four-coulter Plough, as in the following DIALOGUE.

Farm. *What must we do then? Must we have recourse to the Spade for breaking up our rich, strong, swardy Land?*

Resp. If you can procure Men to dig it faithfully in Pieces, not above Two Inches and an half thick, at the Price of about Eight Shillings *per* Acre, it would do very well, and answer all the Ends of Tillage; but, tho' you bargain with them to dig it at that Size for Three Pounds *per* Acre, you will find, upon Examination, most of the Pieces or Spits, which are dug out of your Sight, to be of twice that Thickness. And no great Quantities can be this way managed, altho' the Price of Corn should answer such an extravagant Expence.

Farm. *Since it is so difficult to bring our strong Land into Tilth, after it has rested, that it cannot be speedily done by a Plough without a Coulter, or by one with a Coulter, in wet Weather or dry, nor with a Breast-plough, without a certain Expence, and an uncertain Success, the Spade is too chargeable a Tillage for the Field: It seems to me, upon the Whole, that we are Losers by this inaratae gratia terrae, unless we could contrive some other Method of reducing it sooner, and with less Charge, into Tilth; for I observe, that, when we sow it upon the Back, the Corn and Grass (or Couch), coming both together, exhaust the Ground so much, that by that time we can (which is about Three Years) reduce the great Lumps to a tolerable Fineness, it grows full of Grass and Weeds (which we call Foul), and loses that Fertility we expected it should acquire by Rest, be-*
coming,

coming, in our Terms, both out of Tiltb, and out of Heart.

Resp. If you know all this to be true, and that without a Coulter you cannot break it up at all; and that with one Coulter you cannot any way cut the Furrow small enough, or less than Ten Inches broad; why do not you cut it with Four Coulters, which will reduce the same Furrow into Four equal Parts, of Two Inches and an half each in Breadth, and of the Depth of the Staple, tho' that should be Two Spit, or Sixteen Inches deep?

Farm. *How can that be done?*

Resp. Every jot as easily as with one Coulter: For, before the Furrow is raised by the Share, it lies fast, and makes a sufficient Resistance equally against the Edges of all the Coulters; tho', after it be raised and loose, it yields and recedes every way, except downwards; so that it cannot be cut by any Edge, but such as attacks it perpendicularly from above, as that of the Spade does.

Farm. *This seems to me reasonable; and, having very lately heard talk of this Plough, I would gladly know more of it.*

Resp. The Furrow, being cut into Four Parts, has not only Four times the Superficies on the Eight Sides which it would have had on Two Sides; but it is also more divided cross-ways; *viz.* The Ground-wrest presses and breaks the lower (or Right-hand) Quarter; the other Three Quarters, in rising and coming over the Earth-board, must make a crooked Line about a Fourth longer than the strait one they made before moved; therefore their Thinness not being able to hold them together, they are broken into many more Pieces, for want of Tenacity to extend to a longer Line, contrary to a whole Furrow, whose great Breadth enables it to stretch and extend from a shorter to a longer Line, without breaking; and, as
it

it is turned off, the Parts are drawn together again by the Spring of the Turf or Swerd (*a*), and so remain whole after Plowing. Thus the Four-coultered Plow can divide the Soil into above Twenty times more Parts than the common Plough; and sometimes, when the Earth is of a right Temper betwixt wet and dry, the Earth-board, in turning the Furrows off, will break them into Dust, having more Superficies than is made by Four common Plowings; and it is impossible there should be any large Pieces amongst it.

Now, what a prodigious Advantage must the Influences of the Atmosphere have upon these small Parts, for making a further Division of them! Frost, Water, Drought, and nitrous Air, easily penetrate to their very Centers, which cannot in the largest of them be more than one Inch and a Quarter distant from their Superficies. This Advantage, with a few subsequent common Plowings, performed in proper Seasons, resolves the Earth almost all to a Powder. The Swerd, some being immersed or buried and mixed among so great a Proportion of Mould, is soon rotten and lost; some of the Swerd lying loose a-top, the Earth presently drops out of it; and then the Roots are dried up, and die. Thus is the whole Staple of the Ground brought into perfect Tilth in

(*a*) A swerdy Furrow cut off by only one Coulter, being whole, is apt to stand up on its Edge, or lie hollow; and then, being open to the Air, it does not rot; but when it is cut by several Coulters, it has not Strength to support itself, it falls down, lies close to the Earth under it, and, excluding the free Air from the Turf, it soon becomes rotten. And for killing the Turf of swerdy Land is the chief Use of the Four-coultered Plough: For doing of which there is this Advantage, that as in a whole Furrow there are often Strings of Couch-grass, Three or Four Feet long; but, when cut by this Plough, there is scarce a String left of one Foot long: And these Strings being apt to send out Roots from every Knot or Joint, the shorter they are cut, the more they will be exposed to the Air and Sun, which will kill them the sooner.

a very short time beyond what the Spade ever does in such swerdy Land.

Farm. What sort of Weather is best for using this Plough?

Resp. Any Weather, except the Ground be so dry and hard that the Plough cannot enter it; but it is very proper to be done, when the Earth is so wet, that by no means it ought to be plowed with any other Plough; for it never can be too moist for this, unless the Cattle which draw it be mired; because, tho' all the Cattle should not go in the Furrow, yet their Treadings are cut so small by the Coulters, that the Earth is not kept from dissolving, as when turned off whole in common Tillage. 'Tis observed, that the Incisions made by the Coulters on swerdy Land, will not heal, or so close up, but that they will open again by the next Plowing, though it be a great while after. A Farmer who uses this Plough, may till in all Weathers and all Seasons of the Year, either in fallowing with this, which is best in wet, or in stirring with the common ones, which must be done in dry Weather; and when the Ground is broken up with this, it may be stirred in the driest Weather that can be, without the Danger of tearing (or spaulting) up of the under *Stratum* along with the Staple, because this is all broken before, and then no more can rise with it; as it does to the Ruin of the Soil, when in common Tillage they go deeper the Second time than the First: Also, if there be a Necessity of stirring some sort of Land when it is wet, it ought either to be done with this Plough, or else with a common one drawn by a single Row of Cattle treading all in the Furrow; for tho' some Land be very fine, yet, when plowed by a double Row of Cattle in wet Weather, it will be made into large Pieces by the Treading, and perhaps not dissolve again in a long time: Therefore it is better to be prevented.

Farm.

Farm. *I perceive this Plough lays the Foundation for all good Husbandry; and there can be no other way to bring Land into perfect Tiltb in so short a Time, or with so little Expençe. And I am convinc'd, that no Farmer ought to be without it, who desires to be free from the Danger of his Land being ever out of Tiltb: But I have heard it objected, that it is harder to draw than the common Picughs; and that its Beam being longer, upon account of the Four Coulters, it lies farther behind, and comes harder after the Horses.*

Resp. I must confess, there is something in that Objection; for this Plough, being something longer, may be a little the harder Draught; and also its Weight and Strength must bear a Proportion to the Length of it. But this small Increase of the Draught would have been a much stronger (if not a fatal) Objection, had that Custom been general, of Horses drawing by their Tails, as 'tis said to have been formerly in some Places; for then, perhaps, a sufficient Strength of Horses could not be applied to the Plough. But in Countries where Traces are in Use, every Horse of the Team may draw the Plough equally, and then there will be no other Inconvenience, besides the adding one Horse, or keeping a stronger Team: And he cannot be wise, who would lose the Profit of his Land, for the Odds of sometimes adding a Horse to his Plough. And I am very certain, that this Plough requires a much less Strength of Cattle to draw it in moist Weather, which is the most proper to use it in, than to draw a common Plough in the same Ground, and at the same Depth, in dry Weather; and can seldom be used safely in any other. And the Vulgar, who have always a wrong Cause ready at hand to apply to every thing, impute that Draught to the Fashion of the Plough, which ought to be imputed to its going deeper; and this great Depth at which 'tis capable of plowing, viz. Two

Spit deep, is one extraordinary Benefit of it, tho' it may, on Occasion, go as shallow as any.

The Draught is not so much increased by adding Three Coulters, as may be imagined; for when the Ground is moist, the Incisions are easily made by the Edges; and when they are cut small, the Furrows rise much more easily upon the Share and Earth-Board, than if whole.

Farm. *If this Plough be so beneficial, having so many Advantages, and only the Two Inconveniencies, one of requiring a little more Strength to draw it, and the other its being unfit for dry hard Ground, I wonder why it is not become more common?*

Resp. It has been used with very great Success for these several Years last past, but never like to be common, unless it be described in a more geometrical Manner, than any Plough has hitherto been; for the Plough-wrights find it difficult enough to make a common Plough with one Coulters to perform as it ought, for want of the necessary Rules of their Art. It is upon this Account that the Two-coulter'd Ploughs are used in few Places, though they have been found of excellent Use, and have been formerly common: But, alas! when the Makers, who by their diligent Study and much Practice had attained the Perfection of their Art, died for want of learning to write their Rules mathematically, and shew how the mechanical Powers were applicable to them, the Art was in a Manner lost, at the Death of those Artists; and then the unskilful Plough-wrights, destitute of the true Rules, were not able to make a Two-coulter'd Plough to perform well, and then it was left off. Very lately 'tis revived, since the Three and Four-coulter'd ones have been used; from whence some have made a Shift to take the Rules of placing Two Coulters into a Plough, and they begin to be common again; and, no doubt, will cease again as soon as the Rules are forgot.

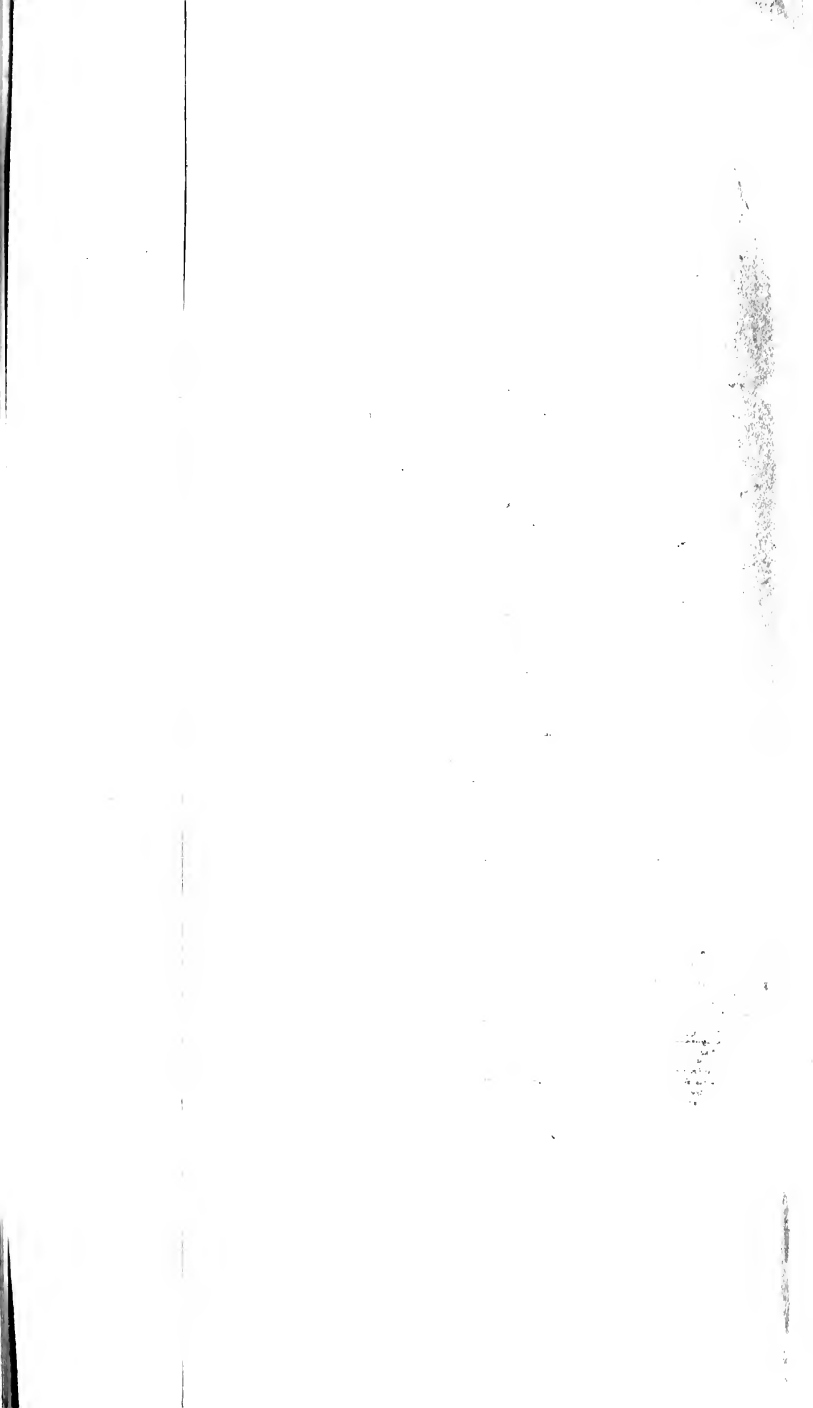

'Tis strange that no Author should have written fully of the Fabric of Ploughs! Men of the greatest Learning have spent their Time in contriving Instruments to measure the immense Distance of the Stars, and in finding out the Dimensions, and even Weight, of the Planets: They think it more eligible to study the Art of plowing the Sea with Ships, than of tilling the Land with Ploughs; they bestow the utmost of their Skill, learnedly, to pervert the natural Use of all the Elements for Destruction of their own Species, by the bloody Art of War. Some waste their whole Lives in studying how to arm Death with new Engines of Horror, and inventing an infinite Variety of Slaughter; but think it beneath Men of Learning (who only are capable of doing it) to employ their learned Labours in the Invention of new (or even improving the old) Instruments for increasing of Bread.

The easiest Method of perpetuating the Use of the many coulter'd Ploughs, and other newly-invented Instruments of Husbandry, is by Models, *i. e.* the Things themselves in little; and these may be all portable even in a Man's Pocket: Every Part must be fully described, with the true Dimensions, and the mathematical Reasons, on which their Contrivance is founded. Directions also for using them must be given at the same time that their Manner of making is described. In some, the very Horses which draw must be represented, to shew the manner of fixing the Horses, and the Traces: Cautions against all the Errors that may happen by the want of Experience in the Makers or Users, must be given.

When this is done, and the Rules put into a Method, the new Hoeing-Husbandry, in all its Branches, will be much more easy and certain than the old; because there are no mathematical Rules extant in any Method; and a Man may practise the old random Husbandry all his Life, without attaining so much Certainty in Agriculture as may be learned in a few Hours from such a Treatise.

The Rules, indeed, require much Labour, Study, and Experience, to compose them; but when finish'd, will be most easy to practise: Like the Rules for measuring Timber; their Use is, at first Sight, easy to every Carpenter, and to most Artificers who work in Wood; but no illiterate Person is able to compose those Rules, or to measure Timber without them.

C H A P. XIX.

The Description of a Four-coulter'd Plough.

TO describe all Parts of a Plough geometrically, would require more Time and Learning than I am Master of: Therefore leaving that to be done by somebody else, who is better qualified for it, I shall at present attempt little more than what relates to the Three added Coulters.

In *Plate 1. Fig. 1.* is the Portrait of a common Two-wheel'd Plough used in *Berkshire, Hampshire, Oxfordshire, and Wiltshire*, and in most other Countries of *South-Britain*; and is generally esteemed the best Plough for all Sorts of Land, except such miry Clays that stick to the Wheels, and clog them up, so as they cannot turn round.

But they have, in some Places, a Contrivance to prevent this Inconvenience; which is done by winding Thumb-ropes of Straw about the Iron Circles of the Wheels, and about the Spokes. The Wheels pressing against the Ground, the Thumb-ropes are distended on each Side: which Motion throws off the Dirt, and prevents its sticking to the Wheels, which it would otherwise do.

'Tis commonly divided into Two Parts; *viz.* the Plough-head; and the Plough-tail.

The Plough-head contains the Two Wheels A, B, and their Axis or Spindle of Iron passing thro' the

Box

Box C, turning round both therein, and in the Wheels; the Two Crow-staves D, D, fastened into the Box perpendicularly, and having in each Two Rows of Holes, whereby to raise or sink the Beam, by pinning up or down the Pillow E, to increase or diminish the Depth of the Furrow; the Gallows F, thro' which the Crow-staves pass at top, by Mortises, into which they are pinned; G the Wilds with its Links and Crooks of Iron, whereby the whole Plough is drawn; H the Two-chain, which fastens the Plough-tail to the Plough-head, by the Collar I at one End, and by the other End passing thro' a Hole in the Middle of the Box, is pinned in by the Stake K; L the Bridle-chain, one End whereof is fastened to the Beam by a Pin, and the other End to the Top of the Stake, which Stake is held up to the left Crow-staff, by the With M, passing round it above, and under the End of the Gallows below; or instead of this With, by a Piece of Cord, and sometimes by the End of the Bridle-chain, when that is long enough.

The Plough-tail consists of the Beam N: the Coulter O; the Share P; and the Sheat Q; the Hinder-sheat R, passing thro' the Beam near its End; S the short Handle, fastened to the Top of the Hinder-sheat by a Pin, and to the Top of the Sheat by another Pin; T the Drock which belongs to the right Side of the Plough-tail, and whereto the Ground-wrist V is fasten'd; as is the Earth-board, whose Fore-part W is seen before the Sheat; and also the long Handle X, whose Fore-part Y appears before the Sheat, and is fasten'd to the Drock by a Pin at *a*, the other End of which Pin goes into the Beam. Z is the double Retch, which holds up the Sheat, and passes through the Beam to be fasten'd by its Screws and Nuts at *b* and *c*.

But without intrenching much farther upon the common Plough-wright's Art, whose Trade is his Living, I'll hasten to shew the necessary Difference

there is betwixt the common Plough, and the Four-coulter Plough, beginning with *Fig. 2.* where it is represented as standing upon a level Surface.

Fig. 2. And, First, The Beam differs in Length, being Ten Feet Four Inches long, as the other Plough-beam is but Eight Feet; it differs in Shape, as the other is strait from one End to the other, but this is strait only from *a* to *b*, and thence turns up of a sudden, in the manner that is shewn in the Cut; so that a Line let down perpendicular, from the Corner at *a*, to the even Surface whereon the Plough stands, would be Eleven Inches and an half, which is its Height in that Place; and, if another Line were let down, from the turning of the Beam at *b*, to the same Surface, it would be One Foot Eight Inches and an half, which is the Height that the Beam stands from the Ground, at that Part; and a Third Line let down to the Surface, from the Bottom of the Beam, at that Part which bears upon the Pillow, will shew the Beam to be Two Feet Ten Inches high above the Surface in that Part.

From the End *a*, to the Back-part of the first Coulter, is Three Feet Two Inches; from thence, to the Back of the next Coulter, is Thirteen Inches; thence to the Third, Thirteen Inches; and from thence to the Fourth, the same. From *a* to *b* is Seven Feet.

This Crookedness of the Beam is to avoid the too great Length of the foremost Coulters, which would be necessary if the Beam was strait; and then, unless they were vastly thick and heavy, they would be apt to bend, and the Point of the Fourth would be at so great a Distance from its Coulter-hole, that it would have the greater Power to loosen the Wedges, whereby the Coulter would rise up out of its Work, as it never doth when the Beam is made in this bending Manner. This Beam is made either of Ash, which is the lightest, or of Oak, which is the most durable.

durable. Its Depth and Breadth may vary, according to the heavier or lighter Soil it is to till; but this before us is in Depth Five Inches at the first Coulter-hole, and in Breadth Four Inches.

Fig. 4. Is the Sheat *Q* in *Fig. 1.* (broad Seven Inches) with the Iron Retch on it, the left Leg of which Retch must stand foremost, to the end that the Edge of its Fore-part, that is flat, may fit close to the Wood of the Sheat: This Retch holds the Sheat fast up to the Beam by its Nuts and Screws; as also doth a Pin driven into the Hole *a*, which Hole being a small Part of it within the Beam, the Pin being driven into the Hole, draws up the Sheat very tight to the Beam. The principal thing to be taken notice of here, is the Angle *b c d*, which shews the Elevation of the Sheat; the Line *c d* is supposed to be equal with the Bottom of the Share (or rather with the plain Surface whereon it stands); when this Angle at *c* is larger than of Forty-five Degrees, a common Plough never goes well: In my Four-coulter Plough I choose to have it of Forty-two or Forty-three at the most.

Fig. 5. Is the Share; *a* is the End of the Point; *b* is the Tail of the Share, long from *a* to *b* Three Feet Nine Inches; *c* the Fin; *d* the Socket, into which the Bottom of the Sheat enters; *e* a thin Plate of Iron riveted to the Tail of the Share: By this Plate, the Tail of the Share is held to the hinder Sheat, as at *d* in *Fig. 1.* by a small Iron Pin with a Screw at its End, and a Nut screw'd on it on the inner or right Side of that Sheat. From *a* to *f* is the Point, long about Three Inches and an half, flat underneath, and round at Top: It should be of hard Steel underneath. From *f* to *c* is the Edge of the Fin, which should be well steeled; the Length of it is uncertain, but it should never make a less Angle at *f* than it appears to make in this *Fig.* The Socket is a Mortise of about a Foot long, at the upper Part,

Two Inches deep: The Fore-end of this Mortife must not be perpendicular, but oblique, conformable to the Fore-part of the Sheat which enters it; the upper Edge of which Fore-part must always bear against the Sheat at *e* in *Fig. 4.* but if this End of the Socket should not be quite so oblique as the Sheat, it may be help'd, by taking off a little of the Wood at the Point *c.*

Fig. 6. Shews the Share, with its right Side upwards, in the same Posture as when it plows; whose Side *a b* should be perfectly strait, but its under Side at *c*, which is its Neck, should be a little hollow from the Ground, but never more than half an Inch in any Plough, and a Quarter of an Inch in a Four-coulter Plough; so that the Share, when it is first made, standing upon its Bottom, bears upon the level Surface only in Three Places; *viz.* at the very Point *a*, at the Tail *b*, and at the Corner of the Fin *d.*

Fig. 7. Is the Share, turn'd Bottom upwards; and shews the Concavity of the Fin at *a*; which must be greatest in a stony rubbly Soil.

Fig. 8. Shews the Share, the right Side upwards, but leaning towards the Left.

In placing of the Share rightly upon the Sheat, consists the well going of a Plough, and is the most difficult Part of a Plough-wright's Trade, and is very difficult to be shewn. Supposing the Axis of the strait Beam, and the left Side of the Share, to be both horizontal, they must never be parallel to each other; for if they were, the Tail of the Share, bearing against the Side of the Trench, as much as the Point, would cause the Point to incline to the right Hand, and go out of the Ground into the Furrow. If the Point of the Share should be set, so that its Side should make an Angle on the right Side of the Axis of the Beam, this Inconvenience would be much greater; and if its Point should incline much to the

Left, and make too large an Angle on that Side with the Axis of the Beam, the Plough would run quite to the left Hand; and if the Holder, to prevent its running out of the Ground, turns the upper Part of his Plough towards the left Hand, the Fin of the Share will rise up, and cut the Furrow diagonally (*a*), leaving it half unplow'd; beside, the Plough will rise up at the Tail, and go all upon the Point of the Share: To avoid these Inconveniencies, the strait Side of the Share must make an Angle on the left Side of the Beam, but so very acute, that the Tail of the Share may only press less against the Side of the Trench than the Point does. This Angle is shewn by the prick'd Lines at the Bottom of *Fig. 1.* where the prick'd Line *e f* is supposed to be

(*a*) This is the greatest Misfortune incident to a common Two-wheeled Plough, and happens generally by the Fault of the Maker, though sometimes by the Plowman's setting it so, that the Point of the Share turns too much to the Left. I have seen Land plowed in this manner, where not half of it has been moved, nor better tilled than by Raftering, not only cut diagonally, but also half the Surface hath remained whole, where when the Earth that was thrown on it was removed, the Weeds appeared unhurt on the unplowed Surface. In this Case, they for a Remedy set the Plough to go deeper; and then, if it go deep enough for the Fin to cut off the Furrow at a just Depth, the Point will go below the Staple, which may ruin the Soil, unless it be very deep

When our *English* Ploughs go in this manner, they make much worse Work than the *Eastern* Ploughs, that have no Coulter; for these, contrary to ours, though they always cut their Furrow diagonally, cut it thin on that Side from which it is turned, as our bad Ploughs leave it thin on that Side towards which it is turned. The Earth the *Easterns* leave by their Diagonal in one Furrow, is taken off by the next; but ours leaving Part of their Furrow behind them, on the Side next to the plowed Part of the Field, come at it no more; but the other can plow cleaner, their Diagonal being contrary to ours, which leaves the Trench deepest on the Side next to the unplowed Part of the Field; but unless the Fin of the Four-coulter'd Plough go parallel to the Surface of the Earth, it will not plough at all; or will leave Two or Three of its Four Furrows untouched.

the Axis of the Beam let down to the Surface, and the prick'd Line $g f$ parallel to the left Side of the Share; but this Angle will vary as those Two prick'd Lines are produc'd forwards to the Fore-end of a long and a short Beam, keeping the same Subtense: For Plough-wrights always take this Subtense at the Fore-end of a Beam, whether it be a long Beam or short one; and it is the Subtense $e g$, that determines the Inclination the Point of the Share must have toward the left Hand. Plough-wrights differ much in this Matter; but, by what I can learn by those that make the Ploughs I see perform the best, this Subtense at the Fore-end of an Eight-foot Beam should never be more than one Inch and an half; and by full Experience I find, that whether the Beam be long or short, the Subtense must be the same; for when my Plough-wrights take this Subtense at Eight Feet from the Tail, when they make my Four-coulter Plough, whose Beam is Ten Feet Four Inches long, the Point of the Share will incline too much to the Left, and it will not go well until this Fault be mended, by taking the same Subtense quite at the End of the Beam; which makes the mentioned Angle more acute.

Fig. 3. Shews the right-hand Side, and upper Side of the Four-coulter Plough, of which V the Iron Ground-wrist is shewn in *Fig. 9.* long Two Feet Five Inches, deep at the End b Four Inches, and Three-eighths of an Inch thick, except at the End a , where it is thin enough to bend, so as to fit close to the Share, as at e , in *Fig. 6.* The Ground-wrist has Four small Holes near its End a , into one of which goes a Nail, to fasten it to the Sheat, thro' the long Hole in the Side of the Socket of the Share, as at a , in *Fig. 10.* and then it will stand in the Posture shewn by $e f$, in *Fig. 6.* From the Outside of the Ground-wrist at f , to the Outside of the Share at b , is Eleven Inches and an half, which is the Width of the

the lower Part of the Plough-tail at the Ground; the Ground-wrist has several Holes at the upper Side of its broadest End, as at *b*, in *Fig. 9.* by which it is nailed to the lower Part of the Drock T, as in *Fig. 3.* which Drock with its Perforations is shewn in *Fig. 11.*

Fig. 12. Is the Earth-board, with its Inside upwards; the Notch *ab* shews the Rising of the Wood, which takes hold of the Edge of the Sheat, to hold it the firmer, to which it is fastened by the Holes *c* and *d*; and at the other End it is fastened to the Drock, at the Hole *e*. All which is seen as it stands mark'd with W, in *Fig. 3.* But this Pin, with which it is fastened to the Drock, is bigger in the Middle than at each End; which prevents the Earth-board from coming near the Drock: By this Pin, the Earth-board is set at a greater or less Distance from the Drock, as there is Occasion to throw off the Furrow farther from the Plough at some times than at others: It always stands considerably farther out on the right Hand than the Ground-wrist does, which is one Reason that the Drock is made crooked, bending outwards in that Part.

The long Handle X is *Fig. 13.* long Five Feet Four Inches, broad in the widest Part Four Inches, pinned to the Sheat thro' the Holes *a b*, and pinned to the Drock through the Hole *c*.

The short Handle S is *Fig. 14.* and is long Three Feet Nine Inches, pinned to the hinder Sheat (being *Fig. 15.*) by the Hole *a*, and to the Top of the Fore-sheat above the Beam by the Hole *b*.

The Handles are made so long, for the more easy guiding of the Plough; but the lazy Ploughman is apt to cut them off shorter, close up to the Plough, to the end that, bearing his whole Weight thereon, he may in a manner ride instead of walking; but if he should thus ride on long Handles, he would tilt up the Fore-end of the Beam, and raise the Share out of the Ground.

The

The chief, and most indispensably necessary thing to be observed, is, to place the Four Coulters in such a manner, that the Four imaginary Planes described by the Edges of the Four Coulters, as the Plough moves forwards, be all of them parallel to each other, or very nearly so; for if any one of them should be much inclined to, or recede from, either of the other three, they could not enter the Ground together. In order to place them thus, the Coulters-holes must be made through the Beam, in the manner as they are shewn in *Fig. 3.* viz. the Second Coulters-hole is Two Inches and an half more on the Right than the First, the Third, Two and an half more on the right Hand than the Second, and the Fourth, Two Inches and an half more on the right Hand than the Third, conformable to the Four Incisions or Cuts they are to make in a Ten-inch Furrow: And because no single Beam is broad enough to hold the Four Coulters-holes at this Distance, we are forced to add the Piece shewn in *Fig. 16.* The Second Hole is made Part in the Beam, and Part in this Piece; the Third and Fourth are made wholly in this Piece, in which *a, b, c,* are the Ends of the Three Screws, which fasten the Piece to the right Side of the Beam by their Nuts.

The Distance of Two Inches and an half, by which each of the Three added Coulters stand more to the right Hand than that immediately behind it, must be reckoned from the Middle of one Hole to the Middle of the other.

The Fore-part of every Hole must incline a little towards the Left; so that the Backs of the Coulters may not bear against the left Side of the Incisions made by the Edges.

Each Hole, being a Mortise, is one Inch and a quarter wide, with its Two opposite Sides parallel from Top to Bottom; each of these Mortises, or Holes, are long at Top Three Inches and an half, and at Bottom Three Inches; the Back-part, or Hinder-
end,

end, of each Coulter-hole is not perpendicular, but oblique, and determines the Obliquity of the Standing of the Coulter, which is wedged tight up to it by the Poll-wedge *i*, *Fig. 1.* as all Coulters are.

Fig. 17. Is a Coulter; *a b* is its Length, being Two Feet Eight Inches, before it is worn; *e d* is its Edge, Sixteen Inches long; *d c* is the Length of its Handle, Sixteen Inches; this is made thus long, at first, to stand above the Plough, that it may be driven down lower, according as the Point wears shorter; this Handle is One Inch and Seven Eighths broad, and Seven Eighths of an Inch thick, equally thro' its whole Length: Its Breadth and Thickness might be described by a rectangled Parallelogram.

In all Ploughs this first Coulter is, or ought to be, placed in the Beam in manner following; *viz.* its Back to bear against the Back of the Coulter-hole, its right Side above to bear against the upper Edge of the Coulter-hole, and its left Side to bear against the lower Edge of the Coulter-hole; so that always Three Wedges at least will be necessary to hold the Coulter; the Poll-wedge before it, as at *i*, in *Fig. 1.* another Wedge on the left Side of it above, and a Third on the right Side underneath: The Coulter-hole must be so made, that the Coulter standing thus across the Hole, its Point may incline so much towards the Left, as to be about Two Inches and an half farther to the Left (*a*) than the Point of the Share, if it were driven down as low as it; but it never ought to be so low in any Plough: As to its bearing forwards, the Point of the Coulter should never be before the Middle of the Point of the Share: What Angle the Coulter would make with the Bottom of the Share, may be seen by the Posture it stands in, in *Fig. 1.* If it should be set much more obliquely, it would have a

(*a*) I find that sometimes it is necessary in some of these Ploughs for the Point of this Coulter to stand yet farther on the Left of the Share's Point,

greater

greater Force to raise up the Poll-wedge, and get loose.

The Three added Coulters should stand in the same Posture with this already described, in regard to the Inclination of their Points towards the Left: And this is a very great Advantage to them; for by this means, when the Fin is rais'd up, by turning the Handles towards the Left, their Points do not rise out of the Ground on the right Hand, as they would do without this described Inclination towards the Left; but in regard to their Pointing forwards, I find it best, that every one of the Three should be a little more perpendicular than that next behind it. So the Coulter 4 stands the nearest to Perpendicular of any of them. By this means there being more Room betwixt them above than below, they are the more easily freed from the Turf, whenever the Pieces, being covered with a great Quantity of Couch-grass, or the like, rise up betwixt them: which tho' this seldom happens, makes a Necessity for a Man, or a Boy, to go on the Side with a forked Stick, to push out the Turf and Grass, which might otherwise fill the Spaces betwixt the Coulters, and raise up the Plough out of its Work.

'Tis to be observed, that none of these Coulters ought to descend so low as the Bottom of the Share, except when you plow very shallow: 'Tis always sufficient that they cut through the Turf, let the Plough go never so deep in the Ground.

It is necessary also, that when you plow very shallow, the Fin of the Share be broad enough to cut off the Fourth Piece or Furrow; else that, lying fast, will be apt to raise up the Ground-wrist, and throw out the Plough: But when you plow deep, the Ground-wrist will break off this Fourth Furrow, altho' the Fin be not broad enough to reach it.

Sometimes the First or left Furrow is apt to come through betwixt the First Coulter and the Sheat, and

So falls on the left-hand Side of the Plough : This is no Injury ; but yet it is prevented, by letting the Second Coulter stand a lighter higher than the Third ; and then the Second Furrow, holding the First at its Bottom, will carry it over, together with itself, on the right Side by the Earth-board ; but yet never set this, or any of the Three added Coulters, so high that they may not cut through the Turf. But as for the first Coulter, tho' it should cut but an Inch or Two within the Ground, the Share will break off the first Furrow in raising it up.

Remember, as often as the Point of any Coulter is worn too short, that you drive down the Coulter with a large Hammer, carried for that Purpose ; and when it is driven low enough, fasten the Wedges again, so as to keep the Coulters in their right Postures, that their Incisions may be all of them equidistant.

Fig. 18. Is a Nut, with Two of its opposite Corners turn'd up, by which it is driven round by a Hammer, and has so great a Force, that Three of them, with their Screws properly placed, hold the Piece, *Fig. 16.* as fast to the Plough-beam, as if they both were made of one Piece of Wood ; but as often as the Wood shrinks in dry Weather, the Nuts must be screw'd farther on, both here and in all other Places where they are used : particularly, those which hold up the Retch ; for if the Sheat should once get loose, there is no Cure but by a new one.

Betwixt this Nut and the Wood, there should be a thin Iron Bolster, about the Thickness of a Shilling, broader than the Nut, to prevent the Nut from eating into the Wood, especially when it is to be often screw'd, as on the Retch of these Ploughs, and most of all on the Hoe-plough ; but sometimes we use a Piece of Shoe-leather instead of an Iron Bolster.

Note, There must be Iron Plates upon all the Coulter-holes both above and below, Three of which
are

are seen on the Piece in *Fig. 16.* There is no need to say how they must be nailed on with many Nails made for the Purpose.

Fig. 19. Is the Iron Collar, fastened to the Beam by Two short Crooks A, B, which take hold of Two short Pins driven into the Plough just behind the Second Coulter-hole, one on one Side, and the other on the other Side of the Beam. The Crook A is seen on the left Side of the Beam near *c*, in *Fig. 2.* the Crook B doing the same on the other Side of the Beam, which is seen near *a*, in *Fig. 3.* C is the Crook (for its Shape called a C) which holds the Tow-chain to the Collar by the Link D, being Part of the said Chain taking hold of its Fore-claw; the other Claw taking hold of one of the Five Notches of the Collar: This Collar is partly seen at *d*, in *Fig. 2.* Both the Claws of the Crook (or C) turn upwards, so that they cannot take hold of any thing that may rise under the Plough: The Use of the Notches is to help the Direction of the Point of the Share, which has been described by the prick'd Lines under *Fig. 1.* As the Point of the Share wears, it inclines a little more towards the Right, and is remedied by moving the Crook into a Notch nearer to the Left, which will direct the Point a little more towards the Left: This is more easy to be done here than in the common Plough, whose Collar moves round the Beam: We can, by changing the Crook from one Notch to another, incline the Point of the Share towards the Right or Left at Pleasure. The Length of each Side of this Collar is a Foot long.

The Tow-chain is best seen in *Fig. 3.* where the Link Y is that which passes thro' the Box, and is pinned in by the Stake, as has been shewn in *Fig. 1.* which Stake is commonly nailed to the Box, to prevent its rising up. When we would draw up the Plough a little nearer to the Crow-staves, we take hold of the Crook by a Second or Third Link.

Note,

Note, That the shortening of the Chain does also a little incline the Point of the Share towards the Left.

Fig. 20. is the Iron-wilds. The Leg A is of one Piece with that which has the Notch, and that passes thro' the Leg B by the Loop at *a*; both which Legs pass thro' the Box, and are pinned in behind it, by the crooked Pins C, D. This Figure is seen with its Crooks on it, both in *Fig. 1.* and *Fig. 2.* *Note,* That the Holes in the Box, thro' which these Legs pass, must not be made at right Angles with the Box, but must incline upwards, so that the Fore-part of the Wilds may be higher than the Hinder-part, or else the Upper-part of the Crow-staves would lean quite back when the Plough is drawn. If the Beasts that draw immediately next to the Plough be very high, their Traces must be the longer; else they and the Wilds making too small an Angle with the Tow-chain at the Box, when they draw hard, the Wheels will rise from the Ground, and be apt to overturn: This Angle I suppose should not be less than of 160 Degrees, and the Angle made by the Tow-chain or Traces that are drawn by the Cattle that go before them, will make an Angle with the Tow-chain at the Box yet much more obtuse. The Use of these Notches in the Wilds is, to give the Plough a broader or narrower Furrow: If the Links are moved to the Notches on the right Hand, it brings the Wheels towards the left Hand, which gives a greater Furrow; and when the Links are moved towards the left Hand, it gives a less Furrow, by bringing the Wheels towards the right Hand.

The Distance betwixt the Two Legs of the Wilds is Eight Inches and an half; the Length of the Legs is Nineteen Inches. They must be of convenient Strength. The Links being placed in Notches distant from one another, prevents one Wheel from advancing before the other; which would happen, if the Links were both in One Notch, or in Two adjoining

Notches, except they were middle Notches: These Links are each Six Inches and an half long.

E is the Ring, by which the Two Links, and the Two Crooks F and G, are held together, and on which they all move.

The Height of the Wheels in *Fig. 2.* The left-hand Wheel is Twenty Inches Diameter; the Diameter of the right Wheel is Two Feet Three Inches; the Distance the Wheels are set from each other at the Ground, is Two Feet Five Inches and an half; the Crow-staves are One Foot Eleven Inches high, from the Box to the Gallows; they both stand perpendicular to the Box, and the Distance between the Crow-staves is Ten Inches and an half. The Pillow is pinned up at its Ends by Two small Iron Pins, which are chained to it, that if they drop, they may not be lost. These appear in *Fig. 1.* and *Fig. 2.* The Height from the level Surface, up to the Hole in the Box, where the Tow-chain passes through it, is Thirteen Inches (being Two Inches below the Holes of the Wilds, on the Hinder-side of the Box); the Height at the other End, where the Crook of the Collar takes hold of the Pin in the Beam at *c*, in *Fig. 2.* is Twenty Inches high above the same level Surface, and shews how much the Chain descends forward, for drawing down the Plough, and by which Descent may be known what Angle the Chain would make with the Surface, if it were produced forwards in a strait Line; which is a thing material for the good going of a Plough; and so is the Angle the Tow-chain makes with the Beam: About the Middle of this Tow-chain, there should be a Swivel, whereby one End of the Chain may turn without the other.

When this Four coulter Plough is made, I would advise, that it be tried with only the first Coulter, before the other Three are put in; for if the Plough does not go well with One Coulter, it is not likely it should go well with Four; and I never yet have seen

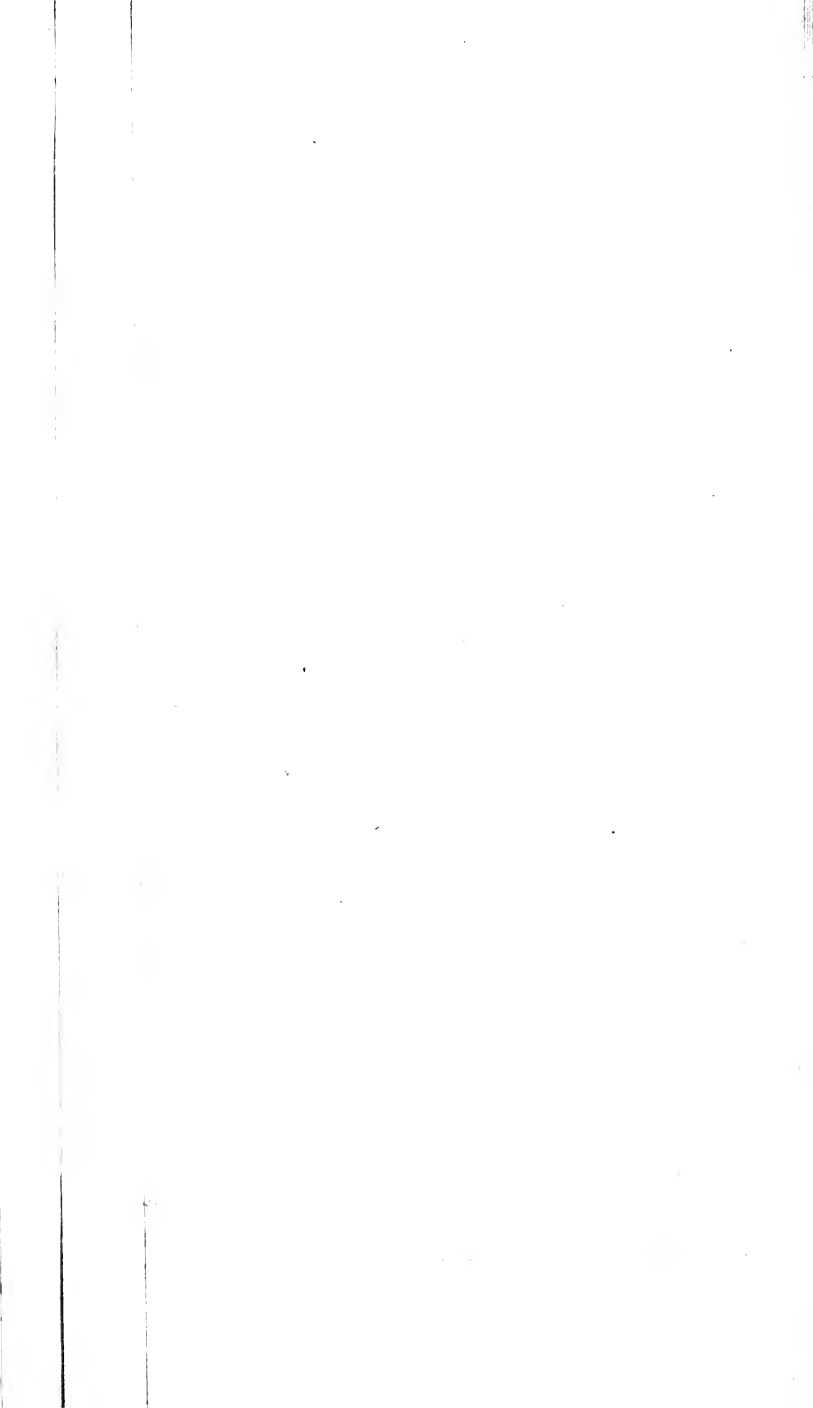

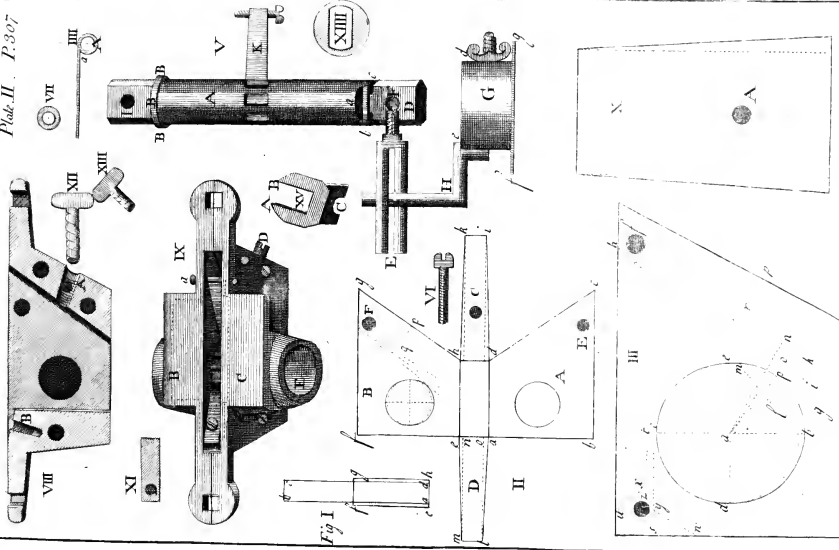

B. C. de D. de la c. de la

or heard of any that went well with One Coulter, that did not also go well with Four, being placed as is here directed.

The Proofs of a Plough's performing well are these; *viz.* If it makes a Furrow of an equal Depth on the right Hand and on the left; and turns it off fairly: If, in its going, the Tail of the Share, and the Bottom of the Drock, bear against the Bottom of the Furrow, and if it goes easy in the Hands of the Holder, without pressing one Arm more than the other; then the Plough is certainly a good one.

The Ploughman who is accusom'd to a Two-wheel'd Plough, never suffers the Wheels to overturn, in turning out at the Land's End, from one Furrow to another; for which Purpose, after he has lifted the Plough a little round, he has a Knack of holding up the Crow-staves with the End of the Beam, by pressing his Hand hard against the Handle, whilst the Plough lies down on one Side, until the Horses, the Wheels, and the Plough, come near to a Line in the Beginning of the Furrow; and then he lifts up his Plough, and goes on.

C H A P. XX.

Of the Drill-Boxes.

THE Drill is the Engine that plants our Corn and other Seeds in Rows: It makes the Channels, sows the Seed into them, and covers them at the same time, with great Exactness and Expedition.

The principal Parts of the Drill are, the Seed-box, the Hopper, and the Plough, with its Harrow.

Of these the Seed-box is the Chief: It measures (or rather numbers) out the Seed which it receives

from the Hopper: It is for this Purpose as an artificial Hand, which performs the Task of delivering out the Seed, more equally than can be done by a natural Hand.

It is described, together with some of its Appurtenances, in *Plates 2 and 3.*

The MORTISE.

As the Seed-box is the principal Part of a Drill, so is the Mortise the principal Part of the Seed-box.

The following Descriptions shew how this Mortise differs from a common Mortise.

Fig. 1. Plate 2. shews both the upper and lower Edges of a Turnep-Seed-box, and the Manner how they are posited one over another. $a b c d$ is a rectangled Parallelogram, and shews the upper Edges (or Top) of the Mortise. $e f g h$, being a Figure of the same Denomination with the former, is the lower Edges (or Bottom) of the Mortise. The Line $e b$ is the Length of the lower Edge of the Hinder-end of the Mortise. $a d$ is the upper Edge of the Hinder-end of the Mortise, and posited just over the lower Edge of the same End. The Space between the Line $a b$, and the Line $e f$, shews half the Excess whereby the Bottom of the Mortise exceeds the Top in Breadth; as the Space on the opposite Side, betwixt the Line $c d$, and the Line $g h$, shews the other Half of that Excess, both which Halves, taken together, shew the whole Bevel (or Angle of Inclination) described in *Fig. 2.* That Part of the Line $a b$, from the Angle at b to the Line $f g$, which intersects it, shews the Excess whereby the Top of the Mortise exceeds the Bottom in Length.

Fig. 2. Is the Mortise cut down by its Four Corners, and laid open. $a b c d$ is a Trapezium, with Two parallel Sides, and mark'd A, the right Side of the Mortise; its opposite Side $e f g h$, mark'd B, the

the left Side of the Mortise; the Areas of both being true Planes (*a*).

d i k b Shew the Fore-end of the Mortise, mark'd C. *a l m e* shew the Hinder-end of the Mortise, mark'd D. *a d b e* shew the Bottom of the Mortise already described in *Fig. 1.* If these opposite Sides and Ends were all raised up, until the Angle at *b* join the Angle at *l*, and that at *m* join *f*, and that at *g* join *k*, and that *i* join *c*, the Top of the Mortise would be formed, and the same with the Parallelogram *a b c d*, in *Fig. 1.* and then the intire Mortise of the Turnep Seed-box would appear in its true Form, standing upon its Bottom.

This differs from a common Mortise, in that it is impossible to fit it with a Tenon; because it is narrower above, and shorter below, as in *Fig. 1.*

The Areas, or imaginary Planes, of the Top and Bottom of the Mortise, are parallel to each other, but not equal.

Its Two opposite Sides are equal, but not parallel; by reason of their Inclination to each other upwards, which is the Bevel hereafter to be described.

The Two Ends are neither parallel nor equal, because the Hinder-end D is perpendicular to the Top and Bottom, and the Fore-end oblique, and therefore longer.

(*a*) Take care that these opposite Sides be sure to be true Planes, especially all that Part of their Areas, that is before the transverse Axes of their Ellipses herein after described; for should they be otherwise, the Bevel of the Mortise would be spoiled, and so would the Ellipses, and the acute Triangles, on the Sides of the Tongue; which how necessary they are to be true, is shewn in the proper Place. Workmen are very apt to fail in this when they file by Hand, and make these Sides of the Mortise convex instead of plane. Therefore this might be done with less Difficulty, and more Exactness, with a File placed in a Frame, whereby it might move upon a true Level without rising or sinking of either End.

When Two opposite Sides, or Surfaces, are inclined to each other upwards, I call that Inclination a Bevel; but when they are inclined downwards, I call it a Bevel revers'd.

The Line ae , being the Bottom, or Base, of the Hinder-end D, by being longer than the Line lm , shews that the Mortise is bevel.

The Two prick'd Lines mn and lo , with the Line lm , and Part of the Line ae , make a rectangled Parallelogram, which shews the exact Depth of the Mortise, and forms on each Side of it a rectangled Triangle, the one men , and the other loa ; which Triangles being similar and equal, and their acute Angles at l and m being each of Four Degrees, make the whole Bevel, or Inclination of the Sides of the Mortise, to be of Eight Degrees, their Hypothenufes being the same with the Sides of the Mortise.

This End D, being raised up to its Place, will be at right Angles with the Plane of the Top and of the Bottom of the Mortise; which, being both rectangled Parallelograms, prove that Bevel, or Angle of Inclination, to be the same from one End to the other of the Sides, which Sides are the Hypothenufes of those Two Triangles: But this could not be proved by the Triangles in the opposite End C; because the Bases being the same with the other, and having their Legs longer, the vertical Angles at k and i are more acute. The Legs are longer; because the End C, when in its Place, is not at right Angles with the Top and Bottom of the Mortise, as the End D is.

The next thing to be described in the Mortise, is the Bore, great Hole, or Perforation; which is best shewn in the Side of a Mortise of a Wheat-drill, being larger, as in *Fig. 3.* wherein $cebd$ is the great Hole, and is a Section of an hollow Cylinder, that passes through the Mortise, with its Axis parallel to the Edges of the Ends of the Mortise: This
Cylinder,

Cylinder, being cut by the Side of the Mortise obliquely, and not parallel to its Base, is an Ellipse.

The prick'd curve Line is a Circle parallel to the Base of the Cylinder, and the curve Line *b d c e* is the Ellipsis; and this Curve is more or less elliptical (or oval) in proportion to the Angle of Inclination, or Bevel, of the Sides of the Mortise.

Of this Ellipse the longest Diameter (or *Axis transversus*) *b c* is at right Angles with the upper and lower Edges of the Sides of the Mortise.

Its shortest Diameter (or *Axis rectus*) *d e*, is the Diameter of the Cylinder, bisecting the *Axis transversus* at right Angles in the Centre *a*; and is in this Figure one Inch and an half.

This Ellipse being concentric with the Circle, the Letter *a* is the Centre of both.

The Semi-ellipsis *c e b* is the Part of chief Use; and therefore the Edge must of Necessity be smooth, and without Flaws, as must the Surfaces of the Sides of the Mortise betwixt the Ellipse and the Fore-end.

The Tongue of the Seed-box (*Plate 3. Fig. 1.*) differs from that in the Sound-board of an Organ (from which I took the Idea of it) in Shape, in Situation, and in the Manner of its being fix'd to the Mortise.

The Tongue, in the Organ, is on its Surface a long Square, or rectangled Parallelogram, a little broader and longer than the Mortise (or Grove) it shuts against; but this Tongue on its upper Surface, which is here turned downwards, being a Plane, is a Trapezium, of the same Shape with the Fore-end of the Mortise just now described, except that the Tongue has a less Bevel.

The Situation of that in the Organ is on the Outside of the Mortise, which it shuts by its Spring behind it, and opens immediately by the Finger of the Organist pressing down the Key to let in the compressed Air to its Pipes; but this Tongue is situate

within the Mortise of the Seed-box, and placed almost, in a manner, diagonally; for, had it been placed like the other, the Seed getting betwixt it and the Edges of the Mortise, would not have given Way to its Shutting (as the Air does to the other), but have kept it always open; which would have render'd it useleſs for ſowing of Seeds.

The Manner of faſtening the Organ-tongue to its Mortiſe is by Parchment and Leather glu'd to its Surface, and alſo to the Sound-board, at its End which is oppoſite to that preſſed open by the Key, and ſhut by the Spring; but this our Tongue is held within the Mortiſe, and moves on an Axis, which paſſes thro' its upper and narrower End, which Axis is the Pin *A* (which muſt be exactly parallel to the Edge of the End of the Mortiſe), and alſo thro' the Hole *f* in *Fig. 3.* in *Plate 2.* which is ſeen in its Place at *A* in *Fig. 3.* *Plate 3.* and likewise through both Sides of the Mortiſe near their upper Edges, and as near the Fore-end of the Mortiſe as may be, without the Tongue's rubbing againſt the ſaid Fore-end.

The Breadth of the Tongue muſt be conformed to the Breadth and Bevel of the Mortiſe, and when it is on its Axis, it being raiſed tight up as far as the ſhort prick'd Line *lm* in *Fig. 3.* *Plate 2.* being One-eighth Part of the great Hole, and being there, you ſee its upper Edges touch both Sides of the Mortiſe by their whole Length: Then it is rightly made: and by this touching both Sides of the Mortiſe tightly and cloſely, when raiſed up to that Degree, it appears, that the Two upper Edges of the Sides of the Tongue are inclined to each other in an Angle that is more acute, by about One-third, than is the Angle of Inclination of the Sides of the Mortiſe.

Hence, when the Tongue is let down to its Place, there will be on each Side of it an empty Space, betwixt it and the Mortiſe, of the Form of a very acute

acute Triangle, whose vertical Angle is more or less acute, according as the Tongue approaches nearer to, or recedes farther from the Spindle.

This *Fig. 1. Plate 3.* is the brass Tongue with its Back-side upwards. The Two outer Lines *a b* and *c d* are the Edges of the upper Surface (tho' turned downwards in this Figure), which are inclined to each other, as afore-mentioned; but the Two inner Lines *e f* and *g b* are nearer to each other, whereby this under Surface is narrower than the upper: Both must be plain Surfaces, but the upper and its Two Edges very free from Flaws, and smooth, or polished.

The Reason why the under Surface is narrower than the upper, is to preserve the Bevel of the empty Triangle: For though the Bevel of the Sides of the Mortise would be sufficient for this, if both Sides of the Tongue were sure to keep equally distant from the Spindle; yet as the Tongue never is so tight on its Axis, but that sometimes one Corner of it may be nearer to the Spindle than the other, in this Case, that Side which is nearest to the Spindle would reverse that Bevel, so as to make the small empty Space that is betwixt the Mortise and the Tongue, wider above than underneath.

C C are the Two little Knobs that prevent the Spring from slipping to either Side, and are at the Distance from one another of the Breadth of the Spring.

Fig. 2. shews one Side, and the Thickness of the Tongue the other Side, being the same. *a b* shews the polished Surface (being a true Plane), whereon the Seed runs down to the Spindle. *c d* the Back-side, which lies turned uppermost in *Fig. 1.* *b e d* shews one End of the hollow Cylinder of the Tongue, thro' which its Axis passes.

The Length of the Tongue must be such, as will reach lower than just to touch the Bottom of the
great

great Hole as a Tangent: for, if it be not longer than that, it might happen, that when the Mortife is empty of Seed, and the Tongue set up close, a Wheel might, in Turning, or otherwise, go a little backwards, and cause a Notch of the Spindle to take hold of the End of the Tongue, and tear it out of the Mortife: Therefore let the Tongue reach a little below the Spindle, as the pricked Line *g b*, in *Fig. 3. of Plate 2.* doth.

As for the Posture in which the Tongue ought to stand in the Mortife, it is shewn by the Three pricked Lines in *Fig. 3. Plate 2.* where the pricked Line *g b* makes an Angle of Forty-five Degrees, being the nearest that it can stand to the Spindle; the pricked Line *i b* makes a somewhat greater Angle, and it is a mean (or middle) Distance from the Spindle; and the pricked Line *k b* is supposed to be its greatest Distance, where the Tongue makes its greatest Angle with the Top and Bottom of the Mortife. If the Tongue stood so obliquely as to make an Angle much less than Forty-Five, the Tongue would rise too much against the Bevel of the Mortife, and the Spring would have the greater Difficulty in returning it to its Place, when driven back by the Force of the Notches.

And beside, when the Tongue stood wide from the Spindle, there might be so much Room betwixt it and the Sides of the Mortife, that some Seeds might fall thro' there.

The Steel Spring is *D*, properly placed upon the Back of the Tongue, in *Fig. 1. Plate 3.*

At first, I made the Spring double, *i. e.* with Two Legs, in Imitation of that in the Organ, and fastened into its Tongue, much after the same manner as the Spring of the Organ is into its Tongue or Flap, which prevents the compressed Air from passing out of the Sound-board, except whilst the Key is thrust down

down by the Finger of the Player; but the Drill-spring requiring to be of a vastly greater Strength than that, I made it of Steel, of the Breadth of half an Inch, instead of Brass Wire: This performed very well, and several Drills are yet extant, that have only this Sort of Springs: Yet I found there was great Difficulty to set the Legs at their due Distance from each other; for their Seasoning would alter them from what they were, whilst the Steel was soft: They also took up too much Room in the upper Part of the Mortise. Then, to remedy these Inconveniencies, I made it single, with only one Leg, which by full Experience is found to be much better than the double one; it does not contain a Fourth Part of the Metal, and is most easily made, requiring none of that Trouble and Nicety that the double Spring doth. I shall therefore give a Description of the single Spring only.

B, the End of the Screw, which holds the Spring to the Tongue, thro' a Hole near the upper End of the Spring; D, the Middle, against which the End of the Setting-screw bears.

Its Length is almost the whole Length of the Tongue; the End E reaching very near to the lower End of the Tongue, and the End B is as near the upper End of the Tongue; as it can be placed without touching the Cylinder of the Tongue.

The Breadth is usually about half an Inch; the Thickness must be in proportion to its other Dimensions, and according to the Degree of Stiffness required.

The longer it is, the thicker it must be, to have the same Stiffness; but the broader it is, the thinner it must be of the same Length; so that it is hard to determine its Thickness. It is made stiffer or stronger by being cut shorter; it is made weaker, or less stiff, by filing or grinding it either thinner or narrower,

The common Thickness is about that of a Shilling (*a*).

The Degrees of Stiffness are measured in this manner; *viz.* Fix Two Boards together, leaving a Chink betwixt them, in one Place of an Inch long; lay the Spring (when seasoned across this Chink) with its Middle exactly over it; then put a String over the Spring, which may pass with both Ends thro' the Chink, and tie so much Weight to the Ends of the String under the Boards, that will pull down the Middle of the Spring, till it touch the Chink, and is strait with both its Ends; This will shew the Degree of Stiffness. But note, That the Spring must be crooked, and bear only upon its Ends, with the hollow Side upwards.

If ten or a dozen Pounds Weight pull it down to the Board, it is a good Degree of Stiffness, for a large Box: We are not confined to be very nice or exact in the Degree of Stiffness; for by our Fingers pressing it, we that are practised in it, know well enough, whether a Spring be of a sufficient Degree of Stiffness, without weighing it; but for such who are unacquainted with them, it is best not to trust to Guess, but Weights; and to adjust the Stiffness to that of a Spring, that has been known to perform well.

The Spring must bear against the Back of the Tongue at each End, and lie hollow in the Middle; But the Degree of Hollowness of the Spring is very material; for thereon depends the Distance of the Tongue's Motion towards the Spindle by Force of the Spring, and back again quite to the Setting-screw, by the Seed that is pressed against it by Force of the Notches, when they are moved by the Wheels; because the more the Spring is curved, the farther

(*a*) Not quite so thick as a milled Shilling, but rather of an old broad stamped Shilling, which is a little thinner,

will it thrust the Tongue from its Middle, if its Strength be superior to the Force that resists it, as it ought to be when a Notch is passed and before the next: This Motion of the Tongue is called its Play.

In order to measure the Distance (or Quantity) of this Motion, we must consider, that the Tongue, moving on its Axis above, describes with its lower End the Arch of a Circle, the Chord of which Arch is the Measure required.

To measure this by the Angle the Tongue makes at its Centre, would be no Rule for making Boxes; because some Tongues are longer, some shorter, in proportion to the different Diameters of the Spindles they move against; and yet the Play of the shortest must be as much as that of the longest, that is, it must describe as great an Arch at the Place of Pressure (described in *Fig. 3. Plate 2.*); and therefore the shortest Tongue would make the greatest Angle.

A short and easy Way, then, for a Mechanic to measure, is thus: Screw in the Setting-screw until the Tongue come within a quarter of an Inch of touching the Spindle; then take out the Spindle, and from the Centre of the Hole draw a Line on the Side of the Mortise, perpendicular to the Tongue, and at the Tongue's Edge make a Mark with the Compasses, or a Pen; then force back the Tongue against the Setting-screw as far as it will go (that is, until the Spring touch the whole Back of the Tongue); produce the said Line to the same Edge of the Tongue, or set the End of the Rule thereon, and draw another Line, by the Rule, from the Mark to the Edge of the Tongue, when farthest back, and there make the second Mark. The Ruler used this Way will shew both the Perpendicular, and the Measure.

But yet a quicker Way is, to set the Tongue, by the Setting-screw up to the Edge of the Hole; and, when it is forced back, measure from the Tongue

to the neareſt Part of the Hole; which will ever be a perpendicular Line drawn from the Centre of the Hole to the Place of Preſſure above-mentioned, and make another Mark there: Now the Diſtance between theſe Two Marks is the Meaſure (near enough) of the Tongue's Play at the Place of Preſſure. Tho' this Line drawn on the Side of the Mortiſe be not exactly perpendicular to the Surface of the Tongue; but only to its Edge; yet the Difference is next to nothing, and not to be regarded.

If its Meaſure be a quarter of an Inch, it is what Experience ſhews to be of a good Size for all Corn and Peas; a little leſs is no Harm, but greater is the moſt fatal Error, into which moſt of the Pretenders to the making of this Machine have fallen; they give the Tongue half an Inch, ſometimes Three quarters of an Inch Play. The Miſchief of this Error is yet farther increaſed, if the Spring be weak, if the Mortiſe have too great a Bevel, or if the Angle made by the Tongue at the upper Edge of the Mortiſe be too acute.

When the Tongue has too great Play, the Seed is apt to be turned out too faſt, or elſe too ſlow, in ſpite of the Driller. For when the Tongue is ſet at its due Diſtance from the Spindle, and is thruſt quite back by the Seed preſſed againſt it by the Turning of the Notches; but the Spring being unable to return the Tongue to its former Place at ſuch a Diſtance, at the time of paſſing the Intervals which are betwixt the Notches; then the Space between the Spindle and the Tongue being too open, the Seed is ſent down too faſt.

To prevent that, they ſet up the Tongue to the Spindle; and then, as often as the Spring happens to overcome the Force of the Seed's Preſſure (as ſometimes it will), it is ſent out too ſlowly.

The Inequality of the Running of the Seed makes ſuch Boxes uſeleſs, which the Expence of Two-pence (for

(for another Spring, or new Seasoning of that) at most would rectify, if the Maker understood how to mend his own Work. If time did permit, more should be said on this Point, because I find it is the *Pons Asini* of a Workman. Sometimes it may be prevented, when the Spring is too hollow, and gives too much Play. Screw the Screw, that holds it on the Tongue, down closer, so that the lower Part of the Screw's Head press against the Spring, and thereby force its Middle nearer to the Tongue, until you find its Play lessened to its just Distance.

The Spring, remaining in this compressed State, has lost the weakest, and retains only the strongest, Part of its elastic Force. Therefore, if you find it then too stiff, make it weaker by Filing or Grinding, or else put another into its Place, which is honestly worth no more than Two-pence.

This Holding-screw has a pretty broad Head, and is screwed in by a Notch, like the Screw-pin of a Gun-lock.

The Hole in the Spring must be somewhat bigger than the Holding-screw, because the Spring must have room to move and play thereon.

If the Middle of the Spring were against the Middle of that Part of the Tongue, that is betwixt its Axis and the Place of Pressure, the Distance of the Spring's Hollowness would be just half the Distance of the Spring's Play, to wit, the One-eighth Part of an Inch; but as the Spring does not quite reach up to the Axis, and reaches much below the Place of Pressure, the Hollowness at the Place where the Setting-screw bears against the Middle of the Spring at D, is considerably nearer to the Place of Pressure than to the Axis of the Tongue; this Hollowness of the Spring at the Setting-screw may be something more than the One-eighth Part of an Inch, to give the Spring a Quarter of an Inch Play: but it seldom has so much.

Fig. 4. in *Plate 2.* shews the Length and Thickness of the Steel Spring of a Turnep Seed-box: This serves both for a Tongue and Spring: It is made first strait, and then the narrowest End of it is turned round, till it reach to *a*, and forms the Cylinder *A*, thro' which its Axis passes; but is not welded or joined to the other Part of the Spring at *a*: It is placed in the Box with the Cylinder Part underneath. The Face of this Spring is seen upon its Axis, mark'd *K.* in *Fig. 5.* Its Axis is to pass thro' the Hole *E*, and screw into the Hole *F*, in *Fig. 2.* as is seen more plainly at *a* in *Fig. 9.*

As the Top of every Tongue ought to be even with the upper Edges of the Mortise, the Thickness of the Cylinder of the Brass Tongue causes the Hole in the Sides of the Mortise, into which it is held by its Axis, to be far enough from the Edges of the Mortise, to be bored and screwed without Danger of breaking the said Edges; but the Spring of the Turnep-drill being so very thin, there is some Difficulty in making the Hole so high, and near the Edges: To prevent which Danger, *Fig. 7.* shews the End of a small hollow Cylinder of Iron or Brass, of the Thickness of the Mortise; which, being put into the Cylinder *A*, in *Fig. 4.* raises the Spring higher above the Hole; so that it may be made as low in a Turnep Mortise, as that is which holds the Brass Tongue in the Wheat-drill. But we do not always use this inner Cylinder (*a*); but must then take the more Care in boring the Hole, or else it will burst out at the Edges of the Mortise.

Its Shape must conform to that of the Brass Tongue already described.

(*a*) For, instead of this, we may use a Bit of Woolen Cloth of the Breadth of the Mortise, glued on to the Bottom of the Hopper, which, filling the Vacuity above the Steel Tongue, prevents any Seed from running over it, though the Holes are bored as low in the Mortise as if the Cylinder *Fig. 7.* were to be used.

The

The Degree of its Stiffness is known by weighing, as has been directed for the other Spring; and being laid with its Face downwards over a Chink, with a small Piece of Wood of the Thickness of a Barley-corn at Each end, and a String taking hold of its Middle, and descending thro' the Chink, the Weight of Five Pounds, tied to the End of the String, will just bend the Spring, till it touch the Edges of the Chink; and this is the Stiffness of a Spring that has performed well, for many Years, in drilling of Turnep-feed.

The SETTING - SCREW.

Fig. 6. is the Iron Setting-screw, which passes thro' the Hole in the Fore-end of the Mortise, *Fig. 2.* and passes up to the Middle of the Spring by the prick'd Line *p q* in the same Figure. The Use of this Setting-screw is, to increase or diminish the Proportion of Seed to be turned out by the Notches; and this it does by forcing up the Spring and Tongue (where there is one) nearer to, or farther from the Spindle, whereby the Seed-passage is made wider or narrower, as is shewn by the Three prick'd Lines in *Fig. 2.* and *Fig. 3.*

Observe, that the prick'd Line *p q*, *Fig. 2.* (being the Mortise of the Turnep-box) stands higher than the same Line doth in *Fig. 3.* which is the Mortise of the Wheat-box. The Reason of this Difference is, because the Spring in the Wheat-box bears at its lower End against the Tongue below the Seed-passage, and at its upper End below the Axis of the Tongue, whereby the Middle of that Spring is lower than the Spring of the Turnep-box, which, being both Spring and Tongue, bears against its Axis above, and against the Seed-passage below; therefore its Middle is higher. This Setting-screw should be placed perpendicular to the Tongue when at its mean or middle Distance from the Spindle, which may be supposed to be the

middlemost of the Three mention'd prick'd Lines. This Setting-screw ought to be smooth and round at its End, which bears against the Spring; for, if it should have sharp Corners or Edges, the Spring might be wounded by them, and in time might break there, being press'd by every Notch that turns against it; and, as I have computed it, a Spring undergoes One hundred thousand of these Pressures in one Day's Work; and yet, in my whole Practice, I have had only one Spring broken, and that was in drilling a large Sort of Peas with a Wheat-drill, and was occasioned by a jagged End of the Setting-screw, which was not placed perpendicular to the Spring, by which means the rough End of the Screw made Scratches against it a Quarter of an Inch long, and so deep, that the Spring broke off there: Let not this Setting-screw be any longer than just to force the Tongue up to the Spindle; for, if it should be longer, an ignorant Driller might happen, by the Force of the Screw, to break the Tongue, or its Axis; but in the Turnep-drill, which has only a Spring instead of a Tongue, the Setting-screw may be a Thread or Two longer; because the Spring will yield a little to it, after it touches the Spindle, and is sometimes of Use in that respect, when the Notches are too large. This Screw must be of such a Bigness, that it may not be in Danger of bending; for if it should be bent, it could not be screw'd up with any Certainty, because its End, being crooked, would be below its Place at one Half-turn, and above it at the other Half-turn, and so the Spring might be set farther from the Spindle instead of nearer, and nearer instead of farther, by the Crookedness of the Setting-screw. Its Head may be made with a Notch in it, to be screw'd in with a Knife, or else with a Head like a T, to be turn'd with the Fingers, which I think is best, especially for a Wheat-drill; because as the Brine and Lime, which stick on the Wheat, grow

drier, it will run faster; and therefore the Setting-screw must be frequently screw'd in to lessen the Seed-passage.

The Seed-passage, or Place of Pressure, is where the Seed passes down betwixt the Spindle and the Tongue; and is in that Part where they are nearest together; for there the Seed is press'd hardest by the Force of the Notches, which carry it down: And this Passage is higher or lower, as the Tongue stands nearer or farther from the Spindle; for as it stands wider, it becomes nearer to perpendicular to the Top of the Morise, and then the Seed-passage is higher; and when it stands nearest to the Spindle, then the Seed-passage is lowest. This appears in *Fig. 3.* by the Three prick'd Lines *a n*, *a o*, and *a p*.

The Spindle, with its Notches, is best shewn where it is large, and made of Wood, as that of the Wheat Seed-box; it is a solid Cylinder that passes thro', and fills the great Hole, or hollow Cylinder, of the Seed-box; it is of various Lengths, according to the Distance its Wheels go asunder; it is always in large Boxes the Axis of Two Wheels, and turns round with them, as the Axis of the One Wheel of a Wheelbarrow does with that: These Wheels, by their Circumferences, measure out the Ground over which they carry the Seed-box, and, by the Notches in their Axis, deliver down the Seed equally, whether they move swift or slow; because an equal Number of Notchfuls of Seed will be deliver'd thro' the Seed-passage at each Revolution of the Wheels.

The Notches resemble those in the Hinder-Cylinder of a Cyder-mill, which break the Apples by turning against the Notches of the Fore-cylinder, as our Notches turn against the Tongue; and bruise the Apples which come betwixt them, as our Notches might sometimes bruise soft Seeds, if the Tongue stood close to the Notches, without any Spring behind it to give Way to their Pressure, and return the Tongue again

to its Place, at every Interval betwixt Notch and Notch.

The best Way, that I can think of, to shew the making of these Notches, is by a Section of the Spindle at right Angles, in the Middle of the Notches, as in *Fig. 4. of Plate 3.* which is a Circle whose Circumference is cut off by Six Notches; which shew the different Sort of Notches, that increase or diminish the Proportion of Seed to be carried thro' the Seed-passage by them: The Length of the Notches we never alter; but make them always parallel to the Axis of the Spindle, and of the Length of the Distance there is between the lower Ends of the opposite *Axes transversæ* of the Ellipses, or great Holes, of the Mortise; for if any Part of the Surface of the Spindle should be betwixt the End of a Notch and the Hole, one or more Seeds coming betwixt that Surface and the Tongue, might hold it open, and prevent its pressing against the Notch, to hold the Seed therein from falling without the Turning of the Wheels.

This Proportion of Seed is alter'd by the Number of Notches, and by their Depth or Breadth, or by both. *b c* is the Depth of a Notch, which we call its Side; and is that which takes hold of the Seed, and carries it down thro' the Seed-passage. The Manner of cutting this is seen by its being a Portion of the *Radius A c*. The Bottom of a Notch is made in different Forms (*a*): As, first, it may be convex,

as

(*a*) The convex Form is best for turning out a great Proportion of Seed; because such a Bottom may be broader than one of any other Form, in a Notch of the same Depth and Capacity; and such a Notch, having its Capacity more in Breadth than Depth, will be less liable to let fall any Seed without the Turning of the Wheels, than a Notch that is deeper and narrower, except it be very narrow, which it cannot be for throwing out a large Proportion of Seed; for a great Number of Notches cannot have altogether the same Capacity as a lesser Number of the same Depth

as is shewn by the curve Line $b d$. We may enlarge the Capacity of this Notch, by taking off the Convexity of its Bottom, as in the Bottom of the Notch shewn by the Line $e f$; and if we would increase it more, we make it concave, as $g b$.

But of whatever Sort or Dimensions one Notch is made, all the rest should be the same exactly; and consequently, the Interstices (or Intervals) between Notch and Notch, of which the Line $f c$, being an Arch of the Circle, is the Breadth, must be equal (a), and cannot be otherwise, if the Notches are all equal and equidistant, as they appear in the adjoining *Fig. 5*. which is a Section like the former, and shews Six Intervals, with their Six Notches, of the Size wherewith we drill St. Foin with high Wheels; but when we would drill very thin, it is better to have but Four or Five Notches instead of Six.

Fig. 6. shews a Notch of the Spindle. $a b$ is the upper Edge of the Side of the Notch, being always an acute solid Angle. $c d$ is the Edge of its Bottom, being always an obtuse Angle. $e f$ is the Angle made by the Side and Bottom, and is always shorter than the aforesaid Two Edges, by reason of the Obliquity of the Two Ends; this Angle is never obtuse, except when the Bottom of the Notch is concave. These Three Lines must be parallel to the Axis of the Spindle.

Fig. 7. is one End of the afore-described Notch; the Line $a b$ being joined to the Line $f d$ of *Fig. 6*.

Depth may. The concave Notch, if it were as broad as the convex may be, would make the Interstice, that is before it, liable to be broken out, and so Two Notches would become One; but the Convexity of the other supports the Interstice like an Arch, and for that Reason may be made to reach almost quite to the Notch that is before it, without that Danger.

(a) But these cannot be equal, unless the Notches are all of equal Breadth, and equidistant from one another; and if they are otherwise, the Seed will not be equally delivered to the Ground.

and the Line $a c$, being joined to the Line $b f$ in *Fig. 6.* would be the End of that Notch in its proper Posture; and then the Line $b c$, being an Arch of the cylindrical Spindle, would be the Edge of the upper End of the Notch. $a b c$, being the Area of this End, is a Plane, and, when in its Place, makes an Angle of Forty-five Degrees with the Axis of the Spindle. The other End is the same with this in all respects, except that, being opposite to it, it is inclined to it in an Angle of Ninety Degrees, at the bottom Angle of the Notch, at the Line $e f$ in *Fig. 6.*

Fig. 8. is a Notch lying with its Ends near it, and is of the same Dimensions with those appearing in the Seed-box, *Fig. 3.*

The Cover *B* appears with its upper Surface rightly placed in the Mortise, in *Fig. 3.* of *Plate 3.* where its Breadth is shewn to be the same with that of the Mortise; but its Shape, and other Dimensions, are best seen in *Fig. 3.* of *Plate 2.* where $f t$ is its Length, and reaches from the Hinder-end of the Mortise, to within the Tenth of an Inch of the upper End of the *Axis transversus* of the Ellipsis; its greatest Depth is from v to w , and is made so deep, that its Bottom, at w , bearing against the End of the Mortise, may prevent its Point, which is at t , from sinking down to touch the Spindle, which it neither must do, nor be so high above it as to suffer a Seed to pass between the Spindle and it, tho' the Seed is not apt to pass that Way, because the Notches throw it forwards from the Cover. z is the Hole, thro' which an Iron Screw-pin passes, and screws into the opposite Sides of the Mortise, to hold it firm in its Place: 'Tis made so thin betwixt x and y both for Lightness, and that the Seed may come the more freely to the Notches, without Danger of Arching at that End. The Use of the Cover is to prevent any Seed from falling down behind the Spindle.

Fig. 10. Plate 2. is the Fore-end of a Wheat Mortise, with its Hole *A*, thro' which the Setting-screw is screw'd, and pass'es up to the Back of the Tongue by the Line *qr* in *Fig. 3*.

Fig. 9. in *Plate 3.* is the hinder End of a Wheat Mortise, which by its prick'd Lines, and the Two right-angled Triangles they make, shews the Bevel of the Mortise, and also its Depth; it also shews the Difference of the Bevel of the Mortise, and that of the Tongue, *Fig. 1.* which is placed against it: These Figures having been already demonstrated in the Description of the Turnep Mortise, and in these, I need say no more of it, but that I think these last-mention'd Figures sufficient Directions for understanding and making the Mortise of a Wheat-drill.

Fig. 3. of *Plate 3.* exhibits to View a Wheat Seed-box, with its Appurtenances, standing upon its Bottom; *B* the Brass Cover; *C* the Tongue hanging upon its Axis; *c* the End of the Iron Screw that holds on the Spring, coming thro' the Tongue, and filed smooth with it; *a, a, a,* are Three Notches of the Spindle, with their bevel Ends; *b, b,* are Two Interstices betwixt the Notches.

Hitherto we have been speaking of the Parts contained in the Wheat Seed-box; let us now come to the Parts containing: As, first, *d e f g* is the upper Surface of the Brass Seed-box, shewing the Top of the Mortise, and what it contains; *b b b,* and *b b b,* shew the Ends of the hollow Cylinder, and its Bases coming out on each Side, farther than the Box; for if it did not project farther out than the Sides of the Box, the Surface of it would be so narrow, that it would cut the wooden Spindle by the Friction made between it and the Spindle; but the Surface, being of this Breadth, never wears into the Spindle, but makes it smooth and shining; *i i i,* and *i i i,* shew a Portion of the wooden Spindle (of an Inch and an

half Diameter) coming out of the hollow Cylinder, on each Side of the Brass Box.

The Spindle is kept from moving end-ways, by Wreaths, in the same manner as the Axis of a Wheelbarrow is; which Wreaths shall be described together with the Hopper. *k* is the Hole by which the Fore-end of the Seed-box is held up to the Bottom of the Hopper, by a Screw and Nut. *l* is the Hole where the Hinder-end of the Box is held up, in the same manner as the Fore-end is. *m n o p* shew where the Two Halves of the Seed-box are joined together.

Fig. 10. shews the Outside of One Half of the Brass Seed-box. *A A A* shew the Thickness of the projecting Base of the hollow Cylinder, which is made the thicker, to the end that the Hole may be bored large, and made an Inch and Three Quarters Diameter, when a Spindle that is to go therein is required to be of that Bigness, by reason of its extraordinary Length, as it is in the Fore-hopper of the Wheat-drill. *B C* shews the Thickness of the Ends of the Seed-box, whereby it is held up to the Bottom of the Hopper; if they are not quite a quarter of an Inch thick, they will be strong enough; especially *C*, which is the hindermost, and which is never pull'd down by the Turning of the Spindle, but is rather raised up by it.

D is the Head of the Counter-screw, to be turn'd by the Fingers, to press against the Side of the Setting-screw, to keep it from turning of itself, when it is worn loose.

E is the Hole for the Axis of the Tongue. *F* is the Hole of an Iron Screw-pin, which both holds the Cover to its Place, and also the Two Halves of the Box together. *G* is the Hole for another Screw-pin, which holds the Two Sides of the Box together. *H* and *I* are Holes for Two other Screw-pins, which likewise hold the Two Halves of the Box together,
and

and are placed one above, and the other below, the Setting-screw; for otherwise that Screw, and its Counter-screw, might force open the Joining of the Box, and then the Setting-screw might be loose, and the Bevel of the Box might be altered; but these Screws, being one on each Side of it, prevent this Inconvenience.

Fig. 8. in *Plate 2.* is one Half of a Brass Turnep Seed-box, lying with its Inside uppermost, which shews the left Side of the Mortise, and half the Fore-end, and half the Hinder-end, of the Mortise, and half of each Screw-pin Hole, by which it is held up to the Bottom of the Hopper. A is half the Hole of the Setting-screw, shewing in the Middle of it the End of the Counter-screw. B is half the Hole, by which the Steel Spring-cover is held in with a Screw. All the other Holes are for the same Purposes, as have been shewn in the Wheat Seed-box.

Fig. 9. is the whole Turnep Seed-box, standing upon its Bottom; Part of its Steel Spring-tongue appears in its Place, as also some of the Notches of the Spindle; but more especially the Cover A, which differs from the Cover of the Wheat Mortise, this being a very thin Spring, whose lower End just reaches to touch (but not to bear upon) the Spindle at the upper End of the transverse *Axes* of the Ellipses; the Mortise being filed away at the End, in order that the upper End of this Spring, and the Screw which holds it, may not lie above the upper Surface of the Box. This Spring is made very weak, to the end that, if by any Chance a soft Seed should stick in a Notch, and be turned round, this Spring might suffer it to pass by without breaking it. B, C, are the Two Flanks or Sides, made necessarily of this Breadth, for bearing against the Wood of the Bottom of the Hopper, to prevent the Seed from falling out betwixt the Wood and the Brass, and that the Hole in the Hopper may be broader than this narrow Mortise

tise of the Seed-box. The left Flank B, being next the wide Side of the Hopper, lies all open, except on the outside of the pricked Lines, where it is covered by the Wood of the End of the Hopper, when it is screwed on to its Place; but the Flanch C, on the right Side, will be all covered by the End of the Box, that will stand upon it, and will reach to the pricked Line that touches the Edge of the Mortise. D is the End of the Setting-screw, appearing in its Place with a Notch, whereby it is to be turned by a Knife; but I think it better to have an End like a T, to be turned with the Fingers. E is one End of the hollow Cylinder, which projects beyond the Flanch, that there may be more Room for the Crank to turn (without striking against the End of the Hopper, or against the Flanch) on the Outside of the Box or Hopper; and for that, the longer this Cylinder is, the better the Brass Spindle will turn in it.

Fig. 11. is the Spring-cover, with its Hole, whereby it is screwed into its Place, as it is seen marked A, in *Fig. 9.*

Fig. 12. is the Setting-screw pointing against its Hole, its Head being flat, that it may be turned by the Finger and Thumb.

Fig. 13. is the Counter-screw, to be turned in the same manner.

Fig. 5. shews the Brass Spindle of the Turnep Seed-box, and the Manner of turning it against its Steel Tongue, or Spring; which Manner is different from that of turning the larger Spindles for Boxes of a larger Size, such as the Wheat Seed-box.

This Spindle (*a*), being but half an Inch Diameter, is too small to be turned by the Two Wheels, as the

(*a*) I believe, if it were less by a Fourth or Third of its Diameter, it might be better, as being more proportionable to the Smalness of the Turnep-feed. I have had the Mortise much wider; but it cannot well be made much narrower, whilst the
Tongue

the larger Spindles are; not only because it would be in Danger of breaking by the Weight of the Hopper, and by the Twisting (or Wrenching) of the Wheels; but also because it would soon become loose, by wearing the hollow Cylinder thro' which it passes; and it would be apt to open the Brass Flanches from the Bottom of the Hopper, whereby the Seed might run out, beside several other Inconveniencies; all which are prevented by turning the Spindle in the manner shewn in this Figure; for here the Spindle never presses against the hollow Cylinder, with any greater Force than that of its own Weight, which is so very little, that the Friction made by it is next to nothing.

A the Spindle, exactly fitting the Bore of the hollow Cylinder; which, when it enters the said Cylinder at its left End, in *Fig. 9.* will be stopped by the Wreath *B B B*; which Wreath, being circular, is cast on the Spindle, and is Part of it; the other End of the Spindle will then appear without the right-hand End of the said hollow Cylinder, at *E* in *Fig. 9.* and is kept there by the Wreath *Fig. 14.* which is to be put on upon the End of the Spindle, until it come to the Shoulder at *a*, which Shoulder is exactly even with the End of the hollow Cylinder; so that this Wreath will touch the End of the said Cylinder by its whole Surface. Then, to fix in this Wreath from coming off, we make use of the Slider, *Fig. 15.* whose Two Claws *A, B*, being thrust down by the Two Notches of the Spindle, at *b* and *c*, until its other Part

Tongue is of this Fashion; for this Steel Tongue, if narrower, would either be too stiff, or else apt to break, nor would there be Room in the Mortise for a sufficient Setting-screw to follow it. But there is another Fashion, wherein a narrower Brass Tongue has a broad Spring behind it; and when it is in this Manner, the Mortise may be a Fourth of the Breadth of this. I have had many of these when I made my Boxes in Wood; but cannot describe them by these Cuts; neither are such narrow Mortises necessary, unless it were for drilling Tobacco seed, Thyme-seed, or some other Sort of an extraordinary Smalness.

C, which is perpendicular to its Claws, comes down to the Flat of the Spindle, and environs one half of the Hole, covering the Part of the Flat which appears of a darker Colour; and then the upper Part of C, in *Fig. 15.* makes one level Surface with the Flat D of the Spindle; and then the Iron Fork E, being screwed into the Hole F, holds down the Slider fast, so that it cannot rise up; and then the Spindle, being in its Place, will run round without moving endways, being confined by these Wreaths.

The Spindle being thus placed, so that it may turn easily, we place the Seed-box upon its Flanches with its Bottom upwards; and then setting one sharp Point of a Pair of Compasses, or some such Instrument, upon the Spindle, within the Mortise, close to the Edge of the Hole or Ellipse at the End of the transverse Ax, turn round the Spindle, until the said Point makes a Mark round the Spindle, which will be a Circle; by the same means make such another Mark at the opposite Ax; then unscrew the Fork, and take out the Slider, pull off the Wreath, and take out the Spindle, and cut the Notches between the Two said Circles and Marks; the Edges of the Ends of the Notches must be Arches of these Circles. These Notches should differ from those already described in the Wheat-drill, in nothing but the Smallness of their Dimensions; their Depth should be about the Thickness of a Turnep-feed, or something deeper. The Breadth of their Bottoms is uncertain, and must be greater or less according to their greater or less Number; but we commonly have Seven or Eight Notches, and make them about the Breadth in which they appear in this Figure; but whatever their Number be, they must be all equal, and so must all their Interstices.

G is the End of a wooden Spindle, thro' which passes the Iron Crank H. and is fastened to it by its Screw and Nut, at *d*; Part of which Crank enters the

the

the Wood at *e*, which prevents its Turning in the Spindle.

This Crank, by its other End, passing thro' the Two Legs of the Fork *E*, and equally distant from the Top and Bottom of it, turns the Spindle by the Motion of the Wheel which is fixed on the other End of the wooden Spindle. If this Crank were to turn the Spindle by a single Pin, instead of this Fork, the Seed could never be delivered out equally to the Ground; for as soon as the Pin began to descend, and decline from being perpendicular to the Horizon, it would, by its own Weight falling down, turn the Spindle half round in a Moment, and there remain with its other End downwards perpendicular to the Horizon under the Spindle, until the Crank reached it there, and so no Seed would be turned out by one Semicircle of the Wheel, and a double Proportion would be turned out to the Land that was measured by the other Semicircle; but the hinder Leg of the Fork, bearing against the hinder Part of the Crank, prevents this Inconvenience.

The Line *f g* is Part of the Surface of a Board, thro' which the wooden Spindle passes, and by which it is held in its Place; as shall be shewn hereafter.

The Axis of this wooden Spindle ought to fall into a Line with the Axis of this Brass Spindle; but, unless Care be taken to prevent it, the wooden Spindle will so much wear the Hole thro' which it passes, and be worn by it, as to have Room in the Hole to deviate from this Exactness, and may descend so low, that the Crank may come out of the Ends of the Fork; and for this Reason it is, that the Fork is made so long as it is; but when this wooden Spindle does, by the Contrivances hereafter shewn, keep its Axis in a Line with the Axis of the Brass Spindle, or very nearly so, then the Legs of the Fork need be no longer than half an Inch; and in that Case, the Joint of the Crank, which is perpendicular to the
Spindle,

Spindle, must be shorter, or else descend deeper into the Wood, so that its End, which turns the Fork, may be in the Middle betwixt its Bottom and the End of its Legs.

The Use of the other End of the Spindle is this: When we have a mind that it should be turned by the left Wheel instead of the right, we screw in the Fork into the Hole I, and place a short Screw in the room of the Fork, to hold down the Slider.

Note, It is not absolutely necessary, that the hollow Cylinder, which appears on the Sides of the Seed-box, should both, or either of them, project farther than the Flanches; but I think it better that it should do so, at least, on that Side which is next to the Fork.

This Cylinder should be bored as true, and as even, as the Barrel of a Fusil is bored: and the Edges and Surfaces of its Ends must be smooth, and without Jaggs, to the end that the Wreaths may turn glibly against them.

The Figure or Shape of all Sorts of Seeds disposes them, more or less, to form an Arch, when they are pressed from above, and confined on all Sides.

The most effectual Way to prevent this is, to take care, whenever many Seeds are to descend together by their own Gravity thro' a narrow Passage, that such Passage be never narrower downwards than upwards; but, on the contrary, that it be wider downwards, on some or one of its Sides; in which Case, if the Surfaces of all the Sides of this Passage be smooth, it is impossible, that Seeds should of themselves form an Arch therein.

On this Maxim depends the infallible Performance of a Drill, and from hence are derived the Uses of the Bevel of the Mortise: What I mean by the Word Bevel, in general, has been already defined.

The Bevel of the Mortise of the Seed-box is that Inclination of its Sides, whereby it is wider downwards,

wards, and narrower upwards; by which means the Seed is prevented from arching in the Mortise before it descends to the Notches of the Spindle. And this is the First Use of our Bevel; for this Arching might happen in the Mortise, if the Planes of its Sides were parallel to each other; and would be unavoidable, if their Inclination were downwards, as it is upwards; but these Planes opening downwards, the lower the Seed descends, the more Room it has to expand; so that the very Weight, which would otherwise cause it to arch and stop, does by means of this Bevel force it to descend to the Notches, and then it is safe from all manner of Danger of stopping. The Ends of the Mortise are at such a great Distance from each other, and the Cover so very thin, as to lie almost even with the upper Part of the Spindle, that the Seed can never form an Arch that way; or, if it did, the continual Motion of the Tongue would immediately break it down at the Fore-end of the Mortise.

The Second Use of this Bevel is, that it gives room for the Tongue to be in the same manner bevel, tho' in a less Degree: By this means, the Seed cannot by any Impediment be stopped in its oblique Descent to the Notches, from the Fore-end, and all that other Length of the Mortise, along and upon the Surface of the Tongue.

But if the Mortise had not this Bevel, the Tongue could not have it; for then either the upper Surface of the Tongue must have no Bevel at all, which would destroy the Two empty Triangles which ought to be on its Sides; or else it must have a Bevel the contrary Way (*i. e.* a Bevel reversed), and be narrower downwards than upwards, which would cause the Seed to arch thereon, and hinder its free Descent to the Notches.

A Third great Use of this Bevel is, that, besides the Bevel of the Tongue aforementioned, it gives place for Two empty Triangles, one on each Side the
Tongue,

Tongue, which have each its vertical Angle extremely acute at the Axis of the Tongue, and have their Bases at the Bottom of the Mortise, and of the Tongue: These Triangles are also Bevels, which consist of the Difference, or Complement, of the Bevel of the Tongue, and that of the Mortise, the latter being about One-third greater than the former; *i. e.* One-third of the whole Bevel of the Mortise is divided between these Two Triangles, to each a Sixth Part; so that if the Angle of Inclination of the Sides of the Mortise were Nine Degrees, then the vertical Angle of each of these empty Triangles would be of One Degree and Thirty Minutes, and Six Degrees, would be left for the Bevel of the Tongue. And these triangular Spaces help to secure the free Motion of the Tongue, and free Descent of the Seed down its Surface; because they permit no Impediment to lodge in them, they being, by means of the Bevel of the Mortise, wider downwards, both obliquely and perpendicularly, so that no Dust, nor whatever else happens to get in betwixt the Tongue and the Side of the Mortise, can rest there; for it will be immediately removed thence by the Motion of the Tongue, and its own Gravity, and either thrown perpendicularly down, or else obliquely to the Notches, and the first Notch that takes it will carry it out at the Seed-passage.

The Fourth Use of the Bevel is, that thereby the Sections of the hollow Cylinder (before described) do form Ellipses instead of Circles; which they must have been, if cut parallel to the Bases of that Cylinder; and the Sections must have been thus parallel, had the Mortise been without any Bevel.

Now the Two Semi-ellipses, which are on the Fore-sides of their longest Axes or Diameters, and next to the Tongue, are opposite to, and do still uniformly depart from each other, even from the upper End of their said longest Axis, until they
arrive

arrive at the lower End of the same Axis, which is below the Seed-passage, as its upper End is very near the Cover.

This Opening of these opposite Semi-ellipses makes it impossible for any thing, of itself, to get into the remaining Parts of this hollow Cylinder, betwixt them and the solid Cylinder, call'd the Spindle, which turns continually therein, when the Wheels are going: For you will see, that if you make a Mark on the Spindle, close to the Side of the Mortise, at the upper End of the longest Ax of the Ellipse; and then turn the Spindle until this Mark come against the lower End of the same Ax; and there make another Mark on the Spindle, close to the Side of the Mortise; and draw a Line from one Mark to the other, parallel to the Ax of the Spindle, which will be the Measure of that Part of the Bevel of the Diameter of the Hole; every Point in this Line will, by an intire Revolution of the Spindle, generate a Circle, which will cut the Ellipse in Two Places, once on the Fore-side of its longest Axis, and once on the Back-side or hinder Half of it; and that all these Points, in this Surface of the Spindle, described by these Circles, will enter the Hole, by the said hinder Semi-ellipse, as the Spindle there turns upwards (as it always does); and they will all again come out on the fore Semi-ellipse, as they descend towards the lower End of the said Ax of the Ellipse.

As these Points thus come out of the Hole, or (if I may use the Expression) as they emerge, they oppose every thing that would enter the Hole, they still moving from the Hole, and push away from it whatever they meet; nay, if any thing were in the Hole, these Points (whereof this Surface consists) would bring it out by this Semi-ellipse, which is always press'd by the Seed when the Drill is at Work; but as these Points immerge by the other Semi-ellipses which is behind the Spindle, they can carry with

them into the Hole nothing but Air, because the Cover never suffers any thing else to come there from above; and the Seed falls out of the Notches by its own Gravity, just before it reaches the lower End of the transverse Ax, being the Place where the opposite Ellipses are farthest asunder; and none of it is ever carried so far back as the hinder Semi-ellipses; and therefore nothing can be carried into the Hole from below.

Thus that Part of the Surface of the Spindle will keep the Hole empty and clear, before ever any Notches are cut; but when the Notches are made on the Spindle, they have yet a much greater Force to drive and expel whatever would enter the Hole, their Shape being such as nothing can enter against their bevel Ends; but what is at their Ends will be thrown presently into the Mortise; insomuch that when a Spindle has been too little for the Hole by a Quarter of an Inch, that is, a sixth Part of the Diameter of the Hole, it will perform very well in drilling large Species of Seeds; and when the Mortise is run empty, nothing at all is found in the Hole, it being thus kept void and clean by the Notches.

Note, That what is here, and elsewhere, said of the Ellipse of the one Side of the Mortise, must be understood the same of its opposite Ellipse, on the opposite Side of the Mortise.

All these Advantages accruing from this Bevel of the Mortise, I believe that, without it, all Attempts of making a Machine to perform the Work, which this does, would have been vain.

There is also within the Mortise unavoidably another Bevel, which is as the Reverse of the former, and notwithstanding is as useful; and this Bevel is, the Inclination which Part of the curvilinear Surface of the Spindle, beginning a little above the fore End of the shortest Diameter of the Ellipses, and descending down to the Seed-passage, has to the lower Part of
the

the Surface of the Tongue opposite against it. These Two Surfaces meeting one another below, when the Tongue is set up close to the Spindle, form a mix'd Angle, which stops up the Seed-passage, except when a Notch comes against it.

When the Tongue is set from the Spindle, to the Distance of several Diameters of one of the Seeds that are to be drill'd, this revers'd Bevel causes the Seed to arch at the Seed-passage, and stop there, till the Notches force it thro', which would, without this Arching, fall out by its own Gravity, without the Turning of the Wheels.

The Seed arches here the more firmly, the more it is press'd upon by the incumbent Seed from above it; and the former Bevel (which I call the Bevel of the Mortise) permits the incumbent Weight to press the harder on the Seed that is near the Seed-passage; and this might be reckon'd a fifth Use of the former Bevel: For as it prevents the Seed from arching in any other Part of the Mortise, so it does, by the same means, cause it to arch the more strongly at the Seed-passage, which is sometimes (*viz.* when the Tongue must be set wide) as necessary, as it is for it to escape arching before it comes thither. And the more strongly this Arch presses against the Tongue, the more the Tongue by its Spring presses against it; and this Pressure being reciprocal and equal, the Seed cannot fall out spontaneously; for when the Passage is thus wide, if you throw into the Mortise a few Seeds, suppose Five or Six at a time only, they will all pass through immediately, without any Motion of the Wheels; but if you throw in a large Quantity together, there will only a few of the lowermost fall through, unless the Wheels do turn and throw them down by the force of the Notches.

Indeed we do not care to set the Tongue so very wide from the Spindle, unless it be when we are obliged to plant a very much larger Proportion of Seed

than the Notches are design'd for, and when we have no Opportunity of changing the Wheels for such as are lower, nor of changing the Spindle for another that has greater or more Notches in it.

Four-and-twenty Gallons of large Peas are as proper a Proportion to drill on an Acre, as Six Gallons of Wheat are.

There are divers Ways to vary (*i. e.* increase or diminish) the Proportion of Seed; as, First, by the Setting-screw, with which we can, without any Inconveniency, set the Tongue so far from the Spindle, as to permit one Round of the Notches to turn out Four times the Quantity, as it will do when the Tongue is set close up to the Spindle; and thus we can vary the Proportion by innumerable intermediate Degrees.

Next, if we would increase the Proportion yet farther, we can enlarge the Notches; but we cannot add to their Number, unless there be room to double it, by making a new Notch between every Two; but we cannot diminish the Proportion of Seed by the same Notches, because they cannot be made lesser or fewer.

If we would make any other Alteration in the Proportion of Seed by the Notches, it must be done by making another Set of them; which we may do, because the wooden Spindle may have Three Rows of Notches in it, of which we may use either, by moving the Wreaths and Wheels towards one End or the other of the wooden Spindle; as shall be shewn in the Descriptions of the Hoppers.

But as for the Brass Spindle of the Turnep-drill, we can have but one Set of Notches in it (*a*): And there-

(*a*) But by putting on a Wreath (that is a little broader than the Mortise) upon the Spindle (made longer for that Purpose) we can, by changing this Wreath from one End of the Spindle to the other, have Two sets of Notches of different Sizes, and of different

therefore, tho' we can increase the Proportion of Seed by enlarging the Notches, or perhaps by doubling their

different Numbers in it: Or if we would have Three Sets, we need only make Use of Two such Wreaths, and let the Spindle be long enough to receive them. So we may use which Set we please.

Tho' several Sets of Notches may be useful to those who drill many Sorts of fine Seeds different in Magnitude in a very great Degree; yet I never found more than one Set of Notches necessary in this Spindle.

Nor have I used any more than one Set of Notches in one Mortise of any Sort; but in a wide Mortise, there may be made a double Set of Notches, consisting of Two Rows, all of equal Bigness, and half of the Length, and double the Number of a single Row, one End of each Notch reaching to the Middle of the Mortise, and pointing against the End of an Interstice, that is between Two of its opposite Notches.

If ever there shall be Occasion for this Sort of Notches, it must be when a great Proportion of Seed is to be drill'd by a small Spindle, and low Wheels: The Smalness of the Spindle may not, by a single Set, admit of a sufficient Number of Notches (of a proper Bigness) in its Circumference; not that a double Set, by its double Number, will throw down a greater Quantity of Seed than a single Set of the same Width and Depth, but a less Quantity: But it may be feared, that a very small Number of Notches might not spread the Seed so much as to cause it to lie even in the Channels, one Notchful falling all to the Ground, before any of the next Notchful reaches it, which would make Chasms or Gaps in the Row of Corn or Legumes: This, such a double Number of Notches will certainly prevent.

It would seem, that the higher the Wheels, the more need there should be for this double Set of Notches: But it appears to be otherwise; for the greater Distance the Seed has to fall, the more it spreads, and strikes oftener against the Funnel and Trunk; and by that means a Notch from high Wheels will, with the same Quantity of Seed, supply a greater Length of the Chanel (or Furrow) than a Notch will from low Wheels.

In all my Practice I never had any Occasion for such a double Set of Notches, either with high or low Wheels, or even when I drilled into open Channels, without Funnels or Trunks to my Drill-plough; and yet my Rows of St. Foin, and of Corn, were always free from Gaps, being equally supply'd with Seed from one End to the other.

If ever there is Occasion for more than a single Set, it must be for Beans, for which also I think a large Spindle is better than a

their Number; yet we cannot lessen the Proportion of Seed by the Notches, unless we have a new Set of them, and that will occasion a Necessity of having another Spindle; but, as to the Setting-screw of the Turnep-drill, it will increase the Proportion of Seed with the same Notches, much more than the Setting-screw of the Wheat-drill will do.

The other Way of varying the Proportion of Seed in the same Boxes, is by the Diameter of the Wheels, when we can alter them; for Wheels, of what Diameter soever they are, must turn round all the Notches at one Revolution; so that Wheels of Twenty Inches Diameter will deliver out a third Part more Seed than Wheels of Thirty Inches Diameter, into the same Length of the Channels; but we seldom have any Occasion to alter the Wheels, unless it be on account of planting a Species of Seed of a different Magnitude, as the largest Sort of Peas, and small-grain'd Wheat, or St. Foin Seed are.

These are all the Ways we have to alter the Proportion of Seed, we drill with the same Seed-boxes;

double Set of Notches in a small one. The largest Spindle I have known made, is of Two Inches and an half Diameter, and that only for Horse-Beans.

The best Sort of Notches for a double Set are those which have convex Bottoms; because such are less liable to drop their Seeds without the turning of the Wheels, than any other Sort: And a double Set must be in greater Danger of this, as the Tongue is always hindered from pressing so closely against any Notch, being held open by the Seeds on the opposite Interstice; which is contrary to a single Set, where no Seed can lodge at either End of a Notch, to hold open the Tongue, or hinder its pressing against it.

Note, When I made my Boxes of Wood, I had double Boxes, with a Partition between such a double Set of Notches; but never made such in Brass, not knowing whether that Partition, by its Thinness of hard Metal, might not cut the Spindle: Yet I never found any Occasion for a double Row of Notches. I made those double Boxes only for drilling Two Sorts of Seeds at once into the same Channel.

these

these Two Sizes, already described, being sufficient for all Sorts of Corn and Seeds which we commonly sow, from Marrow-peas to Turnep-feed; but, for drilling of Beans, the Boxes must be larger, and are commonly made of Wood, the Spindle Two Inches Diameter, or more, and the Boxes Two Inches wide: Where note, That this Increasing of the Width of the Mortise, from an Inch and an half, to Two Inches, increases the Quantity of Seed to almost double; because this Half Inch is all added to the Middle of the Notches, where they are deeper than their Ends; the Bevel of which takes up a considerable Part of the Length of the Notches. For Beans, they also contrive to have their Wheels as low as conveniently they can. These Wooden Drills are now become common in many Places.

The Wooden and Brass Seed-boxes differ not in any of the most essential Parts of them; only the Wooden Box must be thicker, as the Wood is not so strong as Brass; the Spring is made strait instead of crooked; and, being let into the Back of the Wooden Tongue, bears against it at each End; and the Chanel, into which it is placed, being made hollow in the Middle, the Spring has its Play there, and must be stiffer and have a little more Play in the Bean-drill, than in any lesser Seed-box.

I, at first, made all my Seed-boxes of dry Box-tree Wood, which performed very well, and are still used: But, a few Years ago, a Gentleman advised me to make them in Brass; the doing of which has put me to a great deal of Trouble and Expence, for want of understanding the Founder's Art: Yet this I do not repent, because they are, in some respect, better than those made in Wood; especially to those who do not well understand their Fabric; for, to such, the Swelling and Shrinking of the Wood was inconvenient in small Boxes: And I now am told, that they are cast in *London* of the best Brass, at the Price of One

Shilling *per* Pound, and so smooth as to require very little filing. And these Brass Boxes being also more lasting than Wood, and not much more expensive, when Workmen know how to make them, I think it not worth while to give any particular Directions for making them in Wood.

As to the Spindles of the Turnep-boxes, I have often made them with a mix'd Metal, of half Pewter, and half Spelter, which perform very well, and are easily made; because this Metal will melt, almost as soon as Lead, in a Fire-shovel, to be cast in a Mould; but Brass will not melt without a Crucible.

The first Idea that I form'd of this Machine, was thus: I imagin'd the Mortise, or Groove, brought from the Sound-board of an Organ, together with the Tongue and Spring, all of them much alter'd; the Mortise having an Hole therein, and put on upon one of the Iron Gudgeons of the Wheelbarrow; which Gudgeon being enlarg'd to an Inch and an half Diameter, having on it the Notches of the Cylinder of a Cyder-mill, on that Part of it which should be within the Mortise, and this Mortise made in the Ear of the Wheelbarrow (thro' which the Gudgeon usually passes), made broad enough for the Purpose; this I hoped, for any thing I saw to the contrary, might perform this Work of Drilling; and herein I was not deceived.

As for placing a Box over this Mortise to carry a sufficient Quantity of Seed, it was a thing so obvious, that it occasion'd very little Thought; and an Instrument for making the Channels, not much more; neither for applying Two Wheels, one at each End of the Axis, instead of the single Wheel in the Middle of the Axis of the Wheelbarrow.

At first my Plough made open Channels, and was very rude, being compos'd of Four rough Pieces of Planks, of little Value, held together by Three Shoots, or Pieces of Wood, which held them at a Foot Distance

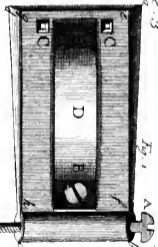
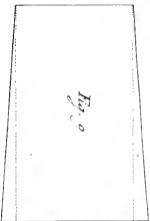
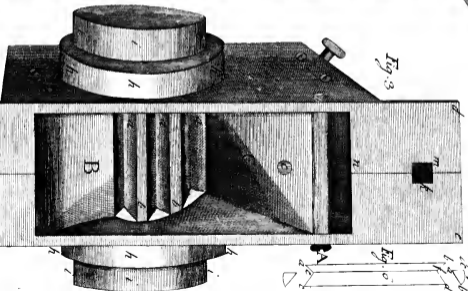
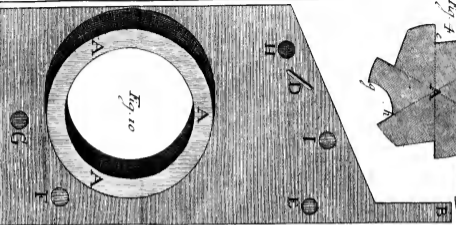
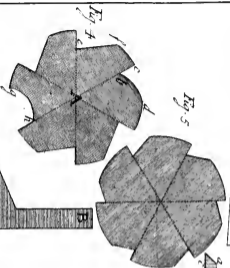
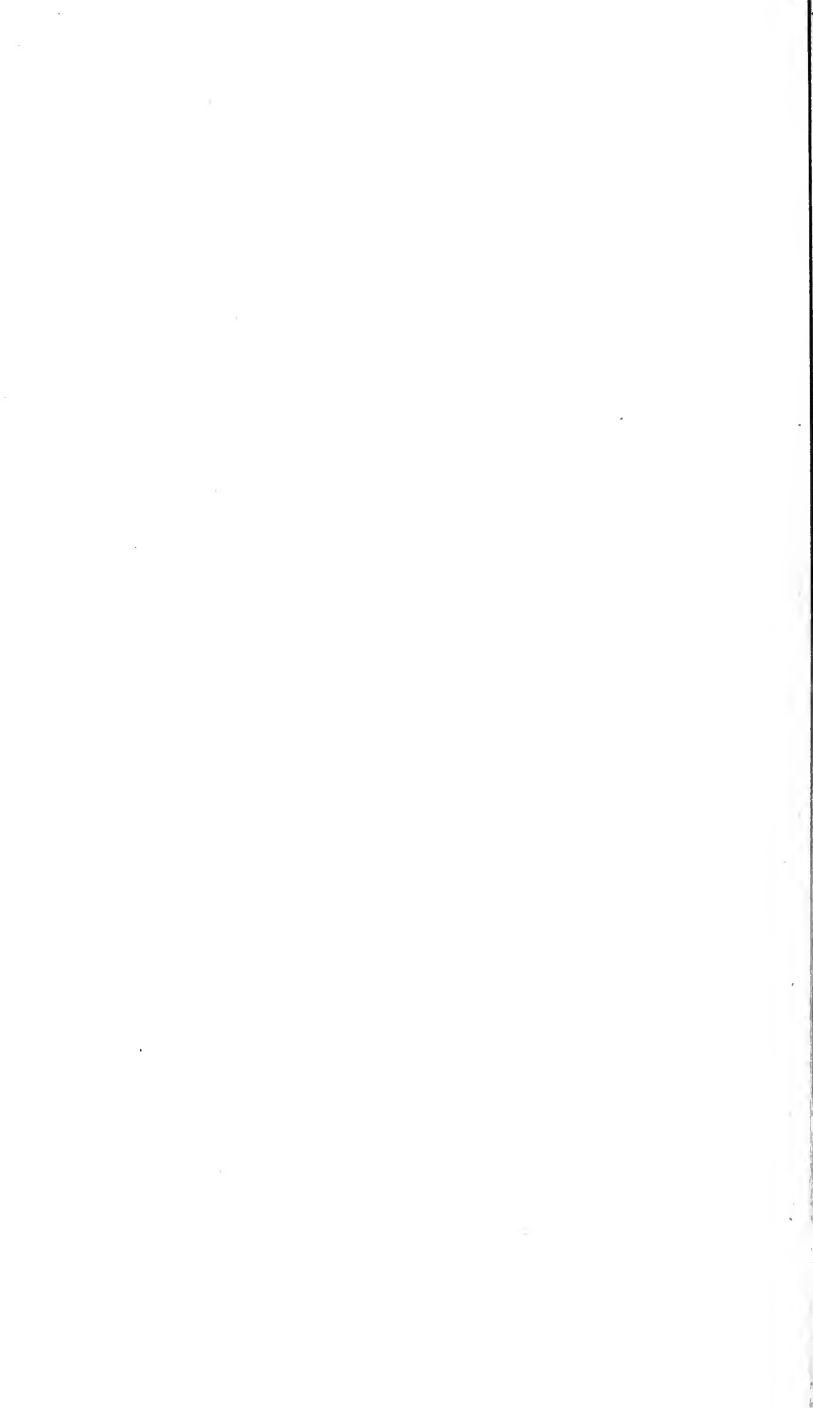

Fig. 7



W. H. W. W. W. W. W.



stance one from the other: These Pieces, being cut sharp at Bottom, made the Channels tolerably well in fine Ground. But I soon contrived a Plough with Four Iron Shares, to make Channels in any Ground: This drew a Hopper after it, having Four Seed-boxes at its Bottom, carried on a Spindle by Two low Wheels, which had Liberty to rise and sink by the Clods that they pass'd over: The Seed-boxes delivered their Seed immediately into the open Channels.

This Plough and Hopper were drawn by an Horse, and the Seed, lying open in the Channels, was covered sometimes by a very light Harrow, and sometimes by an Huddle stuck with Bushes underneath it.

I soon improv'd this Plough to perform better, and to make Six Channels at once, and sometimes a great many more.

This Plough and Hopper, with their Improvements and Alterations, are shewn in *Plates 4. and 5.*

C H A P. XXI.

Of the Wheat-Drill.

FIG. 1. in *Plate 4.* is the Drill-plough, which makes the Channels for a treble Row of Wheat, at Seven-inch Partitions, and covers the Seed by the Harrow which moves on its Beams. A, is the Plank, Three Feet and an half long, Eight Inches and an half broad, one Inch and a quarter thick; its upper and under Surfaces are true Planes. B, B, the Two Beams, each Two Feet Four Inches long, Two Inches Three quarters broad, and Two Inches and a quarter deep, standing under the Plank at right Angles with it, and held up to it by the Four Screws and Nuts *a, a, a, a,* the one being at the same Distance from
the

the right, as the other is from the left End of the Plank.

This Plough makes its Channels by Three Sheats, and their Shares and Trunks; the First or Foremost of which Sheats stands under the Middle of the Plank, with Part of it appearing at *b*; and is fully describ'd in *Fig. 2*, where *A* is the Tenon, of a convenient Size, Two Inches broad between Shoulder and Shoulder, Three quarters of an Inch thick: It is driven into the Plank thro' a Mortise, and pinn'd up by its Hole: It stands thus obliquely, and pointing forwards, that it may stand the more out of the Way of the Funnel. The Shoulder at *a* is a quarter of an Inch. The hinder Shoulder, from the Tenon to the Angle at *b*, is Three quarters of an Inch. The Depth of the Back of the Sheat, and Thickness of the Share, when it is on, from *b* to *c*, is Nine Inches and a quarter; and the Angle at *c* must be a right Angle, contrary to the Opinion of some, who fancy it ought to be acute, supposing that when this Angle is right, whilst the Seed is descending by the Back of the Sheat, the Plough, as it moves forwards, would get before the Seed, and so it might fall to the Ground behind the Trunk; but this Mistake is for want of considering the vast Disproportion between the Celerity of the Seed's descending near the Earth, and the slow Progress of the Plough; the Seed descending at the Rate of Sixteen Feet in a Second of Time, and the Plough proceeding but about Three Miles an Hour, does not advance the Thickness of a Seed, whilst it is falling to the Ground by the whole Depth of the Sheat.

The Thickness of the Sheat is an Inch, at its upper Part. The rest of it is to be no thicker than the Breadth of the Share.

Fig. 3. is the Share, lying Bottom upwards. *a* is its Point. *b* the Socket, Three Inches long, Seven Sixteenths of an Inch broad. *c* is the Hole, by which it is fastened up to the Sheat. *d* is another Hole, which is never made use of, except when the Share, being

being fasten'd up by the other Hole, inclines to either Side; then we draw it right by a Nail driven into this Hole. *e, e,* are Two very small Notches, into which the Sides of the Trunk are jointed, to protect them from being torn out by the Earth or Stones that might rub against them. *f* is the Tail of the Share, which, when it is in its Place, will make the right Angle before described in *Fig. 2.* and from which Tail, to the Fore-part of the Socket, is the Length of the Bottom of the Sheat, *viz.* Six Inches and an half. The Breadth of the Share Three quarters of an Inch.

Fig. 4. shews one Side of the Share. The prick'd Line *a e* shews the Bevel of the Fore-end of the Socket, the upper Edge of which must bear upon the Fore-part of the Sheat below *f* in *Fig. 2.* and the other Part of the Share will bear against the Bottom of the Sheat, from *d* to *c*, and will be fastened up by a flat Nail, passing thro' the foremost Hole of the Share, and entering the Hole *g* in the Sheat; which Nail being bended in the said Hole (which Hole should be at least an Inch Diameter) will hold the Share fast to the Sheat; and, by unbending this Nail, the Share may be easily taken off, upon Occasion, without damaging the Sheat. *Note,* This Hole in the Share ought to be wider below than above, and the Head of the Nail of the same Shape; or else, as the Share wears thinner, it might come off. The prick'd Line, near the Fore-part of the Sheat, shews where a Shoulder must be cut on each Side of it, because otherwise the Sheat, being thicker than the Breadth of the Socket of the Share, could not enter it: But take care, that the Share do not bear against these Shoulders.

Fig. 5. is one Side of the Trunk, being a thin Plate of Iron, and is often made of the Blade of an old Scythe: It is to be riveted on to one Side of the Sheat, to another of the same on the opposite Side, by Three Rivets passing thro' them both, with the Sheat in the Middle of them; which Holes appear
both

both in the Plate and in the Sheat. These thus riveted on do form the Trunk at the Back of the Sheat. The whole Breadth of this Plate is an Inch and Three quarters; but Three-eighths of an Inch being riveted on to the Sheat, there remains but an Inch and Three-eighths for the Trunk. The Length of the Plate is the same with the Depth of the Sheat and Share, except that it should not reach to the Bottom of the Share, by about the Thickness of a Barley-corn, to the end that it may not bear against the Ground, as the Share doth. The Notch at the Bottom of the Plate is that which answers the Notch in the Tail of the Share: The Corner of the Plate at *a* we make a little roundish, that it may not wear against the Ground.

This Plate thus riveted on the Sheat, and another of the same Form on the other Side opposite to it, compose the Trunk, which is *Fig. 6.* *a d* is the Edge *a b* of the Plate *Fig. 5.* *b c* is the like Edge of the opposite Side of the Trunk. *A* is the Back of the Sheat, which, together with the Tail of the Share when in its Place, makes the Fore-part or Length of the Trunk. The Thickness of this Back of the Sheat is the Width of the Trunk; and from this Back of the Sheat to the said Edges of the Plates, may be call'd the Depth of the Trunk. The upper Ends of these Two Plates *a* and *b* we spread open a quarter of an Inch wider, for half an Inch down, than the rest of the Trunk, for the more free Reception of the Seed from the Hole of the Funnel: We likewise take care, that the Two lower hinder Concerns of the Trunk do not incline to one another, to make the Trunk narrower than the Back of the Sheat, lest the Earth should be held in by them, and fill the Bottom of the Trunk.

Fig. 7. is one of the hinder Sheats, and appears, in part, at *c* in *Fig. 1.* It is fastened into one of the Beams by its Tenon, which, being driven into a Mortise, is pinn'd in by a Pin passing thro' the Beam, and the

the Tenon cut off even with the upper Surface of the Beam: This Tenon stands more oblique than that of the fore Sheat, that there may be the more Wood between its Mortise and the Funnel, its hinder Shoulder being short: Its fore Shoulder at *a* must be very short, not above the Eighth of an Inch; but its Shoulder *b* Three quarters of an Inch. The Tenon is also shoulder'd on each Side, as well as before and behind. The Thickness of this Sheat should be greater than that of the Fore-sheat, because it is much narrower. The Depth of this Sheat, is less than the Fore-sheat, by the Depth of the Beam: It is, in all other respects, the same with the Fore-sheat, except that it and its Share are shorter. The Socket of this Share is but an Inch and One-eighth long, its Breadth half an Inch, and from the Fore-part of the Bottom of the Socket to the End of its Tail, but three Inches. Its Point from the Socket at Bottom is but Three quarters of an Inch, whereas the Point of the Fore-share is an Inch and Three quarters: There is but one Hole whereby the Share is fastened up to the Sheat. Its Trunk is no wider than the other; for we cut a Rabbit on each Side of the Sheat, that the Plates, which are the Sides of the Trunk, may come within Three quarters of an Inch of one another. Its Tenon, being narrower than the Tenon of the Fore-sheat, must be thicker than it.

The other Hinder-sheat, and all its Accoutrements, must be the same as this of *Fig. 7.*

The Workman must take care, that the Tenons of the Sheats be not made cross the Grain of the Wood; and therefore must make them of crooked Timber.

Fig. 8. shews how the Share is made of Four Pieces; of which *a* is a Piece of Steel for the Point, its larger End being cut bevel for the Shape of the Fore-end of the Socket. *b* is a Piece of Iron for the other End of the Share, from the Socket to the Tail: The other Two Pieces *c* and *d* are the Iron Sides, which, being
welded

welded on to the other Two Pieces, and cut off to the Length, form the Share, with its Socket, more exact than it can be made out of one Piece of Iron.

Now we return to the first Figure; where the Fore-sheat being fix'd up at equal Distance from each End of the Plank, and as near to the hinder Edges of it as can be, allowing room for the Funnel C to stand with the Fore-side of its Hole, to make one Surface with the Back of the Sheat, and for the hinder Part of the Trunk not to reach the Edge of the Plank, there must be also room for the Fore-standard D to stand perpendicular to the Plank, across the Tenon of the Sheat.

This Standard being close to the Fore-side of the fore Hopper, there must be so much room between it and the Hole of the Funnel, that the Seed may drop from the Seed-box into the Middle of this Hole. Thus much for placing the Fore-sheat.

Next, for the Two hinder Sheats; they must be placed at equal Distance from the Sides of the Beams, and so near to the hinder Ends of the Beams, that there may be room to make the Funnels in them, and their Tenons to come up between their respective Funnels E and F, and their respective Standards G and H, which Standards must be set perpendicular to the Beams.

The Distance of these Sheats from the Plank must be such, that the Wheels of the hinder Hopper may not strike against the Plank, nor against the Spindle of the fore Hopper; and the Semidiameters of these Wheels being Eleven Inches, there ought to be a Foot between the Centre of each Wheel and the Plank; but we sometimes cut Notches in the Plank, to prevent the Circle of the Wheels from coming too near the Plank.

For the nearer the hinder Sheats stand to the Plank, the better; but these Beams may be placed nearer to, or farther from the Plank, by their Screws and Nuts, at Pleasure.

These

These Beams must be set at such a Distance from one another, that the Shares may be Fifteen Inches asunder from the Inside of one to the Outside of the other.

To try whether all these Sheats and Shares are truly placed, set the Plough upon a level Surface; and then, if they be right, the Fore-share will touch the Surface by its Point and Tail, and likewise the hinder Sheats will do the same; except that some Workmen will have it, that the Plough goes better, when the Tails of the hinder Sheats are a Barley-corn's Thickness higher than their Points; and then their Tails will want so much of touching the Surface.

The Shares must be all of them parallel to the Beams, and consequently to one another.

The Chanel made by the fore Share and Sheat for the middle Row, being at equal Distance between the Two hinder Sheats, is cover'd by them, they raising the Mould over the Seed from each Side of this Chanel.

The Harrow I is drawn by the Beams, to which it is fastened to their Insides at *d* and *e*, having each a small Iron Pin, passing thro' each End of the Legs of the Harrow, and thro' the Beams; each having a Nut on the Outsides of the Beams, and being square in the Beams, that they may not turn therein to loosen their Nuts; but are round near their Heads, that the Harrow may easily move thereon.

The round Ends of the Legs of the Harrow are put thro' its Head I, at the round Holes *f* and *g*; and pinned in behind it, to the end that either Tine of the Harrow may descend at the same time that the other rises, where the Ground is uneven.

The Two wooden Tines K and L are pinned in above the Head, and have each of them a Shoulder underneath. They stand sloping; so that if they take hold of any Clods, they do not drive them before them, but rise over them. They are of a convenient
Length,

Length, to give room for the Harrow to sink and rise, without raising up the Shares; and to give them the more room to move: The Legs of the Harrow are crook'd downwards in the Middle.

The Distance of these Tines from each other is Twenty-two Inches; so that each Tine going Three Inches and an half on the Outside of each Chanel that is next it, fills it up with Earth upon the Seed, from the Outsides of it; which causes the Rows to come up something nearer the inner Sides of the Channels, than to the outer Sides, from whence the Earth is brought into them by the Tines; and the Two outer Rows by this means come up at Fourteen Inches asunder, tho' the Channels were Fifteen Inches asunder.

This way of covering adds more Mould to the Top of a Ridge; whereas, if the Channels were covered by Tines going within or between them, the Mould would be thrown down from the Top of the Ridge: And these Tines stand with their Edges and Points inclining outwards, by which means they bring in the more Earth to the Channels.

If we find, that the Harrow is too light, we tie a Stone upon it, to make it heavier; and sometimes we fix a small Box of Board on the Middle of it, to hold Clods of Earth for that Purpose.

The fore Funnel C has its upper Edges Two Inches high above the Surface of the Plank. It is Five Inches Square at Top; its Four opposite Sides being Planes equally inclin'd to each other downwards, until they end at the Hole in the Bottom of the Funnel, which Hole is continued quite thro' the Plank into the Trunk. The Shape of this Hole is shewn in *Fig. 9.* where the Four Lines *a b*, *b c*, *c d*, and *d a*, each Line being Three quarters of an Inch, make a true Square, and are the upper Edges of the Hole. The Three prick'd Lines *e f*, *f g*, and *g h*, being each of them longer than the former, tho' as little as possible, make the Three lower Edges of the Hole; which be-
ing

ing thus wider below than above, and having all its Sides true Planes and smooth, it is impossible for the Seed to arch therein. The fore Side of this Hole is perpendicular to the upper and lower Surfaces of the Plank, and, together with the Back of the Shear, makes one Plane Surface.

When we drill a large Species of Seed, as Peas or Oats, we can make this Hole a full Inch square at Top, and of the same Shape wider at Bottom; which tho' it be wider than the Trunk, except at its Top, the Seed will not arch there, because there is room behind, the Plates being broader than the Sides of the Hole; for there can be no Arching in the Trunk, unless the Seed were confin'd behind as well as on each Side.

The Holes of our Funnels ought to be of the same Shape with this described; tho', as I am inform'd, the Pretenders to the making of this Plough make the Holes of their Funnels the Reverse of this; which being wrong-way upwards, the Seed is apt to arch in them, except the Holes are very large.

Of this Plough, *Fig. 1.* the Two hinder Funnels E and F differ from the fore Funnel (which has been described), first, in Dimensions; these not being so deep, because they being made in the very Beams, their upper Edges are in the upper Surface of the Beams, and their Holes at the Bottom, being about the Eighth of an Inch deep. The Depth of the Funnels must want the Eighth of an Inch of the Thickness of the Beams; but we make each Funnel an Inch and a quarter broader at Top than its Beam, by adding a Piece of Wood to each Side of its Beam, which reaches down about half-way its Thickness; and these Pieces being firmly fix'd on by Nails, to the Sides of each Beam, the Legs of the Harrow take hold of these Pieces, which are in the Inside of these Beams. When the Plough is taken up to be turn'd, the Man who turns it takes hold of the

Head of the Harrow with one Hand, and lays the other upon the Hopper, or Spindle, to keep it level, and to prevent either of the fore Wheels from striking against the Ground, whilst the Plough is turning round.

Another Difference there is between the Shape of these hinder Funnels from that of the former, to wit, That each fore Side of the hinder Trunks must not be quite so oblique as the rest; because then the upper Edge of these fore Sides might be too near the Tenons of the Sheats, and there might not be sufficient Wood betwixt them, to prevent the Sheats from being torn out; a thing which has never happen'd, that I know of. We sometimes make these hinder Funnels of a roundish Shape, like a Cone inverted; except that the Part which is next the Sheat, is not so oblique as the rest, for the Reason already given.

The only Advantage propos'd by this roundish Shape is, that there is less Wood taken out than from the square Corners, and therefore more Wood for the added Pieces to be fastened to the Beams, than in the square Funnels.

M and N are Two Pieces of Wood, each Eleven Inches long, Two Inches broad, and Two Inches thick: These are screw'd on near each End of the Plank, by Two Screws and Nuts each: They stand parallel to the other Beams, and have each a double Standard or Fork, O and P, in them, perpendicular to the Plank; by which Standards the fore Hopper is drawn and guided, in the manner as is seen in *Fig. 21.*

These Standards ought to be braced (or spurr'd) before and behind, and on their Outsides; they never being press'd inwards, have no occasion of Braces there: These are to be so placed, that when the Spindle is in their Forks, it may be exactly over the Hole of the Funnel, so that the Seed may drop into the Middle of it, when the Plough stands upon an horizontal Surface,

Surface, the Spindle being also exactly parallel to the fore Edge of the Plank.

Fig. 10. is D in the Plough *Fig. 1.* It is Two Feet long, Two Inches broad in its narrowest Part, and half an Inch thick in the thinnest Part, and Two Inches at its Shoulders above the Plank. It is pinn'd thro' the Plank before the Funnel, having one of its Legs on each Side the Tenon of the Sheat: It stands perpendicular to the Plank: Its only Use is to hold the fore Hopper from turning upon the Spindle, being put thro' a thing (*Fig. 22.*) like the Carrier of a Latch, nail'd on to the upper Part of the fore Side of the fore Hopper, in which thing this Standard has room to play, or move side-ways, to the end that either Wheel may rise up.

Fig. 11. is one of the hinder Standards, which being placed in the Beam, as G or H, perpendicular to it, is driven into a Mortise, and pinn'd into the Beam. It has a Shoulder behind, and another before, and a Third on its Outside; which Shoulders serve instead of Braces, to keep it from moving backwards, forwards, or outwards: It is Two Feet Four Inches long, Two Inches broad, and an Inch thick: It is placed with its broad or flat Sides towards the Sides of the Beams. It is made so thin, because it should have the more room for the Hopper to play on it; and therefore must have its Strength in its Breadth. The Part at *a* must stand foremost.

The Standards G and H are both alike, except as they are opposite: Their Use is to draw, guide, and hold up the hinder Hopper: They are to be placed perpendicular to the Beams, and at equal Distance from each Side of those Beams, and at such a Distance before the Funnels, that when the fore Side of the Hopper by its whole Length bears against the hinder Surface of the Standards, the Seed may drop into the Middle of both Funnels, the Plough standing upon an horizontal Surface.

Be sure to take care, that the Sheats, Funnels, and Standards, be so placed, that the Spindle of the Hopper may be at right Angles with the Beams.

Q and R Part of the Limbers, which are also called Shafts, Sharps, and Thills; from whence the Horse that goes in them is call'd a Thiller. These Limbers are screw'd down to the Plank, by Two Screws and Nuts each. The Limbers are kept at their due Distance by the Bar S; near each End of which Bar, there is a Staple with a Crook underneath each Limber, to which is hitch'd, or fastened, a Link of each Trace, for drawing the Plough. This Bar is parallel to the Plank, and Seven Inches and an half before its fore Edge.

The Limbers must be mounted higher or lower at their fore Ends, according to the Height of the Horse that draws in them; and this may be done by the Screws that hold them to the Plank, and by cutting away the Wood at the Two hinder Screws, or at the Two foremost Screws, or by Wedges.

Every Workman knows how to team the Limbers; that is, to place them so on the Plank, that the Path of the Horse, which goes in the Middle betwixt them, may be parallel to all the Shares, and so that a Line, drawn in the Middle of this Path, might fall into a strait Line with the fore Share, standing on the same even Surface with the Path; for otherwise the Plough will not follow directly after the Horse, but will incline to one Side.

The Use of the Trunks of this Plough is for making the Channels narrow, of whatsoever Depth they are: But, without Trunks, the Channels must be made wide by Ground-wrists, which spread the Sides of the Channels wide asunder, to the end that they may lie open for receiving of the Seed; and the deeper they are, the wider they must be: By this Width of a Channel, the Seed in it is with more Difficulty cover'd, and the Channel fill'd with the largest Clods, and the
Seed

Seed comes up of a great Breadth, perhaps Three or Four Inches wide, so that the Weeds coming therein are hard to be gotten out.

To avoid these Inconveniences of wide Chaneis, I contrived Trunks like those described, except that they were but Five or Six Inches high; and the Tops of their Plates, bending outwards from each other, form'd Two Sides of a Funnel; and the Wood between the Two Plates, being cut bevel at the Top, was as the fore Side of a Funnel to this Trunk: It was open behind from Top to Bottom: The Wheels were low, and the Seed-boxes narrow: The Seed in these Chaneis was easily cover'd, especially those Sorts which were sown in dry Weather; for then the finest Mould would run in, and cover the Seed, as soon as the Trunks were past it.

The Seed in such a narrow Chanel comes up in a Line, where the Row not being above a Quarter of an Inch broad, scarce any Weeds come in it; and when the Weather is dry, the Earth of the Chanel not lying open to be dry'd, the Seed comes up the sooner.

I had Two Reasons for making of these Trunks higher, as they are now used: The one was, to avoid the too great Length of the Shares; and my other Reason was, that with those low Trunks, and long Shares, there could not be Two Ranks of Shares, and their Hoppers in the Plough, which are necessary for making very narrow Partitions, and absolutely necessary for planting this treble Row of Wheat; for if Three Shares for making the Seven-inch Partitions were placed in one Rank, the Mould (which is always moist or wet, when we plant Wheat) would be driven before the Shares, there not being room for it to pass betwixt them.

Fig. 12. is one End of the hinder Hopper laid open. I call it one End (altho' it be an intire Box by itself) because this Hopper is supposed to have its middle Part cut out, to have a clearer Sight of the

Plough, and fore Hopper; as is seen in *Fig. 15.* which is the whole Hopper in Two Parts. In this *Fig. 12,* A is the Inside of one End of the Hopper, made with several Pieces of half-inch Elm-board nail'd on to the Post *c a,* on the fore Side; which Post is a little more than half an Inch square, and Seventeen Inches and Three quarters long, being the Depth of that Part of the Hopper which holds the Seed. B is the fore Side of this Hopper; which must be nail'd on to the said Post, being of the same Length with it, and Four Inches broad, and half an Inch thick; and this is the Part which on its Outside goes against the right-hand Standard of the Plough, when it is at Work. The other Post *b d,* of the same Thickness with the former, is nail'd in within half an Inch of the opposite Edge of this End; to which Post also C being nail'd, makes the hinder Side of this Part of the Hopper. C is Four Inches broad, and half an Inch thick; and both it, and the Post to which it is to be nail'd, are something longer than its opposite Side, because the Side B makes right Angles with the Top and Bottom of the Hopper; but the hinder Side C makes oblique Angles with the Top and Bottom of the Hopper; and the Reason of this is, because when the Hopper is full of Seed, it may be equally pois'd on the Spindle; which it could not be without this Bevel, unless the Bottom of the Hopper did come as much behind the Spindle as before it; and that would hinder the Person that follows the Drill, from seeing the Seed fall out of the Seed-box into the Funnel; and that Part of the Bottom which is before the Spindle cannot be made shorter, because that Part of the Seed-box which is before the Spindle, is (upon account of its Tongue) much longer than the Part of it which is behind the Spindle. 'Tis true that when the Hopper is empty of Seed, it cannot be thus pois'd; but then, being so light, it does not require it. *e f g b* is a Piece of a Board, nail'd on to that Part of the End

A, which is below the Bottom of the Cavity which holds the Seed, and is commonly plac'd a little cross the Grain of the Board to which it is nail'd, and serves to strengthen it, and keeps the Hole *i* from splitting. The upper Edge *e f* of this added Piece of Board is exactly the Length of the Bottom of the Hopper, whereto the Brass Seed-box is fastened; and this Bottom, together with its Seed-box under it, being put into its Place, bears upon this Piece from *e* to *f*, which holds up the right Side of the Bottom, and keeps it from sinking downwards; as the lower Ends of the Two mention'd Posts, and the fore and hinder Side B and C nail'd to them, prevent its rising upwards.

The Manner of making the Hole *i* is as follows: Place the Seed-box with its fore End at *e*, and hinder End at *f*, with the Base of its Cylinder (or great Hole) against this added Piece of Board, and its upper Edge exactly the Height of the Edge *e f*; then, with a Pair of Compasses put thro' the Cylinder of the Seed-box, mark round the inner Edge of its Base upon the added Board; then take off the Seed-box, and find the Centre of the mark'd Circle; and then with a Tool call'd a Centre-bit, of the right Size, bore the Hole quite thro' the double Board; and this Hole will be in the right Place, and of the same Diameter with the Spindle; but in case there is to be a Brass Wreath on that Part of the Spindle which is to turn in this Hole, then the Hole must be bor'd of the same Diameter with that Part of the Wreath which is to enter it; and that may be perhaps near a quarter of an Inch longer than the Diameter of the Spindle, upon which it is fastened.

This End A, thus bor'd and shap'd, is a Pattern for its Opposite, and for the other Two Opposites of the other Cavity, which holds the Seed at the other End of the Hopper.

When the Opposite of A (with the Two Posts whereto the fore Side B, and the hinder Side C, are nail'd, and having a like Piece of Board in its lower Part with a like Hole in it) is added, and when the Bottom (Four Inches broad), with its Seed-box under it, is thrust in at *f* by the prick'd Lines, until it reach *e*, bearing on one Side upon the Piece of Board *efgb*, and the other Edge of the Bottom bearing in like manner upon the opposite Piece, then this Cavity of the Hopper, which will contain about Two Gallons of Seeds, will be finish'd.

Note, The Bottom must make a right Angle with the Two fore Posts, having the Side B perpendicular to it.

D is a Part of the Board which comes out farther than the Hopper, in order to hold a Bar at *k*; which being fastened there, and in like manner to the Opposite of this Board, this Bar bearing against the fore Part of the Standard, the Hopper and its Wheels are in part drawn by it.

Into the Notch *l* is fastened one End of a long Bar, which passes the whole Length of the Hopper, and holds the upper Part of its Two Cavities in their Places, as is seen mark'd D, in *Fig. 15*.

E is Part of the Board which comes before the Hopper, and whereto one End of a Piece of Wood is fastened by Nails or Screws, which bearing against the fore Part of the Standard, and against its Inside, the Hopper is in part drawn and guided by it, as shall be shewn in *Fig. 15*.

Fig. 13. shews the Outside of the Figure last describ'd. A is the Standard by which this End of the Hopper is drawn, in the manner as it is here placed. B is one End of the Spindle passing thro' the Hopper and Seed-box. C the Bottom, having the Seed-box fastened on to it, with one Screw before, and another behind, with their Nuts underneath, and the Heads of their Screws very thin, and the Pins square at
Top,

Top, that they may not turn in the Wood; and their Heads must either be let into the Wood, even with the Surface, or else the Sides B C of the Hopper must be cut for these Heads of the Screws to pass in under them.

This bottom Board, which holds the brass Seed-box, is Four Inches broad, and full half an Inch thick, and at each End a quarter of an Inch longer than the Seed-box: This Piece is first thrust in sliding upon the Two added Pieces of Board, until its fore End comes under the fore Side of the Hopper, and its hinder End under the hinder Side; then setting the Hopper with its Bottom upwards, the Spindle being thro' the Seed-box, and Holes of the Hopper, we hold the Seed-box hard upon the Bottom, at equal Distance from each End of it, whilst the Holes are bored thro' the Bottom, by the Holes at each End of the Seed-box; and then the Screws, being put thro', screw on the Box; and when that is done, we make a Mark upon the bottom Board, with the Compasses, on each Side of the Brass Box, beginning from the Ends of the Axis of the Tongue, reaching as far backwards as is the Length of the Mortise: These Two Lines or Marks are a Direction for cutting the Hole in the Bottom of the Hopper, thro' which the Seed descends into the Seed-box; then we pull out the Spindle, then draw out the Bottom, take off the Seed-box, and cut the Hole in the Bottom in the manner I will now describe in *Fig. 14.* where the Two pricked Lines *a b* and *c d* are the lower Edges of the Hole, and the same with the Two Lines mentioned to be marked by the Sides of the Seed-box. The pricked Line *a d*, being at right Angles with the Two former, is the lower Edge of the fore End of the Hole, and exactly over the Axis of the Tongue, and parallel to it. The pricked Line *b c* is the lower Edge of the hinder End of the Hole, which is just over the hinder End of the Mortise, and parallel and equal to

to the last-mentioned pricked Line: These Four pricked Lines are the lower Edges of this Hole, contiguous to the Seed-box. The Two Lines *e f* and *g b* are the upper Edges of the Sides of the Hole, which, being farther asunder than the lower Edges, make the reverse Bevel of this Hole; which may be determined by this, that the Surface between these Two upper and lower Edges, being Planes, are inclined to one another downwards, in an Angle of about One hundred and Thirty Degrees. The Two Lines *e b* and *f g*, at right Angles with the Two last-mentioned Lines, make the upper Edges of the Ends of this Hole; and, being nearer together, than the pricked Lines under them, the plane Surfaces, betwixt these Two Lines and those Two pricked Lines, shew the Bevel of the Ends of these, which are inclined to each other upwards in an Angle of about Sixty-five Degrees.

This double Bevel effectually prevents the Seed from arching in the Hole, before it gets into the Mortise of the Seed-box; and also, the Two upper Edges of the Ends of the Hole being nearer together than the lower, there is the more Wood left between these Edges and the Screws, which hold the Box to the Bottom, whereby the Board is less apt to split.

Then the Box being screwed on to the Bottom, and thrust again into its Place, the Spindle, passing thro' both the Hopper and the Box, keeps the Bottom in its Place: Then *D*, in *Fig. 13.* is the imaginary Plane of the Top or Mouth of the Hopper, being a rectangular Parallelogram, and parallel to the Bottom, to which the fore End is perpendicular, and a rectangular Parallelogram of the same Breadth.

Fig. 15. shews the fore Side of the whole hinder Hopper, with its Two Cavities, and all its Accoutrements, except the Wheels; the Two Ends *A* and *B* being exactly alike, having each of them its Seed-box at the Bottom, in the same manner as in the one has been described. The Bar *D* holds together the upper
Parts

Parts of this double Hopper at a right Distance, which is, when there is Ten Inches clear room betwixt the Two single ones. The Spindle E, passing thro' the Whole, holds the Two single Hoppers by Four Wreaths, at the same Distance below, as they are held by the Bar above.

These Four Wreaths are screwed on to the Spindle, to keep it from moving towards either End, as well as to hold the Hoppers in their Places: Two of which Wreaths are seen at *a* and *b*; and the other Two are placed on the Outsides, as these Two are on the Insides. Before we proceed any farther in this Figure, it will be proper to shew the Wreaths, which are of Two Sorts.

The one in *Fig. 16.* where *A* is its Hollow, which is circular, and must be of the same Diameter with the Spindle; and, being thrust on upon the Spindle, till it touch the Board, is fastened to the Spindle by a small Screw thro' each of its opposite Holes. *a b* shews the Breadth of this Wreath, whether it be made of Brass or Wood: It is little more than half an Inch. *b c d* is the Part of it that goes against the Board: The Thickness of the Surface of this End which goes against the Board, is a quarter of an Inch, if made with Brass; but if with Wood, half an Inch; but the Thickness of its other End *a e f* is less than its End *b c d*, by which means the Screws are the more easily turned in.

Fig. 17. shews the other Sort of Wreath, which is always made in Brass: Its Cavity is a hollow Cylinder like the former: When it is on the Spindle, its End *a b c* is thrust into the Hole of the Board (made wider for the Purpose) until *d e f* come close to the Board, and stop it from entering any farther; then we screw it on to the Spindle by the Holes, as the other Sort of Wreath is described to be screwed.

This is the best Sort of Wreath; because it keeps the Spindle from wearing against the Edges of the
Hole,

Hole, and then the Spindle never has any Friction against the Wood in any Part of it ; but the other Sort are more easily made (especially of Wood), and the Spindle will last a great while in them; or if it be worn out, the Expence of Three-pence or Four-pence will purchase a new Spindle.

Now I must return to *Fig. 15.* where the Spindle E having its Four Wreaths fixt on it, we turn it round with our Hand, to see whether the Wreaths are put on true ; and when they are so, neither the Spindle, nor the Hoppers, can move end-ways : Tho' the Spindle be pretty hard to turn round, the Wheels will soon cause it to turn easily. Whilst the Spindle is in this Posture, we turn the Hopper Bottom upwards, and mark the Spindle for cutting the Notches in the manner before directed ; and then we take off the Spindle, and cut the Notches, and also cut each End of the Spindle square, up to a Shoulder at each End, so that the Wheels may come easily on without knocking or thrusting ; and then we return the Spindle to its Place, and put on the Wheels, pinning them on with each a long Nail, which being crooked at the Ends, prevent it from falling out, but may be very easily pulled out with the Claws of a Hammer ; but we must take care, that neither the square Ends of the Spindle, nor the square Holes in the Naves (or Hubs) of the Wheels (into which they enter), be taper ; for, if they are taper, the Wheels will be apt to work themselves off.

The Piece of Wood, *Fig. 18.* is that which goes over the Standard, and, being placed in the Hopper, as F. in *Fig. 15.* draws that Part of the Hopper by its Inside *a b* bearing against the fore Part of the Standard ; and that Part of it from *b* to *c*, being the Breadth of the Standard, bears against its inner Inside, to prevent the Hopper from going any farther towards that End. This Piece of Wood is fastened to the Boards of the Hopper, either by Screws or Nails :

This

This Piece, from *d* to *e*, must be of such a Thickness, that the Standard, bearing against its Inside *b c*, may be equidistant from each Board, to which this Piece is fastened. The Part, or fore Side of this Piece *f g*, must be the Length of the Distance between Board and Board, to which it is fastened; and that is exactly Four Inches. Its Thickness and Depth must be such as may make it strong enough for the Purposes intended.

The Piece marked *Fig. 19.* is the Opposite of the former, and to be placed in the same manner, and as it is seen marked *G* in *Fig. 15.* observing always, that the Part of it, which holds the Hopper from moving end-ways, must always be on the Inside of the Standard; for, if these Pieces should bear against the Outsides of the Standards, the Hopper could have no Play upon them, nor could either of the Wheels rise up without raising the Share (that was next to it) out of the Ground; but, being thus placed, either Wheel may rise without the other, and without raising the Share.

I say more of this, because it is a Point wherein young Workmen are apt to mistake.

Thus having shewn, in *Fig. 15.* how the Hopper is guided and drawn at the lower Part, I come next to shew how it is held and drawn at its upper Part; for which the Piece of Wood, *Fig. 20.* being a competent Breadth and Thickness, Four Inches long, is fixt in between the Boards with Nails or Screws; and is *H* in *Fig. 15.* The Standard passing up betwixt this and the fore Side of the Hopper, its fore Surface bearing against this Bar, and its hinder Surface against the Hopper; so that the Hopper may rise and sink easily upon the Standard at Top, being in the Middle on the fore Side of the Hopper; there will be an equal Distance of each Side, for either Wheel to rise, without the Standard striking against the Sides of the Hopper to hinder its rising. There is another Bar
equal

equal to this, and has the same Office, at the other End of the Hopper, marked I. Likewise the Bar D is of the same Use with these mentioned short Bars, and they help to strengthen one another.

When the Wheels are put on till they reach near to the Wreaths, they will stand with their Rings, or Circles, Two Feet Three Inches asunder.

We set them as near together as conveniently we can; because when they are too wide, they are apt to draw the Plough towards one Side of the Ridge; and sometimes, when the Ridge is high, the Hopper might bear upon the Funnels; and then the Wheels, being carried above the Ground, would not turn to bring out the Seed: And that these Wheels may come the nearer together, their Spokes are set almost perpendicular; so that the Wheels are not concave, as other Wheels are. This Hopper is shewn, put on upon its Standards, in its Place, in *Fig. 21.* where the mentioned Bar D, which holds the Hopper together at Top, is seen, as also the Four Wreaths, and likewise the hinder End of the Seed-boxes standing over the Funnels, with their Trunks underneath them. Here also the back Part of the fore Hopper is seen, with its Seed-box standing over the fore Funnel: Its Mouth also is seen at A; as also the Top of its fore Side held up by the thing (*Fig. 22.*) like the Carrier of a Latch, with the Nails in it, which fasten it to the Top of the fore Side of the Hopper, and give room for either of its Wheels to rise.

This fore Hopper may easily be described by the Figure of a Box, like the other already described, at its Ends, which are of the same Shape with the Inside of the Box, *Fig. 12.* but much lower, being Seven Inches and an half deep, and Sixteen Inches long; and the Breadth of its Bottom is determined by the Length of the Seed-box, and a little wider at Top, on account of the Bevel which poises it: It carries no more Seed than one End of the hinder Hopper; but

but it is capable of holding more; but we do not fill it quite, lest some of the Seed should fly over in jolting, its Mouth being so much longer than the other.

This Hopper is kept in its Place, from moving end-ways upon the Spindle, by a Wreath fixed to the Spindle at each End of the Box, in the same manner as has been described for holding the other Hopper. The Wreaths most proper for this Purpose are the Sort described in *Fig. 17.* but the other Sort described in *Fig. 16.* and even made with Wood, will suffice; but then we must take care to make the Hole at the End of the Hopper of a considerable Thickness, that it may not wear the Spindle, which, by reason of its great Length, is the more liable to bend, and be cut by the Edges of the Holes; which Cutting cannot be prevented but by the Thickness of the Holes, or by such Wreaths as that of *Fig. 17.*

We sometimes make this Hopper exactly like a common Box, without any Part of its Ends descending below the Bottom; and, in that Case, we place a narrower Piece of Board at each End of the Hopper, like that of *Fig. 23.* in which Figure, the Hole A being put on upon the Spindle, the Piece of Board is fastened on by a Screw and Nut thro' the Hole B, near the Top of the End of the Hopper, and by another Screw and Nut thro' the Hole C, near the Bottom of the Hopper. Another such a Piece of Board, fixed on in the same manner to the opposite End of the Hopper, holds this long Hopper parallel to its Spindle, that passes thro' the Holes of these Two Pieces, and thro' the Brass Seed-box, which is fixed up to the Bottom, in the Middle betwixt them.

There are Two Methods for letting the Seed pass from a long Hopper into the Seed-box. The first is that of cutting the Hole through its Bottom, in the manner that has been shewn in *Fig. 14.* The other is that which cannot be used in a Hopper so short as
the

the Boxes of our hinder Hoppers are ; but in the fore Hopper, or any other long Hopper, we can place the Brass Seed-box to a Bottom made for the Purpose, like that in *Fig. 24.* where there is a Piece of Board on the fore Part of the Hopper from End to End, as *a b*, and another on the hinder Part of the Hopper, as *c d*. Then the fore Part of the Brass Seed-box, being placed under the Piece *a b*, is screwed up to it at *e*, and the hinder Part of the Seed-box under *c d* screwed up to it at *f*; then the Bottom of the Hopper, being open in the Middle, is shut by very thin Boards, *g* and *h*, fixed up to the mentioned Pieces: These Boards having their upper Surface even with the upper Edges of the Brass Box, the Seed can no way arch in coming into the Mortise of the Seed-box. Whichever of these Two Methods be made use of, in a long Hopper, the Bottom must be fixed to the Two Sides, by small Bars of Wood of about Three quarters of an Inch square, to which the Bottom and Sides are fastened by Nails, in the manner that the Ends and Sides of the hinder Hoppers are fastened to their Posts, which stand in their Corners.

We take the same Method for cutting the Notches in this Spindle, as has been described for cutting the Notches in the other Spindle.

But observe, That the great Length of this Spindle requires it to be the larger ; and we make it of an Inch and Three quarters Diameter, the other being only an Inch and an half: We therefore bore the great Hole or Cylinder of its Brass Seed-box a quarter of an Inch in Diameter larger than of the Brass Seed-boxes of the hinder Hoppers ; and we commonly make a Notch more in the Circumference of this Spindle, because the Semidiameters of its Wheels must be as much greater than of the hinder Wheels, as is the Thickness of the Plank, and the Ends of the Limbers which are betwixt this Spindle and the upper Surface of the Two Beams.

We make all our Spindles of clear-quarter'd Ash, without Knots or Crooks; and when they are well dry'd, and made perfectly round, and of equal Diameter from one End to the other, by the Prong-maker, we pay a Penny *per* Foot for them at the first Hand, and they will now-and-then have something more for the largest Size; but we are only curious to have the middle Part of this long Spindle exact; for we graft on a Piece at each End, which does not require any Exactness: The Graftings are seen at *a a* at one End, and *b b* at the other End of the Spindle (in this *Fig. 21.*) by Four flattish Iron Rings driven on upon the grafted Parts, as they appear under those Letters in the Middle. Between each Pair of these Rings, we drive a small Iron Pin thro' the Joints at *c* and at *d*, to keep the Grafts from separating end-ways; and if they are not tight enough, we make them so, by Wedges driven in betwixt them and the Spindle.

This fore Hopper is drawn by the Spindle, and the Spindle is drawn by the Two double Standards B and C, betwixt whose Forks it is placed, as appears in this Figure; the Distance between each Fork, or double Standard, being exactly the Diameter of the Spindle, so that the Spindle may have just room to rise and sink there, and no more.

The Hopper and Spindle are guided, or kept in their Place, from moving end-ways, by Two Wreaths screw'd on to the Spindle, the one at *e*, and the other at *f*; each of which Wreaths, bearing against the Surfaces of both the Legs of each double Standard, on the Sides next to the Hopper, prevent the Spindle and Hopper from moving towards either End; and yet admit the Wheels, or either of them, to rise and sink without raising either Side of the Plough, contrary to what would happen, if the Wreaths were placed on the Outsides of the Standards next to the Wheels.

We make these Wreaths a little different from the other Sort of Wreaths, which turn against the Holes; we make them of a greater Diameter, lest they should at any time get in betwixt the Legs of the double Standards, in case the Standards should be loose, or bend: Therefore we make the Diameter of each of these Wreaths, at least, Two Inches and Three quarters: We always make them of Wood, and of a peculiar Shape, taking off their Edges next the Standards, which Edges would be an Impediment to the Rising of one End of the Spindle without the other. So that, for making these Wreaths, we may form a Piece of Wood of the Shape of a Skittle-bowl (or an oblate Spheroid) having an Inch and Three-quarter Hole bor'd thro' its Middle, and then cut by its Diameter (which is about Three Inches) in Two Halves, each of which will be one of these Wreaths; and they must be placed on the Spindle, with their convex Sides bearing against their respective Standards.

The Diameter of the fore Wheels is about Thirty Inches, as the Diameter of the hinder Wheels is about Twenty-two.

The fore Spindle should be of such a Length, that its square Ends, E and F, may come out Three or Four Inches farther than the Hubs (or Stocks) of the Wheels; so that there may be room to shift the Wheels towards either End, for making several Sets of Notches, for the Use of the Seed-box.

Observe, Tho' the fore Hopper is drawn by its Spindle, yet the hinder Spindle is drawn by its Hopper.

The Reason of this great Distance between the Two fore Wheels is not so much for their serving as Marking Wheels to this particular Drill; which being drawn only upon a Ridge, its Top is a sufficient Direction for leading the Horse to keep the Rows parallel to one another, if the Ridges are so; but if the Wheels were much nearer together than they are, and

yet more than Six Feet asunder, the Wheels going on the Sides of the next Ridges would be apt to turn the Drill out of the Horse-path towards one Side, not permitting the Drill to follow directly after the Horse; and if the Wheels should stand at Six or Seven Feet Distance from one another, then they must go in the Furrows which are on each Side of the Six-foot Ridge: This would occasion their Hopper to bear upon the Plank, which would carry the Wheels above the Ground, and no Seed would be turned out of the Hopper, unless the Wheels were of an extraordinary Height (*a*); and the Height requir'd for them would be very uncertain, some Furrows being much deeper than others; but the Tops of contiguous Ridges are generally of an equal Height, whether the Furrows betwixt them be deep or shallow; for we seldom make Ridges of an unequal Height in the same Field: Therefore there can be no need to change the Height of our Wheels, that are to go upon the Middle of the Ridges; but if they went in the Furrows they must be of a different Height

(*a*) Notwithstanding the Reasons given, and that I have never used Wheels of such an Height as might be necessary for going in the Furrows, yet it may not be amiss to try such; because with them the Spindle needeth not to be more than half the Length of one that is carried by low Wheels: And high Wheels will allow the Funnel to be much larger, so that altho' the Spindle go higher from it, no Seed will drop beside a large Funnel; but there is not room for a large one under low Wheels.

I did not think it necessary to describe the Manner of making Drill-wheels any otherways than by shewing them in the *Plates*; but I will observe here, that they are to be made very light: One of mine, that is 30 Inches high, weighs Five Pounds and an half; it has a Circle or Ring of Iron, whose Depth is half an Inch, and its Thickness a quarter of an Inch; also very thin Iron Stock-bands to hold the Nave or Stock from splitting. The Circle is held on the Spokes by small flat Iron Pins on each Side; and each Spoke has a Ring of Iron to secure its End from being split by driving in of the Pins. We also make the Drill-wheels less concave than other Wheels are.

when used for drilling of high Ridges, from what would be required when used for drilling low Ridges.

One Reason why the hinder Shares are shorter than the fore Share (and consequently the fore Part of their Sheats less oblique) is, that they may be set the nearer to the Plank; and I have had a Drill with Five Shares in the Plank, Fourteen Inches asunder, and Four of these hinder Sheats following in another Rank, whose Shares were less than Three Inches long; so that their Beams were set so far forwards, that one Hopper (by a Contrivance that carried the Seed forwards to the fore Rank, and backwards to the other Rank) supply'd the Seed to both Ranks of Trunks, and planted St. Foin in Rows Seven Inches asunder, when the Ground was too rough to be planted with Rows at that Distance by one Rank of Shares.

It may be objected, that the fore Part of these hinder Sheats might not be oblique enough to raise up the Strings of Roots or Stubble, which might come across them in their Way; but this Inconvenience is remedied by the greater Obliquity of the fore Sheat (or Sheats), which clears the Way for the hinder Sheats, by raising out of the Ground such Strings, &c. which might annoy them; especially, in this Wheat-drill, where the fore Share so clears the way of the hinder Shares, that they can take hold of no String in the Ground, except of the Ends of such which the fore Share has loosen'd; and they hanging faster in the Ground by their other Ends, the hinder Shares slip by them without taking hold of them; and the Harrow-tines, going after so near to the Channels of the hinder Sheats, by the same means escape also from hanging in such Strings.

The Reasons for placing the One Share and One Hopper before, and the Two behind, in this Wheat-drill, are so many, and so obvious, that it would be but losing of Time to mention them.

The Limbers G and H, we make of Aspen, Poplar, or Willow, for Lightness; we make them as small and light as we can, allowing them convenient Strength; and the shorter they are, the more exactly the Drill will follow the Horse, without the Hand of him, that follows the Drill, whose chief Business is, with the Paddle to keep all the Shares and Tines from being clogged up by the Dirt sticking to them, and also to observe whether the Seed be delivered equally and justly to all the Channels.

These Limbers should approach so near together at their fore Parts, near the Chain, that there may be none or very little room betwixt the Limbers and the Horse; and therefore must be nearer together for a very little Horse than for a great one: The Horse, which I have used in all my Drills for these many Years past, is a little one, about Thirteen Hands high; and the fore Part of my Drill-limbers are Twenty Inches wide asunder at the Chain.

At *g* on the Outside of the Limber G, is a small Staple driven in, having one Link on it, which holds a small Hook, which, taking hold of different Links of the very small Chain I, raises or sinks the fore Part of the Plough to different Heights. But take care to set it at such a Degree, that the fore and hinder Share may go equally deep in the Ground; and when they do so, the fore Part of the Limbers ought to be higher than the Traces which draw them.

At *b* in the Limber H, is driven another Staple, which holds the other End of the Chain; or else, instead of a Chain, we may make use of a Piece of Cord, one End of which put thro' this Staple, and ty'd to the Limber, and a Piece of Chain of half a dozen Links, fasten'd to the other End of such a Cord, will serve as well as a whole Chain, for raising and sinking the Limbers.

He who can by these Directions make this Wheat-drill, may very easily make any other Sort of Drill,

for planting any Sort of Corn, or other Seeds that are near about the Bigness of Seeds of Corn: He may make it with a single Row of Sheats, by placing as many of these fore Sheats as he pleases in the Plank, which may be longer or shorter, as he thinks fit; and he may add a Beam betwixt every Two of them, with a Sheat in it, like these hinder Sheats; and then the Drill will be double, having Two Ranks of Shares. But I must advise him never to make a Drill with more Shares than will be contain'd in Four Feet Breadth, that is, from the outermost on the right Hand, to the outermost on the left Hand; for should the Drill be broader, some of the Shares might pass over hollow Places of the Ground without reaching them, and then the Seed falling on the Ground would be uncover'd in such low Places.

To a Drill that plants upon the Level, Marking-wheels are necessary, to the End that every Row may be at its due Distance: As in a Drill with Five Shares, for planting Rows Eight Inches asunder, Four of the Five cannot err, because Four equal Spaces are included betwixt the Five Shares; but the Fifth (which we call the parting Space) being on the Outside unconfin'd, would scarce ever be equal, were it not kept equal by the Help of the Marking-wheels. The Rule for setting of these is thus: We compute altogether the Five Spaces belonging to the Five Rows; which being in all Forty Inches, we set the Marking-wheels Eighty Inches asunder, that is, double the Distance of all the Spaces, each Wheel being equidistant to the Middle of the Drill, which Middle being exactly over the Horse-path, when the Drill is turn'd, the Horse goes back upon the Track of one of these Wheels, making his Path exactly Forty Inches distant from his last Path: By this means also the Rows of the whole Field may be kept equidistant, and parallel to one another; so that it would be difficult for an Eye to distinguish the parting Rows from the rest.

But

But when Two different Sorts of Seed are planted, suppose a Row of St. Foin betwixt every Row of Barley, the Rows of which being Eight Inches asunder, and the Barley drill'd by the fore Hopper into the Channels made by the five Shares, and the St. Foin drill'd from the hinder Hopper into the Channels made by Six Shares, the Marking-wheels must be at no greater Distance than those above-mention'd, where there are only Five Shares; because one of the Six, which are for the St. Foin, must always return in the same Chanel, going twice therein; for One Row of Barley would be missing, in case the parting Space should be made by this Sixth Share; and that parting Space would have no Barley in it. Therefore it is a Rule, that whensoever Two Sorts of Seeds are drill'd, the Rows of one Sort betwixt the Rows of the other there must be an odd Share in the Drill, which must go twice in one Chanel, and the Distance of the Marking-wheels must be accounted from that Rank of Shares which are the fewest: It must also be contriv'd in this Case, that each outermost Seed-box must deliver but half the Quantity of Seed that each of the inner Seed-boxes do; because the outer ones going twice in a Place, their Channels would otherwise have a Quantity of Seed double to the rest.

In a Drill that has Two Spindles, we place the Marking-wheels on the foremost, which upon their Account is the longest; but if we should use the Wheels of the hinder Spindle as Marking-wheels, then that must be the longest, and so the fore Wheels (their Semidiameters being much longer than the Semidiameters of the hinder Wheels, and their Spindles shorter) would strike against the hinder Spindle, unless it were set farther back than is convenient.

When Ground is harrow'd the last time before it is to be drill'd, we contrive that the Harrows may not go directly towards the same Point that the Drill is to go, lest the Track of the Marking-wheel should

be exactly parallel with the Track of the Harrow-tines, which might make it difficult to distinguish the Track of the Wheel from that of the Harrow-tine.

He that has not a great Quantity of Ground to plant with St. Foin, and does not plant it betwixt Rows of Corn, will have occasion for no other Drill than this Wheat-drill, describ'd in *Fig. 21.* He may plant his Rows at Fifteen Inches asunder, by the hinder Hopper, and its Shares, without removing them, the fore Hopper being taken off; or else you may plant Three Rows at Sixteen Inches asunder, by setting the Beams, and their Seed-boxes and Hoppers, at Thirty-two Inches asunder instead of Fifteen, equidistant from the fore Share: and then the Marking-wheels, which are those of the fore Spindle, must be Eight Feet asunder; to wit, double to the Spaces of the Three Shares, which are Three times Sixteen Inches (or Four Feet); or you may set the Two hinder Beams, &c. at what Distance you please, setting the Marking-wheels to correspond with them; but then the Harrow must be alter'd, and both its Legs and Tines must change their Places in the Head, the Legs for guiding it exactly, and the Tines to follow in all the Three Rows, which will require a third Tine to be added in the Middle, between the other Two. But without any other Alteration than that of taking off the fore Hopper, and that of lessening the Seed-passages of the hinder Hopper by the Setting-screws; my Man planted me several Acres of St. Foin with my Wheat-drill Two Years ago, the Rows being all Fourteen Inches asunder: It is now an extraordinary good Crop.

In case the Shares, being only Three, should in fine Ground go so deep as to endanger the Burying of the Seed, the best Remedy to prevent this fatal Misfortune is, to place a triangular Piece of Wood, like those in *Figures 25.* and *26.* the first of which shews one Side thereof, with the Nail by which it is

to be nail'd into the lower Part of the Trunk, with its most acute Angle uppermost; the other in *Fig. 26.* shews the same, and its Back-side *a b*, that is to be nail'd to the Back of the Sheat, being of the same Breadth with it; its Bottom *b c* being the Breadth of the Plates, on their Inside, the Angle *c* coming out backwards, just as far as the Plates: The Depth of this Piece from *a* to *c* is uncertain, because the Plates of some Trunks are broader than of others. The Use of this Piece is, to fill up the lower Part of the Trunk; so that the Seed, dropping upon the oblique Side of this Piece of Wood, may by it be turn'd into the Chanel, after so much Mould is fallen in it, as will sufficiently lessen its Depth, whereby the Danger of burying the Seed is avoided: And such a Piece of Wood placed into each Trunk, I think, is preferable to Ground-wrists, which are commonly used for this Purpose; because the Ground-wrists leave the Channels too wide and open.

But when only the Two hinder Sheats are used for St. Foin, we can make their Channels the shallower, by sinking the Limbers by their Chain, so much as that, the Plough bearing most upon the fore Share, the hinder Shares will go the shallower.

When we drill hilly Ground, both up and down, we cover the hinder Parts of all the Trunks, from their Tops, to within Two or Three Inches of the Ground, to prevent the Seed's falling out far behind the Trunk, in going up Hill; and this we do either by a Piece of Leather nail'd to each Side of a Sheat, the Middle of the Leather bearing against the hinder Part of the Plates (or Trunk); or sometimes, instead of Leather, we use Tin.

Every Trunk being thus inclos'd behind, we can drill up and down an hill of a moderate Ascent; but when it is very steep, we never drill any thing but St. Foin on it, and that by a Drill made for the Purpose, so very light, that a Man may carry it up the Hill

Hill on his Back, and draw it down after him : This Drill has Five or Six Sheats in one Row (with the Harrow behind them). Their Shares being extremely short, the Standards which draw the Hopper must be set perpendicular to the Horizon, when the Drill is coming down, rather than to the Surface of the Side of the Hill : The Funnels must also correspond with the Standards.

Some, instead of these Sheats, make use of hollow wooden Harrow-tines, thro' which the Seed descends : But these I do not approve of ; because where the Ground is hard, and not fine, they rise up, and make no Channels for the Seed ; and then it lying uncover'd will be malted.

When a Drill has only one Rank of Shares, we screw on the Harrow by its Legs, to the Inside of the Two outside Sheats, as near as we can to their fore Shoulders, leaving sufficient room for the Harrow to rise and sink, in the same manner as when it is drawn by the Beams.

C H A P. XXII.

Of the Turnep-Drill.

PLATE 5. shews the whole Mounting of a Turnep-drill. *Fig. 1.* is a Plough, but little differing from the Drill-plough last mentioned. A, A, are the Two Limbers, differing in nothing from the other, except that they are lighter, not being above Two Inches Diameter, behind the Bar : They are drawn in the same manner as the other. Their Bar B is distant from the Plank Three Inches, being shoulder'd at each End, with a very thin flat Tenon, passing thro' each Limber, and pinn'd on their Outsides, as at *a a*. We do not pin in this Bar thro' the Limbers, lest the Holes

Fig I

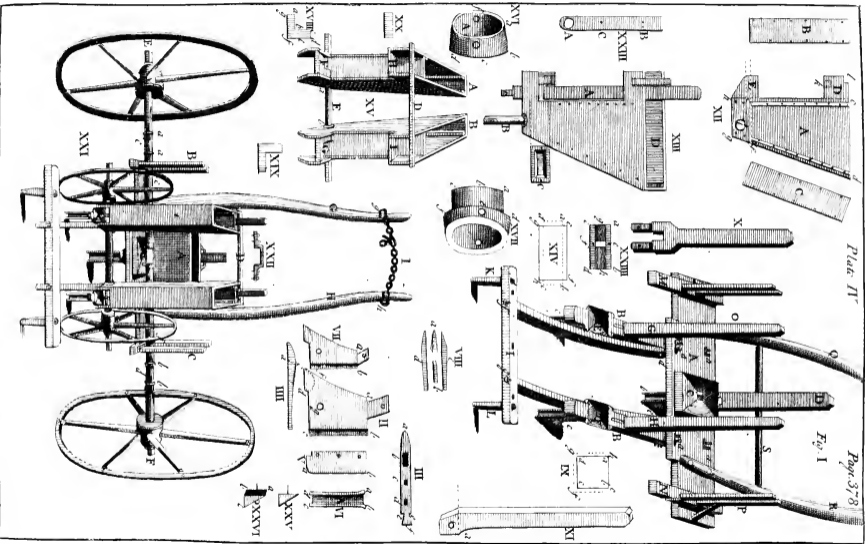

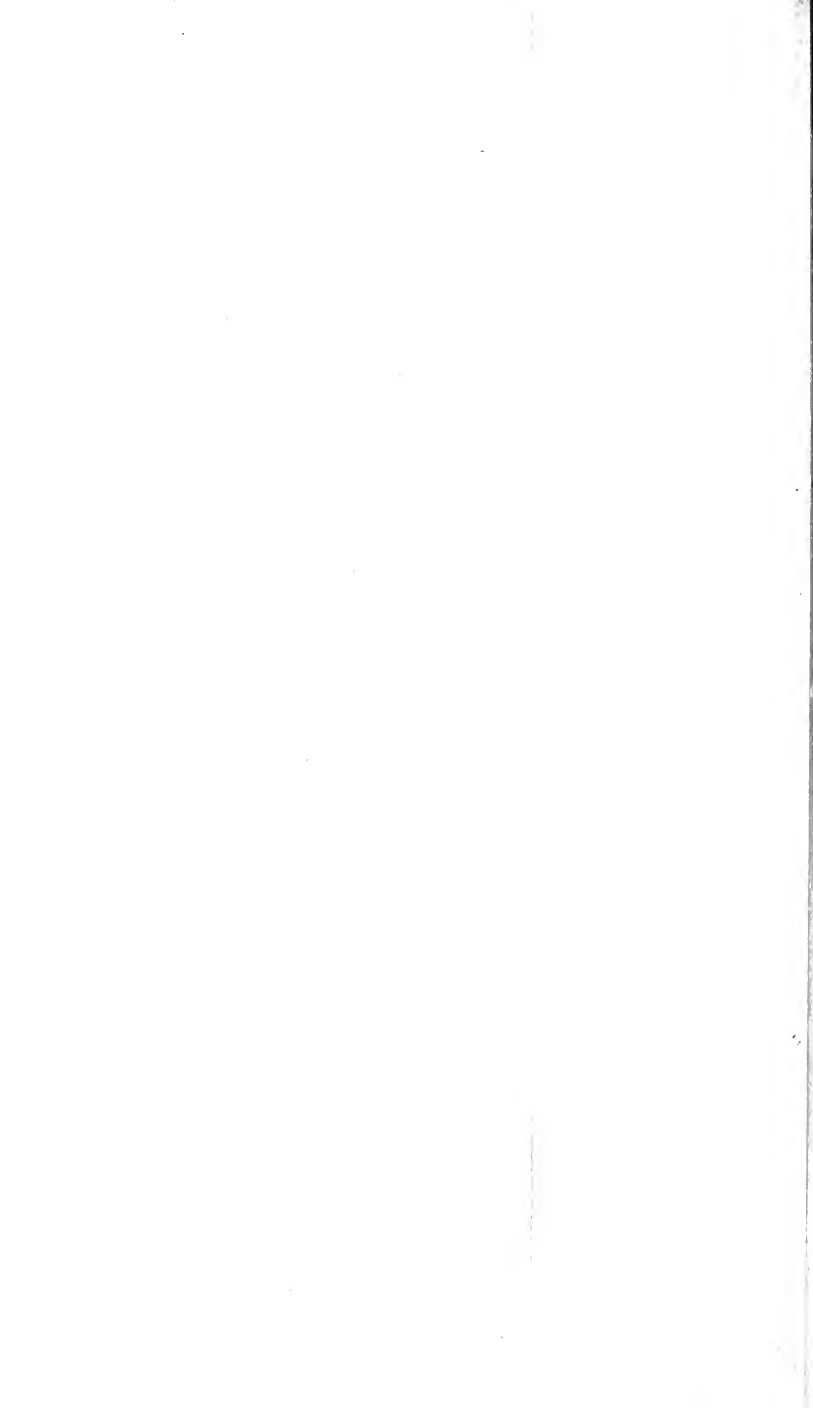

Holes should make these very small Limbers the weaker in that Part. C, the Plank, Two Feet and an Inch long, Five Inches broad, and an Inch and a quarter thick. D, D, the Two double Standards, or Two Pair of Standards, placed into the Plank with Shoulders above, and Tenons pinn'd underneath the Plank, and are Thirteen Inches high above it: These serve for a Pair of Marking-wheels, when Turneps are drill'd on the Level, to keep the Rows all parallel, and at what Distance you please, by setting them according to the Rule already laid down.

Sometimes we place the double Standards into the Plank of the Wheat-drill, in the same manner that these are placed.

We take off the inner Edge of each Standard at the Top, as at *bb* and *b b*, for the more easy Admission of the Spindle of the Marking-wheels into the Forks: This Spindle is kept in its Place by Two of the same sort of Wreaths, and placed in the same manner as those describ'd for the fore Hopper of the Wheat-drill.

Such Marking-wheels are necessary for drilling upon the Level; but not for drilling upon Ridges.

E is the Beam, Two Feet Two Inches and an half long, Four Inches broad, and Two Inches thick: It is thus broad, that the Screws which hold on the cross Piece F, may be farther asunder: The Screws must be placed as near as may be to the Outsides of the Beam, and at equal Distance from each Side of the cross Piece; by which means the Standards are kept the firmer from Turning.

The Distance between the Plank and the cross Piece is Eleven Inches. The Breadth of the cross Piece is Two Inches and a quarter. This cross Piece is shewn apart in *Fig. 2.* where its Two Standards A B, are each Seventeen Inches long (or high), and each on its fore Side and hinder Side One Inch and a quarter broad, and nearly Three quarters of an Inch thick: They are
shoulder'd

shoulder'd and pinn'd into the cross Piece at *a b*. The cross Piece is Thirteen Inches and an half long, and one Inch and a quarter thick in the Middle from *c* to *d*; but for about an Inch on the Inside of each Standard is Two Inches and an half thick, that the Standards may have the more Wood to support them, and that the Hopper, bearing upon the thicker Parts of the cross Piece, may be held up above the Funnel, that the Fork of the brass Spindle may not strike against it, when the Plough is taken up to be turn'd, there being a little more than a quarter of an Inch of the Breadth of the cross Piece behind the Standard, for the Hopper to rest on.

The whole Distance between the Standards is Nine Inches and a quarter. The Standards must be exactly perpendicular to their cross Piece: Their Tops are drawn up each to a Point, as at *e* and *f*, by which the Hopper is the more easily put on upon them.

The Funnel, Sheat, Share, and Trunk, are the same as those in the Wheat-drill, except a few Differences: As *G* in *Fig. 1.* is the same as the fore Sheat of the Wheat-drill, with its Accoutrements; only it is lower, being but Eight Inches high from the Bottom of the Share up to the Beam; and the Plates of the Trunk are somewhat narrower: Its Tenon passeth thro' the Beam, and comes up above it, betwixt the Funnel and the cross Piece; and there is pinn'd in thro' its Hole above the Beam. There is no want of Wood behind the Sheat, the Funnel not being cut in the Beam, but placed upon it.

The Funnel is shewn apart in *Fig. 3.* and is Two Inches deep, Four Inches square at Top; its Four Sides terminating at an Hole in the Bottom, half an Inch broad from *a* to *b*, and near an Inch long from *c* to *d*; which Length is divided in the Middle, by the upper Edge of a Brass Spout, which divides the Hole into Two equal Parts (or Holes), each of which

is about half an Inch square; this Funnel being screw'd on upon the Beam by Two Wood Screws, entering at Two opposite Corners of the Funnel, as at *c d* in *Fig. 1.* so that the Seed may drop from the Seed-box upon the right Side of the Funnel at *e*, which being about half an Inch distant from the Partition, and equidistant from both Holes, the Seed rebounding is pretty equally distributed to each of the Holes.

The fore Part of the foremost Hole being equal with the Back of the Sheat, the Beam being cut thro'; so that the Back of the Sheat, and the fore Part of the Hole thro' the Beam, and the fore Part of this Hole, make one plain Surface, whereby the Seed that falls into this foremost Hole, descends to the Ground, near the Back of the Sheat, thro' the Trunk.

And the Seed which falls into the hinder Hole, is convey'd obliquely backwards thro' Part of the Beam, by a short thin Brass Spout, whose Diameter in the Inside is somewhat more than half an Inch; but the fore Part of it, which divides the Two Holes, descends first perpendicularly half an Inch, and then turns off backwards, and there the Spout begins to be round: Its joining is on its hinder Part, to the end that the Seed, never running upon it, cannot be stopp'd by it. The lower End of this Spout ends at the lower Surface of the Beam, a little behind the Plates of the Trunk, which Hole is seen at *a* in *Fig. 4.* where this Hole delivers the Seed down into the Spout *A*, when it is drawn up into its Place by the String *B* drawn thro' the Hole at *b* in the End of the Beam, and there tied until it stand in the Posture in which it is seen at *f* in *Fig. 1.*

The Shape of this Spout is better seen at *Fig. 5.* where *A* is the Spout, Four Inches long, a full Inch Diameter in the Inside: Its lower End is circular; but its upper End *B* is cut at oblique Angles, so that when it is drawn up to its Place, its Edges will touch the
lower

lower Surface of the Beam, and inclose the lower End of the other Spout within it: It is made of thin hammer'd Brass (as is the other). The Edges of the Piece of Brass, which make this Spout, are join'd on its hinder Part, for the same Reason that they are so in the other Spout. At *b* there is a Jag cut in one of these Edges, and rais'd upwards, by which Jag the String being tied on the Spout just below, is hindered from slipping upwards.

Joining to the highest Part, and made with Part of the same Piece of Brass, turn'd back from the End of the Spout, is its Hinge *C*, near Three quarters of an Inch long in its Hollow.

D is a thin Piece of Iron, half an Inch broad, and a little longer than the Top of the Sheat, by which the Spout is held up: This Piece of Iron is riveted by a Rivet passing thro' an Hole at *c*, and thro' the Sheat, just before the Trunk, and thro' another Piece of Iron on the opposite Side; both the Pieces of Iron, with their upper Edges touching the Beam, being thus riveted to the Sheat.

The Spout is pinned in by the Screw *E*, passing as by the prick'd Line *F* thro' the Hole *G*, and also thro' the Hinge *C*, and screw'd into the Hole of the opposite Piece of Iron, corresponding with the Hole *G*; and then it will appear as in *Fig. 4*.

Instead of these Pieces of Iron, we sometimes use Pieces of Wood, a little broader and thicker, nail'd on the Sheat.

The Use of this Spout is for carrying half of the Seed backwards, so that it may drop upon the Channel, after the Earth is fallen into it: By this means the Seed lying very shallow, being only cover'd by a little Earth rais'd by the Harrow, by its Shallowness comes up in moist Weather, sooner than the other half, which lies deeper in the Ground; but if the Weather be dry when planted, the deeper half, by the Moisture of the Earth from the Dews, will come up first,

first, and the shallow half will not come up till Rain come to moisten it; so that by the shallow or deep, the Turnep-fly is generally disappointed.

Fig. 6. shews one of the Tines of a Drill-harrow made of Wood: Its Edge *ab* is made roundish at *b*, by which means it raises the Earth on its Sides; but does not drive it before: This Edge from *a* to *b* is Six Inches long; from *b* to *c*, being its Bottom, is One Inch and a quarter; from *c* to *d* is the Back, an Inch and an half thick at Top, gradually tapering downwards to *c*, where it is half an Inch thick, being shoulder'd all round: It has a flat Tenon A, which passes thro' a Mortise in the Harrow-head; the Length of which Mortise is parallel with the Length of the Harrow-head, into which it is held by a Pin, passing thro' the Hole of the Tenon, above the Harrow; as may be seen in *Fig. 7.* at *a*; and its Fellow at *b*.

These Two Tines are Eight Inches asunder at their Points, and Six Inches and a quarter asunder at their upper Parts, just under the Harrow-head. The fore Edge of the Tine A inclines a little to the Left, as the Edge of the Tine B doth to the Right.

Fig. 8. shews one of the Legs of the Harrow. At *a* is seen the round Tenon, which passes thro' the Harrow-head up to its Shoulder, and is pinned in thro' an Hole of the Tenon just behind the Harrow-head; upon this Tenon the Harrow-head may turn: The other End has an Hole at *b*, thro' which it is pinned on to the Beam. The Length of the Leg from the Shoulder at *a*, to the Hole at *b*, is Twenty Inches: Its Thickness is an Inch and a quarter, and its Breadth an Inch. The Two Legs are seen mark'd C, D, in *Fig. 7.* They bend down in the Middle, to give the Harrow the more room for rising and sinking; they are parallel to each other, and distant a little more than the Breadth of the Beam, that they may have Liberty to move thereon, when one End of the Harrow-head sinks lower than the other, by the Unevenness of the Ground.

The

The Harrow is pinned on to the Beam by the Iron Pin, *Fig. 9.* passing thro' the Hole of the Leg at *g*, and thro' the Beam, and also thro' the other Leg on the other Side of the Beam, where the Screw at the End of the Pin has a Nut screw'd on it. This Pin is round from its Head all the Way thro' the first Harrow-leg, and thro' the Beam; but all that Part of the Pin, which is in that Leg against which the Nut is screw'd, must be square; whereby that Part being bigger than the round Part of the Pin, and than the Hole in the last-mention'd Leg, cannot turn in the Hole of that Leg; for if it did, the Nut would be soon unscrew'd by the Motion of the Harrow; but the Pin must have room to turn in the other Leg, and in the Beam. This square Part of the Pin is seen at *a*, *Fig. 9.* The whole Length of the Pin, from its Head to the End of the square Part at *a*, where the Screw begins, is of the Thickness of the Two Legs, and of the Breadth of the Beam.

We sometimes set the Legs of the Harrow Two Inches wider asunder, by making them each an Inch thicker at their fore Ends in their Inside, and reaching Five or Six Inches behind their Iron Pin: These thicker Parts, bearing against the Beam, keep the hinder Part of each Harrow-leg an Inch distant from the Sides of the Beam, whereby the Harrow-legs are Six Inches asunder, instead of Four, by means of these added Thicknesses.

When a Drill is taken up to be turn'd, the Person that does it, takes hold of the Harrow-head, and lifts it up: The Legs of the Harrow, bearing against the cross Piece, support the whole Weight of the Drill.

When the Harrow does not go deep enough, we tie a Stone upon the Middle of the Harrow-head, by a String that passes thro' the Holes at *b*. All the Wood of this Plough and Harrow is Ash, except the Limbers.

The Hopper of the Turnep-drill is very different from those already described. It consists of a Box placed into the Middle of a Carriage; which Box is described in all its Parts, lying open with their Insides upwards in *Fig. 10.* A is the fore Side of the Box, Five Inches and an half deep, and Six Inches and an half long. B, the hinder Side of the Box, opposite to the former, and of equal Dimensions.

Each End of the Box is made with Three Pieces of Board, of which C the uppermost is Three Inches and a quarter deep, and Five Inches long; which Length is the Breadth of the Inside of the Box. The End of the Piece C, when in its Place, stands against the prick'd Line *a b* in the fore Side A; the other End standing against the prick'd Lines in B, which is opposite to, and corresponds with, the prick'd Line *a b*; the fore Side, and hinder Side, being screw'd to the Ends of this Piece by Four Screws.

The Piece D is Two Inches and a quarter broad, and of the same Length with the Piece C, and screw'd up to the Bottom of it with Two Screws, and then its End will bear against the prick'd Line *b c*, and that which is opposite to it in the Side B.

E is the lower Piece of this End, and an Inch and a quarter broad: Its End is to stand against the prick'd Line *c d*, and its other End at the opposite prick'd Line in B. The Piece D must be screw'd upon the upper Edge of the Piece E, as the Bottom F must be screw'd up to its under Edge, which will stand upon the prick'd Line *e f*. The Three Pieces G, H, I, being opposite to C, D, E, and of the same Dimensions with them, placed in the same manner, make the other End of this Box. At *g* in the Bottom F, appears the Hole which is over the Mortise of the Brass Seed-box, the Shape and Size of which Hole may be seen by the prick'd Lines upon the Flanches B, C, of *Fig. 9.* in *Plate 2.* The foremost End of which Hole reaches almost as far forwards as the

C c

End

End of the Axis of the Tongue of the Brass Seed-box, and its hinder End almost as far as the hinder End of its Cover (*a*). The Bottom F, being of the same Length, with C, D, E, and their Opposites, bears against the prick'd Line *db* of the fore Side A, and against the opposite prick'd Line of B. The Length of this Bottom F is the Breadth of the Inside of the Box, and its Breadth reaches to the outer Edges of the Pieces E and I, being Three Inches and an half.

All the Jointings of these Pieces must be at right Angles, and so close, that no Seed may run out at them. All the Pieces are of Board, full half-inch thick, except the Bottom, which is thinner.

Fig. 11. shews the Bottom of the Box with its under Side uppermost, where the light Part A is the Bottom-board, covering the Two End-boards, E and I, in *Fig. 10.* The dark Parts B and C are the under Sides of D and H, in *Fig. 10.* At *a* is the fore End of the Brass Seed-box screw'd up to this Bottom-board. At *b* is the hinder End of the Brass Seed-box screw'd up in like manner, the outer Edge of the Flanch of the Seed-box being even with the Edge of the Bottom-board. The End of the Brass Spindle, with its Fork, appears at C.

Fig. 12. shews this Box standing upon its Bottom, with its hinder Side laid open. At *a* is the Hole in the Bottom, under which the Brass Seed-box is fasten'd, with small Iron Screws, square near the Heads, passing thro' the Bottom, and thro' the Holes at each End of the Brass Box, with their Nuts underneath.

(*a*) Commonly it reaches within half a quarter of an Inch; but if it should only reach within a quarter of an Inch of them, it would not have that ill Consequence at that Distance, as the same Position would have in the large Seed-boxes; for, in them, the Seed would, in such Case, be apt to bear against the Bottom of the Hopper, and obstruct the Motion of the Brass Tongue, which small Seeds cannot do in the Turnep-feed Box.

The Pins must touch all the Sides of the Holes in the Brass, to prevent the Seed-box from moving any Way.

A is the fore Side of the Box. B the hinder Side lying down. C is the Piece H of *Fig. 10.* which makes a sort of Shelf in the Box at its left End. D at the right End makes another like Shelf, underneath which, the Fork of the Brass Spindle is turn'd by the Crank in the End of the wooden (false) Spindle. By means of these Shelves, there is room for the Two wooden false Spindles to come the further into the Carriage, without lessening the upper Part of the Box. E and F are the Two Ends of the upper Part of the Box, made by the Two Pieces G and C of *Fig. 10.* When the hinder Side B is rais'd up, and screw'd to these Ends, the Box is complete.

We put a Lid upon this Box, which is hing'd on to its right or left End. This Box (having the Brass Seed-box at its Bottom) is to be placed into the Middle of a Frame or Carriage.

Fig. 13. shews the Inside of the Carriage lying down. A is the hinder Side, Eighteen Inches long, Dove-tails and all, and Six Inches broad. B the fore Side of the same Length with the hinder Side, and Eleven Inches broad. This Five Inches greater Breadth than the hinder Part is, because a greater Height is required on the fore Side, on account of the Hopper's being drawn, and the Plough held up by that and the Pieces that must be fix'd to it. C, D, are its Two Ends, Six Inches long, beside their Dove-tails, and Six Inches broad. E and F are Two Pieces each Six Inches long, whose Ends are to stand against the prick'd Lines *a b* and *c d* of the hinder Side, and their other Ends against the prick'd Lines in the fore Side, which are opposite to these. The Breadth of each of these Pieces is Four Inches: When they are in their Places, their lower Edges come even with the Bottom of the Carriage. Their Use is to support

the Ends of the Spindles which come just thro' their Holes, after each of them have passed their Hole at its respective End of the Carriage.

All this Carriage is made of Board full half-inch thick; The Ends C and D are made of double Thickness by another Piece of Board added to each, that covers all their Insides, except their Dove-tails. These Boards with which they are lin'd, are nail'd to them, with their Grain going a different Way, and crossing the Grain of the Board at the End, either at right or oblique Angles. This prevents the Holes from splitting out, and makes the Holes of a double Thickness; whereby the Spindle is the less worn by them, in case there are no Bras Wreaths to enter them.

The middle Pieces E and F are lin'd by their whole Surfaces, in the same Manner as the Insides of the Ends are lin'd.

When these Ends and middle Pieces are in their Places, a wooden Cylinder, of the exact Diameter of the Holes, is thrust thro' all Four, to hold them exactly true, whilst the Ends and middle Pieces are all screw'd fast into their Places.

The prick'd Lines are drawn all round the Carriage, thro' the Centres of the Holes, and at equal Distance from the Bottom of the Carriage, which is an Inch and Three quarters, and the One-eighth of an Inch. This prick'd Line is a Direction how high to nail on the Ledgers G and H, whereon the Box is to stand; and the Distance the upper Surface of the Ledger must be above the prick'd Line, is the Semidiameter of the Bras Spindle; and the Thickness of the Bras Box above the Spindle, or which is the same thing, the Distance between the Centre of the great Hole of the Bras Seed-box, and the Plane of the Top of its Mortise, being half an Inch and half a quarter, strike a Line above the prick'd Line parallel to it, at this Distance above, and then nail on the Ledger,

with

with its upper Edge at this Line. This, with its opposite Ledger plac'd in the same manner, will support the Box with the Axis of the Spindle of the Seed-box, at equal Height with the Centres of the Holes of the Carriage; so that if those Holes are parallel to, and equidistant from the fore Side and hinder Side of the Carriage, and the Axis of the Brass Spindle be placed in the like manner parallel to, and equidistant from the fore Side and hinder Side of the Box; then when the Box is thrust down in its Place, upon these Ledgers, and the wooden (false) Spindles are placed into their Holes, their Axis will fall into a strait Line with the Axis of the Brass Spindle, as they ought.

Fig. 14. shews the Carriage laid open. A is its back Side lying down. B is its fore Side standing up. C is the square End of the left (false) Spindle, whereon a Wheel is to be put up to the Shoulders of the Spindle, quite close to the Ends of the Carriage. This Spindle, being an Inch and an half Diameter, is held in its Place, and kept from moving end-ways, by Two Wreaths; the one at *a*, bearing against the Inside of the End of the Carriage, the other Wreath at *b*, bearing against the left Side of the middle Piece; which Wreath keeps the Spindle from moving towards the right Hand, as the other does from moving towards the left. D is the square End of the other wooden Spindle, whereon a Wheel must be placed in the same manner as the other Wheel. This Spindle is kept from moving end-ways by Two Wreaths, in the same manner as the other Spindle is; but this right-hand Spindle, being that which turns the Brass Spindle by its Crank, which enters the Fork, should have its Wreaths of Brass, like those describ'd in *Fig. 17.*

Plate 4. Part of which Wreaths entering about Three quarters of an Inch into the Hole of the End and middle Part of the Carriage, being firmly screw'd on to the Spindle, prevent the Friction that would otherwise be betwixt the Wood of the Spindle, and the

Wood of the Holes; which Friction wearing the Wood of both, would in time cause the Spindle to be loose in its Holes, whereby its Axis would deviate from the strait Line it should make with the Axis of the Brass Spindle, and make an Angle with it; and then the Crank would change its Place in the Fork at every Revolution of the Wheels; and if the Hole should be worn very wide, and the Spindle worn much less, the Crank might let go the Fork; but when the Wood is of this Thickness, and each Hole has Wood in it, with its Grains pointing different ways, it would be many Years before the Holes would become large enough for this to happen, tho' only wooden Wreaths were used; and as to the Two Wreaths of the left Spindle, they may be of Wood, because tho' that Spindle should grow loose, it is no Damage; for it only serves to bear up that End of the Carriage; but he that has this Sort of Brass Wreaths for the hinder Hopper of a Wheat-drill, may take them thence, and place them upon these Spindles, and remove them again to the Wheat-drill when that is used; for that and the Turnep-drill are very rarely, or never, used at the same time.

E is the Iron Crank, plac'd into the false Spindle, in the manner shewn at H in *Fig. 5.* of *Plate 2.* for turning the Brass Spindle by its Fork; but take care that the End of this wooden Spindle do not approach nearer to the End of the Brass Spindle than the Distance of half an Inch, lest, if the inner Wreath should grow loose, the wooden Spindle might bear so hard against the Brass one, as to wrench the Seed-box down from the Wood, and then the Seed might run out betwixt the Seed-box and the Bottom to which it is screw'd.

When the hinder Side A is screw'd up against the Ends and middle Pieces, then the Box describ'd, being thrust down into the Carriage, and standing upon the describ'd Ledgers, and at that Distance from each

End

End of the Carriage, that the Seed may drop on the Side of the Funnel, as is before describ'd; the Box is kept in its Place by one Screw passing thro' its Back, and the back Side of the Carriage.

The Notch F is cut in the Bottom of the hinder Side of the Carriage, up to the Bottom of the Ledger, for the Convenience of seeing the Seed drop into the Funnel.

The round Notch G is made in the Bottom of the fore Side of the Carriage, to make room for one's Hand to go in there, and turn the Setting-screw without taking off the Hopper from the Standards.

This Box and Carriage, so fix'd together, compose the Turnep-hopper, which is drawn and guided, and also holds up the Plough, by Two hollow Pieces of Wood screw'd on to the Outside of the fore Part of the Carriage; their Ends H and I appearing a little above the Carriage.

One of these hollow Pieces of Wood is shewn in *Fig. 15.* The Breadth of its Hollow must conform to the Breadth of the Standards, which are One Inch and a quarter broad; but we must allow about a quarter of an Inch more in the Hollow for the Swelling of the Wood. The Depth of the Hollow must be the Thickness of the Standard that is to go in it, allowing about the Eighth of an Inch for the Swelling of the Wood. The Hollow should be a little deeper in the Middle than at each End; because the Standard ought not to bear against any thing, except at or near the upper and lower Part of the Carriage. Altho' the End of these Pieces come a little higher than the Carriage in this Hopper, yet I think it is better that these hollow Pieces come no higher than even with the Top, nor descend any lower than even with the Bottom of the Carriage; and then the Length of each of these Pieces need be no more than Eleven Inches, which is the whole Depth of the Carriage.

The Wood on each Side of the Hollow, sufficient for the Holes *a, a, a, a*, must be about half an Inch broad. The best way for fixing them on, is whilst the Standards are in them, placing a small Piece of Wood at each Corner of the Hollow, betwixt the Standard and the Wood, to the end that there may be no more room on one Side of a Standard than on the other Side; then screw them on (parallel to and equidistant from their respective Ends of the Carriage) by Four small Screws each, the one at *c, c, c, c*, and the other at *d, d*, with Two below; the Heads of these Screws being on the Inside of the Carriage, and their Nuts on the Outsides of the hollow Pieces; then pull out those little Pieces of Wood, that were to keep the Standards in the Middle of the Hollows, whilst the Holes for the Screws were bored, and then the Turnep-Hopper is finished, and being put on upon the Standards *A, B*, in *Fig. 16.* is ready to go to Work; and in this Figure the whole Turnep-drill may be seen as in the Prospect of a Person following it at Work, except that this Figure has not the double Standard, nor Marking-wheels; because we never use them for drilling-Turneps, except it be on the Level, which we very rarely do.

The Circles of the Wheels of this Hopper go Twenty five Inches asunder; were they farther asunder, they would not go so well upon the Ridges; or were they nearer together, they might not hold up the Plough so steadily, but that one Wheel might happen to be rais'd from the Ground, by the descending of the opposite Limber; and if it should happen to be the Wheel that turns the Crank, no Seed would be deliver'd out whilst the Wheel was rais'd above the Ground; sometimes we use Wheels of Twenty-six Inches Diameter, sometimes Thirty, and at intermediate Diameters, with this Hopper.

The best Wood for making all Sorts of Hoppers is Walnut-tree or Elm; our Beams and Standards we make of Ash. What

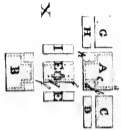
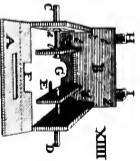
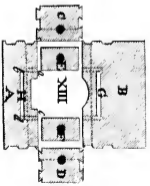
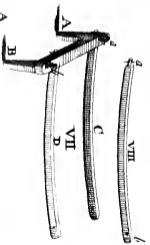
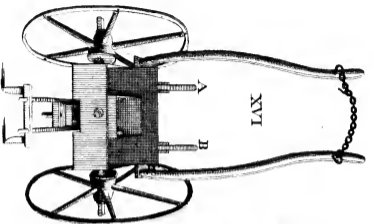
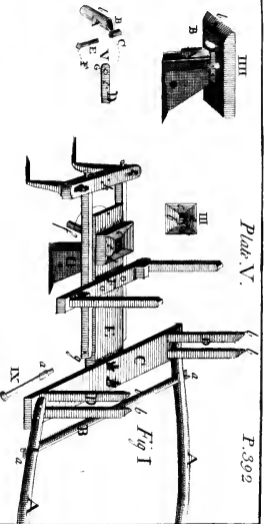

Pat. D. P. de la d. d. d.



What is meant by Wood-screws, are taper Screws made with Iron, having very deep Threads, whereby they hold-fast when screwed into Wood, and their Points will enter into soft Wood without boring any Hole for them into the Wood they are to take hold of; but near their Heads they are round, and have no Thread, and that Part of them must always be in a bored Hole thro' that Part of a Board that is to be drawn close.

If the Standards should be much swollen by being wet, it may be proper to anoint them with Soap.

In drilling, when the Wind is very strong, and the Hopper goes high above the Funnel, the Seed might be blown over it, if we did not take care to guard it from the Force of the Wind; and for doing this there are many Ways: Sometimes we nail a Piece of Linen Cloth round the Ends, and the fore Side of the Hopper; or else we nail on a Piece of old Hat, or Shoe-leather, round the Edges of the Funnel, to raise it higher; or if the Hopper go a great deal above the Trunk, we nail up a Pipe of Leather to the wooden Bottom of the Box, which Pipe, being about an Inch wide at Bottom, protects the Seed from the Wind, till it arrives so near the Funnel, that the Wind cannot blow it over.

If we would have a long Hopper, to plant many Rows at once, of Clover or other fine Seeds, it is easy to make each of these wooden (false) Spindles turn Two or Three Brass or Iron Spindles; but then, as in all other Cases; where the same Hopper is to supply more than one Chanel with Seed, each of its Wheels must have Liberty to rise without the other, as those of the hinder Hopper of the Wheat-drill do,

C H A P. XXIII.

Of the HOE-PLOUGH, &c.

P L A T E 6. *Fig. 1.* is the Hoe-Plough in a side View. A is the Beam and Plough-tail, being much the same with that of the common Plough described in *Fig. 1.* of *Plate 1.* The Beam of such a common Plough, being cut off, and screwed up to this Plank, and its Limbers, might make a Hoe-Plough. The Share of this, from its Tail to the fore Part of its Socket, is Two Feet One Inch long, and from thence to the End of the Point, Ten Inches and an half: This is the Measure of the under Side of the Share. B is the Plank, Two Feet Seven Inches and an half long, Two Inches and an half thick, and Nine Inches broad. C, D, are the Nuts of the Two Screw-pins, which hold up the Beam to the Plank. E is the Nut of the Draw-pin, which Pin has a Crook underneath, whereto one of the Links of the short Chain of the Whipper is fastened for drawing the Plough; the only Use of this Nut is, to hold the Pin from dropping out by its own Weight, and that of the Chain and Whipper; but often, to avoid the Trouble of screwing and unscrewing the Nut, we supply its Use by a square Pin a little bigger than the Hole, which we drive up by an Hammer, so tight, that it may not drop out of itself; but can easily be driven out by a few Blows of the Hammer, as often as it is necessary to remove it into another Hole. F, G, are the Two Limbers; they are screwed on to the Plank by Four Screws and Nuts: The under Surface of the Limbers by their whole Length are parallel to the Plank, and to the upper Surface of the fore
End

End of the Beam, contrary to the manner of placing the Limbers of the Drill Ploughs; because their Planks being always parallel to the Bottom of their Shares, if their Limbers were parallel to their Beams, as these are, the fore Ends of their Limbers would not be elevated higher than the Plank, but would go within a Foot of the Ground, instead of being elevated almost as high as the Horses that draw them; and the upper and under Surfaces of this Plank must not be parallel to the Share, but must make the same Angle with it as its Limbers and Beam do.

These Limbers ought to crook outwards from each other all the Way, till they come within about a Foot of the Chain, much more than the Drill-Limbers need to do; because the Middle of the Plank of the Drill follows directly after the Horse, but the Middle of the Plank of the Hoe-Plough very seldom does; and therefore there must be the more room betwixt these Limbers. Likewise there must be the more room betwixt the fore Part of the Limbers, because oftentimes the right Limber must be raised, and the left depressed, in holding the Plough towards the left Side (for if it should be held towards the right Side, the Share would go upon the Fin, and its Point be raised out of the Ground, unless it were on a Surface that had a Declivity towards the Right). The Distance between the fore Ends of these Limbers is Two Feet Eight Inches.

The Strength and Stiffness of these Limbers must be such, that there may be no Bending betwixt their fore Ends and the Tail of the Beam; for if they be too weak, so as to yield to the Weight of the Furrow, the Point of the Share will descend into the Ground, and its Tail will rise up, and then the Plough cannot go well. The shorter they are, the stronger and stiffer will they be, of the same Thickness. We may make them just of such a Length, that there may be room for the Horse before the Bar H (which holds the Limbers at their due Distance). These are from
their

their Ends to the Bar, Four Feet Ten Inches long and from thence to the Plank Ten Inches, and Three Inches and an half square at the Bar.

I is the Whipper. K, L, are its Notches, whereunto the Traces both of the Thiller, and of the Horse next before him, are fastened. The Length of the Whipper is uncertain; but when we hoe betwixt Rows, when the Plants are grown high, we make it as short as it can be, without galling the Horse's Legs by the Traces.

We set this Plough to go deeper or shallower by the Chain of the Limbers; the changing of whose Links to the Crook M has the same Effect as changing the Pins to different Holes of the Crow-staves of a common Plough.

Fig. 2. is the Beam with its Mortise and Holes; its Crooking down at the Tail is not very material; but it causes the hinder Sheat to be a little the shorter below the Beam, whereby it may be something the lighter, and yet of the same Strength as if it were longer. Its whole Length is Four Feet Ten Inches: We make its Breadth and Thickness such, that it may be as light as it can be without Bending. A is the Mortise thro' which the hinder Sheat passes. B is the Mortise for the fore Sheat, upon which it is pinned up. C is a Hole in the Beam, into which the End of the left Handle being driven, holds it from moving, and is the best Manner of fastening this Handle of a Plough. D, E, are the Holes, thro' which the Two Legs of the double Retch pass, and are there held up by their Nuts. F is the Coulter-hole. G is the hinder Hole, by which the Plough is held up to the Plank. H and I are the Two foremost Holes of the Beam, thro' one or the other of which passes the Pin which holds the Beam to the fore Part of the Plank. These Holes must be made as near together as they can be, without Danger of splitting them one into another; to prevent which there are several Ways: The one is by driving in Two square Pins cross the Beam, under the

the pricked Line *a b*, before the Holes are bored, which will prevent the Grain of the Wood from being forced out of one Hole into the other; or these Holes may be plated with Iron above and below, which will have the same Effect, and then there need not be more than One Inch between Hole and Hole.

Fig. 3. is the Plank apart, which by its Holes, and pricked Lines, shews the different Manner of placing the Beam. *a a, a, a*, are the Four Holes for screwing down the Limbers to the Plank.

Supposing the Path of the Horse to be a strait Line, and the pricked Line *b i* (which is at right Angles with the Plank, and equidistant from each Limber) to go exactly over it, without making any Angle on either Side of it; then the Beam must be placed at right Angles with the Plank, to the End that the Share may go parallel to the Horse-path, excepting that very small Inclination that its Point has to the left, shewn by the pricked Lines in *Fig. 1.* of *Plate 1.* But this Plough seldom follows the Horse in that manner. The said pricked Line *b i* generally makes Angles with the Horse-path; else when the Beam stood near the left Limber, and the Draw-pin near the right Limber in the Hole 9. (which it must do to keep the Share parallel to the Horse-path) the Weight of the right End of the Plank and its Limber would be too heavy for the right Hand of the Holder to manage; and if the Draw-pin be removed (suppose) to Hole 7. the Parallelism of the Share with the Horse-path will be lost, and the Point of the Share may be inclined too much towards the Left; and when a Furrow is to be plowed on the right Side of the Horse-path, the Beam must be removed nearer to the Middle of the Plank, and the Draw-pin must be placed on the left Side of the Beam, suppose to the Hole 2. This will bring the greatest Part of the Plank to the right Side of the Horse-path; and then the Share, standing at right Angles with the Plank, will make a very large
Angle

Angle with the Horse-path, and then the Plough will not perform at all. Therefore it being necessary, that the Share always go parallel to the Horse-path, and often as necessary that the Plank go at oblique Angles to the Horse-path; it follows then that the Beam stand at oblique Angles with the Plank, to preserve the Parallelism to the Horse-path; and this cannot be done but by the Holes which are shewn under the pricked Lines which cross the Plank.

The Holes A, B, C, are those to one of which the Beam is screwed up by its Hole G, in *Fig. 2*. These Holes are made as near to the hinder Edge of the Plank, as they can safely be, without Danger of tearing out; which is generally about an Inch distant from the said Edge.

Every one of these Holes are answered by Three others, near the fore Edge of the Plank, as the Hole B has, at the fore Edge of the Plank, the Holes D, E, F. D, E belong to the Hole I of the Beam *Fig. 2*. These Two Holes are made as near together as they can be without breaking into one another. F answers the Hole H in *Fig. 2*. and is made between D and E, as near them as safely it can.

When the Beam is screwed up at B and F, and makes the same Angles with the Plank, as the pricked Line *b c* doth; then the Draw-pin standing in the Hole 8 or 9, will bring the Plough so much to the Left, that the Share will point too much towards the Right; then remove the fore End of the Beam to the Hole D, and then the Beam will make the same Angle with the Plank as the pricked Line *c d*, which may bring the Share to be parallel to the Horse-path nearly enough: But if the Draw-pin should be placed in the Hole 1. then the Plank would go so much on the Right of the Horse-path, that the Share would point vastly too much towards the Left, standing in either of these Two Positions: Therefore the foremost Pin must be removed to the Hole E, and then the Beam
being

being at the same Angles with the Plank as the pricked Line *f g*, it may be parallel to the Horse-path, or so nearly, that by removing the Draw-pin one Hole, it may be made perfectly so.

Note, That tho' here are but Nine Holes for the Draw-pin ; yet we usually make many more in our Planks : And sometimes by changing the Draw-pin either Way into another Hole, tho' that Hole be but an Inch distant from the former, the Share is brought right without any Inconvenience.

The Holes *A* and *C* have each of them their opposite Holes, which (when the Beam is placed into either of the Two) have the same Effect, for keeping the Share parallel to the Horse-path, as the Hole *B* and its Three opposite Holes have ; and if either of the Holes belonging to *A*, *B*, or *C*, should not bring the Beam sufficiently oblique to the Plank, for the Share to be parallel to the Horse-path, when the Draw-pin is in some one particular Hole, then there may be another Hole bored before, on the Right or Left, for the fore Pin to pass thro' by the Hole *H* of the Beam *Fig. 2.* which will incline the Beam a little more to the Right or Left, as occasion requires ; and if none of all these be sufficient, the Plank may be turned the other Side upwards ; and the Beam being fastened there by the hinder Screw into any one of those Holes, which were next to the fore Edge of the Plank before it was reversed, there may be a new Set of Holes to answer the fore Pin, of which that which was an hinder Hole before the Plank was reversed, may be one. These may set the Beam at different Angles from any of the first Holes ; so that there may be at one End of the Plank Six Systems of Holes, Three on the one Side, and Three on the other ; and if we have a mind to make yet more various Positions of the Plough, we may turn the Plank, End for End, and there make Six different Systems of Holes.

But,

But, instead of turning the Plank, it would be better to have a Fourth Hole in the Beam, standing as near to the hinder Hole as H doth to the fore Hole; to answer which Fourth Hole, there may be Two Holes in the Plank, one at each Side of the hinder Hole of every System at proper Distances, to set the Plough still at more different Angles with the Plank; and these, I believe, will be more convenient for the Purpose than the different Holes in the fore Part of the Plank, it being easier to remove the hinder Screw than the fore Screw; because if the Plank and Limbers are not held up by somebody, whilst the fore Pin is out, their Weight will wrench out the hinder Hole of the Plank by that Screw; but whilst the hinder Screw is out, there is no need of holding up the Plank, because its Weight, bearing upon the Beam, cannot injure the foremost Hole, whilst the Limbers bear upon the Horse. Upon this account, I wonder we had not made the Holes, for changing the Position of the Beam, at the hinder Part of the Plank rather than the fore Part; which convinces me, that new Instruments are seldom perfect in the Beginning.

We can also alter the Standing of the Beam, by cutting away the Wood on one Side of an Hole, and placing a Wedge on the opposite Side of the Pin.

The Holder may make some Alteration in the Going of the Plough by the Handles.

The Reason we never set the Beam on the right Half of the Plank is, that the Plough always turns its Furrow towards the Right-hand; and the strait Side of the Share and the Coulter never go so near to a Row on the Right-hand, by the Breadth of Two Furrows, as it does to a Row on the Left-hand.

If by the Drawing of the fore Horse or Horses, the Plough should bear too hard upon the Thiller, it may be helped by making a Row of Holes near the hinder Side of the Plank, for the Draw-pin, instead
of

of those in the Middle; for the farther backwards the Draw-pin is plac'd, the less will the Limbers bear on the Thiller, especially when drawn by more Horses than one; because the fore Horses draw the Limbers more downwards than the Thiller doth, as may be seen in *Fig. 4.*

Fig. 4. shews the manner how the Hoe-plough is drawn, and how the Traces are fix'd to it. The Traces of both Horses are fastened to the Notches of the Ends of the Whipper at *a* and *b*. The Traces of the Thiller by their fore Part are fastened to an Hook, or Ring, on the Wood of the Collar, as is usual for other Thillers; and the fore Part of the next Horse's Traces is fastened to his Collar in like manner; but these Traces, being twice as long as those of the Thiller, must be held up in the Middle by a Piece of Cord or Chain; as at *c*; where one End of it is fastened to the Trace, and passes over the Top of the Collar, behind one of the Hames, and before the other to keep it from slipping backwards or forwards; its other End is fastened to the opposite Trace on the other Side, as this End is at *c*: This prevents the Chain from falling down, and getting under the Horse's Legs in turning; but beware that this String or Chain be not so short as to hold up the Traces higher than their strait Line; for that would press upon the Collar, and gall the Thiller, besides occasioning the Plough to be drawn too much upwards; for this drawing of the fore Horse by a different Line from that of the Thiller, is a great Advantage for keeping the Plough the firmer into the Ground.

If there is another Horse, his Traces are fastened at the Collar of the Second, in the same manner as in drawing of a Waggon.

When we hoe betwixt Rows, where the Plants are very high, as those of Turnep-seed, which are much higher than the Horses, to turn a new Furrow up to the Row, when there is a Trench in the Middle of the Interval, where the Horses must go, we find it best

to place the Beam by the Holes B and E, in *Fig. 3.* and the Draw-pin near the left Limber, which brings the Tail of the Plough to the Right-hand, and the fore Ends of the Limbers being towards the Left, the End of the right Limber (by turning the Handles a little to the Left) bears against the wooden Saddle at *d*, and cannot hitch into or take hold of any of the Plants to tear them. And that no Part of the Limber may take hold of any Plant, we make it very smooth from one End to the other; and cut off the Corner of the Plank equal with the Limber, that the Plants may slip by it without hanging in it, or being broken by it. The Whipper standing towards the left End of the Plank, its End *b* does not reach so far towards the right as to take hold of the Plants, its End *a* being over the Interval, where no Plants are; and to keep its right End the more out of Danger of hurting the Plants, we place the Hook of its Chain nearer towards this End, by which means the left End, becoming heavier, sinks lower, and raises the right End higher; and the higher it is, the more secure the Plants will be from it; because they are held off by the Limber above.

This way my Turnep-seed has been ho'd, when one would have thought it impossible for a Plough and Horses to go betwixt the Rows without destroying the Crop. Almost in this manner we give our Wheat the last Hoeing, to turn the Furrow a Second time towards the Row. When the Plants of the Rows are very high, the Driver must go in the next Interval, on the Left of the Plough; and the Holder has a Cord, like the Reins of a Bridle, which he lays over the End of the Draw-pin, which keeps it from falling down, until he has occasion to use it for guiding or turning the Thiller.

When we turn the Furrow from the Row (which will then be ever on the left Side of the Plough), the Plough must be set in a very different and contrary Posture;

Posture; but then the Plants commonly being low, there is no Danger of the Whipper's or Limber's hitching or taking hold of them; but the Driver must take care, that he does not tread on them, nor suffer any of the Horses to do so; and they of themselves, when they are not blind, take all the Care they can to avoid it; and I observe, that the Plants are oftener injured by the Driver, than by the Horses.

'Tis in this last-mentioned manner of Hoeing, when we go very near to the young Plants, the First or Second time, that we must take care of burying them with the Earth, which (especially when dry and fine) is apt to run over to the left Side of the Plough; this we can in great measure prevent, when the Ground is clean, by nailing with Three or Four Nails a very thin square Piece of Board to the Sheat, with one Corner bearing at, or below, *a*, in *Fig. 1.* and its other lower Corner bearing on the Back of the Coulter on its left Side at *b*, its upper Corner reaching to *c* or higher; its fore End is ty'd on to the Coulter by a leathern Thong passing thro' an Hole very near the End of the Board. The lower Edge of the Board must come no lower than the prick'd Line *a, b*, which, at *b*, is just even with the Surface of the Ground, before it is rais'd by the Share; for if this Board should be set down too near the Share, the Plough would not go; but, being set in this manner, it prevents the Earth (when never so much pulveriz'd in the driest Weather) from running over upon the Plants to bury them, tho' the Plough go very near them; except in this case, we never use a Board, the Earth running over to the left Side, being often advantageous in Hoeing; for it changes more Surface of the Ground, than if it went all to the right; and when in Summer we hoe from the Wheat-rows, not going very near to the grown Plants, this Earth that runs over the Share to the Left, helps to mend such Places where the Furrow

was not thrown up close enough to the Row by the precedent Hoeing.

The first time we turn a Furrow towards the Row, the Horses go in the Trench near to it, and the Plough stands on the left Side of the Horse-path, almost in the same manner as when the Furrow is turn'd from the Row; but we very often make use of a common Plough, for throwing down the Ridge, which has lain all the Winter in the Middle of the Interval. One Wheel, going on each Side of that Ridge, holds that Plough to a great Exactness for splitting this Ridge into Halves, which the Earth-board, being set out for that Purpose, throws up to the Row on each Side of the Interval.

We also very often make use of the Two-wheel'd Plough, for raising up the Ridges, whereon we drill the Rows; not but that the Hoe-Plough will do every thing that is necessary to our Husbandry: Yet the common Ploughs being heavier than we usually make our Hoe-Ploughs, they by their Weight, and Help of their Wheels go a little steadier: and besides the Ploughmen, being more accusom'd to them, prefer them before all other, where their Wheels are of no Prejudice.

I never saw neater Ridges rais'd by any Plough, than by the Hoe-Plough, nor finer Plowing; and I believe that were it made as heavy, and as strong, it would outdo the Swing-Plough, in plowing miry Clays, where Plough-wheels cannot go; but I, having no such Land, have never made any Hoe-Plough heavy enough for it. However, I am convinc'd, by the many Trials which I have seen, that no other Plough can be used for every Horse-hoeing Operation, so effectually as this I have now describ'd.

The making the Hoe-plough is not difficult for a good Workman; and a few of the Holes for setting the Beam are sufficient, provided they are made in their proper Places, which is impossible for me to describe exactly in a Number that is no more than
 necessary;

necessary ; because the Distance the Plough must go from the Horse-path on either Side, is uncertain, as the Largeness or the Depth of the Furrow is ; and for that Reason, it is as impossible for me direct the Ploughman to the particular Angles, at which his Beam must be set with the Plank, to keep the Share parallel to the Horse-path, as it is to direct a Fidler, how far he must turn his Pegs to give his Strings their due Tension for bringing them all in Tune, which without a Peg to each String could never be done ; but when he has his just Number of Pegs, his Ear will direct him in turning them, till his Fiddle is in Tune ; so the Ploughman by his Eyes, his Feeling, and his Reason, must be directed in the setting his Plough ; but without a competent Number of Holes, he can no more do it than a Musician can tune Four Strings upon one Peg. And I am told, that some Pretenders to making the Hoe-Plough have fix'd its Beam to the Plank immoveable, which makes it as useless for hoeing betwixt Rows, as a Violin with but one Peg to its Four Strings would be for playing a *Sonata*.

Fig. 5. shews the Sort of Yoke, that is us'd on every Ox that draws in a single File, as they always must when they work with the Hoe-plough ; but after they have been accustom'd to draw double (*i. e.* Two abreast) they must be practis'd for about a Week to draw single, before they are set to Hoeing ; for otherwise they will be apt to demolish the Rows, one running off to the right-hand, expecting his Fellow to come up with him on the Left, and another will run off on the Left to make room for his Companion to go abreast with him on the Right, endeavouring to go in the manner in which they us'd to be placed for drawing in Pairs.

I suppose I need not give any Caution about muzzling the Oxen when they hoe ; because they will eat the Plants as soon as they come an Inch above the

Ground, and that will shew the Necessity of it; but there is no occasion to muzzle the Horses until the Plants are grown as high as their Noses, when rein'd up, as in *Fig. 4.*

Fig. 6. is an Instrument of Pulveration, which might have been sufficiently describ'd by its Matter, Weight and Dimensions, without any Portrait, were it not to shew the particular Manner of drawing it, being very different from that of a common Roller, whose Frame is difficult to make, and costly; but this, being only Three Feet long, is drawn by a simple Pair of Limbers, held together, by the Two Bars A and B, firmly pinn'd in at their Ends.

Its Gudgeons must not come out beyond the outer Surface of the Limbers, lest they should take hold of the Plants, when drawn in the Intervals; also the hinder Ends of the Limbers, behind the Gudgeon, should crook a little upwards, for the same Reason.

This Stone Cylinder is Two Feet and an half Diameter, and weighs Eleven hundred Weight besides the Limbers. It must never be us'd but in the driest Weather, when neither the Plough nor Harrow can break the Clods; and then being so very ponderous and short, it crushes them to Powder, or into such very small Pieces, that a very little Rain, or even the Dews (if plentiful), will dissolve them.

I have had great Benefit by this Roller in preparing my Ridges for Turneps. The Weather proving dry at *Midsummer* (which is the best Season for planting them), the Land was in Pieces like Horse-heads, so that there was no Hope of reducing them fit for planting with Turneps that Year; the Clods being so very large, that they would require so many Vicissitudes of wet and dry Weather to slack them; but this Instrument crush'd them small, and the Plough following it immediately, the Ridges were harrow'd and drill'd with very good Success.

I have also made use of it for the same Purpose in the Middle of a cloddy Field, where it pulveriz'd the Clods so effectually, that the Benefit of it might be plainly distinguish'd by the Colour and Strength of the Two following Crops, different from the other Parts of the Field adjoining on both Sides, whereon the Roller was not drawn.

But crushing has such a contrary Effect from squeezing, that if this Roller should be us'd when the Land is moist, it would be very pernicious, by unpulverizing it; of which I am so cautious, that sometimes I let the Roller lie still for a whole Year together.

There is also a long triangular Harrow, which is sometimes useful in the Intervals when the Earth is of a right Temper betwixt wet and dry; but there is no need to describe it, and I scarce use it once in Two or Three Years.

The Diameters of the wooden and iron Pins and Screws, with their Holes, and the Sizes of the Nails to be made use of in all the describ'd Instruments, I leave to the Discretion of the Workmen, who, if they are Masters of their several Trades, cannot be ignorant of such Matters.

Fig. 7. and *Fig. 8.* shew the Lands of Turneps mention'd at the Beginning of this Work.





A N

A P P E N D I X

C O N C E R N I N G

*The making of the DRILL, and the HOL-
P L O U G H, &c.*



O a Workman, who would make these Instruments, I would add the following Directions.

The First thing to be done for making the Drill, is to place half a Sheet of Paper to the Back of Plate 2. by pasting it on to its Margin; and likewise another half Sheet to Plate 3. in the same manner.

Then with a Needle prick through all the Out-lines of A, B, C, and D, in *Fig. 2.* which will mark out both Sides, and both Ends of the Mortise of the Turnep Drill-box. Also prick through the Out-lines of the great Hole in the middle of A, and of the elliptical Hole in B. Also prick the little Hole at E, in A; and at F, in B. Prick through the prick'd Line *p q*, in B; which is the Line to which the Setting-screw *Fig. 6.* or *Fig. 12.* that is to pass thorough the Hole in C, must be parallel.

When the Paper is taken off, cut out of it the said A, B, C, and D, by the Pricks made by the Needle.

Then cut the same in Pastboard, by laying these Pieces of Paper thereon (because Pastboard, being stiffer than

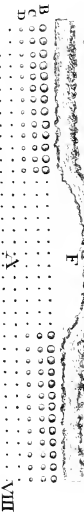
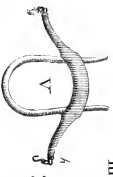
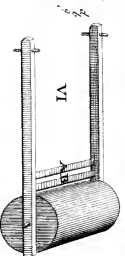
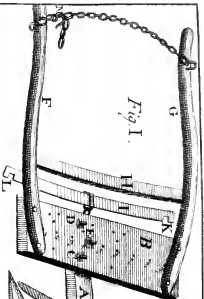

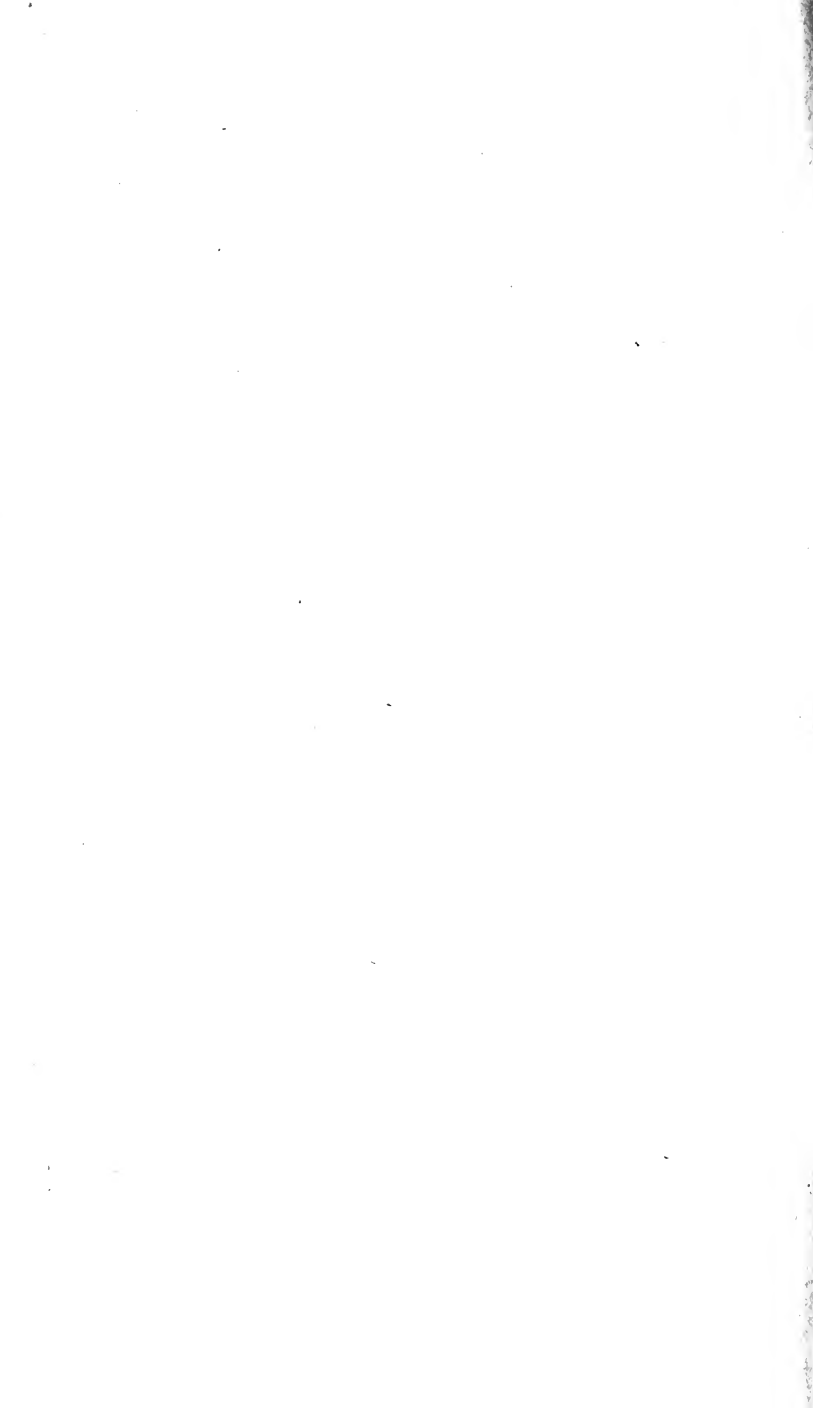

than Paper, will be more fit for the Use). Draw a Line with Ink on the pricked Line, *p q*.

The Hole in C must be something larger than in the Cut, because the Setting-screw must be so, being best to be of Brass, which is less apt to rust than Iron, of which Metal it was formerly made; but Brass, being weaker, requires the more of it to equal the Strength of Iron.

The Wreath, *Fig. 14.* is not necessary, because the Slider, *Fig. 15.* is sufficient without it; but then care must be taken, that the Edges of its Claws A B, which rub against the Cylinder of E, in *Fig. 9.* be taken off, to prevent their cutting it. This Slider is sometimes made of Brass, and sometimes of Iron.

Thus the Workman will have the Sides and Ends of the Turnep-mortise, which make the Whole of it, whereby he may make it exactly in soft Wood.

Fig. 7. called the inner Cylinder, being put into the Cylinder A, of the Steel Tongue, *Fig. 4.* whereby the Holes for the Axis of the Tongue, being the lower from the Top of the Mortise, do not only secure the Edges of the Mortise from breaking out, but also give room for the Flanches B, C, in *Fig. 9.* to be made to reach as far forwards as the Axis of the Tongue, and farther: Hereby the Hole, in the Bottom of the Hopper, may be as wide at the fore End, as at the pricked Line at the Letter B.

The Notches in the Spindle, *Fig. 5.* seem to appear deeper than is usual for Turnep-feed; but I remember I have drilled Furze-seed with a Turnep-drill without altering the Notches. As for the Shape of these Notches, they are so fully described in *Fig. 6.* and *Fig. 8.* of *Plate 3.* that I can add nothing to that Description; only that those being for the Wheat-drill, the Size of Notches for the Turnep-drill must be lesser in some proportion to the lesser Size of the Seed.

For making the Wheat-drill do the same as for the Turnep-drill. The *Fig. 3.* in *Plate 2.* is one Side
of

of the Mortife, by which must be made Two in Paft-board. *Fig. 10. in Plate 2. and Fig. 9. in Plate 3.* are the Two Ends of it.

The Cover that prevents the Wheat from falling down on the hinder Side of the Spindle, is one intire Piece of Brafs, which is marked B in *Fig. 3. of Plate 3.* but the Shape of it, with its Hole whereby it is held in by a Screw, is only seen in the Side, *Fig. 3. of Plate 2.* and there described by pricked Lines; and by pricking through them, the Shape of the End of the Cover may be taken, which Cover is of the same Shape from End to End.

The Joyner who cannot by these Additions, and the Explanations of the *Plates*, make these Drills in Wood, doth not deserve the Name of a Workman.

When he has once made them whole, he can easily make them in Halves like *Fig. 8. in Plate 2.*

By these Halves the Founder will make his Moulds proper for casting them in the best Brafs. But in these Halves for Casting, there must be no other Holes, but the great Holes, and the Hole for the Setting-screw.

The great Hole in the Mould must be largest at E, in *Fig. 9. Plate 2.* and lesser in the Inside in *Fig. 8.* for as it must be of a conical Shape for making the Core, if it should be cast bigger within, when the Whitesmith bores it (as he must) to an exact Cylinder, the End E would be in Danger of bursting by the Force of the Boring, as it is much thinner than in the Mortise. And besides this, if there should be any little Flaw in the Edges of the Hole within the Mortise (which the Founder must avoid as much as possible), it may perhaps be bored out by means of the Hole's being less there. The Hole must be something less in the Mould than its proper Size, even where it is largest; else it may happen, that in boring it to a true Cylinder it may become too big. And I believe, in the Cooling of the Brafs, the Hole grows bigger as the Spindle grows less.

For

For the Hole of the Setting-screw, lay on upon the dark Part of *Fig. 8.* one of the Pastboard-sides; and from the black Line *p, q,* draw a Line coincident to it as on the Brass, for making the half Hole *A* by; and the other Half of it on the opposite Half-side.

These Pastboards will be very useful to the Whitesmith, for directing him to find the Places where the Holes for the Axis of the Tongue, and those for screwing the Two Halves of the Mortise together, are to be made. I advise against boring the great Hole with a Tool (a Bit) with more than Four Edges; for it would be apt to tear the Brass.

The great Hole of the Turnep-drill is bored with Tools like those wherewith a Gun is bored. But the Wheat-drill is bored with a Screw-stock, whose Edges are made sharp for that Purpose, and may be set wider or narrower at Pleasure: It is put into the Hole along with an half-round Piece of Wood, the lower End of the Stock being set fast in a Vice: The whole Seed-box (for it must always be screwed together before it is bored), being put on the End of the Stock (made taper a little way for entering), is turned round it by a long wooden Spanner, which hath a Notch in the middle of it, to receive the whole Seed-box, in order to bore it by turning it round upon the Stock.

The Brass ought to be of the best Sort, which will be easy to file, and yet not mix with baser Metal.

The Seed-boxes may be cast whole by these Moulds; but I prefer those that are screwed together, for several Reasons, which I have not time now to write.

There is a Turnep Seed-box come to my Hands that was made by Pretenders; I wish it is the only one made in the same manner; for it is useless; the Notches in the Spindle are much shorter than the Breadth of the Mortise; at each End of the Notches is a deep Chanel (as deep as the Bottom of the Notches) quite round the Spindle, instead of a Mark, which should be but just visible for cutting the Notches;

and instead of a tender Steel Spring, there is a strong Piece of Iron without Elasticity. By means of this Iron, the Machine grinds the Seed, instead of drilling it.

What I shall here add concerning the Wheat-drill, is some Alterations in *Fig. 21. of Plate 4. viz.* The fore Share and Sheat must be left out for drilling Wheat, no more middle Rows being used. And the Two Beams B B in the Plough, *Fig. 1.* must be set to make Channells Ten Inches asunder. And the double Hopper, *Fig. 15.* must be set nearer together, so as the Seed may fall into the middle of the Funnels of the Beams.

Tho' there is no Necessity of Marking-wheels for guiding the Drill-horse upon Ridges; yet they are very useful for holding the Drill steady, and to prevent its tottering, which without the Marking-wheels, and the fore Hopper, it is apt to do, when the Shares stand so near together as Ten Inches; and on a narrow Ridge one of the hinder Wheels might run off to the Furrow, and draw the Shares after it, if the Drill were not kept steady by the Marking-wheels, and by their Hopper, which takes hold of the single Standard by *Fig. 22.* as is seen in *Fig. 21. in Plate 4.* But there should not be so much room in it on each Side of the Standard, lest the Plough by that means should have too much room to totter, now the Shares are so near together.

The Marking-wheels must be set at the Distance of the Breadth of Two Ridges, which, as we now make them, is about Nine Feet and an half from Wheel to Wheel.

The Brass Box may be taken out of the fore Hopper: And tho' that Hopper be of no Use to the double Row, except as is above said; yet if there should be Occasion to press the Marking-wheels deeper into the Ground for keeping the Plough the more steady in its Course, it may be usefully filled with Earth, or other Matter, sufficient for that Purpose. And besides,

rides, it may serve to plant Three Rows of St. Foin, when the fore Share and Sheat are put in, and the Beams and hinder Hopper set a Foot or Eighteen Inches wider, and the Marking-wheels at their due Distance, as is directed in the Essay. Thus the same Drill may plant Wheat and St. Foin.

A Drill for the double Rows might be made with a single hinder Hopper, instead of the double one. And there is a Contrivance to supply the Use of the fore Hopper for keeping the Plough steady, and more easy to make than that Hopper; but this cannot be described by Words without Cuts.

The Lime wherewith the brined Wheat is dried, receiving some of the Salts from the Brine, will stick in the Notches of the Spindle; yet never makes any Stoppage to their Delivery of the Seed; but every Year we clean the Notches from the Lime with a Chiffel, and, if it were done oftener, it would not be amiss.

There is an Accident that may possibly happen, but never to a careful Driller; *viz.* a large Clod may some way be thrown into a Funnel of the Beam of the Plough, either by a Wheel, or by the Paddle that cleanses the Sheats from the Dirt that sticks to them when the Earth is wet. This may stop the Wheat from falling out of the Funnel into the Trunk; and then, so far as the Plough goes thus stopped, the Chanel will have no Seed in it; but the Driller that follows may take it out immediately, which if he should neglect to do for never so little a Distance, he ought to stop the Plough whilst he supplies the Chanel with Seed from his Hand as far as it is empty. When there is any Danger of this, as in very rough cloddy Ground, it is best to take off the Drill-harrow, to the end that the Chanel may lie open for receiving the Seed from the Hand. But if the Ends of the Hopper reach below the Funnels, and they are otherwise defended, as they may be, this Accident can never happen.

When

When the Drill-harrow is taken off, the best way for taking up the Plough to turn it, is to bore a Hole of about half an Inch Diameter in the End of each Beam behind the Funnels, and fasten a Withe into these Holes; by which Withe the Driller very conveniently takes hold with one Hand, and lifts up the Plough, laying his other Hand on the Hopper to keep it steady. This Method of taking up the Plough hath been often used for the Wheat-drill, and for the Turnep-drill; and in the latter the Hole in the one Beam holds the Withe as well as do the Two Holes in the former.

There are new Editions of some of these Engines, which cannot be fully described without more *Plates*; but since those already described are found by Experience to be sufficient for the Purposes they were designed for, new Editions of them are not necessary, tho' convenient in many respects.

Reason will easily make Additions to the Instruments when they are necessary; as when more than one Brass Spindle is to be turned by one or each Wheel for planting Clover amongst Barley after it is come up. 'Tis done by a very light Plough, drawn by a Man: It plants Four Rows at once Eight Inches asunder: The Shares are very short and narrow, and so are the Sheats and Trunks. 'Tis not difficult to put on a Crank at the other End of the Brass Spindle, in the same manner that the Handle that winds up a Jack is put on, and to fasten it at the Hole at I in *Fig. 5.* of *Plate 2.* This Crank must, at its first turning, before it turns up towards the Letter H, of the same *Fig.* be long enough to reach to within an Inch of the Fork of the Second Spindle. Thus each Wheel may turn several Spindles, and then this Drill may plant many Rows of Seeds at once.

When you plant Rows nearer together than Eight Inches, it is best that the Plough have Two Ranks of Shares and Hoppers, else the Earth may be driven
before

before the Shares; but with Two Ranks of them, they will not be more apt to drive the Earth before them in making Rows at Four Inches asunder, than at Eight, when there is only a single Rank of Shares.

But I think this near Distance of Four Inches cannot be proper for any Sort of Seeds, except Flax-feed; and even for that Seed not necessary. If the Land be made fine, a single Rank of Shares will go very well to plant Rows at Seven Inches asunder.

I had formerly a Drill-Plough for drilling across very high round Ridges for Hand-hoeing, where Horse-hoeing is impracticable: It had no Limbers; but it had little Ground-wrists to make open Channels, and had Handles behind it, whereby the Driller raised up the Tail of the Plough, when it was passing the Summit of the Ridge. There were neither Funnels nor Trunks; for these would hinder the Seed from falling into the Channels, both by the Plough's going up and down the Ridge. The Hopper was drawn by the Plough in such a manner, that in passing all Parts of the Ridge the Wheels were not raised from the Ground: The Channels were equally supplied with Seed throughout: It planted Four Rows at once, at a Foot asunder. I used this Drill-Plough 30 Years ago in *Oxfordshire*: I have no such Ridges here, nor consequently any Occasion of such an Instrument; and did not make Cuts of it, because it is not useful for Horse-hoeing. I only mention it here for the Benefit of those who have a mind to plant such Ridges regularly with an Engine: I hope their own Reason will enable them to contrive such a Plough, especially now they have the manner of making the Drill, Hopper, &c. shewn to them.

I have made a very material Addition to the Hoe-Plough, of *Plate 6. viz.* At the fore End of the Beam *Fig. 2.* is the Hole I, by which alone let the Plough be drawn, leaving out the Hole H; instead of the Hole G make a Mortise, Three or Four Inches long,

long, and as broad as the Thickness of the Iron Pin, the End and Nut of which are seen at C, in *Fig. 1.* This Pin should be more than half an Inch Diameter, and square at that End that goes into the Mortise; let the hinder End of the Mortise just appear behind the Plank, when the Beam is at right Angles with it.

By means of this Mortise there may be many more Holes through the Plank without Danger of splitting into one another the Holes in the Beam, which must answer those in the Plank.

Draw many Lines from the Middle of the foremost Hole of the Plank to the hinder Edge of it, at (suppose) a quarter of an Inch from one another there; and then bore a Hole in that Part of each Line that is least apt to break into the next Hole to it.

Every System of Holes in the Plank will have like Benefit of being increased in their Number by the Convenience of this Mortise; without which it is impossible to have so great Variety of turning the Point of the Share to make the Share go parallel to the Horse-path.

The Board described in *p. 403.* we now use very seldom in Hoeing of Wheat.

Explanation of Plate VII.

FIG. 1. shews the Plank and the Harrow of the latest and best Drill-plough, most simple, and accommodated to the present Practice of planting double Rows.

A is the Plank, with all its Mortises and Holes; *b* is the Mortise into which the Tenon of the fore Sheat of the Drill-plough, for planting treble Rows, was fastened; *d* is the square Hole for receiving the Seed from a Hole of the same Shape and Size in the Bottom of the Funnel.

When the Sheat is taken out of the Mortise *b*, and another Sheat is made exactly the same with that, place them in the Mortises *a a*, and make the Two square

square Holes *c c* behind them, for their Funnels to stand on. Make the Mortise *e*, which is to hold the single Standard that is to hold up the fore Hopper in the treble Drill, and in this to guide the Wheels also, instead of Wreaths, that in the treble Drill are put on the Spindle bearing against the Insides of the double Standards; for in this the Shares being but Ten Inches asunder, and at such a Distance from each of the Wheels, that neither of them doth by rising lift up a Share perceptibly; but if the Shares were wide asunder, or there were more of them reaching nearer to the Ends of the Plank, a Wheel might rise up, and lift a Share out of the Ground, if guided by the single Standard and Hopper, as in this. The single Standard is shewn in *Plate 4. Fig. 10.* but this has no Fork at its Bottom, as that has. This has only a single Tenon, and is shouldered before, behind, and on each Side, to hold it the more firm and steady, when tightly pinned down by Two Pins underneath the Plank. The Dimensions of this Standard are the same with those of the other; but the Shoulders must not increase the Thickness of the Standard any higher than the Tops of the Funnels.

The Four other square Holes, *viz. f* with another behind it, and *g* with one before it, are for the double Standards, which are to be well shouldered, or braced on the Side of each that is next to the End of the Plank, and on the Outside. There is no need of Shoulder or Brace on the Sides where the Spindle is placed, or on the Side next to the Middle of the Plank.

The Four round Holes *b i k l* are those thro' which the Four Pins pass that hold on the Limbers, and the Piece *A*, in *Fig. 2.* and the other of the same Sort in *Fig. 4.*

Fig. 2. and *4.* shew how the Harrow's Leg *B* is held to the Piece *A*, by the Pin *C*. The Letters *a b* shew the Holes through which the Pins do pass to

screw the Piece A up to the Plank, and the Limbers for guiding the Harrow. This Piece A is somewhat longer than the Breadth of the Plank; it is about Two Inches thick, and Two and an half in Depth. The Pin *Fig. 3.* goes through this Piece near the Bottom of its fore End, whereby the Harrow tines have the more room to rise up, without being held down by the Legs pressing against the Plank.

Fig. 3. is the Pin C, of *Fig. 2.* *a* is its Head, *b* its round Part, whereon the Harrow moves; *c* is its square Part, that prevents its turning, which by the Motion of the Harrow would unscrew the Nut *d*, and cause it to come off of the Screw *e*, and be lost.

The Harrow is also shewn in *Fig. 1.* as it is guided by the Pieces before described: B is its Head, that holds the Tines D D, drawn by the Legs C C. Tho' these Legs *in Plano* seem in their Middle to crook sideways, yet when out of Perspective, their Middles crook only downwards; which is to give the greater Length to the Tines, and the more room for them to move up.

Fig. 5. is the Spindle in Three Parts. A is the middle Part, wherein are the Notches *b b*. This is best to be of Oak, or some other hard Wood, in which the Edges of the Notches are less apt to wear than in softer Wood; but I have had a Set that have lasted the Drilling of 120 Acres, when made of Ash. B and C are the Two other Parts: D and E are their Ends, whereon the Wheels are put. The Holes *b b b b*, and the same in the other End under the Letter E, are for setting the Wheels at different Distances, in order for making new Notches, or for different-sized Ridges: The Wheels are held in their Places by long Nails put through some of these Holes, and clenched upon the Iron Stock-bonds to prevent their falling out. These Ends B and C need not be cut to a Square; except just enough to prevent the Wheels from turning on the Spindle.

These

These Three Parts are grafted together by Help of the hollow Cylinder *Fig. 6.* which, being put on upon the Joint *f*, of the Spindle *Fig. 5.* holds the Parts A and B together by the Two Pins *a a*, passing through the Cylinder near its Ends, and through the Holes *k* and *g*.

This Joint may be in another manner; *viz.* One Part of the Spindle may enter into the other by cutting it to a square Peg of an Inch long, and 3-4ths Diameter, entering an Hole that fits it, at the End of the other Part.

These Pins will be best to have Screws at their Ends with Nuts to them; and then they need not be so tight in the Holes, and may be the more easily taken out, when the Part B is to be taken off for avoiding Obstructions in drilling an outside Ridge.

The Cylinder is a Foot long, and about half an Inch thick, bound with an Iron Ferrel at each End; and if there were another in the Middle, it might be the stronger.

Place the Cylinder on the Outside of the Spindle, the Joint *f* being exactly against the Middle of the Cylinder; and mark at each End of it, in order to see when it is in its right Place; and after it is put on and pinned, mark likewise on the Spindle the exact Places of the Holes, for the more easy finding them every Time the Cylinder is put on.

Another Cylinder must be on the Joint *c*, held together by Pins passing thro' the Holes *i* and *d*, in the same manner, and for the same Purpose, as the other Joint already described.

The Spindle ought to be of equal Diameter with the Bore of the Seed-boxes, thro' which it is to pass; but this I find, needs not be quite an Inch and 3-4ths; it may want an 8th of it, even in this long Spindle.

Fig. 7. is one of the Pins which hold the Cylinder in its Place, as has been said; *a* is its Head; *b* the Stalk, which would be better to be a Screw at its

lower End, whereon to screw a Nut; but then the Stalk must be square at the Head.

Fig. 8. is a Sheat with its Trunk and Share of the Drill-plough, which has been described in *Plates 4.* and *5.* but the Shape of the Share, as it rises at the Socket, is more plainly seen in this Figure.

Fig. 9. is the whole Wheat-drill, which at present I use for planting the double Row. A is the Hopper, rising and sinking on the single Standard B, which holds it up. C is the thing like the Carrier of a Latch, described by *Fig. 22.* in *Plate 4.* I need say no more for describing this Drill, than to shew how it differs from that described in *Plate 4.* *viz.* This Hopper has Two of these Carriers, the one near its Top, like the other; and another near its Bottom, which keeps the Plough from rising at either End, without the rising of either End of the Hopper, which is no Inconvenience here; because the Two Shares, being but Ten Inches asunder, are almost the same as one; so that at the Distance the Wheels stand from each other, the rising of one Wheel doth not lift up the Share that is next to it perceptibly; as it would do if the Shares were farther asunder, or the Wheels nearer together.

This Hopper holds twice as much Seed as the single fore Hopper did, *viz.* half a Bushel; and is divided into Two equal Parts by the Partition *e*, whereby the Driller sees whether the Seed is discharged equally; and if he perceives that one Part of the Hopper runs out faster than the other, he must adjust them by the Setting-screws.

The Funnels *a a*, which receive the Seed from the Hopper, and convey it down into the Trunks *c c*, appear under the Hopper, as doth also Part of the Hole *d*, whereon the Funnel stood when the fore Hopper was single. D shews the Cylinder upon the grafted Spindle at one End, as F shews where the other End with its Cylinder and Wheel is taken off.

The Ends of the Piece A, which guide the Harrow, appear behind the Plank at *ff*. At *g* in the Harrow-head is a Hole exactly in the Middle between the Tines, for tying on a Stone when the Harrow is too light for the Soil. *Note*, This Hole must follow exactly after the Middle of the Plank, *i. e.* between the Two Shares at an equal Distance from each.

Observe, that the Legs of this Harrow go thro' the Head on the Outsides of the Tines, as in the treble Drill they go thro' on the Inside of the Tines. Instead of the wooden Tines, may be put in common Iron Tines of a proper Length.

The Two Hooks whereby the Plough is drawn are at *b b*. 'Tis best for the Ends of the Hooks to turn upwards, so that the Links of the Chain-traces, that are to be put on them, may not be apt to drop off. Take care that these Traces be of an equal Length, which may be easily made even by the Links that are put on these Hooks.

Note, The Links of the Piece of Chain, whereby the Plough is made to go deeper or shallower, may be very small, and by no means in the Proportion they bear to the Limbers in the Cut. There need not be above Four or Five Links. If there be occasion to raise or sink the Limbers more than that Number will reach, the Cord may be tied longer or shorter on the other Limber. And when there is not the Convenience of Chain-traces, they may be supplied by a few Iron Links at the Ends of Hempen Traces.

Fig. 10. is the Shape of a wooden Wreath, which (when the Shares stand wider asunder, or when there are more than Two of them, so that they come nearer to the Ends of the Plank, this Wreath) is necessary to be put on the Spindle, the End *a* bearing against the Inside of the double Standards, and the End *b* being towards the Hopper. 'Tis fixt to the Spindle by the Screw *c*, which should not enter the Spindle above half an Inch deep. There may be another like Screw

to enter in the same manner on the opposite Side of this Wreath. There must be in this case another Wreath the same of this to bear against the other double Standards. And when these Wreaths are used, the Hopper must have only the upper Carrier C; the lower one must be taken off. But in this our Drill for planting Wheat, no Wreaths must be on the Spindle, except those at *b b*, which are to hold the Hopper from moving endways. And these may be of the Sort above described, the End *a* bearing against the Hopper.

Fig. 11. is the Beam of the Hoe-plough described in *Plate VI. Fig. 2.* with no other Alteration than leaving out the Hole H, and the pricked Line between it and the Hole I; and changing the Hole G into a Mortise. The pricked Line *a b* represents the hinder Edge of the Plank, behind which appears a very small Part of a Mortise. See *p. 415, 416.*

Fig. 12. is the Plank, which is *Fig. 3.* in *Plate VI.* The Improvement of it in this Figure is described in *p. 415, 416.*

An Appendix to Chap. IX. of Wheat, p. 138. containing Memoranda for the Practisers of this Husbandry.

AT the Second Hoeing the Plough goes in the Furrow of the First, making it deeper, and nearer to the Wheat. The Third Hoeing fills up this Furrow; and then, at the Fourth Hoeing, the Plough goes in the same Place as the Second, turning the Mould into the Interval. 'Tis remarkable that though the Furrows of the Second and Fourth Hoeings be deep, and near to the Rows, seeming to deprive the Wheat of the Mould which should nourish it, whereby one would imagine, that these Furrows lying long open should weaken or starve it; yet it is just the contrary; for it grows the more vigorous: And it is the Observation of my Ploughmen, that they

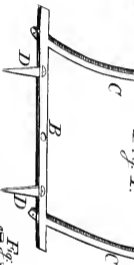
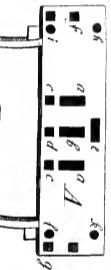
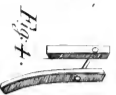

Fig. 7



Fig. 8.



Fig. 10.

Fig. 12.

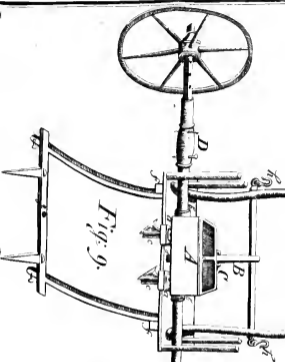

Fig. 9.



Fig. 11.

Invented & Designed by R. Pritchard for J. Fitchell Esq. Oct. the 25th 1738



they cannot at these Hoeings go too near to the Rows, unless the Plough should tear out the Plants.

If I may presume to assign the Cause of this surprising Effect, it is, in my Opinion, the following; *viz.* This open Furrow has a double Surface of Earth, which by the *Nitre* of the contiguous *Atmosphere*, is pulverized to a great Degree of Minuteness near the Row. The Roots that the Plough cuts off on the perpendicular Side of the Furrow, send out new Fibres to receive the *Pabulum* from this new-made Pasture; and also Part of this superfine Powder is continually falling down into the Bottom of the Furrow, and there gives a very quick Growth to those Roots that are next it, and a quick Passage through it into the Earth of the Interval, where they take likewise the Benefit of the other Side of this pulverized Furrow. When it is said, that Air kills Roots, it must not be understood, that it kills a Plant, unless all, or almost all, its Root is exposed to it, as it is not in this Case. Some think there are Roots that run horizontally below the Plough into the Interval; but of this I am not convinced.

'Tis not often that we hoe above Four times; and then the Furrow is turned towards the Row at the Third time only.

There being no Danger from these Furrows lying long open, we are not confined to any precise Distance between the times of Hoeing, for which we need only regard the Weather, the Weeds, and our own Convenience of Opportunity and Leisure.

'Tis an Advantage when these Furrows lie open on each Side of the double Row till Harvest; for then there need only Two Furrows to be plowed on a Ridge to throw down the Partition in order for planting the next Crop; but if at the last Hoeing the Furrows are turned towards the Row, they must be plowed back again after Harvest before the Partition can be plowed: This requires double the time

of the other ; and the sooner the Partitions are plowed, the more time they will have to be pulverized before they are replanted. Indeed this Advantage is only when the Rows are to be planted where they were the Year before ; for this is rather a Disadvantage when they are to be planted in the Intervals. Whether these Furrows lying long open next the Rows in very hot dry Climates may be prejudicial, cannot be known, but by Trials.

As from the external Superficies of an Acre of Pasture on a rich Soil, Animals take more *Pabulum* than of an Acre on a poor Soil ; so Vegetables take more *Pabulum* from the internal Superficies of a rich Acre than of a poor one ; the Pulveration, or Superficies of Parts, being equal. See p. 44, 45. From whence there is no Encouragement for making Trials on very poor Land.

'Tis no great Matter whether the Rows are drilled on the Partitions, or the Intervals ; for the Crops of a Field, Four Years successively drilled on the Partitions, were very good. After the Partitions had been plowed, and lain open till the Weather made them pulverizable by the Harrows, and then turned together by Furrows larger than those which opened them, much Earth of the Intervals was mixed with them. This is the strongest and lowest Ground I have ; and if there should be much wet Weather after Harvest, it is so long in drying, that we take the first Opportunity the Weather allows for planting the Wheat, which is generally done in the above manner, because it is the shortest ; but, without some such Reason to the contrary, I prefer planting the Rows on the precedent Intervals.

My Field, whereon is now the Thirteenth Crop of Wheat, has shewn that the Rows may successfully stand upon any Part of the Ground. The Ridges of this Field were for the Twelfth Crop, changed from Six Feet to Four Feet Six Inches : In order for this Alteration,

Alteration, the Ridges were plowed down, and the whole Field was plowed cross-ways of the Ridges for making them level; and then the next Ridges were laid out the same way as the former, but One Foot Four Inches narrower; and the double Rows drilled on their Tops, whereby of consequence there must be some Rows standing on every Part of the Ground, both on the former Partitions, and on every Part of the Intervals: Notwithstanding this, there was no manner of Difference in the Goodness of the Rows, and the whole Field was in every Part of it equal, and the best, I believe, that ever grew on it. It has now the Thirteenth Crop, likely to be very good, tho' the Land was not plowed cross-ways.

The proper Times for Plowings and Hoeings depending upon the Weather, and other Circumstances, cannot be directed but by the Reason and Experience of the Practiser, as has been said.

The Number of Ridges being increased, as their Breadth is now diminished, occasions somewhat the more Plough-work; we likewise use more Hand-work than formerly; but the Profit of this increased Labour is more than double to the Expence of it.

The Decline of the Woolen Manufacture furnishes us at this time with Plenty of Hand-hoers and Weeders; because they can earn much more by working in the Field than by Spinning at home.

'Tis better to make Fifteen Ridges on an Acre, than to leave any Earth unmoved by the Hoe-plough in the Middle of the Intervals; but when Ploughmen, by Practice, understand well to use the Hoe-plough, they will plow the Intervals clean, tho' the Ridges are only Fourteen on an Acre.

Bearded Wheat is in this Country called *Cone*, and that which has no Beard *Lammas*. I observed formerly the Bread of *White-cone* had a little yellowish Cast, which I now suspect was from the Mill-stones; for I have seen it be very white these many Years, since the
the

the Millers know better how to grind this Wheat. Cone-wheat Westwards yields Six-pence a Bushel more than *Lammas*; but towards *London* the contrary.

The Reasons why a whole Field of Wheat doth not produce a Crop equal in proportion to a Yard or Perch cut, rubbed out, and weighed immediately upon the Spot, may be, because the Grain of the Field lying to sweat in the Mow, loses considerably of its Weight and Measure. There is also some lost in the Field by Reapers, and by Leafers; and some is by Threshers thrown out of the Barn; and some of them are found to have Contrivances to carry home with them at Night, Part of the Wheat they thresh in the Day. I say nothing of those Thieves, who in Harvest rob the Field in the Dark; tho' they are not very uncommon.

I missed of making my proposed Experiment of the single Row, after I had prepared for it by plowing out one of the double in several Places for that Purpose; but, in the Hurry of Harvest, they were cut together with the rest, without making any Trial; as should have been made, if my Illness had not prevented my Attendance in the Field at the time of Reaping.

The Practice and Instruments that are left off for better in their room, as the Quadruple and Treble Rows, &c. are still useful to be shewn, in order to deter others from going into an inferior Method that is now exploded; for some might think it an Improvement of the double Rows, &c. by their own Invention, if they should not know it had been already tried.



I N D E X.

*A*rtificial Pasture of Plants exceeds the Natural p. 27, &c.
*A*tmosphere, by Rain and Dews, reimburses the pulverized Earth - - - - - 70, 127

B

Barley, a hoed Plant of it produced Fifty large Ears 65
Barley drilled on Ridges must be reaped - - - 63
 But needs not be bound up in Sheaves - - - *ibid.*
Barley is the worse for Seed by being sown at *Patney* 240
Blight, the true Causes of it - - - 144, &c.
 Remedies against the *Blight* - - - 149, &c.
Breast-Plough insufficient for Tillage of strong turfy Land 284

C

Change of Species of Plants not necessary on account of different Nourishment - - - 217, &c.
 Change of the Individuals of some Species of Plants, why useful - - - - - 239
Clover, Broad, a Damage to *Barley* when sown amongst it 188
 A Remedy against it - - - - - *ibid.*
Cytisus, why it cannot be so great an Improvement in *England* as *St. Foin* - - - - - 172

D

Dung, in what manner 'tis beneficial - - - 29, &c.
Dung is the Putrefaction of Earth altered by Vessels 31
 It may afford some Warmth in Winter, but is sometimes injurious by its Hollowness - - - 34
 A considerable Quantity of *Dung* is necessary to the Old Husbandry, but not to the New - - - 33
Dung, when reduced by a thorough Putrefaction, is next to nothing - - - - - 275
 Why *Dung* is not injurious to *Corn*, &c. - - - 33
Dung,

Dung, why more beneficial to Turneps than to other Plants	- - - - -	88
Gross Dung, why it should be prohibited the Kitchen-Garden	- - - - -	30, &c.
E		
<i>Earth</i> , the Price of a Foot of it, and of a Row	124, 125	
Particles of Earth much more heterogeneous after passing Vessels	- - - - -	237
<i>Effluvia</i> of Animal Bodies noxious	- - - - -	32
<i>Equivocal Generation</i> disproved	- - - - -	78, 79
<i>Exhaustion</i>	- - - - -	270, 271
F		
<i>Food</i> , or <i>Pabulum</i> of Plants, what it is	- - - - -	15, &c.
<i>Frost</i> , how it is advantageous	- - - - -	116
<i>Furrow</i>	- - - - -	114
Furrows lying long open next the Rows of Wheat beneficial; and the Cause of it	- - - - -	422, 423
G		
<i>Grass</i> , natural, why not killed by constant Feeding	- - - - -	187
H		
<i>Harrowing</i> , how injurious	- - - - -	46
Of harrowing Wheat-Ridges	- - - - -	100, 101, 103
<i>Heat</i> , the very least Degree of it hard to distinguish from the very least Degree of Cold	- - - - -	34
<i>Hills</i> , Mr. <i>Bradley's</i> quibbling Arguments about them answered	- - - - -	248
Wet Hills made dry by plowing them cross the Descent	- - - - -	241 — 247
<i>Hoeing</i> in general defined	- - - - -	47
Its Uses and Benefit	- - - - -	47 — 73
The Error of fancying that Hoeing lets in the Drought	- - - - -	52
Hoed Plants do not impoverish Land, as sown Plants do	- - - - -	71
<i>Horse-hoeing</i> : Mr. <i>Evelyn's</i> Observation of an Orchard, kept in Tillage, coming to Perfection in half the time of one not plowed	- - - - -	57
Horse-hoeing supplies the Use of local Motion to Plants	- - - - -	64
It equals Dung	- - - - -	70, 94, 269
Its Benefits discovered by Change of Colour of the Plants next to it	- - - - -	51
Comparison of it with Hand-hoeing	- - - - -	49
Some general Directions for performing the Horse-hoeing	- - - - -	
Husbandry	- - - - -	57, &c. 114, &c.
I		
<i>Interval</i> , what it is	- - - - -	61
Wide Intervals	- - - - -	72, 122, &c.

The Reason why Intervals may be narrower for Barley than
for Wheat - - - - - 63

L

Land strong and light - - - 38, &c.
 No one Arable Land exceeds another above twenty times
 in Richness - - - - - 44
 Land burnt becomes next to barren - - - 40
 Land without Cement is unfit for Tillage - - 44
 Land that is unfit for Horse-hoeing - - - 72
Luzerne described - - - - - 193
 The Goodness of *Luzerne* - - - - - *ibid.*
 The Antients Superstition concerning it 194, &c. 210, &c.
 Swelling of Cattle by eating *Luzerne* when green 194
 Why *Luzerne* is more proper for the Hoeing Husbandry
 than the common Husbandry in *England* 199, &c.
 The Soil most proper for *Luzerne* - - - 204
 Directions about planting *Luzerne* - - - 205, &c.
Luzerne decays as natural Grass increases amongst it 197,
 &c. 213

M

Mints, several Experiments made on them - - 8, &c.
 Observation upon those Experiments, and Inferences from
 them - - - - - 11, &c.

N

New and Old Husbandry, the Differences between them
 254, &c.

O

Objections likely to prepossess People's Minds against making
 Trials of the Horse-hoeing Husbandry answered 64,
 &c. 129, &c.

P

Pasture of Plants described - - - - - 22, &c.
 How the Vegetable *Pasture* differs from the Vegetable
Pabulum - - - - - 22
 The artificial *Pasture* of Plants vastly exceeds the natural
 27, &c.
Plants, annual, that live the longest, have most need of hoe-
 ing - - - - - 92
 They are more altered, as to their Growth, by Culture
 than by Climate - - - - - 204
 There is no need to change the Species of Plants in Hus-
 bandry, on account of their supposed different Nourish-
 ment - - - - - 214, &c.
 Dr. *Woodward's* Arguments for the vulgar Opinion in this
 Matter answered - - - - - 214, &c.
Mr.

Mr. <i>Bradley's</i> Arguments for the same vulgar Opinion answered	- - - - -	222
Mr. <i>Bradley's</i> Arguments from the perpendicular Growth of Plants answered	- - - - -	66, &c. 228, &c.
Why long tap-rooted Plants do not succeed so well after one another, as they do after those that are not tap-rooted	- - - - -	232
<i>Individuals</i> of several Species (or Sorts) of Plants, are beneficially changed	- - - - -	238, &c.
<i>Partition</i> , what it is	- - - - -	61
The Width of Partitions in the latest Practice	- - - - -	108, &c.
<i>Ploughs</i>	- - - - -	277, &c.
Hoe-Plough	- - - - -	394, &c.
Q		
<i>Quick-lime</i> for drying of brined Wheat to drill	- - - - -	141
R		
<i>Ridges</i> , the Methods and Reasons for making them	- - - - -	241
Ridges of Six Feet, Reasons for leaving them off	- - - - -	108, &c.
<i>Roller</i> , when injurious	- - - - -	46
<i>Rocks</i> , to prevent their Damage	- - - - -	107, &c.
<i>Roots</i> , their Description	- - - - -	1, &c.
Several Ways to discover their horizontal Extent	- - - - -	2, &c.
The Cause of People's being deceived in the Extent of Roots	- - - - -	5
Great Length of Roots necessary, on account of their Office	- - - - -	7
How Roots and Guts agree, and wherein they differ	- - - - -	6, &c.
How Roots take in the <i>Pabulum</i>	- - - - -	41
Roots have a Communication in all their Cavities	- - - - -	13
Roots supply each other reciprocally with Water and Food	- - - - -	<i>ibid.</i>
Roots cannot easily penetrate, unless the Land be opened by Tillage	- - - - -	6
The Rotting of the Roots of broad Clover, and St. Foin, is a Manure to Land	- - - - -	234
<i>Rows</i> , the Inconveniencies of too many or too few on an Acre	- - - - -	122, &c.
Reasons for leaving off the middle Row	- - - - -	108, &c.
'Tis no great Odds whether the Rows of Wheat, &c. stand on the precedent Partitions, or the Intervals	- - - - -	424
Rows too near, and mixed Crops, discarded	- - - - -	62
Single Row proposed for <i>Smyrna</i> Wheat	- - - - -	136, &c.
Double, Treble, and even Quadruple Rows, are each called One Row	- - - - -	62
		S St.

S

<i>St. Foin</i> , its Description and Names	-	-	157
Directions for planting and ordering it	-	-	159, &c.
<i>St. Foin</i> , and other long tap-rooted Plants, suffer more by their Pasture's being overstocked, than other Plants do	-	-	167
Directions about <i>St. Foin</i> Hay	-	-	173, &c.
Quantity of <i>St. Foin</i> on an Acre	-	-	186
Why <i>St. Foin</i> makes a forty times greater Crop on poor Land, than its natural Grass or Turf	-	-	157
Directions for saving <i>St. Foin</i> Seed	-	-	178, &c.
Of feeding <i>St. Foin</i> by Sheep	-	-	187
<i>St. Foin</i> Plants not killed by cutting off their Heads	-	-	188
<i>St. Foin</i> takes Nine Parts in Ten of its Nourishment below the Staple of the Land	-	-	191
Of breaking up old <i>St. Foin</i>	-	-	189
Great Improvement made on Arable Land by <i>St. Foin</i>	-	-	188, &c.
<i>Sarrition</i>	-	-	53, &c.
<i>Seeds</i> , in their natural Climate do not degenerate	-	-	238, &c.
Causes why <i>Seeds</i> , as to their Individuals, do degenerate	-	-	<i>ibid.</i>
How to know the most proper Depth to plant all sorts of <i>Seeds</i> at	-	-	58, &c.
Some sorts of <i>Seeds</i> come in the Air, or by Birds	-	-	78
<i>Sheep</i> , how injurious to drilled Wheat	-	-	149
<i>Smuttiness</i> of Wheat	-	-	139
The Causes of <i>Smuttiness</i>	-	-	<i>ibid.</i>
The Cure of <i>Smuttiness</i>	-	-	<i>ibid.</i> &c.
<i>Soils</i> differ chiefly in respect of Heat and Moisture	-	-	20, 21
A Soil can be exhausted by nothing but Roots	-	-	276
There is no way for us to enrich a Soil but by Pulveration, and keeping it from being exhausted by Vegetables	-	-	<i>ibid.</i>
<i>Stratum</i> : The <i>Under Stratum</i> of light Land may be richer than that of strong Land	-	-	191, 238,

T

<i>Tillage</i> beneficial to all Sorts of Land	-	-	36, &c.
<i>Tillage</i> can never make Land too fine	-	-	44
<i>Tillage</i> of the low Vineyards	-	-	56, &c.
Insufficient <i>Tillage</i> , how 'tis injurious	-	-	40
<i>Tillage</i> can pulverize as well as Dung	-	-	35, &c.
The Plough, in Field-tillage, why preferable to the Spade	-	-	280
The same Quantity of <i>Tillage</i> will produce the same Quantity of Food, &c.	-	-	230, &c.

Transf.

<i>Transplanting</i>	- - - - -	48
<i>Trees</i> , the Damage they do to Crops is by robbing, as Weeds only	- - - - -	74
The Reason why some sorts of Trees endure hard Winters better in <i>England</i> than in <i>Languedoc</i>	- - - - -	202
<i>Trials</i> unexpensive proposed	- - - - -	133, &c.
<i>Turneps</i> , the Soil most proper for them	- - - - -	79
Directions concerning them	- - - - -	80
Advantage of drilling and horse-hoeing of Turneps	<i>ibid.</i>	
Several manners of spending Turneps by Sheep	- - - - -	90
V		
<i>Veerings</i> and Hentings	- - - - -	123, &c.
<i>Vineyards</i> owe their great Products to the Hoe-tillage; and from them the Author first took his Scheme	- - - - -	56, &c.
W		
<i>Water</i> , how injurious, and how beneficial, to Wheat	- - - - -	97
<i>Weeds</i> , their Definition	- - - - -	73
Weeds pernicious in several respects	- - - - -	<i>ibid.</i> &c.
Their Robbing proved by Experiment	- - - - -	74
Why the Race of Weeds cannot be extirpated by the common Husbandry	- - - - -	75
The Race of Weeds most likely to be extirpated by hoeing	- - - - -	77
Weeds cannot be killed before they grow	- - - - -	129
<i>Wheat</i> , why it requires hoeing more than Spring-Corn	92, &c.	
Directions about drilling and hoeing of Wheat	<i>See Chap. ix.</i>	
How a Wheat-Crop is augmented	- - - - -	119, &c.
Of feeding Wheat by Sheep	- - - - -	148, &c.
Wheat Ears will be large or small, in proportion to the Nourishment given to their Plants	- - - - -	119
Wheat-ears do not lodge, by reason of their Weight	- - - - -	148, 149
Of weighing the Product of a Yard or Perch of a Row of Wheat	- - - - -	129, &c.
Cone Wheat and Lammas Wheat, their Difference	- - - - -	425
<i>Smyrna</i> Wheat	- - - - -	104, 136, &c.
Of keeping of Wheat by drying it	- - - - -	131
Some Land unfit for Wheat	- - - - -	117
The time proper for Hand-hoeing of Wheat	- - - - -	132
<i>Winter</i> , what time is meant by it	- - - - -	115

